

SN54ACT16373, 74ACT16373 16-BIT D-TYPE TRANSPARENT LATCHES WITH 3-STATE OUTPUTS

SCAS122C – MARCH 1990 – REVISED SEPTEMBER 1996

- Members of the Texas Instruments *Widebus™* Family
- Inputs Are TTL-Voltage Compatible
- 3-State Bus Driving True Outputs
- Full Parallel Access for Loading
- Flow-Through Architecture Optimizes PCB Layout
- Distributed V_{CC} and GND Pin Configuration Minimizes High-Speed Switching Noise
- *EPIC™* (Enhanced-Performance Implanted CMOS) 1- μ m Process
- 500-mA Typical Latch-Up Immunity at 125°C
- Package Options Include Shrink Small-Outline (DL) 300-mil Packages Using 25-mil Center-to-Center Pin Spacings and 380-mil Fine-Pitch Ceramic Flat (WD) Packages Using 25-mil Center-to-Center Pin Spacings

SN54ACT16373 . . . WD PACKAGE
74ACT16373 . . . DL PACKAGE
(TOP VIEW)

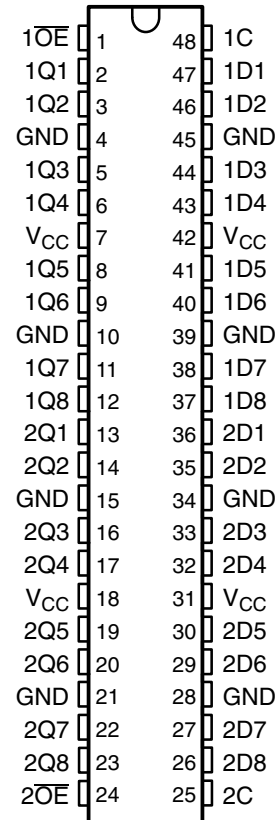

description

The SN54ACT16373 and 74ACT16373 are 16-bit D-type transparent latches with 3-state outputs designed specifically for driving highly capacitive or relatively low-impedance loads. They are particularly suitable for implementing buffer registers, I/O ports, bidirectional bus drivers, and working registers. These devices can be used as two 8-bit latches or one 16-bit latch. The Q outputs of the latches follow the data (D) inputs if enable C is taken high. When C is taken low, the Q outputs are latched at the levels set up at the D inputs.

A buffered output-enable (\overline{OE}) input can be used to place the outputs in either a normal logic state (high or low logic levels) or the high-impedance state. In the high-impedance state, the outputs neither load nor drive the bus lines significantly. The high-impedance state and the increased drive provide the capability to drive bus lines in a bus-organized system without need for interface or pullup components.

\overline{OE} does not affect the internal operations of the latches. Old data can be retained or new data can be entered while the outputs are in the high-impedance state.

The 74ACT16373 is packaged in TI's shrink small-outline package, which provides twice the I/O pin count and functionality of standard small-outline packages in the same printed-circuit-board area.

The SN54ACT16373 is characterized for operation over the full military temperature range of -55°C to 125°C. The 74ACT16373 is characterized for operation from -40°C to 85°C.



Please be aware that an important notice concerning availability, standard warranty, and use in critical applications of Texas Instruments semiconductor products and disclaimers thereto appears at the end of this data sheet.

EPIC and Widebus are trademarks of Texas Instruments Incorporated.

PRODUCTION DATA information is current as of publication date. Products conform to specifications per the terms of Texas Instruments standard warranty. Production processing does not necessarily include testing of all parameters.

 **TEXAS
INSTRUMENTS**

POST OFFICE BOX 655303 • DALLAS, TEXAS 75265

Copyright © 1996, Texas Instruments Incorporated

SN54ACT16373, 74ACT16373 16-BIT D-TYPE TRANSPARENT LATCHES WITH 3-STATE OUTPUTS

SCAS122C – MARCH 1990 – REVISED SEPTEMBER 1996

FUNCTION TABLE

INPUTS			OUTPUT
\overline{OE}	C	D	Q
L	H	H	H
L	H	L	L
L	L	X	Q_0
H	X	X	Z

logic symbol†

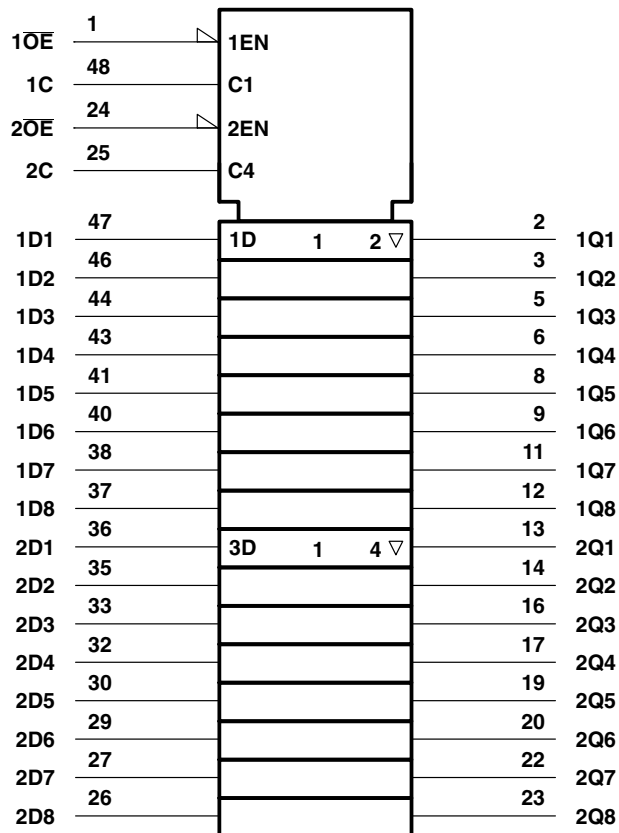

† This symbol is in accordance with ANSI/IEEE Std 91-1984 and IEC Publication 617-12.

SN54ACT16373, 74ACT16373 16-BIT D-TYPE TRANSPARENT LATCHES WITH 3-STATE OUTPUTS

SCAS122C – MARCH 1990 – REVISED SEPTEMBER 1996

logic diagram (positive logic)

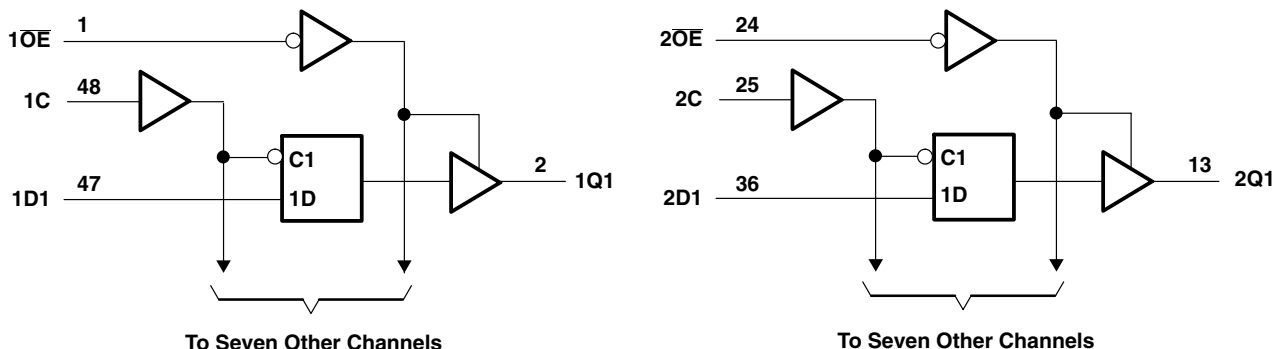

absolute maximum ratings over operating free-air temperature range (unless otherwise noted)[†]

Supply voltage range, V_{CC}	-0.5 V to 7 V
Input voltage range, V_I (see Note 1)	-0.5 V to $V_{CC} + 0.5$ V
Output voltage range, V_O (see Note 1)	-0.5 V to $V_{CC} + 0.5$ V
Input clamp current, I_{IK} ($V_I < 0$ or $V_I > V_{CC}$)	± 20 mA
Output clamp current, I_{OK} ($V_O < 0$ or $V_O > V_{CC}$)	± 50 mA
Continuous output current, I_O ($V_O = 0$ to V_{CC})	± 50 mA
Continuous current through V_{CC} or GND	± 400 mA
Maximum power dissipation at $T_A = 55^\circ\text{C}$ (in still air) (see Note 2): DL package	1.2 W
Storage temperature range, T_{stg}	-65°C to 150°C

[†] Stresses beyond those listed under "absolute maximum ratings" may cause permanent damage to the device. These are stress ratings only, and functional operation of the device at these or any other conditions beyond those indicated under "recommended operating conditions" is not implied. Exposure to absolute-maximum-rated conditions for extended periods may affect device reliability.

- NOTES: 1. The input and output voltage ratings may be exceeded if the input and output current ratings are observed.
2. The maximum package power dissipation is calculated using a junction temperature of 150°C and a board trace length of 750 mils.

recommended operating conditions (see Note 3)

	SN54ACT16373		74ACT16373		UNIT
	MIN	MAX	MIN	MAX	
V_{CC} Supply voltage (see Note 4)	4.5	5.5	4.5	5.5	V
V_{IH} High-level input voltage	2		2		V
V_{IL} Low-level input voltage		0.8		0.8	V
V_I Input voltage	0	V_{CC}	0	V_{CC}	V
V_O Output voltage	0	V_{CC}	0	V_{CC}	V
I_{OH} High-level output current		-24		-24	mA
I_{OL} Low-level output current		24		24	mA
$\Delta t/\Delta v$ Input transition rise or fall rate	0	10	0	10	ns/V
T_A Operating free-air temperature	-55	125	-40	85	$^\circ\text{C}$

- NOTES: 3. Unused inputs should be tied to V_{CC} through a pullup resistor of approximately 5 k Ω or greater to prevent them from floating.
4. All V_{CC} and GND pins must be connected to the proper voltage supply.

SN54ACT16373, 74ACT16373 16-BIT D-TYPE TRANSPARENT LATCHES WITH 3-STATE OUTPUTS

SCAS122C – MARCH 1990 – REVISED SEPTEMBER 1996

electrical characteristics over recommended operating free-air temperature range (unless otherwise noted)

PARAMETER	TEST CONDITIONS	V _{CC}	T _A = 25°C			SN54ACT16373		74ACT16373		UNIT
			MIN	TYP	MAX	MIN	MAX	MIN	MAX	
V _{OH}	I _{OH} = -50 μA	4.5 V	4.4			4.4		4.4	V	
		5.5 V	5.4			5.4		5.4		
	I _{OH} = -24 mA	4.5 V	3.94			3.7		3.8		
		5.5 V	4.94			4.7		4.8		
	I _{OH} = -50 mA [†]	5.5 V				3.85				
I _{OH} = -75 mA [†]	5.5 V						3.85			
V _{OL}	I _{OL} = 50 μA	4.5 V			0.1		0.1	0.1	V	
		5.5 V			0.1		0.1	0.1		
	I _{OL} = 24 mA	4.5 V			0.36		0.5	0.44		
		5.5 V			0.36		0.5	0.44		
	I _{OL} = 50 mA [†]	5.5 V					1.65			
I _{OL} = 75 mA [†]	5.5 V						1.65			
I _I	V _I = V _{CC} or GND	5.5 V			±0.1		±1	±1	μA	
I _{OZ}	V _O = V _{CC} or GND	5.5 V			±0.5		±10	±5	μA	
I _{CC}	V _I = V _{CC} or GND, I _O = 0	5.5 V			8		160	80	μA	
ΔI _{CC} [‡]	One input at 3.4 V, Other inputs at GND or V _{CC}	5.5 V			0.9		1	1	mA	
C _i	V _I = V _{CC} or GND	5 V			4.5				pF	
C _o	V _I = V _{CC} or GND	5 V			12				pF	

[†] Not more than one output should be tested at a time, and the duration of the test should not exceed 10 ms.

[‡] This is the increase in supply current for each input that is at one of the specified TTL voltage levels rather than 0 V to V_{CC}.

timing requirements over recommended ranges of supply voltage and operating free-air temperature (unless otherwise noted) (see Figure 1)

		T _A = 25°C		SN54ACT16373		74ACT16373		UNIT
		MIN	MAX	MIN	MAX	MIN	MAX	
t _w	Pulse duration, LE high	4		4		1		ns
t _{su}	Setup time, data before LE↓	1		1		1		ns
t _h	Hold time, data after LE↓	5		5		5		ns

switching characteristics over recommended ranges of supply voltage and operating free-air temperature (unless otherwise noted) (see Figure 1)

PARAMETER	FROM (INPUT)	TO (OUTPUT)	T _A = 25°C			SN54ACT16373		74ACT16373		UNIT
			MIN	TYP	MAX	MIN	MAX	MIN	MAX	
t _{PLH}	D	Q	3.8	7.9	9.4	3.8	11.8	3.8	11.1	ns
t _{PHL}			3.1	8.2	9.7	3.1	13	3.1	12.3	
t _{PLH}	LE	Q	4.6	9.3	10.8	4.6	13.7	4.6	12.8	ns
t _{PHL}			4.5	9.1	10.5	4.5	13	4.5	12.2	
t _{PZH}	OE	Q	3.1	8	9.5	3.1	13	3.1	12.1	ns
t _{PZL}			3.8	9.4	11.1	3.8	15.1	3.8	14.2	
t _{PHZ}	OE	Q	5.3	8.6	9.9	5.3	11	5.3	10.7	ns
t _{PLZ}			4.3	7.4	8.7	4.3	9.8	4.3	9.4	



SN54ACT16373, 74ACT16373 16-BIT D-TYPE TRANSPARENT LATCHES WITH 3-STATE OUTPUTS

SCAS122C – MARCH 1990 – REVISED SEPTEMBER 1996

operating characteristics, $V_{CC} = 5\text{ V}$, $T_A = 25^\circ\text{C}$

PARAMETER		TEST CONDITIONS	TYP	UNIT
C_{pd}	Power dissipation capacitance per latch	Outputs enabled	43	pF
		Outputs disabled	4.5	



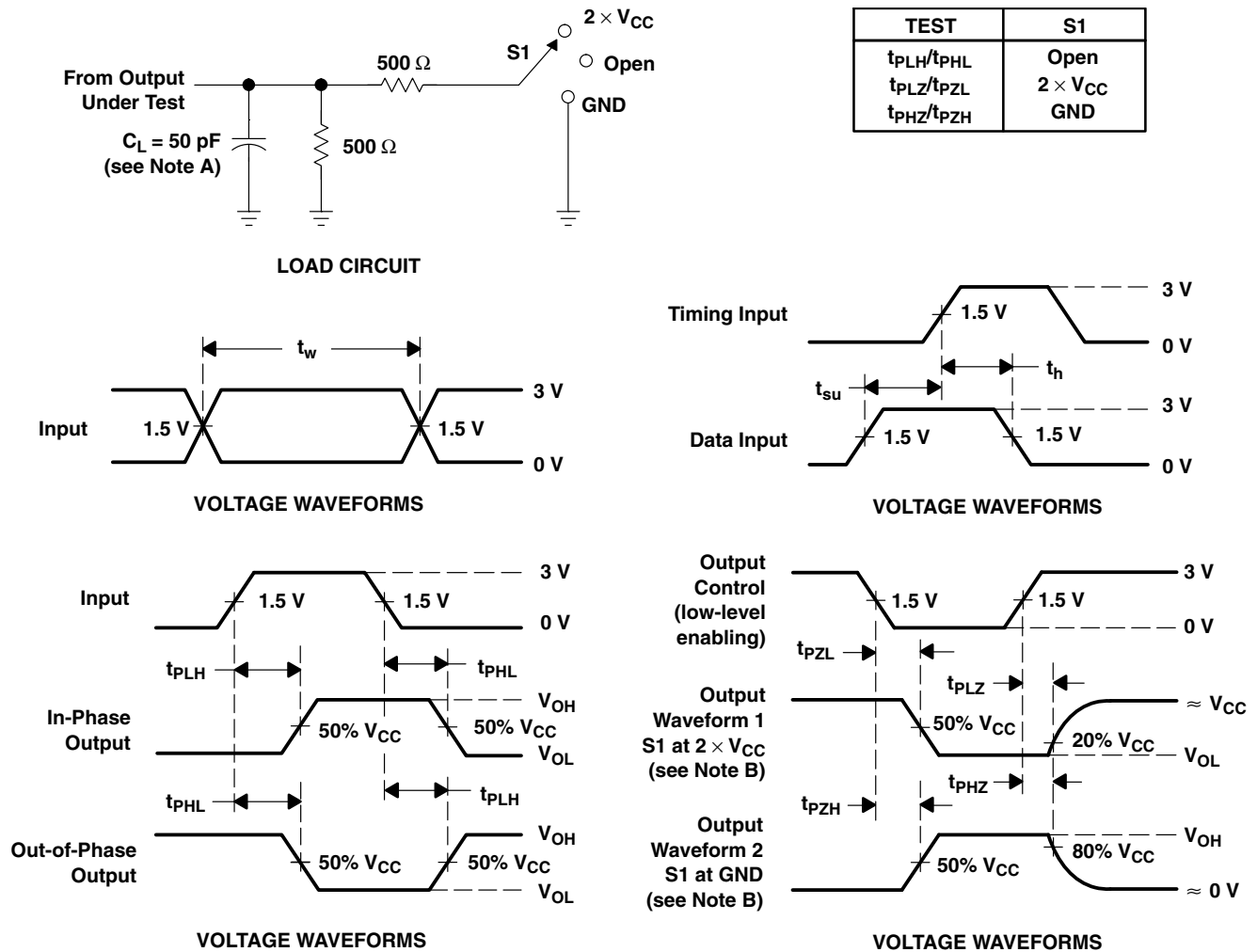



PARAMETER MEASUREMENT INFORMATION



- NOTES: A. C_L includes probe and jig capacitance.
 B. Waveform 1 is for an output with internal conditions such that the output is low except when disabled by the output control. Waveform 2 is for an output with internal conditions such that the output is high except when disabled by the output control.
 C. All input pulses are supplied by generators having the following characteristics: $PRR \leq 1\text{ MHz}$, $Z_O = 50\ \Omega$, $t_r = 3\text{ ns}$, $t_f = 3\text{ ns}$.
 D. The outputs are measured one at a time with one input transition per measurement.

Figure 1. Load Circuit and Voltage Waveforms

PACKAGING INFORMATION

Orderable Device	Status (1)	Package Type	Package Drawing	Pins	Package Qty	Eco Plan (2)	Lead/Ball Finish (6)	MSL Peak Temp (3)	Op Temp (°C)	Device Marking (4/5)	Samples
5962-9202401MXA	ACTIVE	CFP	WD	48	1	TBD	A42	N / A for Pkg Type	-55 to 125	5962-9202401MX A SNJ54ACT16373W D	
74ACT16373DL	ACTIVE	SSOP	DL	48	25	Green (RoHS & no Sb/Br)	CU NIPDAU	Level-1-260C-UNLIM	-40 to 85	ACT16373	
74ACT16373DLG4	ACTIVE	SSOP	DL	48	25	Green (RoHS & no Sb/Br)	CU NIPDAU	Level-1-260C-UNLIM	-40 to 85	ACT16373	
74ACT16373DLR	ACTIVE	SSOP	DL	48	1000	Green (RoHS & no Sb/Br)	CU NIPDAU	Level-1-260C-UNLIM	-40 to 85	ACT16373	
74ACT16373DLRG4	ACTIVE	SSOP	DL	48	1000	Green (RoHS & no Sb/Br)	CU NIPDAU	Level-1-260C-UNLIM	-40 to 85	ACT16373	
SNJ54ACT16373WD	ACTIVE	CFP	WD	48	1	TBD	A42	N / A for Pkg Type	-55 to 125	5962-9202401MX A SNJ54ACT16373W D	

(1) The marketing status values are defined as follows:

ACTIVE: Product device recommended for new designs.

LIFEBUY: TI has announced that the device will be discontinued, and a lifetime-buy period is in effect.

NRND: Not recommended for new designs. Device is in production to support existing customers, but TI does not recommend using this part in a new design.

PREVIEW: Device has been announced but is not in production. Samples may or may not be available.

OBSOLETE: TI has discontinued the production of the device.

(2) Eco Plan - The planned eco-friendly classification: Pb-Free (RoHS), Pb-Free (RoHS Exempt), or Green (RoHS & no Sb/Br) - please check <http://www.ti.com/productcontent> for the latest availability information and additional product content details.

TBD: The Pb-Free/Green conversion plan has not been defined.

Pb-Free (RoHS): TI's terms "Lead-Free" or "Pb-Free" mean semiconductor products that are compatible with the current RoHS requirements for all 6 substances, including the requirement that lead not exceed 0.1% by weight in homogeneous materials. Where designed to be soldered at high temperatures, TI Pb-Free products are suitable for use in specified lead-free processes.

Pb-Free (RoHS Exempt): This component has a RoHS exemption for either 1) lead-based flip-chip solder bumps used between the die and package, or 2) lead-based die adhesive used between the die and leadframe. The component is otherwise considered Pb-Free (RoHS compatible) as defined above.

Green (RoHS & no Sb/Br): TI defines "Green" to mean Pb-Free (RoHS compatible), and free of Bromine (Br) and Antimony (Sb) based flame retardants (Br or Sb do not exceed 0.1% by weight in homogeneous material)

(3) MSL, Peak Temp. - The Moisture Sensitivity Level rating according to the JEDEC industry standard classifications, and peak solder temperature.

(4) There may be additional marking, which relates to the logo, the lot trace code information, or the environmental category on the device.

⁽⁵⁾ Multiple Device Markings will be inside parentheses. Only one Device Marking contained in parentheses and separated by a "~" will appear on a device. If a line is indented then it is a continuation of the previous line and the two combined represent the entire Device Marking for that device.

⁽⁶⁾ Lead/Ball Finish - Orderable Devices may have multiple material finish options. Finish options are separated by a vertical ruled line. Lead/Ball Finish values may wrap to two lines if the finish value exceeds the maximum column width.

Important Information and Disclaimer:The information provided on this page represents TI's knowledge and belief as of the date that it is provided. TI bases its knowledge and belief on information provided by third parties, and makes no representation or warranty as to the accuracy of such information. Efforts are underway to better integrate information from third parties. TI has taken and continues to take reasonable steps to provide representative and accurate information but may not have conducted destructive testing or chemical analysis on incoming materials and chemicals. TI and TI suppliers consider certain information to be proprietary, and thus CAS numbers and other limited information may not be available for release.

In no event shall TI's liability arising out of such information exceed the total purchase price of the TI part(s) at issue in this document sold by TI to Customer on an annual basis.

TAPE AND REEL INFORMATION

REEL DIMENSIONS

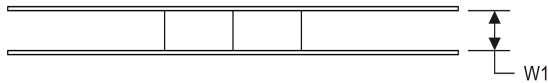
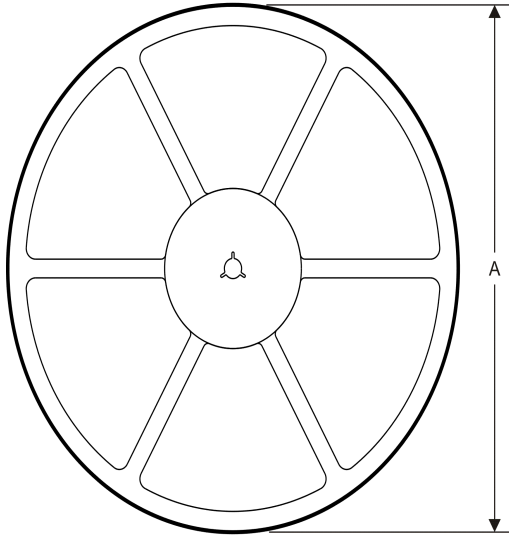

TAPE DIMENSIONS

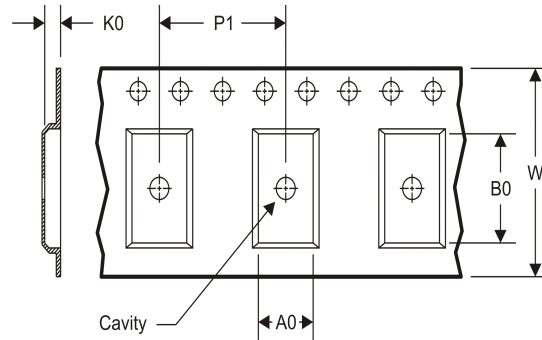

A0	Dimension designed to accommodate the component width
B0	Dimension designed to accommodate the component length
K0	Dimension designed to accommodate the component thickness
W	Overall width of the carrier tape
P1	Pitch between successive cavity centers

TAPE AND REEL INFORMATION

*All dimensions are nominal

Device	Package Type	Package Drawing	Pins	SPQ	Reel Diameter (mm)	Reel Width W1 (mm)	A0 (mm)	B0 (mm)	K0 (mm)	P1 (mm)	W (mm)	Pin1 Quadrant
74ACT16373DLR	SSOP	DL	48	1000	330.0	32.4	11.35	16.2	3.1	16.0	32.0	Q1

TAPE AND REEL BOX DIMENSIONS



*All dimensions are nominal

Device	Package Type	Package Drawing	Pins	SPQ	Length (mm)	Width (mm)	Height (mm)
74ACT16373DLR	SSOP	DL	48	1000	367.0	367.0	55.0

WD (R-GDFP-F**)

CERAMIC DUAL FLATPACK

48 LEADS SHOWN

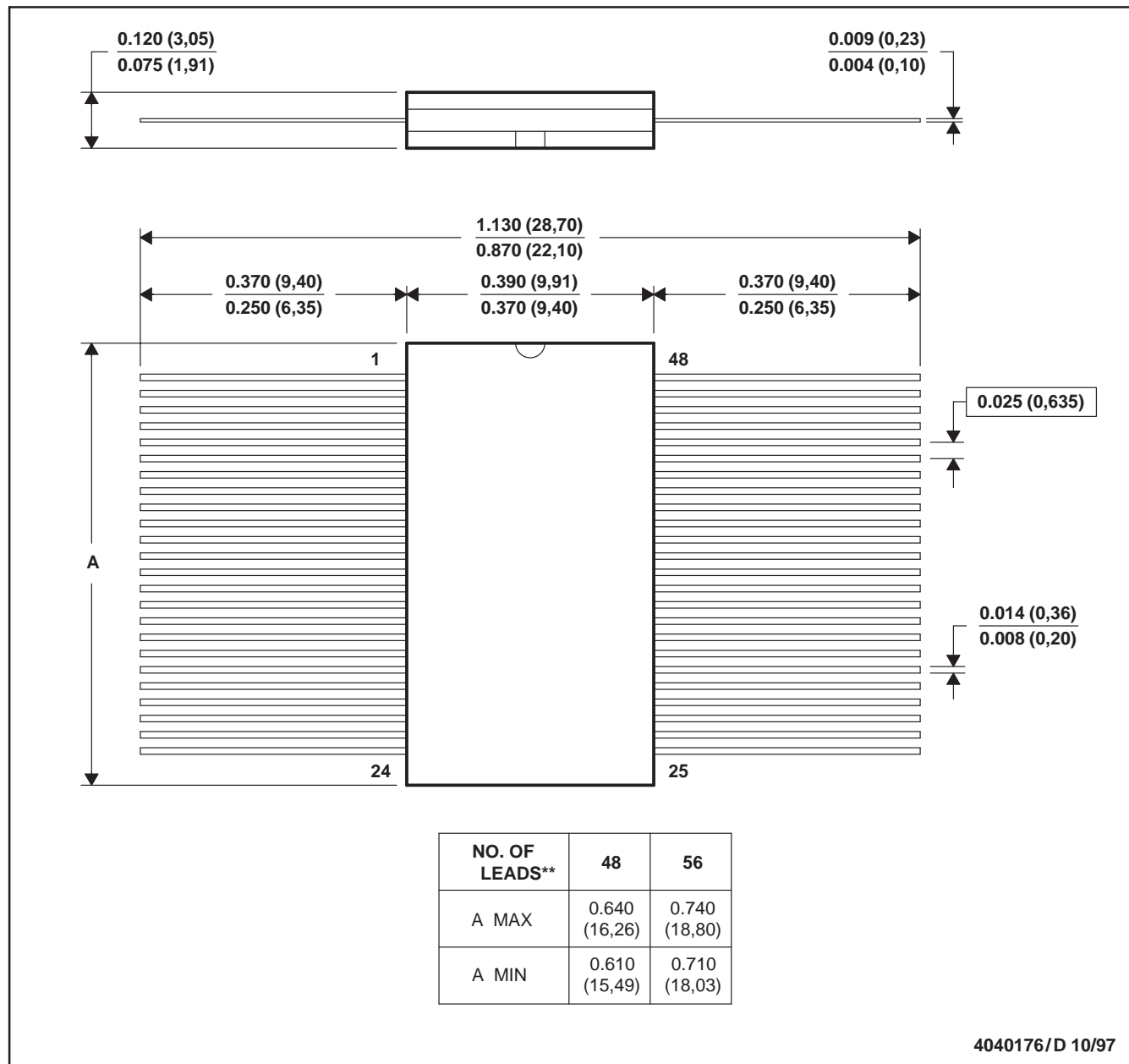

- NOTES: A. All linear dimensions are in inches (millimeters).
 B. This drawing is subject to change without notice.
 C. This package can be hermetically sealed with a ceramic lid using glass frit.
 D. Index point is provided on cap for terminal identification only
 E. Falls within MIL STD 1835: GDFP1-F48 and JEDEC MO-146AA
 GDFP1-F56 and JEDEC MO-146AB

IMPORTANT NOTICE

Texas Instruments Incorporated and its subsidiaries (TI) reserve the right to make corrections, enhancements, improvements and other changes to its semiconductor products and services per JESD46, latest issue, and to discontinue any product or service per JESD48, latest issue. Buyers should obtain the latest relevant information before placing orders and should verify that such information is current and complete. All semiconductor products (also referred to herein as "components") are sold subject to TI's terms and conditions of sale supplied at the time of order acknowledgment.

TI warrants performance of its components to the specifications applicable at the time of sale, in accordance with the warranty in TI's terms and conditions of sale of semiconductor products. Testing and other quality control techniques are used to the extent TI deems necessary to support this warranty. Except where mandated by applicable law, testing of all parameters of each component is not necessarily performed.

TI assumes no liability for applications assistance or the design of Buyers' products. Buyers are responsible for their products and applications using TI components. To minimize the risks associated with Buyers' products and applications, Buyers should provide adequate design and operating safeguards.

TI does not warrant or represent that any license, either express or implied, is granted under any patent right, copyright, mask work right, or other intellectual property right relating to any combination, machine, or process in which TI components or services are used. Information published by TI regarding third-party products or services does not constitute a license to use such products or services or a warranty or endorsement thereof. Use of such information may require a license from a third party under the patents or other intellectual property of the third party, or a license from TI under the patents or other intellectual property of TI.

Reproduction of significant portions of TI information in TI data books or data sheets is permissible only if reproduction is without alteration and is accompanied by all associated warranties, conditions, limitations, and notices. TI is not responsible or liable for such altered documentation. Information of third parties may be subject to additional restrictions.

Resale of TI components or services with statements different from or beyond the parameters stated by TI for that component or service voids all express and any implied warranties for the associated TI component or service and is an unfair and deceptive business practice. TI is not responsible or liable for any such statements.

Buyer acknowledges and agrees that it is solely responsible for compliance with all legal, regulatory and safety-related requirements concerning its products, and any use of TI components in its applications, notwithstanding any applications-related information or support that may be provided by TI. Buyer represents and agrees that it has all the necessary expertise to create and implement safeguards which anticipate dangerous consequences of failures, monitor failures and their consequences, lessen the likelihood of failures that might cause harm and take appropriate remedial actions. Buyer will fully indemnify TI and its representatives against any damages arising out of the use of any TI components in safety-critical applications.

In some cases, TI components may be promoted specifically to facilitate safety-related applications. With such components, TI's goal is to help enable customers to design and create their own end-product solutions that meet applicable functional safety standards and requirements. Nonetheless, such components are subject to these terms.

No TI components are authorized for use in FDA Class III (or similar life-critical medical equipment) unless authorized officers of the parties have executed a special agreement specifically governing such use.

Only those TI components which TI has specifically designated as military grade or "enhanced plastic" are designed and intended for use in military/aerospace applications or environments. Buyer acknowledges and agrees that any military or aerospace use of TI components which have **not** been so designated is solely at the Buyer's risk, and that Buyer is solely responsible for compliance with all legal and regulatory requirements in connection with such use.

TI has specifically designated certain components as meeting ISO/TS16949 requirements, mainly for automotive use. In any case of use of non-designated products, TI will not be responsible for any failure to meet ISO/TS16949.

Products

Audio	www.ti.com/audio
Amplifiers	amplifier.ti.com
Data Converters	dataconverter.ti.com
DLP® Products	www.dlp.com
DSP	dsp.ti.com
Clocks and Timers	www.ti.com/clocks
Interface	interface.ti.com
Logic	logic.ti.com
Power Mgmt	power.ti.com
Microcontrollers	microcontroller.ti.com
RFID	www.ti-rfid.com
OMAP Applications Processors	www.ti.com/omap
Wireless Connectivity	www.ti.com/wirelessconnectivity

Applications

Automotive and Transportation	www.ti.com/automotive
Communications and Telecom	www.ti.com/communications
Computers and Peripherals	www.ti.com/computers
Consumer Electronics	www.ti.com/consumer-apps
Energy and Lighting	www.ti.com/energy
Industrial	www.ti.com/industrial
Medical	www.ti.com/medical
Security	www.ti.com/security
Space, Avionics and Defense	www.ti.com/space-avionics-defense
Video and Imaging	www.ti.com/video

TI E2E Community

e2e.ti.com