



16-Bit, 250kSPS, 4-Channel, Parallel Output ANALOG-TO-DIGITAL CONVERTER

FEATURES

- True Bipolar Input
- Input Signal Range: $\pm 2.5V$
- 4-Channel Input Multiplexer
- Up to 250kSPS Sampling Rate
- Selectable 8-Bit or 16-Bit Parallel Interface
- 16-Bit Ensured No Missing Codes
- Offset: 1mV max
- Low Power: 200mW
- TQFP-48 Package
- Operating Temperature Range: $-40^{\circ}C$ to $+85^{\circ}C$

DESCRIPTION

The ADS8342 is a 4-channel, 16-bit analog-to-digital converter (ADC). It contains a 16-bit successive approximation register (SAR), a capacitor-based ADC with an inherent sample-and-hold circuit, an interface for microprocessor use, and parallel 3-state output drivers. The ADS8342 is specified at a 250kHz sampling rate while dissipating only 200mW of power using a $\pm 5V$ power supply.

The ADS8342 is available in a TQFP-48 package and is ensured over the $-40^{\circ}C$ to $+85^{\circ}C$ temperature range.

APPLICATIONS

- Data Acquisition
- Test and Measurement
- Industrial Process Control
- Medical Instruments
- Laboratory Equipment

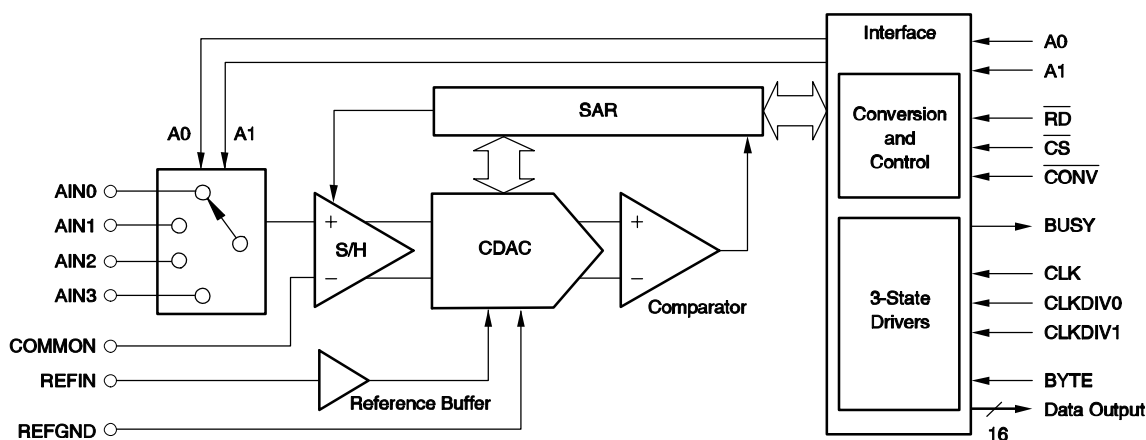

Please be aware that an important notice concerning availability, standard warranty, and use in critical applications of Texas Instruments semiconductor products and disclaimers thereto appears at the end of this data sheet.



This integrated circuit can be damaged by ESD. Texas Instruments recommends that all integrated circuits be handled with appropriate precautions. Failure to observe proper handling and installation procedures can cause damage.

ESD damage can range from subtle performance degradation to complete device failure. Precision integrated circuits may be more susceptible to damage because very small parametric changes could cause the device not to meet its published specifications.

ORDERING INFORMATION

PRODUCT	MAXIMUM INTEGRAL LINEARITY ERROR (LSB)	NO MISSING CODES (Bits)	PACKAGE-LEAD	PACKAGE DESIGNATOR(1)	SPECIFIED TEMPERATURE RANGE	ORDERING NUMBER	TRANSPORT MEDIA, QUANTITY
ADS8342	±6	15	TQFP-48	PFB	-40°C to +85°C	ADS8342IPFBT	Tape and Reel, 250
						ADS8342IPFBR	Tape and Reel, 2000
ADS8342	±4	16	TQFP-48	PFB	-40°C to +85°C	ADS8342IBPFBT	Tape and Reel, 250
						ADS8342IBPFBR	Tape and Reel, 2000

(1) For the most current specification and package information, refer to our web site at www.ti.com.

ABSOLUTE MAXIMUM RATINGS

over operating free-air temperature range unless otherwise noted(1)

	ADS8342I	UNIT
Supply voltage, +AV _{DD} to AGND and +DV _{DD} to DGND	-0.3 to 6	V
Supply voltage, -AV _{DD} to AGND and -DV _{DD} to DGND	-6 to 0.3	V
Supply voltage, BV _{DD} to BGND	-0.3 to 6	V
Analog input voltage to AGND	-AV _{DD} - 0.3 to +AV _{DD} + 0.3	V
Reference voltage, REF _{IN} to AGND	-0.3 to +AV _{DD} + 0.3	V
Common voltage to AGND	-0.3 to +0.3	V
Digital input voltage to BGND	BGND - 0.3 to BV _{DD} + 0.3	V
Ground voltage differences, AGND to REFGND or BGND or DGND	-0.3 to 0.3	V
Voltage differences, BV _{DD} or +DV _{DD} to AGND	-0.3 to 6	V
Voltage differences, +DV _{DD} to +AV _{DD} and -DV _{DD} to -AV _{DD}	-0.3 to 0.3	V
Voltage differences, BV _{DD} to DV _{DD}	-(+DV _{DD}) to 0.3	V
Input current to any pin except supply	-20 to 20	mA
Power dissipation	see Package Dissipation Ratings table	
Operating virtual junction temperature range, T _J	-40 to +150	°C
Operating free-air temperature range, T _A	-40 to +85	°C
Storage temperature range, T _{STG}	-65 to +150	°C
Lead temperature 1.6mm (1/16 inch) from case for 10 seconds	+300	°C

(1) Stresses above these ratings may cause permanent damage. Exposure to absolute maximum conditions for extended periods may degrade device reliability. These are stress ratings only, and functional operation of the device at these or any other conditions beyond those specified is not implied.

PACKAGE DISSIPATION RATINGS

BOARD	PACKAGE	$R_{\theta JC}$ (°C/W)	$R_{\theta JA}$ (°C/W)	DERATING FACTOR ABOVE $T_A \leq +25^\circ\text{C}$ (mW/°C)	$T_A \leq +25^\circ\text{C}$ POWER RATING (mW)	$T_A \leq +70^\circ\text{C}$ POWER RATING (mW)	$T_A = +85^\circ\text{C}$ POWER RATING (mW)
Low K	PFB	19.6	97.5	10.256	1282	820	666
High K	PFB	19.6	63.7	15.698	1962	1255	1020

- (1) The JEDEC Low K(1s) board design used to derive this data was a 3 inch x 3 inch, 2-layer board with 2-ounce copper traces on top of the board.
 (2) The JEDEC High K(2s2p) board design used to derive this data was a 3 inch x 3 inch, multilayer board with 1-ounce internal power and ground planes and 2-ounce copper traces on the top and bottom of the board.

RECOMMENDED OPERATING CONDITIONS

	MIN	NOM	MAX	UNIT
Supply voltage, +AV _{DD} to AGND	4.75	5	5.25	V
Supply voltage, -AV _{DD} to AGND	-5.25	-5	-4.75	V
Supply voltage, BV _{DD} to BGND	Low-voltage levels		3.6	V
	5V logic levels		+DV _{DD}	V
Supply voltage, +DV _{DD} to DGND	4.75	5	5.25	V
Supply voltage, -DV _{DD} to DGND	-5.25	-5	-4.75	V
Reference input voltage	2.0	2.5	2.55	V
Analog input voltage	-REF _{IN}		+REF _{IN}	V
Common voltage	-0.3	0	+0.3	V
Ground differences, AGND to REFGND or BGND or DGND	-0.01	0	0.01	V
Voltage differences, +DV _{DD} to +AV _{DD} and -DV _{DD} to -AV _{DD}	-0.01	0	0.01	V

EQUIVALENT INPUT CIRCUIT

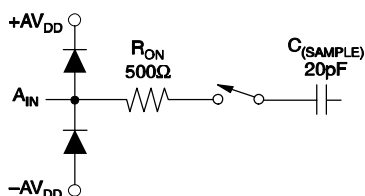

Equivalent Analog Input Circuit

Diode Turn-on Voltage: 0.35V

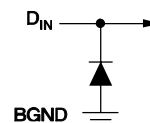

Equivalent Digital Input Circuit

ELECTRICAL CHARACTERISTICS

Over recommended operating free-air temperature range at -40°C to $+85^{\circ}\text{C}$, $\pm\text{AV}_{\text{DD}} = \pm\text{DV}_{\text{DD}} = \pm 5\text{V}$, $\text{BV}_{\text{DD}} = +5\text{V}$, $\text{V}_{\text{REF}} = +2.5\text{V}$, $f_{\text{CLK}} = 5\text{MHz}$, and $f_{\text{SAMPLE}} = 250\text{kSPS}$, unless otherwise noted.

PARAMETER	TEST CONDITIONS	ADS8342I			ADS8342IB			UNIT
		MIN	TYP(1)	MAX	MIN	TYP(1)	MAX	
Analog Input								
Full-scale range (FSR)	AIN to Common	$-V_{\text{REF}}$		$+V_{\text{REF}}$	*		*	V
Input MUX on-resistance	Common = AGND		500			*		Ω
Input capacitance	Common = AGND		20			*		pF
Input leakage current	Common = AGND		± 0.3			*		μA
Full power bandwidth	FS sinewave, -3dB		16			*		MHz
Voltage Accuracy								
Resolution			16			*		Bits
No missing code (NMC)			15			16		Bits
Integral linearity error (INL)		-6	± 3	$+6$	-4	± 2	$+4$	LSB
Differential nonlinearity (DNL)		-2	± 1	$+2$	-1	± 0.6	$+1.5$	LSB
Bipolar zero (offset) error (V_{OS})	AIN = Common = 0V	-2		$+2$	-1		$+1$	mV
Bipolar zero (offset) error drift (TCV_{OS})	AIN = Common = 0V		1			*		$\text{ppm}/^{\circ}\text{C}$
Bipolar zero (offset) error match	AIN = Common = 0V		0.150	1		*	*	mV
Positive gain error (PGERR)	AIN = V_{REF} , Common = 0V	-0.25		$+0.25$	*		*	% FSR
Positive gain error drift (TCPGERR)	AIN = V_{REF} , Common = 0V		1.5			*		$\text{ppm}/^{\circ}\text{C}$
Positive gain error match	AIN = V_{REF} , Common = 0V		0.003	0.01		*	*	% FSR
Negative gain error (NGERR)	AIN = $-V_{\text{REF}}$, Common = 0V	-0.25		$+0.25$	*		*	% FSR
Negative gain error drift (TCNGERR)	AIN = $-V_{\text{REF}}$, Common = 0V		1.5			*		$\text{ppm}/^{\circ}\text{C}$
Negative gain error match	AIN = $-V_{\text{REF}}$, Common = 0V		0.003	0.01		*	*	% FSR
Sampling Dynamics								
Conversion time (t_{CONV})	$500\text{kHz} \leq f_{\text{CLK}} \leq 5\text{MHz}$		3.4	34		*	*	μs
Acquisition time (t_{ACQ})	$f_{\text{CLK}} = 5\text{MHz}$		0.6			*	*	μs
Throughput rate				250		*		kHz
Multiplexer settling time			150			*		ns
Aperture delay			8			*		ns
Aperture jitter			50			*		ps
AC Accuracy								
Total harmonic distortion (THD)	$V_{\text{IN}} = \pm 2.5\text{Vp-p}$ at 10kHz		-89			*		dB
Spurious-free dynamic range (SFDR)	$V_{\text{IN}} = \pm 2.5\text{Vp-p}$ at 10kHz		92			*		dB
Signal-to-noise ratio (SNR)	$V_{\text{IN}} = \pm 2.5\text{Vp-p}$ at 10kHz		86			*		dB
Signal-to-noise + distortion (SINAD)	$V_{\text{IN}} = \pm 2.5\text{Vp-p}$ at 10kHz		84.6			*		dB
Channel-to-channel isolation ⁽²⁾	$V_{\text{IN}} = \pm 2.5\text{Vp-p}$ at 50kHz		95			*		dB
Effective number of bits (ENOB)			14			*		Bits

* Indicates the same specifications as the ADS8342I.

(1) All typical values are at $T_{\text{A}} = +25^{\circ}\text{C}$.

(2) Ensured by design.

(3) Applies for 5.0V nominal supply: $\text{BV}_{\text{DD}}(\text{min}) = 4.5\text{V}$ and $\text{BV}_{\text{DD}}(\text{max}) = 5.5\text{V}$.

(4) Applies for 3.0V nominal supply: $\text{BV}_{\text{DD}}(\text{min}) = 2.7\text{V}$ and $\text{BV}_{\text{DD}}(\text{max}) = 3.6\text{V}$.

ELECTRICAL CHARACTERISTICS (continued)

 Over recommended operating free-air temperature range at -40°C to $+85^{\circ}\text{C}$, $\pm AV_{DD} = \pm DV_{DD} = \pm 5\text{V}$, $BV_{DD} = +5\text{V}$, $V_{REF} = +2.5\text{V}$, $f_{CLK} = 5\text{MHz}$, and $f_{SAMPLE} = 250\text{kSPS}$, unless otherwise noted.

PARAMETER	TEST CONDITIONS	ADS8342I			ADS8342IB			UNIT
		MIN	TYP(1)	MAX	MIN	TYP(1)	MAX	
Voltage Reference Input								
Reference voltage		2.0	2.5	2.55	*	*	*	V
Reference input resistance			100			*		$M\Omega$
Reference input capacitance			5			*		pF
Reference input current			25			*		nA
5V Digital Inputs(3)								
Logic family		CMOS						
High-level input voltage (V_{IH})		$0.7 \times BV_{DD}$		$BV_{DD} + 0.3$				V
Low-level input voltage (V_{IL})		-0.3	$0.3 \times BV_{DD}$					V
Input leakage current (I_{IN})	$V_I = BV_{DD}$ or GND		± 50					nA
Input capacitance (C_I)			5					pF
5V Digital Outputs(3)								
Logic family		CMOS						
High-level output voltage (V_{OH})	$I_{OH} = -100\mu\text{A}$	4.4						V
Low-level output voltage (V_{OL})	$I_{OL} = +100\mu\text{A}$		0.5					V
High-impedance-state output current (I_{OZ})	$\overline{CS} = BV_{DD}$, $V_O = BV_{DD}$ or GND		± 50					nA
Output capacitance (C_O)			5					pF
Load capacitance (C_L)			20					pF
Data format		Binary Two's Complement						
3V Digital Inputs(4)								
Logic family		LVCMOS						
High-level input voltage (V_{IH})	$BV_{DD} = 3.6\text{V}$	2		$BV_{DD} + 0.3$				V
Low-level input voltage (V_{IL})	$BV_{DD} = 2.7\text{V}$	-0.3	0.8					V
Input leakage current (I_{IN})	$V_I = BV_{DD}$ or GND		± 50					nA
Input capacitance (C_I)			5					pF
3V Digital Outputs(4)								
Logic family		LVCMOS						
High-level output voltage (V_{OH})	$BV_{DD} = 2.7\text{V}$, $I_{OH} = -100\mu\text{A}$	$BV_{DD} - 0.3$						V
Low-level output voltage (V_{OL})	$BV_{DD} = 2.7\text{V}$, $I_{OL} = +100\mu\text{A}$		0.2					V
High-impedance-state output current (I_{OZ})	$\overline{CS} = BV_{DD}$, $V_O = BV_{DD}$ or GND		± 50					nA
Output capacitance (C_O)			5					pF
Load capacitance (C_L)			20					pF
Data format		Binary Two's Complement						

* Indicates the same specifications as the ADS8342I.

 (1) All typical values are at $T_A = +25^{\circ}\text{C}$.

(2) Ensured by design.

 (3) Applies for 5.0V nominal supply: BV_{DD} (min) = 4.5V and BV_{DD} (max) = 5.5V.

 (4) Applies for 3.0V nominal supply: BV_{DD} (min) = 2.7V and BV_{DD} (max) = 3.6V.

ELECTRICAL CHARACTERISTICS (continued)

Over recommended operating free-air temperature range at -40°C to $+85^{\circ}\text{C}$, $\pm\text{AV}_{\text{DD}} = \pm\text{DV}_{\text{DD}} = \pm 5\text{V}$, $\text{BV}_{\text{DD}} = +5\text{V}$, $\text{V}_{\text{REF}} = +2.5\text{V}$, $f_{\text{CLK}} = 5\text{MHz}$, and $f_{\text{SAMPLE}} = 250\text{kSPS}$, unless otherwise noted.

PARAMETER	TEST CONDITIONS	ADS8342I			ADS8342IB			UNIT
		MIN	TYP(1)	MAX	MIN	TYP(1)	MAX	
Power-Supply Requirements								
Negative analog power supply ($-\text{AV}_{\text{DD}}$)		-5.25		-4.75	*	*		V
Positive analog power supply ($+\text{AV}_{\text{DD}}$)		4.75		5.25	*	*		V
Negative digital power supply ($-\text{DV}_{\text{DD}}$)		-5.25		-4.75	*	*		V
Positive digital power supply ($+\text{DV}_{\text{DD}}$)		4.75		5.25	*	*		V
I/O buffer power supply (BV_{DD})	Low-voltage levels	2.7		3.6	*	*		V
	5V logic levels	4.5		$+\text{DV}_{\text{DD}}$	*	*		V
Negative analog operating supply current ($-\text{AI}_{\text{DD}}$)			11.5	13.8	*	*		mA
Positive analog operating supply current ($+\text{AI}_{\text{DD}}$)			14	16.8	*	*		mA
Negative digital operating supply current ($-\text{DI}_{\text{DD}}$)			8.3	9.9	*	*		mA
Positive digital operating supply current ($+\text{DI}_{\text{DD}}$)			7.1	8.5	*	*		mA
I/O buffer operating supply current (BI_{DD})	$\text{BV}_{\text{DD}} = 3\text{V}$		0.65	0.81	*	*		mA
	$\text{BV}_{\text{DD}} = 5\text{V}$		1	1.25	*	*		mA
Power Dissipation	$\text{BV}_{\text{DD}} = 3\text{V}$		208	250	*	*		mW

* Indicates the same specifications as the ADS8342I.

(1) All typical values are at $T_A = +25^{\circ}\text{C}$.

(2) Ensured by design.

(3) Applies for 5.0V nominal supply: BV_{DD} (min) = 4.5V and BV_{DD} (max) = 5.5V.

(4) Applies for 3.0V nominal supply: BV_{DD} (min) = 2.7V and BV_{DD} (max) = 3.6V.

APPLICATION BLOCK DIAGRAM

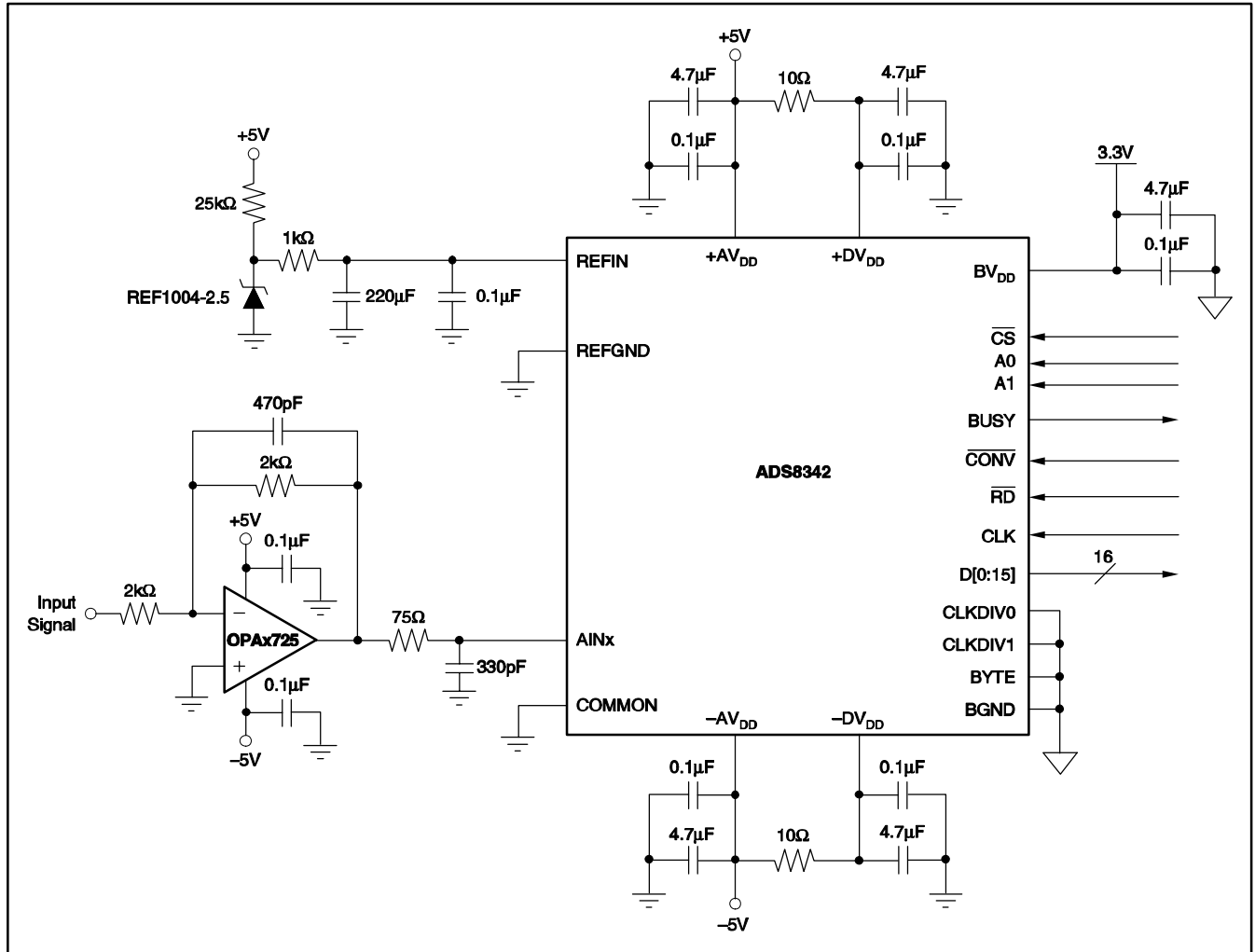
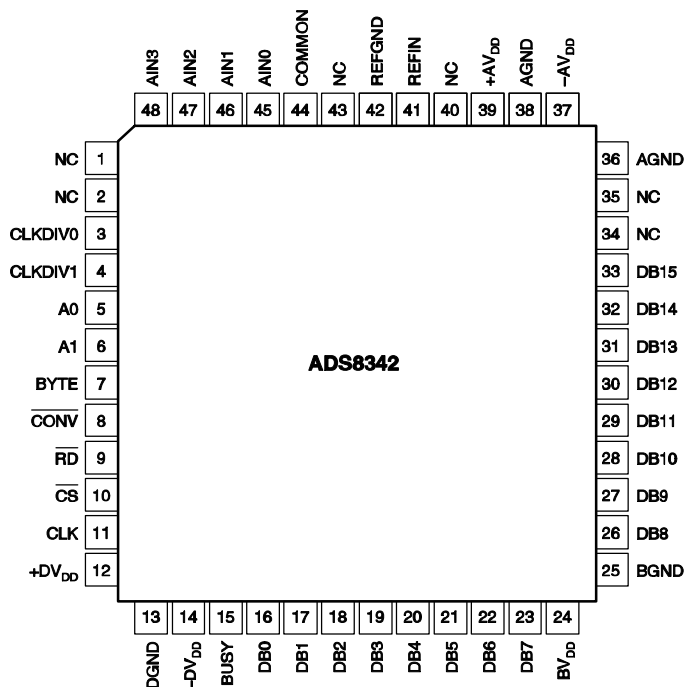

Figure 1. ADS8342 Typical Connection Diagram

**TQFP PACKAGE
(TOP VIEW)**



PIN ASSIGNMENTS—NUMERICAL LISTING

PIN NO.	PIN NAME	PIN NO.	PIN NAME
1	NC(1)	25	BGND
2	NC(1)	26	DB8
3	CLKDIV0	27	DB9
4	CLKDIV1	28	DB10
5	A0	29	DB11
6	A1	30	DB12
7	BYTE	31	DB13
8	CONV	32	DB14
9	RD	33	DB15 (MSB)
10	CS	34	NC(1)
11	CLK	35	NC(1)
12	+DVDD	36	AGND
13	DGND	37	-AVDD
14	-DVDD	38	AGND
15	BUSY	39	+AVDD
16	DB0 (LSB)	40	NC(1)
17	DB1	41	REFIN
18	DB2	42	REFGND
19	DB3	43	NC(1)
20	DB4	44	COMMON
21	DB5	45	AIN0
22	DB6	46	AIN1
23	DB7	47	AIN2
24	BVDD	48	AIN3

(1) NC = no connection. These pins should be left unconnected.

Terminal Functions

TERMINAL NAME	NO.	TYPE ⁽¹⁾	DESCRIPTION
Analog Input Signals			
AIN0	45	AI	Analog input 0
AIN1	46	AI	Analog input 1
AIN2	47	AI	Analog input 2
AIN3	48	AI	Analog input 3
COMMON	44	AI	Analog input common signal
REFIN	41	AI	Reference voltage input pin for external reference voltage. Decouple to reference ground with a 0.1 μ F ceramic capacitor.
REFGND	42	AI	Reference ground. Connected to the ground of the external reference voltage.
Digital Interface Signals			
A(x)	5, 6	DI	Address decode input, select analog input.
DB(x)	16–23, 26–33	DO	Output 3-state data bus. DB15 (MSB) to DB0 (LSB). Data lines are 3-state during conversion. \overline{RD} should be asserted only when the part is not converting.
\overline{CS}	10	DI	Active low chip select signal
\overline{RD}	9	DI	Active low read signal
CLK	11	DI	System clock
CLKDIV(x)	3, 4	DI	Select clock divider ratio. Internally divides external clock (pin 11) by 1, 2, 4, or 8.
\overline{CONV}	8	DI	Convert start. When \overline{CONV} switches from high to low, the device switches from sample mode to hold mode, independent of the external clock status. The address for the next conversion will be latched on low-to-high transition.
BUSY	15	DO	BUSY goes high during a conversion and returns low at the end when data is available for reading.
BYTE	7	DI	Active high bus width is 8 bits. When BYTE is low, the bus width is 16 bits.
Power Supply			
+AVDD	39	P	Positive analog power supply, +5V _{DC} . Decouple to analog ground with a 0.1 μ F ceramic capacitor and a 4.7 μ F tantalum capacitor. Referenced to the same power supply as +DVDD (pin 12).
-AVDD	37	P	Negative analog power supply -5V _{DC} . Decouple to analog ground with a 0.1 μ F ceramic capacitor and a 4.7 μ F tantalum capacitor. Referenced to the same power supply as -DVDD (pin 14).
BVDD	24	P	Digital I/O power supply in the range 2.7V to DVDD. Decouple to digital I/O ground with a 0.1 μ F ceramic capacitor and a 4.7 μ F tantalum capacitor.
+DVDD	12	P	Positive digital power supply +5V _{DC} . Decouple to digital ground with a 0.1 μ F ceramic capacitor and a 4.7 μ F tantalum capacitor. Referenced to the same power supply as +AVDD (pin 39).
-DVDD	14	P	Negative digital power supply -5V _{DC} . Decouple to digital ground with a 0.1 μ F ceramic capacitor and a 4.7 μ F tantalum capacitor. Referenced to the same power supply as -AVDD (pin 37).
AGND	36, 38	P	Analog ground. Connected directly to digital ground (pin 13) and digital I/O ground (pin 25).
BGND	25	P	Digital I/O ground. Connected directly to analog ground (pins 36 and 38) and digital ground (pin 13).
DGND	13	P	Digital ground. Connected directly to analog ground (pins 36 and 38) and digital I/O ground (pin 25).

(1) AI is analog input, AO is analog output, DI is digital input, DO is digital output, and P is power-supply connection.

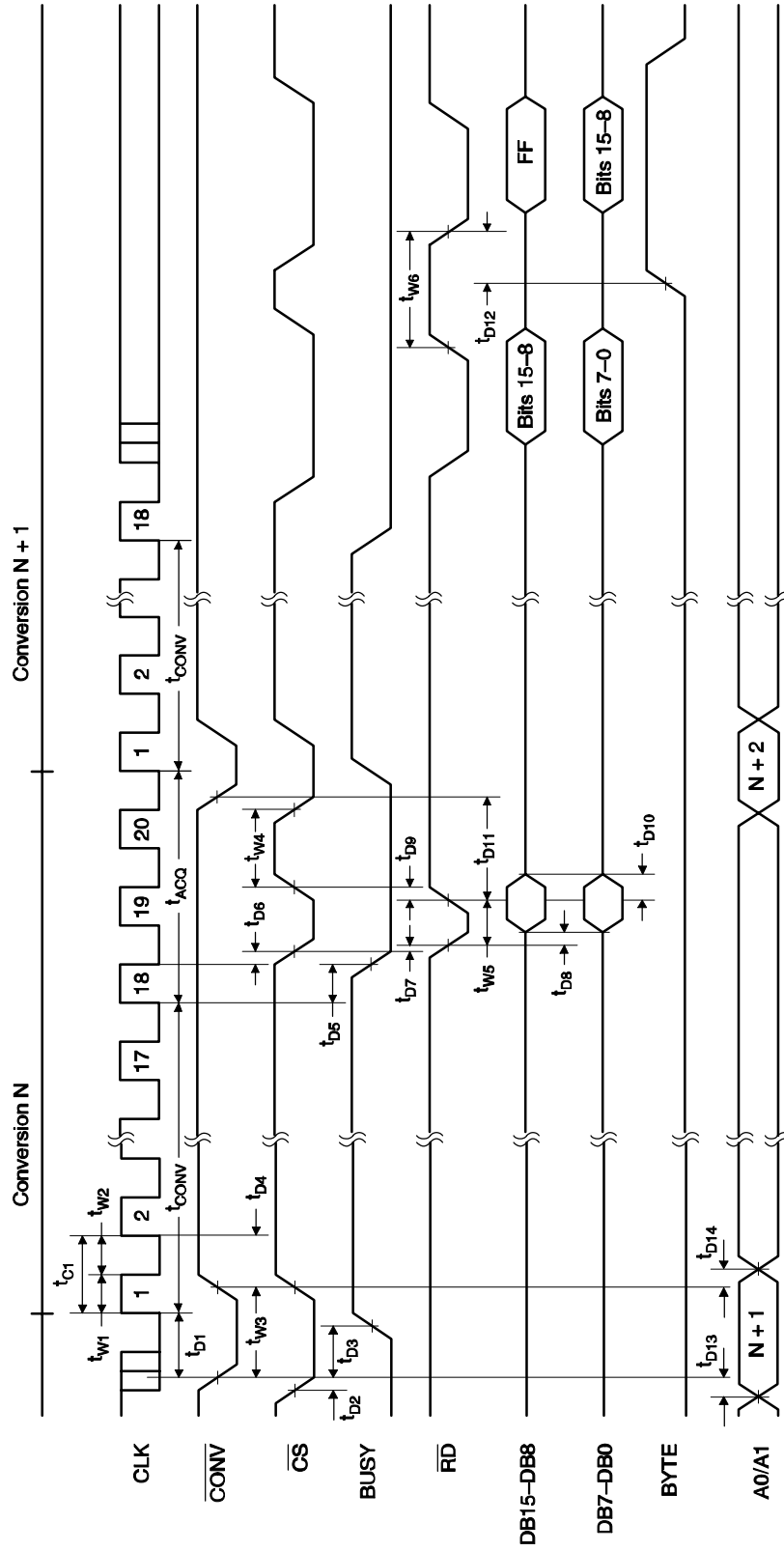

Figure 2. Timing Diagram

TIMING REQUIREMENTS(1)(2)

 Over recommended operating free-air temperature range at -40°C to $+85^{\circ}\text{C}$, and $\text{BV}_{\text{DD}} = +5\text{V}$, unless otherwise noted.

PARAMETER	SYMBOL	ADS8342I		ADS8342IB		UNIT
		MIN	MAX	MIN	MAX	
Conversion time	t_{CONV}	17		*		t_{C1}
Acquisition time	t_{ACQ}	3		*		t_{C1}
CLK period	t_{C1}	0.2	2	*	*	μs
CLK high time (for 5MHz clock frequency)	t_{W1}	25		*		ns
CLK low time (for 5MHz clock frequency)	t_{W2}	40		*		ns
$\overline{\text{CONV}}$ low to CLK high	t_{D1}	40		*		ns
$\overline{\text{CONV}}$ low time	t_{W3}	40		*		ns
$\overline{\text{CS}}$ low to $\overline{\text{CONV}}$ low	t_{D2}	0		*		ns
$\overline{\text{CONV}}$ low to BUSY high	t_{D3}		70		*	ns
$\overline{\text{CONV}}$ and $\overline{\text{CS}}$ high to 2nd CLK high ⁽³⁾	t_{D4}	80		*		ns
18 CLK high to BUSY low	t_{D5}		60		*	ns
18 CLK low to $\overline{\text{CS}}$ low	t_{D6}	0		*		ns
$\overline{\text{CS}}$ low to $\overline{\text{RD}}$ low	t_{D7}	0		*		ns
$\overline{\text{CS}}$ high time	t_{W4}		40		*	ns
$\overline{\text{RD}}$ low time	t_{W5}	40		*		ns
$\overline{\text{RD}}$ low to data valid	t_{D8}		25		*	ns
$\overline{\text{RD}}$ high to $\overline{\text{CS}}$ high	t_{D9}	0		*		ns
Data hold from $\overline{\text{RD}}$ high	t_{D10}	5		*		ns
$\overline{\text{RD}}$ high to $\overline{\text{CONV}}$ low	t_{D11}	1.5		*		t_{C1}
$\overline{\text{RD}}$ high time	t_{W6}	40		*		ns
BYTE change to $\overline{\text{RD}}$ low ⁽⁴⁾	t_{D12}	20		*		ns
A0 and A1 to $\overline{\text{CONV}}$ low	t_{D13}	40		*		ns
A0 and A1 hold to $\overline{\text{CONV}}$ high	t_{D14}	10		*		ns

* Indicates the same specifications as the ADS8342I.

 (1) All input signals are specified with rise and fall times of 5ns, $t_{\text{R}} = t_{\text{F}} = 5\text{ns}$ (10% to 90% of BV_{DD}), and timed from a voltage level of $(V_{\text{IL}} + V_{\text{IH}})/2$.

(2) See timing diagram in Figure 2.

 (3) $\overline{\text{CS}}$ can stay low during conversion. If it is not held low, then $\overline{\text{CS}}$ high to 2nd $\overline{\text{CS}}$ high must be $> 80\text{ns}$ (t_{D4})

 (4) $\overline{\text{RD}}$ is asynchronous. When BYTE is 0, bits 15 through 0 appear at DB15–DB0. When BYTE is 1, bits 15 through 8 appear on DB7–DB0. $\overline{\text{RD}}$ may remain low between changes in BYTE.

TYPICAL CHARACTERISTICS

At $T_A = +25^\circ\text{C}$, $+AV_{DD} = +DV_{DD} = +5\text{V}$, $BV_{DD} = 5\text{V}$, $V_{REF} = +2.5\text{V}$, $f_{CLK} = 5\text{MHz}$, and $f_{SAMPLE} = 250\text{kHz}$, unless otherwise noted.

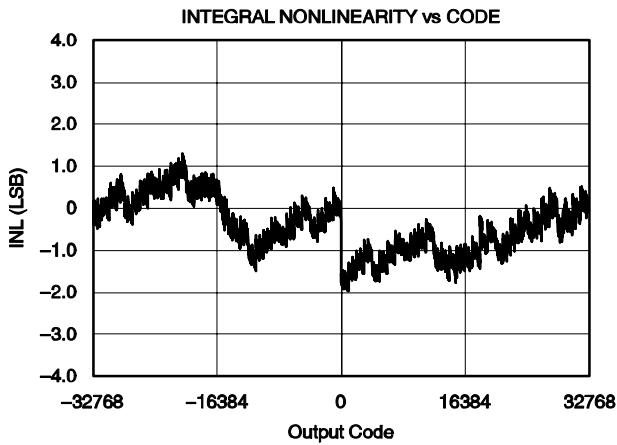

Figure 3

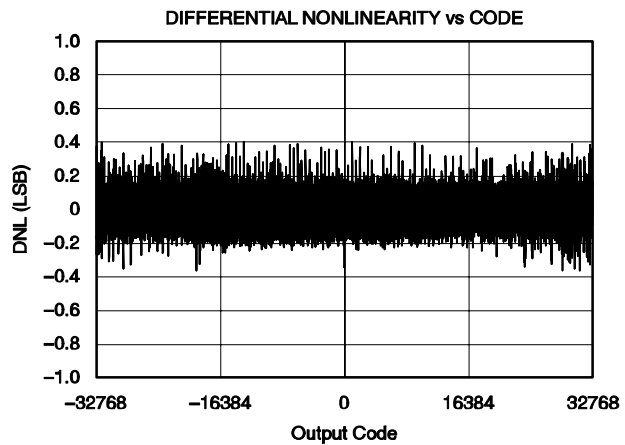

Figure 4

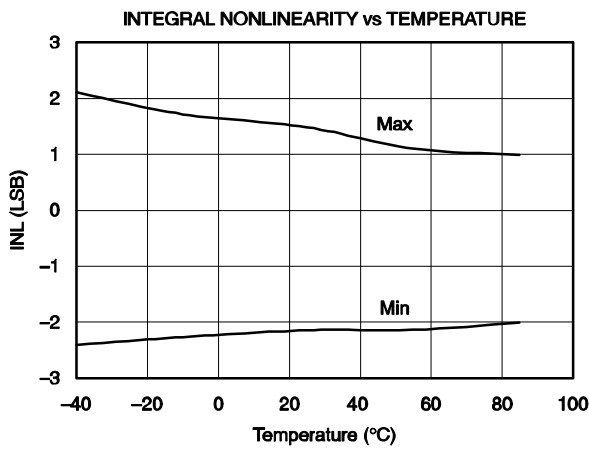

Figure 5

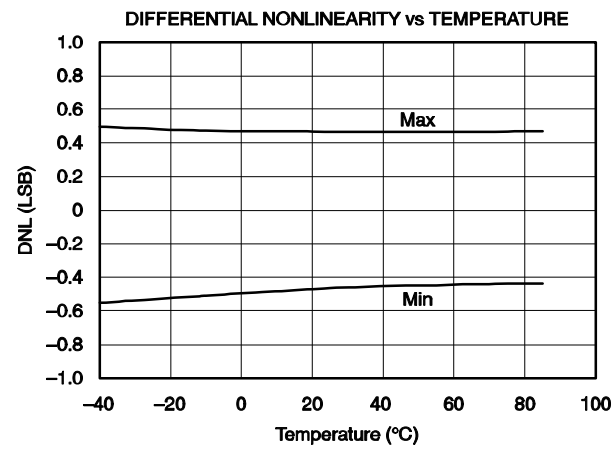

Figure 6

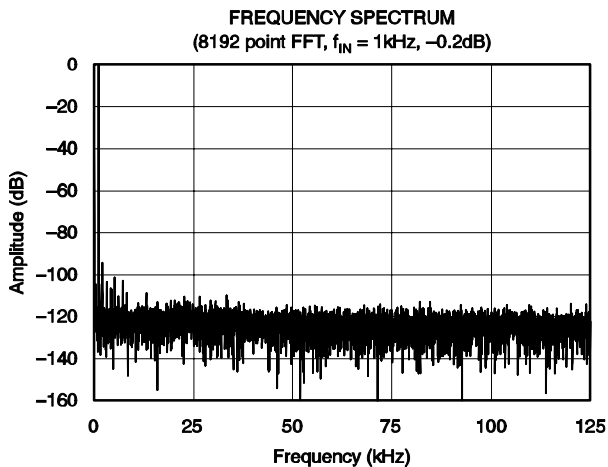

Figure 7

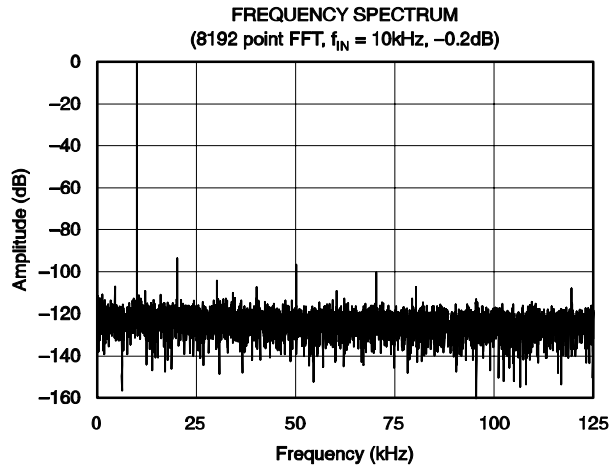

Figure 8

TYPICAL CHARACTERISTICS (continued)

At $T_A = +25^\circ\text{C}$, $+AV_{DD} = +DV_{DD} = +5\text{V}$, $BV_{DD} = 5\text{V}$, $V_{REF} = +2.5\text{V}$, $f_{CLK} = 5\text{MHz}$, and $f_{SAMPLE} = 250\text{kHz}$, unless otherwise noted.

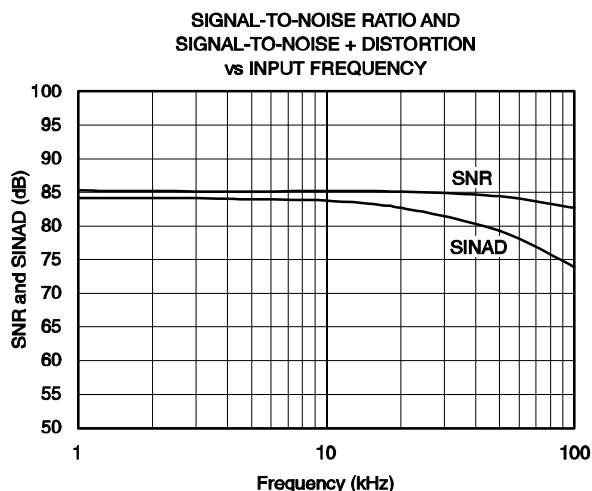

Figure 9

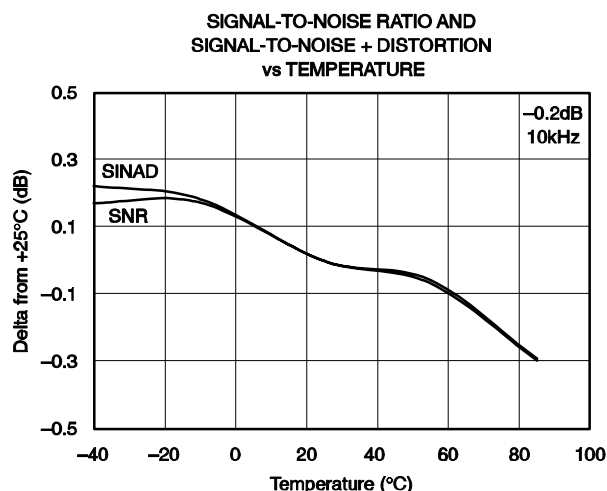

Figure 10

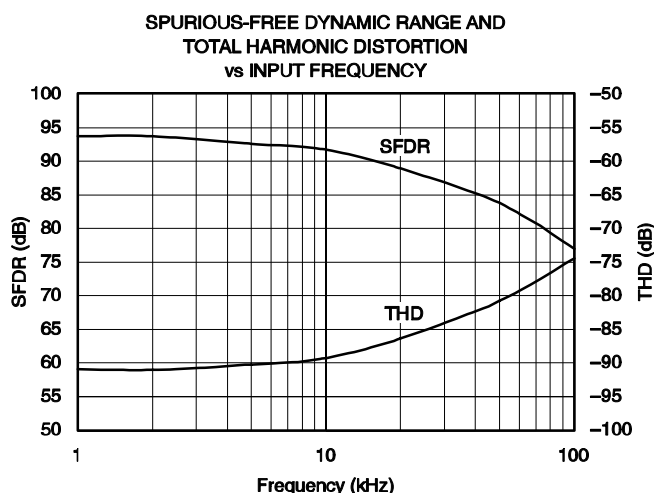

Figure 11

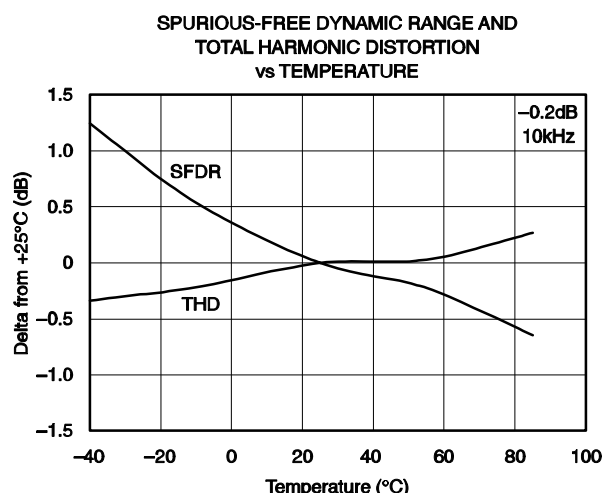

Figure 12

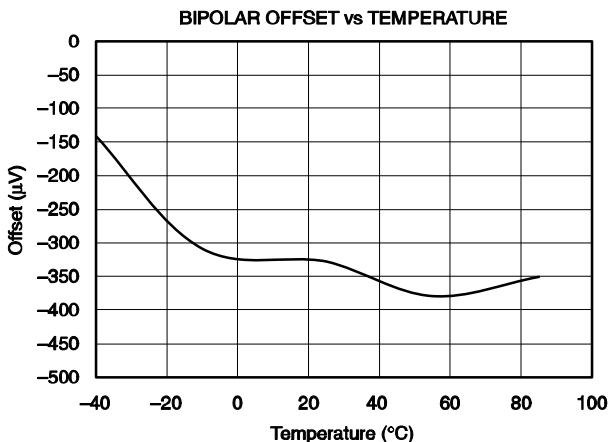

Figure 13

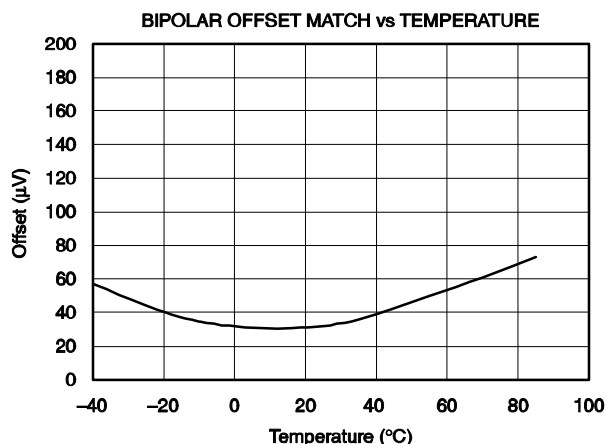

Figure 14

TYPICAL CHARACTERISTICS (continued)

At $T_A = +25^\circ\text{C}$, $+AV_{DD} = +DV_{DD} = +5\text{V}$, $BV_{DD} = 5\text{V}$, $V_{REF} = +2.5\text{V}$, $f_{CLK} = 5\text{MHz}$, and $f_{SAMPLE} = 250\text{kHz}$, unless otherwise noted.

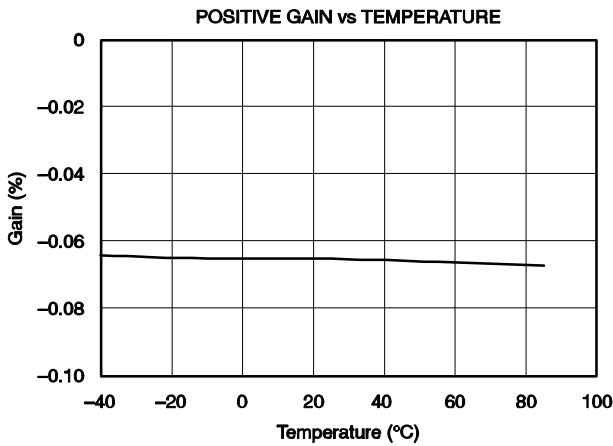

Figure 15

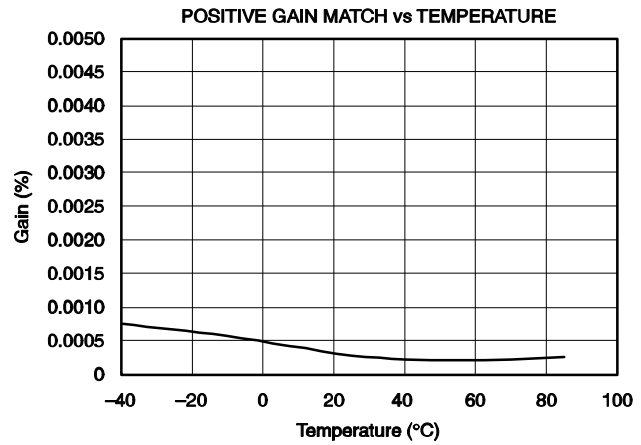

Figure 16

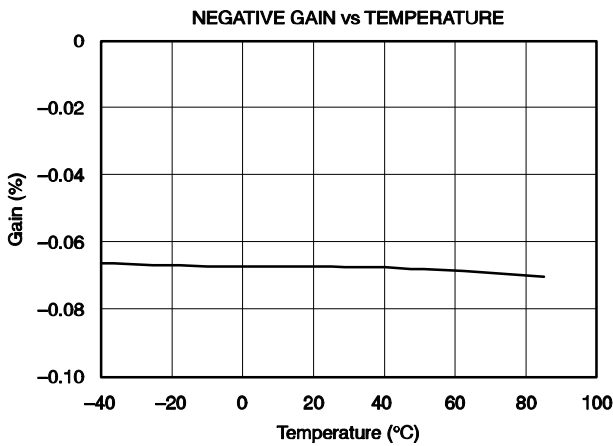

Figure 17

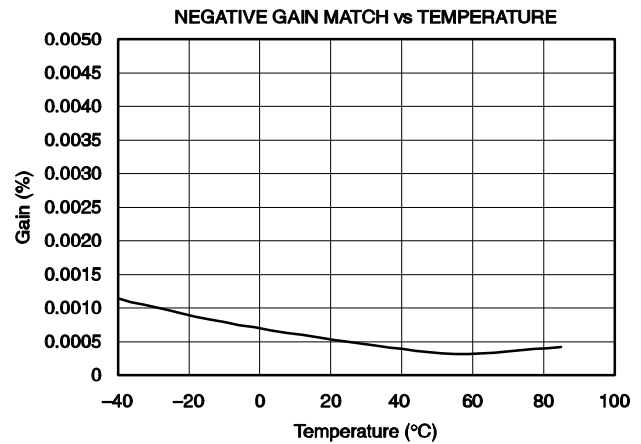

Figure 18

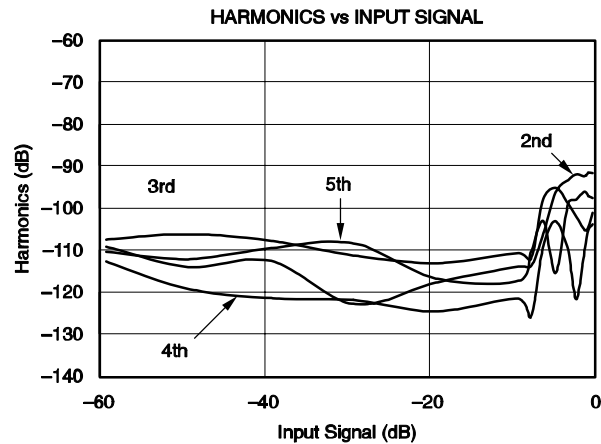

Figure 19

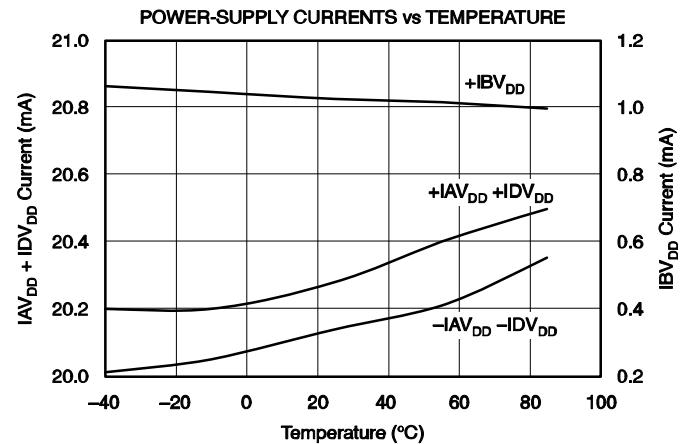

Figure 20

THEORY OF OPERATION

The ADS8342 is a classic successive approximation register (SAR) analog-to-digital converter (ADC). The architecture is based on capacitive charge redistribution that inherently includes a sample-and-hold function. The converter is fabricated on a 0.5 μ m CMOS process. The architecture and process allow the ADS8342 to acquire and convert an analog signal at up to 250,000 conversions per second, while consuming less than 200mW.

The ADS8342 requires an external reference, an external clock, and a dual power source ($\pm 5V$). When a digital interface voltage (BV_{DD}) different from +5V is desired, a triple power source is required ($\pm 5V$ and BV_{DD}). The external reference can be between 2V and 2.55V. The value of the reference voltage directly sets the range of the analog input.

The external clock can vary between 500kHz (25kHz throughput) and 5MHz (250kHz throughput). The minimum clock frequency is set by the leakage on the internal capacitors to the ADS8342.

The analog inputs to the ADC consists of two input pins: AINx and COMMON. The positive input to the ADC, AINx, is one of four analog channels (AIN0 to AIN3) and is selected by the front-end multiplexer. When a conversion is initiated, the differential input on these pins is sampled on to the internal capacitor array. While a conversion is in progress, both inputs are disconnected from any internal function.

MULTIPLEXER

The ADS8342 has an input multiplexer (MUX) that is used to select the desired positive analog input, and connect the sample-and-hold circuit and ADC to it. MUX address pins A0 and A1 are decoded to select the MUX channel; Table 1 shows information on selecting the input channel. Both the AINx and COMMON input signal voltages are sampled and held simultaneously to provide the best possible noise rejection.

Figure 21 shows a block diagram of the input multiplexer on the ADS8342. The differential input of the converter is derived from one of the four inputs in reference to the COMMON pin. Table 1 shows the relationship between the A1 and A0 control bits and the selection of the analog multiplexer. The control bits are provided via input pins; see the Digital Interface section of this data sheet for more details.

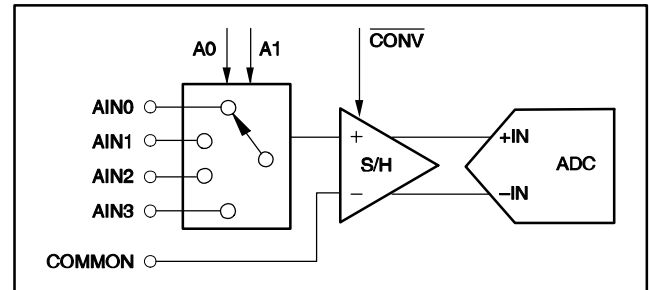

Figure 21. Simplified Diagram of the Analog Input

Table 1. Input Channel Selection

A1	A0	AIN0	AIN1	AIN2	AIN3	COMMON
0	0	+IN	—	—	—	-IN
0	1	—	+IN	—	—	-IN
1	0	—	—	+IN	—	-IN
1	1	—	—	—	+IN	-IN

When the converter enters the hold mode, the voltage difference between the +IN and -IN inputs (Figure 21) is captured on the internal capacitor array.

SAMPLE-AND-HOLD CIRCUIT

The sample-and-hold circuit on the ADS8342 allows the ADC to accurately convert an input sine wave of full-scale amplitude to 16-bit accuracy. The input bandwidth of the sample-and-hold circuit is greater than the Nyquist rate (Nyquist equals one-half of the sampling rate) of the ADC even when the ADC is operated at its maximum throughput rate of 250kHz.

Typical aperture delay time, or the time it takes for the ADS8342 to switch from sample mode to hold mode following the start of conversion, is 8ns. The average delta of repeated aperture delay values (also known as aperture jitter) is typically 50ps. These specifications reflect the ability of the ADS8342 to capture AC input signals accurately.

ANALOG INPUT

The analog input of ADS8342 is bipolar and pseudo-differential, as shown in Figure 22. The AIN0 to AIN3 and COMMON input pins allow for a differential input signal. The amplitude of the input is the difference between the AINx and COMMON inputs, or $AINx - COMMON$. Unlike some converters of this type, the COMMON input is not resampled later in the conversion cycle. When the converter goes into hold mode, the voltage difference between AINx and COMMON is captured on the internal capacitor array.

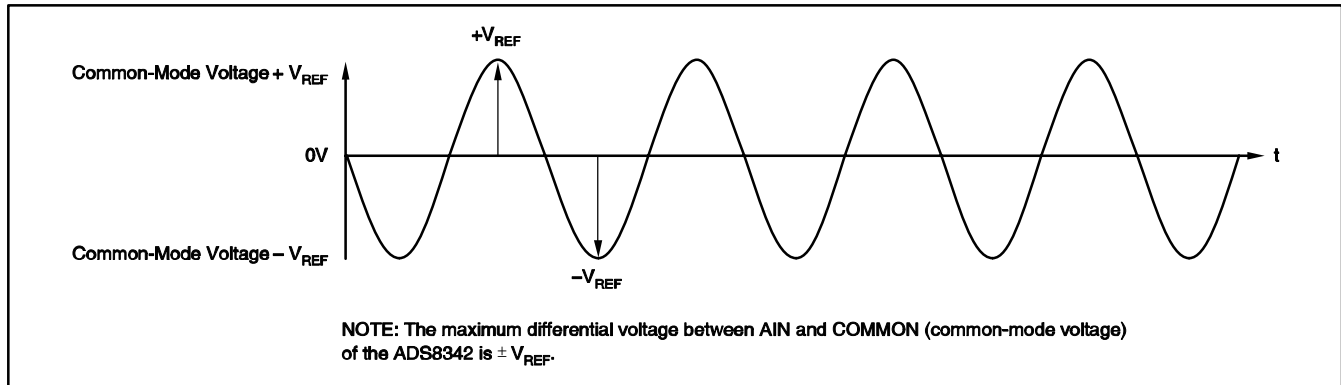

Figure 22. Pseudo-Differential Input Mode of the ADS8342

The range of the COMMON input is limited to $-0.1V$ to $+0.1V$. Due to this, the differential input can be used to reject signals that are common to both inputs in the specified range. Thus, the COMMON input is best used to sense a remote signal ground that may move slightly with respect to the local ground potential.

The general method for driving the analog input of the ADS8342 is shown in Figure 23 and Figure 24. The COMMON input is held at the common-mode voltage. The AINx input swings from $COMMON - V_{REF}$ to $COMMON + V_{REF}$, and the peak-to-peak amplitude is $2 \times V_{REF}$.

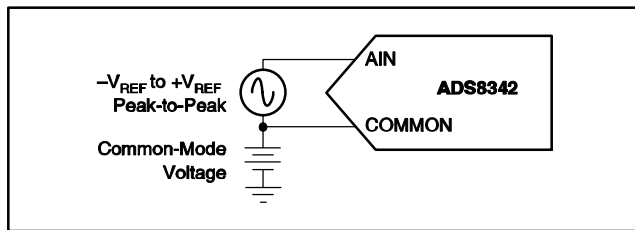

Figure 23. Method for Driving the ADS8342

The input current required by the analog inputs depends on a number of factors, such as sample rate, input voltage, and source impedance. Essentially, the current into the ADS8342 analog inputs charges the internal capacitor array during the sample period. After this capacitance has been fully charged, there is no further input current. The source of the analog input voltage must be able to charge the input capacitance (20pF) to a 16-bit settling level within 3 clock cycles (600ns). When the converter goes into hold mode, the input impedance is greater than 1GΩ.

Care must be taken regarding the absolute analog input voltage. To maintain the linearity of the converter, the COMMON input should not drop below $AGND - 0.1V$, or exceed $AGND + 0.1V$. The AINx input must always remain within the range of $COMMON - V_{REF}$ to $COMMON + V_{REF}$.

To minimize noise, low bandwidth input signals or low-pass filters must be used. In each case, care must be taken to ensure that the output impedance of the sources driving the AINx and COMMON inputs are matched.

Often, a small capacitor (100pF) between the positive and negative inputs helps to match their impedance. To obtain good performance from the ADS8342, the input circuit from Figure 24 is recommended.

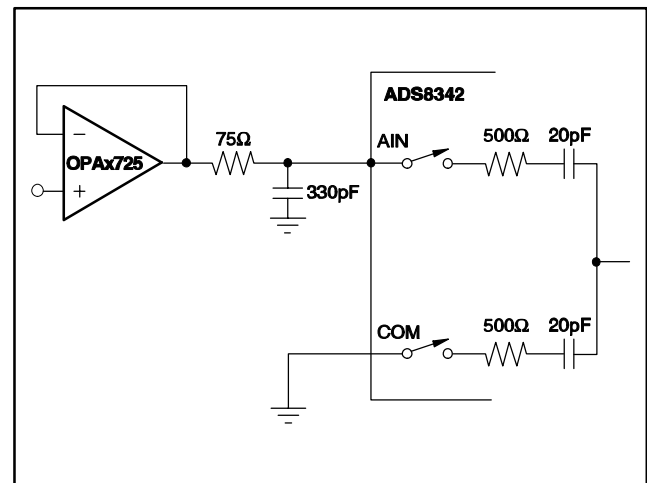

Figure 24. Single-Ended Method of Interfacing the ADS8342

REFERENCE AND REFGND INPUTS

The reference input of the ADS8342, REFIN, is buffered with an internal reference amplifier. The reference amplifier buffers the reference input from the switching currents needed to charge and discharge the internal capacitor DAC (CDAC), and therefore, the need to provide an external reference capable of supplying these switching currents is eliminated.

The reference ground input, REFGND, is connected directly to the CDAC. During the conversion, currents to charge and discharge the CDAC flow through the REFGND pin. For that reason, it is important that REFGND has a low-impedance connection to ground.

The external reference voltage sets the analog input voltage range. The ADS8342 can operate with a reference between 2.0V and 2.55V. There are several important implications to this.

As the reference voltage is reduced, the analog voltage weight of each digital output code is reduced. This is often referred to as the least significant bit (LSB) size and is equal to the reference voltage divided by 32,768. This means that any offset or gain error inherent in the ADC appears to increase (in terms of LSB size) as the reference voltage is reduced. For a reference voltage of 2V, the value of the LSB is 61.035µV. For a reference voltage of 2.5V, the LSB is 76.294µV.

The noise inherent in the converter also appears to increase with a lower LSB size. With a 2.5V reference, the internal noise of the converter typically contributes only 1.5LSBs peak-to-peak of potential error to the output code. When the external reference is 2.0V, the potential error contribution from the internal noise is larger (2LSBs). The errors due to the internal noise are Gaussian in nature and can be reduced by averaging consecutive conversion results.

To obtain optimum performance from the ADS8342, a 0.22µF ceramic capacitor must be connected as close as possible to the REFIN pin, to reduce noise coupling into this high impedance input. Because the reference voltage is internally buffered, a high output impedance reference source can be used without the need for an additional operational amplifier to drive the REFIN pin.

NOISE

The transition noise of the ADS8342 is extremely low, as shown in Figure 25 and Figure 26. These histograms were generated by applying a low-noise dc input and initiating 8192 conversions. The digital output of the ADC varies in output code due to the internal noise of the ADS8342. This is true for all 16-bit, SAR-type ADCs. Using a histogram to plot the output codes, the distribution should appear bell-shaped with the peak of the bell curve representing the nominal code for the input value. The ±1σ, ±2σ, and ±3σ distributions will represent the 68.3%, 95.5%, and 99.7%, respectively, of all codes. The transition noise is calculated by dividing the number of codes measured by 6, and yields the ±3σ distribution, or 99.7%, of all codes. Statistically, up to three codes could fall outside the distribution when executing 1000 conversions. The ADS8342, with less than three output codes for the ±3σ distribution, will yield < ±0.5LSBs of transition noise. Remember, to achieve this low-noise performance, the peak-to-peak noise of the input signal and reference must be < 50µV.

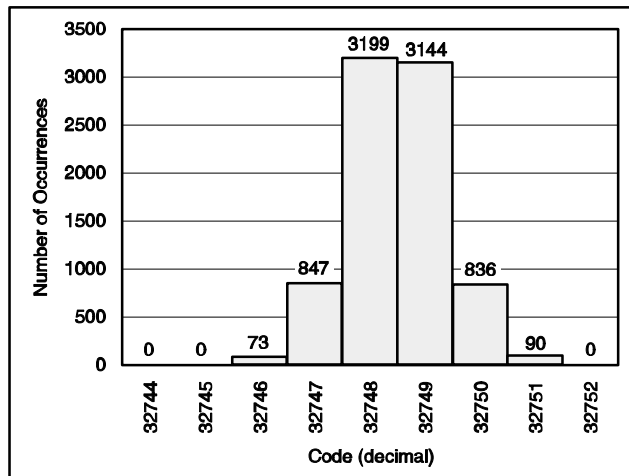

Figure 25. Histogram of 8192 Conversions of a DC Input at Code Transition

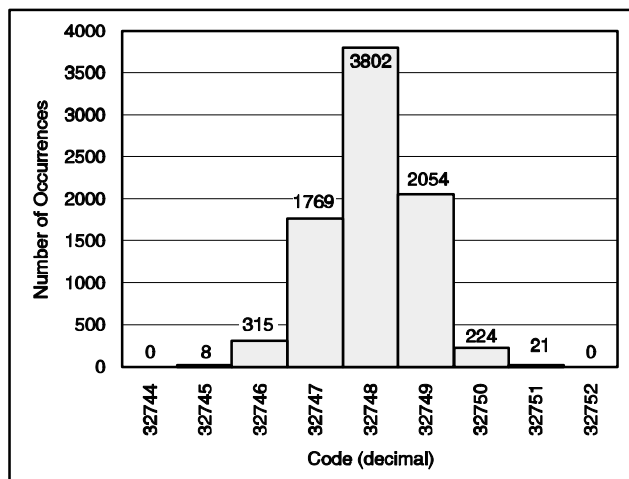

Figure 26. Histogram of 8192 Conversions of a DC Input at Code Center

Note that the effective number of bits (ENOB) figure is calculated based on the ADC signal-to-noise (SNR) ratio with a 10kHz, -0.2dB input signal. SNR is related to ENOB as follows:

$$SNR = 6.02 \times ENOB + 1.76$$

AVERAGING

The noise of the ADC can be compensated by averaging the digital codes. By averaging conversion results, transition noise is reduced by a factor of 1/√n, where n is the number of averages. For example, averaging four conversion results will reduce the transition noise from ±0.5LSB to ±0.25LSB. Averaging should only be used for input signals with frequencies near DC.

For AC signals, a digital filter can be used to low-pass filter and decimate the output codes. This works in a similar manner to averaging; for every decimation by 2, the signal-to-noise ratio will improve by 3dB.

DIGITAL INTERFACE

SIGNAL LEVELS

The ADS8342 digital interface accommodates different logic levels. The digital interface circuit is designed to operate using 2.7V to 5.5V logic levels. When the ADS8342 interface power-supply voltage is in the range of 4.5V to 5.5V (5V logic level), the ADS8342 can be connected directly to another 5V CMOS integrated circuit. If the ADS8342 interface power-supply voltage is in the range of 2.7V to 3.6V, the ADS8342 can be connected directly to another 3.3V LVCMOS integrated circuit. Note that digital inputs must not exceed BVDD by more than +0.3V.

TIMING AND CONTROL

The ADS8342 uses a parallel control interface consisting of the following digital input pins: \overline{CS} , \overline{RD} , \overline{CONV} , CLK, BYTE, A0, A1, CLKDIV0, and CLKDIV1. The following pins are digital outputs: BUSY, and DB1 to DB15. See Figure 2 (page 10) for a typical timing diagram.

The \overline{CS} input enables the digital interface of the ADS8342. \overline{CS} and \overline{CONV} start a conversion and \overline{CS} and \overline{RD} allow the output data to be read.

BYTE controls the data output bus width. A0 and A1 select the input MUX channel and CLKDIV0 and CLKDIV1 select the internal clock divider ratio.

The ADS8342 needs an external clock, CLK (pin 11), that controls the conversion rate of the ADC. A typical conversion cycle takes 20 clock cycles: 17 for conversion and 3 for signal acquisition. A 250kHz sample rate can be achieved with a 5MHz external clock and a clock divider ratio of 1. This corresponds to a 4μs maximum throughput period.

The following list describes some of the pins used:

CLK—An external clock must be provided to the ADS8342 via the digital input pin CLK. The frequency of the externally provided clock can be divided down inside the ADS8342 to provide a slower internal clock frequency for the ADS8342. The maximum internal clock frequency is 5MHz. The minimum internal clock period is 200ns (see Figure 2, t_{c1}). The clock duty cycle (HIGH/LOW) for an external clock of 5MHz can range up to 40/60 to 60/40.

CLKDIVx—The CLKDIVx digital input pins are decoded to select the clock frequency divider ratio that divides the external clock frequency for use internal to the ADS8342. This feature is useful for systems where a clock rate higher than

5MHz is available. For example, if a digital signal processor (DSP) uses a 20MHz clock, it is possible to set up the internal clock divider of the ADS8342 to divide the input clock frequency by four, to provide an internal clock speed of 5MHz. Table 2 shows the maximum applicable external clock frequency as a function of the CLKDIV0 and CLKDIV1 signals.

Table 2. Clock Divider Selection

CLKDIV1	CLKDIV0	CLOCK RATIO (1:n)	MAX INPUT FREQUENCY (MHz)	INTERNAL FREQUENCY (MHz)
0	0	1	5	5
0	1	2	10	5
1	0	4	20	5
1	1	8	20	2.5

Note that all timing diagrams and specifications are referenced to a clock divider ratio of 1:1 and an external clock frequency of 5MHz. For higher clock input frequencies, there will be a minor increase in power consumption and a possible increase in noise.

BUSY—The digital output signal, BUSY, provides an external indication that a conversion is taking place. BUSY goes high a maximum of 70ns after a conversion is initiated (see Figure 2, t_{d3}) and remains high until the end of the conversion. When BUSY goes low at the end of the conversion, the data from the conversion in progress is latched into the ADC output registers and is ready to be read. The BUSY signal remains low until another conversion is started by bringing \overline{CS} and \overline{CONV} low.

A0 AND A1—The digital inputs, A0 and A1, are MUX address lines used to select the positive analog input MUX channel to use for conversion. When a conversion is started with \overline{CS} and \overline{CONV} , the A_x inputs are latched into registers on the rising edge of \overline{CS} or \overline{CONV} . The latched MUX inputs control the state of the MUX for the next conversion following the current conversion. At the end of the conversion, the analog input returns to the sampling mode and samples the MUX channel that was latched during the previous conversion start.

BYTE—The BYTE signal can be used in conjunction with the \overline{RD} signal to control the output data bus width. If BYTE is held low, the ADS8342 operates in 16-bit output mode and the output data is read on pins DB15 to DB0. When an 8-bit bus interface is required, the 16-bit output word can be read using eight data lines by toggling the \overline{RD} and BYTE signals. The lower eight data output bits are read on output pins D7 to D0 when BYTE is low. The higher eight data output bits are read on the same output pins, D7 to D0, when BYTE is high (see Figure 2).

START OF A CONVERSION ($\overline{\text{CS}}$ AND $\overline{\text{CONV}}$)

$\overline{\text{CS}}$ and $\overline{\text{CONV}}$ are NORed together internally and must both be low to start a conversion. Bringing both the $\overline{\text{CS}}$ and $\overline{\text{CONV}}$ signals low for 40ns will start a conversion. Immediately after a conversion is started, the analog inputs, the selected MUX channel input, and the COMMON input are held by the sample-and-hold circuit (8ns).

The conversion starts on the next rising edge of the clock signal following the conversion start signal, if the conversion is started at least 40ns before the rising edge of the next clock (see Figure 2, t_{D1}). The $\overline{\text{CONV}}$ signal—and $\overline{\text{CS}}$ if it is not always held low—needs to go high 80ns before the rising edge of the second clock cycle of the conversion in order to reduce noise caused by bus activity on the control interface, which can disturb critical comparator decisions made during the conversion. Once $\overline{\text{CONV}}$ goes high, it has to stay high during the entire conversion period (see Figure 2).

After a conversion has been started, the rising edge of either $\overline{\text{CS}}$ or $\overline{\text{CONV}}$, whichever is first, latches the MUX address on pins A0 and A1 in a register. This address is used to select the channel that will be converted upon the next conversion start. After a conversion is finished (17 clock cycles), the sample-and-hold circuit switches from hold mode to sample mode in order to sample the MUX channel address that was latched during the previous conversion start. The start of the next conversion can be initiated after the input capacitor of the ADS8342 is fully charged. This signal acquisition time depends on the driving amplifier, but should be at least 600ns.

For best performance, none of the input control lines should change state after 80ns prior to the rising edge of the second clock in the conversion, as previously described.

READING DATA ($\overline{\text{RD}}$, $\overline{\text{CS}}$)— $\overline{\text{CS}}$ and $\overline{\text{RD}}$ are NORed together internally and both must be low to enable the data outputs. During the conversion, the data outputs are tri-state and cannot be read. After a conversion has completed, both $\overline{\text{CS}}$ and $\overline{\text{RD}}$ must be low for at least 40ns (see Figure 2, t_{w5}) to enable the outputs. The output data can be latched into external registers using the rising edge of $\overline{\text{RD}}$ and another conversion can be started 1.5 clocks following the rising edge of $\overline{\text{RD}}$. Before bringing $\overline{\text{RD}}$ back low for a subsequent read command, it must remain high for at least 40ns (see Figure 2, t_{w6}).

When BUSY rises after a conversion is initiated, the data outputs will become tri-state regardless of the state of $\overline{\text{RD}}$. Noise will be generated when the enabled outputs transition to tri-state, which can affect the results of the conversion. To obtain best performance, it is recommended to read the output data immediately after the BUSY signal goes low at the end of conversion and to bring $\overline{\text{RD}}$ high prior to starting the next conversion.

DATA FORMAT

The output data from the ADS8342 is in binary two's complement (BTC) format (see Figure 27). This figure represents the ideal output code for a given input voltage and does not include the effects of offset, gain error, or noise.

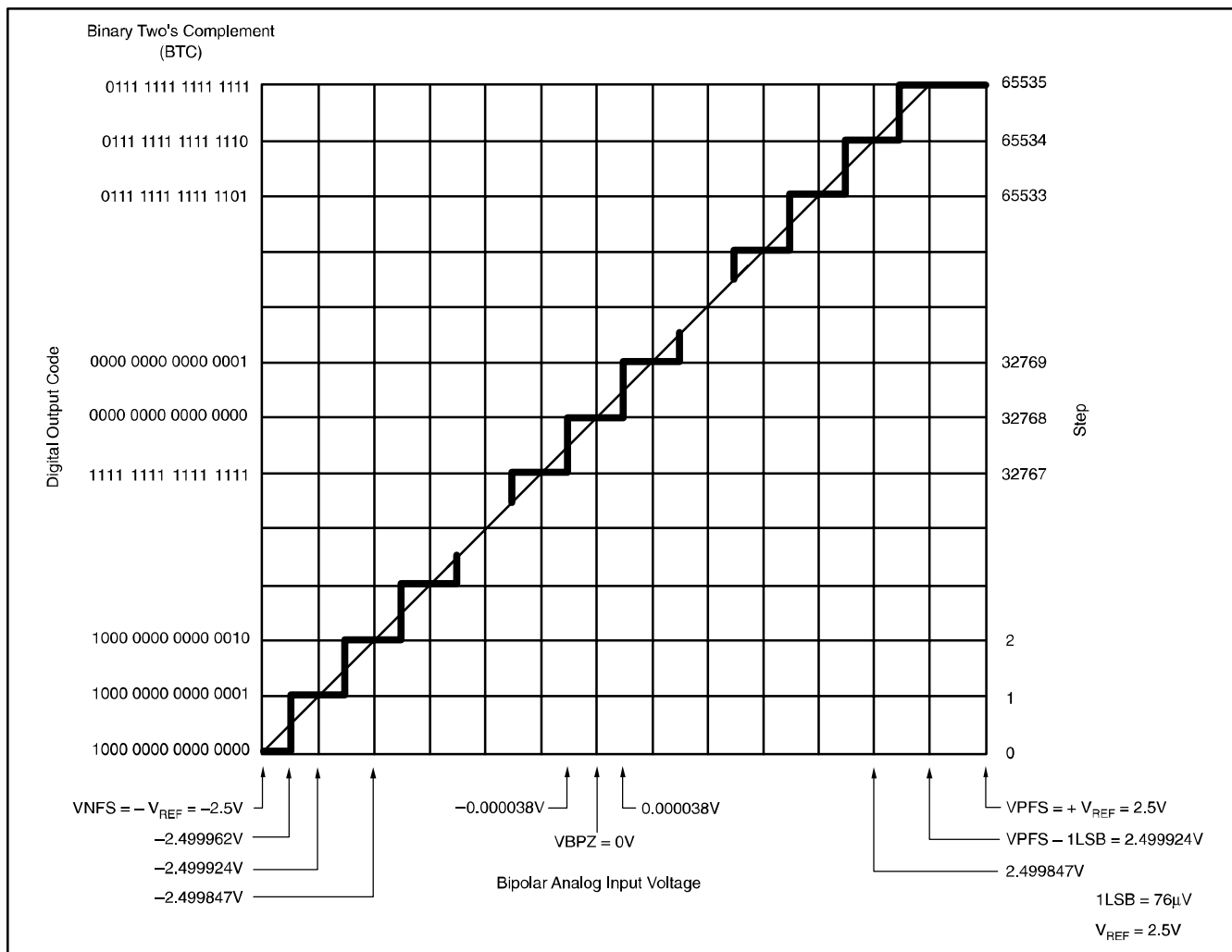

Figure 27. Ideal Conversion Characteristics ($V_{CM} = 0V$ and $V_{REF} = 2.5V$)

LAYOUT

For optimum performance, care should be taken with the physical layout of the ADS8342 circuitry. This is particularly true if the ADC is approaching the maximum throughput rate.

During the ADC conversion, the basic SAR architecture is sensitive to glitches or sudden changes in the power supply, reference, ground connections, and digital inputs. Such glitches might originate from switching power supplies, nearby digital logic, or high power devices. The degree of error in the digital output depends on the reference voltage, layout, and the exact timing of the external event. The digital output error can change if the external event changes in time with respect to the CLK input.

With this in mind, power to the ADS8342 must be quiet and well bypassed. The $0.1\mu F$ ceramic bypass capacitors should be placed as close to the device as possible.

In addition, a $1\mu F$ to $4.7\mu F$ capacitor is recommended. If needed, an even larger capacitor and a 5Ω or 10Ω series resistor can be used to low-pass filter a noisy supply.

The ADS8342 draws very little current from an external reference because the reference voltage is internally buffered. The V_{REF} pin should be bypassed with a $0.22\mu F$ capacitor. An additional larger capacitor can also be used, if desired. If the reference voltage originates from an op amp, make sure that it can drive the bypass capacitor or capacitors without oscillation.

The REFGND and GND pins should be connected to a quiet ground. In many cases, this will be the analog ground. Avoid connections that are too near to the grounding point of a microcontroller or DSP. The ideal layout should include an analog ground plane dedicated to the converter and associated analog circuitry.

APPLICATION INFORMATION

Figure 1 shows a typical connection diagram. Different connection diagrams to DSPs or microcontrollers are shown in Figure 28 thru Figure 31.

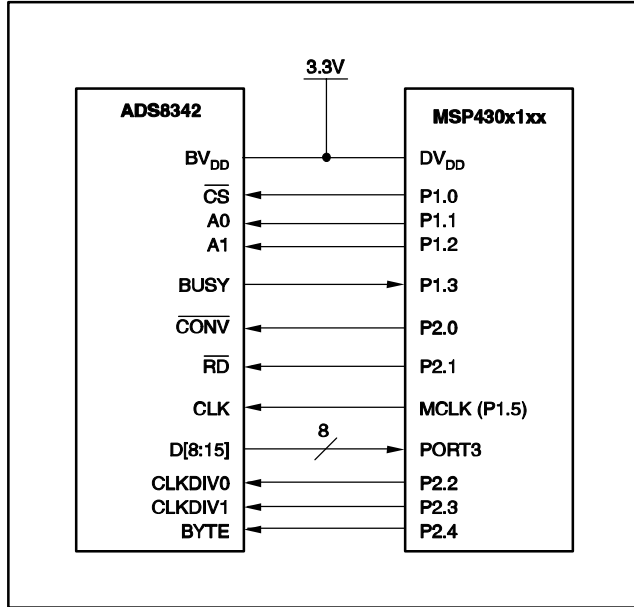

Figure 28.

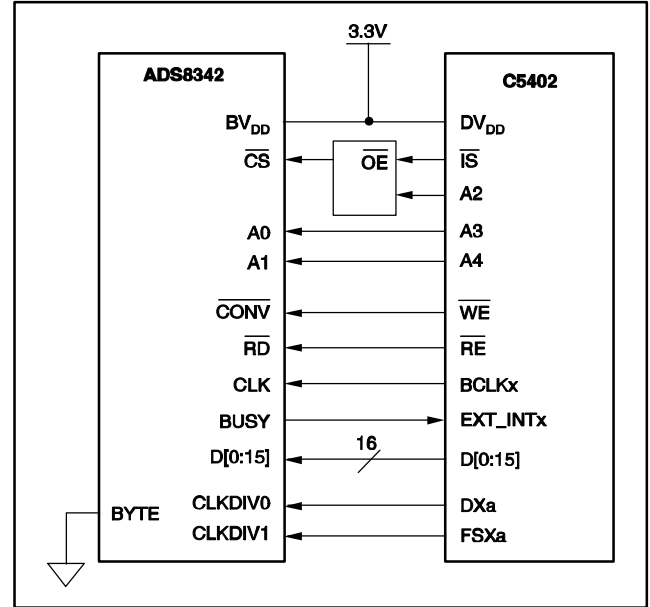

Figure 30.

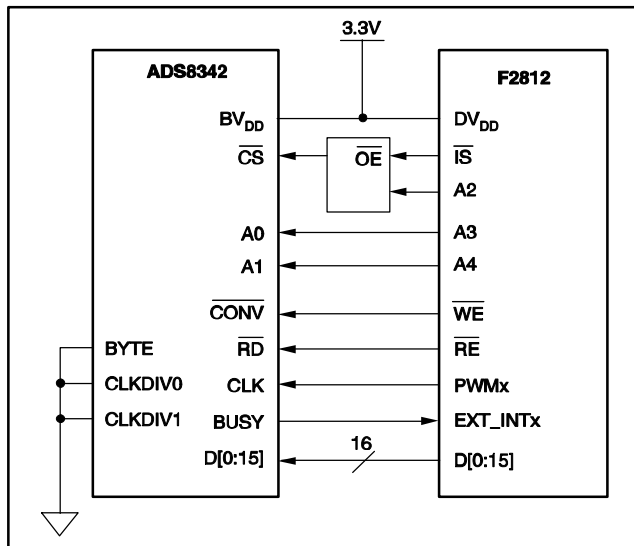

Figure 29.

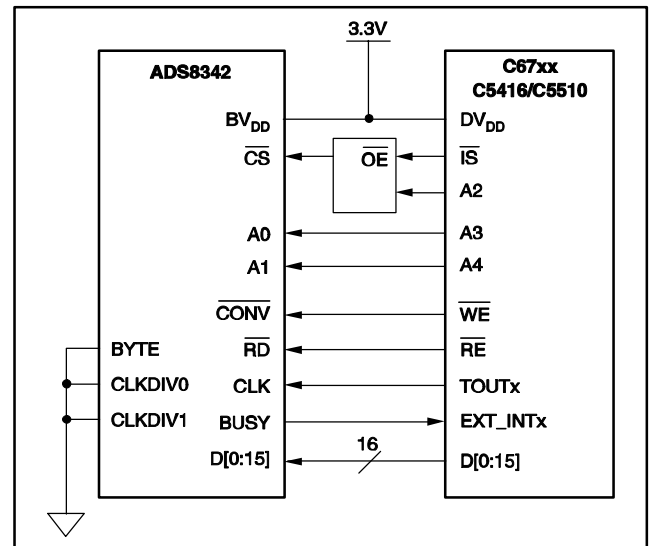

Figure 31.

PACKAGING INFORMATION

Orderable Device	Status (1)	Package Type	Package Drawing	Pins	Package Qty	Eco Plan (2)	Lead/Ball Finish (6)	MSL Peak Temp (3)	Op Temp (°C)	Device Marking (4/5)	Samples
ADS8342IBPFBT	ACTIVE	TQFP	PFB	48	250	Green (RoHS & no Sb/Br)	CU NIPDAU	Level-2-260C-1 YEAR	-40 to 85	ADS8342I B	Samples
ADS8342IPFBT	ACTIVE	TQFP	PFB	48	250	Green (RoHS & no Sb/Br)	CU NIPDAU	Level-2-260C-1 YEAR	-40 to 85	ADS8342I	Samples
ADS8342IPFBTG4	ACTIVE	TQFP	PFB	48	250	Green (RoHS & no Sb/Br)	CU NIPDAU	Level-2-260C-1 YEAR	-40 to 85	ADS8342I	Samples

(1) The marketing status values are defined as follows:

ACTIVE: Product device recommended for new designs.

LIFEBUY: TI has announced that the device will be discontinued, and a lifetime-buy period is in effect.

NRND: Not recommended for new designs. Device is in production to support existing customers, but TI does not recommend using this part in a new design.

PREVIEW: Device has been announced but is not in production. Samples may or may not be available.

OBsolete: TI has discontinued the production of the device.

(2) Eco Plan - The planned eco-friendly classification: Pb-Free (RoHS), Pb-Free (RoHS Exempt), or Green (RoHS & no Sb/Br) - please check <http://www.ti.com/productcontent> for the latest availability information and additional product content details.

TBD: The Pb-Free/Green conversion plan has not been defined.

Pb-Free (RoHS): TI's terms "Lead-Free" or "Pb-Free" mean semiconductor products that are compatible with the current RoHS requirements for all 6 substances, including the requirement that lead not exceed 0.1% by weight in homogeneous materials. Where designed to be soldered at high temperatures, TI Pb-Free products are suitable for use in specified lead-free processes.

Pb-Free (RoHS Exempt): This component has a RoHS exemption for either 1) lead-based flip-chip solder bumps used between the die and package, or 2) lead-based die adhesive used between the die and leadframe. The component is otherwise considered Pb-Free (RoHS compatible) as defined above.

Green (RoHS & no Sb/Br): TI defines "Green" to mean Pb-Free (RoHS compatible), and free of Bromine (Br) and Antimony (Sb) based flame retardants (Br or Sb do not exceed 0.1% by weight in homogeneous material)

(3) MSL, Peak Temp. - The Moisture Sensitivity Level rating according to the JEDEC industry standard classifications, and peak solder temperature.

(4) There may be additional marking, which relates to the logo, the lot trace code information, or the environmental category on the device.

(5) Multiple Device Markings will be inside parentheses. Only one Device Marking contained in parentheses and separated by a "~" will appear on a device. If a line is indented then it is a continuation of the previous line and the two combined represent the entire Device Marking for that device.

(6) Lead/Ball Finish - Orderable Devices may have multiple material finish options. Finish options are separated by a vertical ruled line. Lead/Ball Finish values may wrap to two lines if the finish value exceeds the maximum column width.

Important Information and Disclaimer: The information provided on this page represents TI's knowledge and belief as of the date that it is provided. TI bases its knowledge and belief on information provided by third parties, and makes no representation or warranty as to the accuracy of such information. Efforts are underway to better integrate information from third parties. TI has taken and

continues to take reasonable steps to provide representative and accurate information but may not have conducted destructive testing or chemical analysis on incoming materials and chemicals. TI and TI suppliers consider certain information to be proprietary, and thus CAS numbers and other limited information may not be available for release.

In no event shall TI's liability arising out of such information exceed the total purchase price of the TI part(s) at issue in this document sold by TI to Customer on an annual basis.

TAPE AND REEL INFORMATION



QUADRANT ASSIGNMENTS FOR PIN 1 ORIENTATION IN TAPE



*All dimensions are nominal

Device	Package Type	Package Drawing	Pins	SPQ	Reel Diameter (mm)	Reel Width W1 (mm)	A0 (mm)	B0 (mm)	K0 (mm)	P1 (mm)	W (mm)	Pin1 Quadrant
ADS8342IBPFBT	TQFP	PFB	48	250	180.0	17.0	9.6	9.6	1.5	12.0	16.0	Q2
ADS8342IPFBT	TQFP	PFB	48	250	180.0	17.0	9.6	9.6	1.5	12.0	16.0	Q2

TAPE AND REEL BOX DIMENSIONS

*All dimensions are nominal

Device	Package Type	Package Drawing	Pins	SPQ	Length (mm)	Width (mm)	Height (mm)
ADS8342IBPFBT	TQFP	PFB	48	250	210.0	185.0	35.0
ADS8342IPFBT	TQFP	PFB	48	250	210.0	185.0	35.0

PFB (S-PQFP-G48)

PLASTIC QUAD FLATPACK



- NOTES: A. All linear dimensions are in millimeters.
 B. This drawing is subject to change without notice.
 C. Falls within JEDEC MS-026

PFB (S-PQFP-G48)



4209366/A 03/08

- NOTES:
- A. All linear dimensions are in millimeters.
 - B. This drawing is subject to change without notice.
 - C. Publication IPC-7351 is recommended for alternate designs.
 - D. Laser cutting apertures with trapezoidal walls and also rounding corners will offer better paste release. Customers should contact their board assembly site for stencil design recommendations. Refer to IPC-7525.
 - E. Customers should contact their board fabrication site for solder mask tolerances between and around signal pads.

IMPORTANT NOTICE

Texas Instruments Incorporated (TI) reserves the right to make corrections, enhancements, improvements and other changes to its semiconductor products and services per JESD46, latest issue, and to discontinue any product or service per JESD48, latest issue. Buyers should obtain the latest relevant information before placing orders and should verify that such information is current and complete.

TI's published terms of sale for semiconductor products (<http://www.ti.com/sc/docs/stdterms.htm>) apply to the sale of packaged integrated circuit products that TI has qualified and released to market. Additional terms may apply to the use or sale of other types of TI products and services.

Reproduction of significant portions of TI information in TI data sheets is permissible only if reproduction is without alteration and is accompanied by all associated warranties, conditions, limitations, and notices. TI is not responsible or liable for such reproduced documentation. Information of third parties may be subject to additional restrictions. Resale of TI products or services with statements different from or beyond the parameters stated by TI for that product or service voids all express and any implied warranties for the associated TI product or service and is an unfair and deceptive business practice. TI is not responsible or liable for any such statements.

Buyers and others who are developing systems that incorporate TI products (collectively, "Designers") understand and agree that Designers remain responsible for using their independent analysis, evaluation and judgment in designing their applications and that Designers have full and exclusive responsibility to assure the safety of Designers' applications and compliance of their applications (and of all TI products used in or for Designers' applications) with all applicable regulations, laws and other applicable requirements. Designer represents that, with respect to their applications, Designer has all the necessary expertise to create and implement safeguards that (1) anticipate dangerous consequences of failures, (2) monitor failures and their consequences, and (3) lessen the likelihood of failures that might cause harm and take appropriate actions. Designer agrees that prior to using or distributing any applications that include TI products, Designer will thoroughly test such applications and the functionality of such TI products as used in such applications.

TI's provision of technical, application or other design advice, quality characterization, reliability data or other services or information, including, but not limited to, reference designs and materials relating to evaluation modules, (collectively, "TI Resources") are intended to assist designers who are developing applications that incorporate TI products; by downloading, accessing or using TI Resources in any way, Designer (individually or, if Designer is acting on behalf of a company, Designer's company) agrees to use any particular TI Resource solely for this purpose and subject to the terms of this Notice.

TI's provision of TI Resources does not expand or otherwise alter TI's applicable published warranties or warranty disclaimers for TI products, and no additional obligations or liabilities arise from TI providing such TI Resources. TI reserves the right to make corrections, enhancements, improvements and other changes to its TI Resources. TI has not conducted any testing other than that specifically described in the published documentation for a particular TI Resource.

Designer is authorized to use, copy and modify any individual TI Resource only in connection with the development of applications that include the TI product(s) identified in such TI Resource. NO OTHER LICENSE, EXPRESS OR IMPLIED, BY ESTOPPEL OR OTHERWISE TO ANY OTHER TI INTELLECTUAL PROPERTY RIGHT, AND NO LICENSE TO ANY TECHNOLOGY OR INTELLECTUAL PROPERTY RIGHT OF TI OR ANY THIRD PARTY IS GRANTED HEREIN, including but not limited to any patent right, copyright, mask work right, or other intellectual property right relating to any combination, machine, or process in which TI products or services are used. Information regarding or referencing third-party products or services does not constitute a license to use such products or services, or a warranty or endorsement thereof. Use of TI Resources may require a license from a third party under the patents or other intellectual property of the third party, or a license from TI under the patents or other intellectual property of TI.

TI RESOURCES ARE PROVIDED "AS IS" AND WITH ALL FAULTS. TI DISCLAIMS ALL OTHER WARRANTIES OR REPRESENTATIONS, EXPRESS OR IMPLIED, REGARDING RESOURCES OR USE THEREOF, INCLUDING BUT NOT LIMITED TO ACCURACY OR COMPLETENESS, TITLE, ANY EPIDEMIC FAILURE WARRANTY AND ANY IMPLIED WARRANTIES OF MERCHANTABILITY, FITNESS FOR A PARTICULAR PURPOSE, AND NON-INFRINGEMENT OF ANY THIRD PARTY INTELLECTUAL PROPERTY RIGHTS. TI SHALL NOT BE LIABLE FOR AND SHALL NOT DEFEND OR INDEMNIFY DESIGNER AGAINST ANY CLAIM, INCLUDING BUT NOT LIMITED TO ANY INFRINGEMENT CLAIM THAT RELATES TO OR IS BASED ON ANY COMBINATION OF PRODUCTS EVEN IF DESCRIBED IN TI RESOURCES OR OTHERWISE. IN NO EVENT SHALL TI BE LIABLE FOR ANY ACTUAL, DIRECT, SPECIAL, COLLATERAL, INDIRECT, PUNITIVE, INCIDENTAL, CONSEQUENTIAL OR EXEMPLARY DAMAGES IN CONNECTION WITH OR ARISING OUT OF TI RESOURCES OR USE THEREOF, AND REGARDLESS OF WHETHER TI HAS BEEN ADVISED OF THE POSSIBILITY OF SUCH DAMAGES.

Unless TI has explicitly designated an individual product as meeting the requirements of a particular industry standard (e.g., ISO/TS 16949 and ISO 26262), TI is not responsible for any failure to meet such industry standard requirements.

Where TI specifically promotes products as facilitating functional safety or as compliant with industry functional safety standards, such products are intended to help enable customers to design and create their own applications that meet applicable functional safety standards and requirements. Using products in an application does not by itself establish any safety features in the application. Designers must ensure compliance with safety-related requirements and standards applicable to their applications. Designer may not use any TI products in life-critical medical equipment unless authorized officers of the parties have executed a special contract specifically governing such use. Life-critical medical equipment is medical equipment where failure of such equipment would cause serious bodily injury or death (e.g., life support, pacemakers, defibrillators, heart pumps, neurostimulators, and implantables). Such equipment includes, without limitation, all medical devices identified by the U.S. Food and Drug Administration as Class III devices and equivalent classifications outside the U.S.

TI may expressly designate certain products as completing a particular qualification (e.g., Q100, Military Grade, or Enhanced Product). Designers agree that it has the necessary expertise to select the product with the appropriate qualification designation for their applications and that proper product selection is at Designers' own risk. Designers are solely responsible for compliance with all legal and regulatory requirements in connection with such selection.

Designer will fully indemnify TI and its representatives against any damages, costs, losses, and/or liabilities arising out of Designer's non-compliance with the terms and provisions of this Notice.