

Middle Power Class-D Speaker Amplifier series

15W+15W

Class D Speaker Amplifier for Digital Input



BD5452AMUV

●General Description

BD5452AMUV is a Class D Speaker Amplifier designed for Flat-panel TVs in particular for space-saving and low-power consumption, delivers an output power of 15W+15W. This IC employs state-of-the-art Bipolar, CMOS, and DMOS (BCD) process technology. With this technology, the IC can achieve high efficiency. In addition, the IC is packaged in a compact reverse heat radiation type power package to achieve low power consumption and low heat generation and eliminates necessity of external heat-sink up to a total output power of 30W. This product satisfies both needs for drastic downsizing, low-profile structures and many function, high quality playback of sound system.

●Features

- This IC has one system of digital audio interface. (I2S format, SDATA: 16 / 20 / 24bit, LRCLK: 32kHz / 44.1kHz / 48kHz, BCLK: 64fs(fixed), MCLK: 256fs / 512fs)
- Low supply current at RESET mode.
- The decrease in sound quality because of the change of the power supply voltage is prevented with the feedback circuitry of the output. In addition, a low noise and low distortion are achieved.
- Eliminate large electrolytic-capacitors for high performance of Power Supply Rejection.
- Power Limit Function. (at RL=8Ω, 10W /5W /OFF)
- Available for Monaural mode.
- Within the wide range of the power supply voltage, it is possible to operate in a single power supply. (10 to 18V)
- It contributes to miniaturizing, making to the thin type, and the power saving of the system by high efficiency and low heat.
- Eliminates pop noise generated when the power supply goes on/off, or when the power supply is suddenly shut off. High quality muting performance is realized by using the soft-muting technology.
- This IC is a highly reliable design to which it has various protection functions. (High temperature protection, under voltage protection, Output short protection, Output DC voltage protection and Clock stop protection, (MCLK, BCLK, LRCLK)
- Small package (VQFN032V5050 package) contributes to reduction of PCB area.

●Applications

- Flat Panel TVs (LCD, Plasma), Home Audio, Desktop PC, Amusement equipments, Electronic Music equipments, etc.

●Key Specifications

- Supply voltage: 10V to 18V
- Speaker output power: 15W+15W
(VCC=16V, RL=8Ω, Power Limit=Off)
- Total harmonic distortion: 0.08%(Po=4.5W)
- Crosstalk: 80dB(Typ.)
- PSRR: 65dB(Typ.)
- Output noise voltage: 100μVrms(Typ.)
- Standby current: 100μA (Typ.)
- Operating temperature range: -25°C to +85°C

●Package(s)

VQFN032V5050 W(Typ.) x D(Typ.) x H(Max.)
5.00mm x 5.00mm x 1.00mm

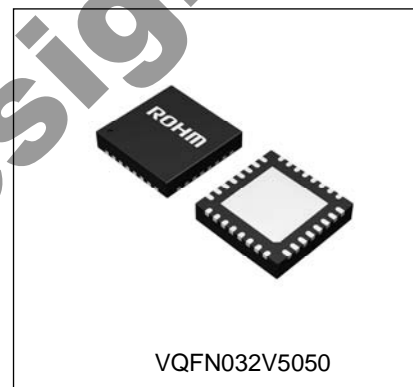

●Typical Application Circuit

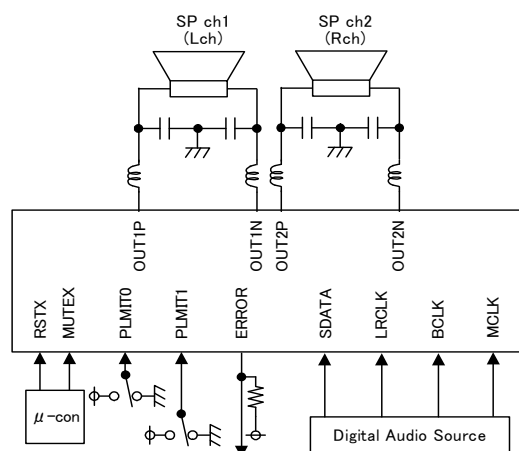

Figure 1. Typical Application Circuit

● Pin Configuration

(TOP VIEW)

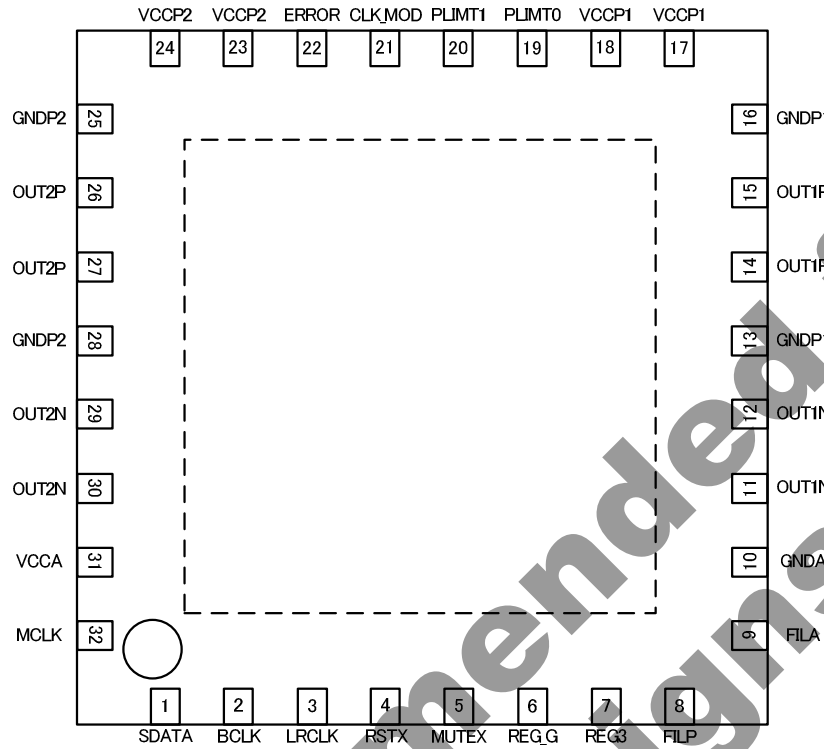

Figure 2. Pin Configuration

● Pin Description

Pin No.	Symbol	I/O	Pin No.	Symbol	I/O	Pin No.	Symbol	I/O	Pin No.	Symbol	I/O
1	SDATA	I	9	FILA	O	17	VCCP1	I	25	GNDP2	-
2	BCLK	I	10	GNDP1	-	18	VCCP1	I	26	OUT2P	O
3	LRCLK	I	11	OUT1N	O	19	PLIMT0	I	27	OUT2P	O
4	RSTX	I	12	OUT1N	O	20	PLIMT1	I	28	GNDP2	-
5	MUTEX	I	13	GNDP1	-	21	CLK_MOD	I	29	OUT2N	O
6	REG_G	O	14	OUT1P	O	22	ERROR	O	30	OUT2N	O
7	REG3	O	15	OUT1P	O	23	VCCP2	I	31	VCCA	I
8	FILP	O	16	GNDP1	-	24	VCCP2	I	32	MCLK	I

●Block Diagram

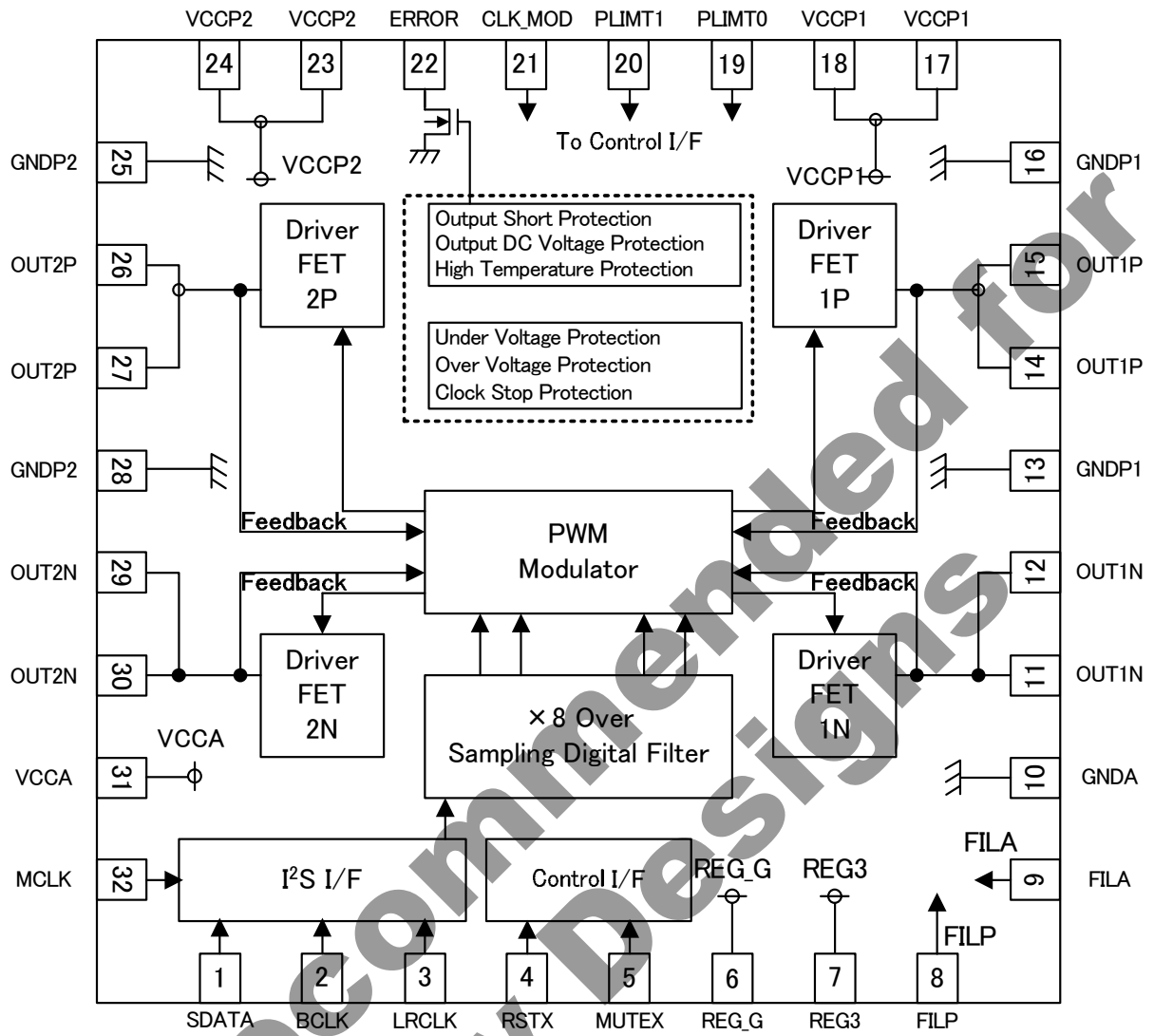

Figure 3. Block Diagram

●Absolute Maximum Ratings

Item	Symbol	Limit	Unit	Conditions
Supply voltage	VCCmax	-0.3 to 22	V	Pin 17,18,23,24,31 ※1 ※2
Power dissipation	Pd	3.26	W	※3
		4.56	W	※4
Input voltage	VIN	-0.3 to 4.5	V	Pin 1 to 5, 19 to 21, 32
Terminal voltage 1	VPIN1	-0.3 to 7.0	V	Pin 6,8,9
Terminal voltage 2	VPIN2	-0.3 to 4.5	V	Pin 7
Terminal voltage 3 ※5	VPIN3	-0.3 to 22	V	Pin 11,12,14,15,26,27,29,30
Open-drain terminal voltage	VERR	-0.3 to 22	V	Pin 22
Operating temperature range	Topr	-25 to +85	°C	
Storage temperature range	Tstg	-55 to +150	°C	
Maximum junction temperature	Tjmax	+150	°C	

※1 The voltage that can be applied reference to GND (Pin 10, 13, 16, 25, 28).

※2 Do not, however exceed Pd and Tjmax=150°C.

※3 74.2mm×74.2mm×1.6mm, FR4, 4-layer glass epoxy board

(Top and bottom layer back copper foil size: 20.2mm², 2nd and 3rd layer back copper foil size: 5505mm²)

Derating in done at 26.1mW/°C for operating above Ta=25°C. There are thermal via on the board.

※5 (Reference info.) It is confirmed to this terminal to be able to tolerate undershoot within the range of the following Figure 4 with ROHM evaluation board.

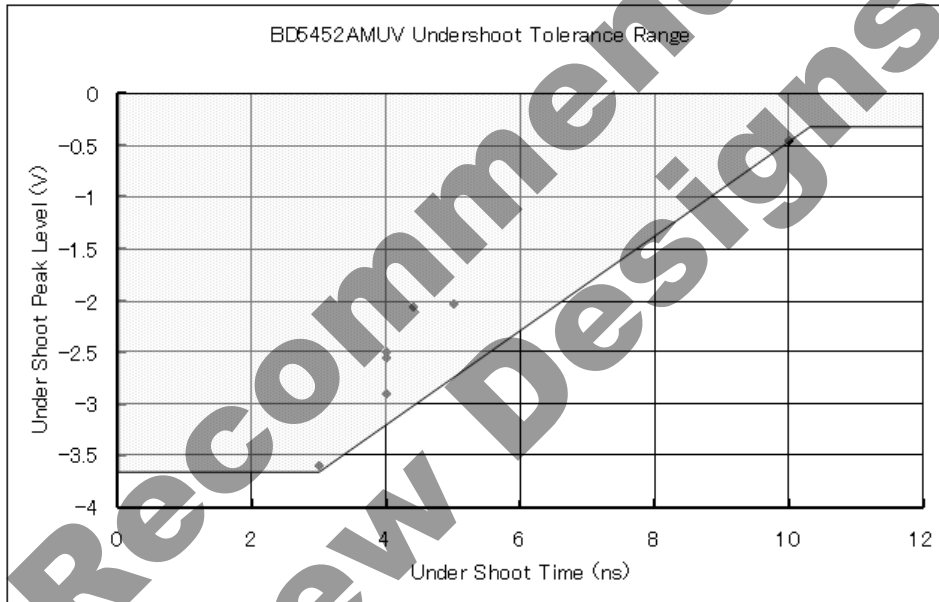

Figure 4. Undershoot Tolerance Range

●Recommended Operating Rating

Item	Symbol	Limit	Unit	Conditions
Supply voltage	Vcc	10 to 18	V	
Minimum load impedance	RL	3.6	Ω	Vcc ≤ 18V
		3.2	Ω	Vcc ≤ 16V

●Electrical Characteristics

(Unless otherwise specified Ta=25°C, Vcc=12V, f=1kHz, RL=8Ω, RSTX=3.3V, MUTEX=3.3V, PLIMT0=L, PLIMT1=L, fs=48kHz, MCLK=256fs,
Output LC filter : L=10uH, C=0.1uF)

Item	Symbol	Limit			Unit	Pin Condition
		Min	Typ	Max		
Total circuit						
Circuit current (Reset mode)	ICC1	-	0.1	0.2	mA	No load, RSTX=0V, MUTEX=0V
Circuit current (Mute mode)	ICC2	-	15	25	mA	No load, RSTX=3.3V, MUTEX=0V
Circuit current (Sampling mode)	ICC3	-	50	80	mA	No load, RSTX=3.3V, MUTEX=3.3V
Open-drain terminal Low level voltage	VERR	-	-	0.8	V	Pin22, I _o =0.5mA
Regulator output voltage 1	VREGG	4.7	5.0	5.3	V	Pin6
Regulator output voltage 2	VREG3	3	3.3	3.6	V	Pin7
High level input voltage	VIH	2	-	3.3	V	Pin 1 to 5, 19, 21, 32
Low level input voltage	VIL	0	-	0.9	V	Pin 1 to 5, 19 to 21, 32
Input current (Input pull-down terminal)	IIH	50	66	95	μA	Pin 1 to 5, 19 to 21, 32, VIN = 3.3V
Speaker Output						
Maximum output power 1	PO1	-	15	-	W	Vcc=16V, THD+n=10%, PLIMT0=L, PLIMT1=L ※6
Maximum output power 2	PO2	10	-	-	W	Vcc=16V, THD+n=10%, PLIMT0=H, PLIMT1=L ※6
Maximum output power 3	PO3	5	-	-	W	Vcc=16V, THD+n=10%, PLIMT0=H, PLIMT1=H ※6
Voltage gain1	GV26	25	26	27	dB	P _o =1W, PLIMT0=L, PLIMT1=L ※6
Voltage gain2	GV20	19	20	21	dB	P _o =1W, PLIMT0=H, PLIMT1=L ※6
Voltage gain3	GV17	16	17	18	dB	P _o =1W, PLIMT0=H, PLIMT1=H ※6
Total harmonic distortion1	THD1	-	0.16	-	%	P _o =1W, BW=20 to 20kHz (AES17) PLIMT0=H, PLIMT1=L ※6
Total harmonic distortion2	THD2	-	0.08	-	%	P _o =4.5W, BW=20 to 20kHz (AES17) PLIMT0=H, PLIMT1=L ※6
Total harmonic distortion3	THD3	-	0.24	0.3	%	P _o =1W, BW=20 to 20kHz (AES17) VCC=15.7V, PLIMT0=H, PLIMT1=L ※6
Crosstalk	CT	60	80	-	dB	P _o =1W, BW=IHF-A PLIMT0=H, PLIMT1=L ※6
PSRR (Sampling mode)	PSRR	-	65	-	dB	Vripple=1Vrms, f=1kHz ※6 PLIMT0=H, PLIMT1=L ※6
Output noise voltage (Sampling mode)	VNO	-	100	200	μVrms	-∞dBFS, BW=IHF-A ※6 PLIMT0=H, PLIMT1=L
PWM sampling frequency	fPWM1	-	256	-	kHz	fs=32kHz ※6
	fPWM2	-	352.8	-	kHz	fs=44.1kHz ※6
	fPWM3	-	384	-	kHz	fs=48kHz ※6

※6 These items show the typical performance of device and depend on board layout, parts, and power supply.
The standard value is in mounting device and parts on surface of ROHM's board directly.

● Typical Performance Curves (Reference) (1/8)

(Unless otherwise specified Ta=25°C, Vcc=12V, f=1kHz, RL=8Ω, RSTX=3.3V, MUTEX=3.3V, PLIMT0=L, PLIMT1=L, fs=48kHz, MCLK=256fs, Output LC filter : L=10uH, C=0.1uF)

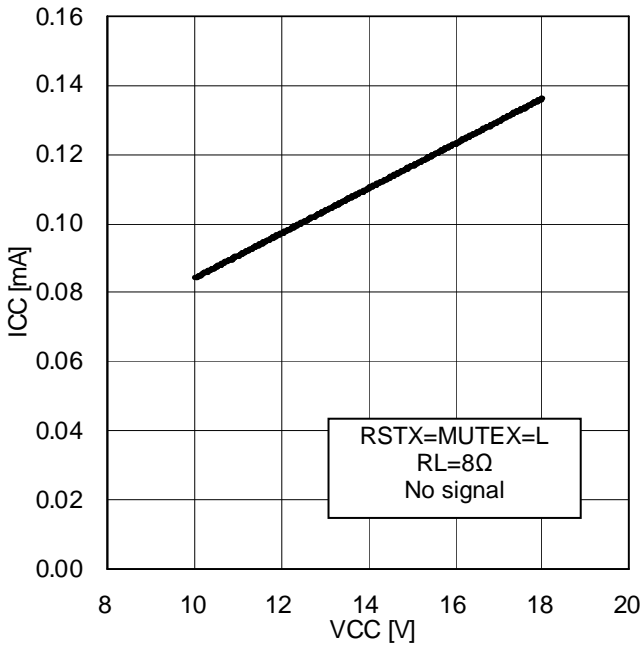

Figure 5. VCC vs. ICC

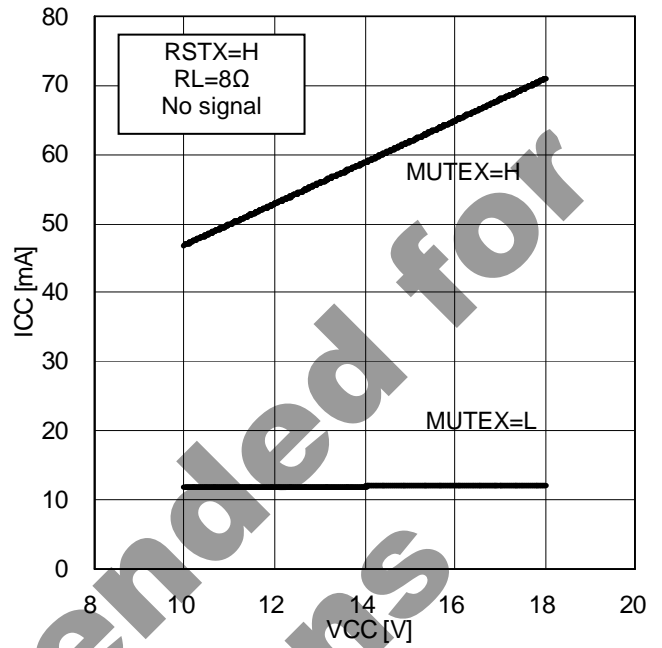

Figure 6. VCC vs. ICC

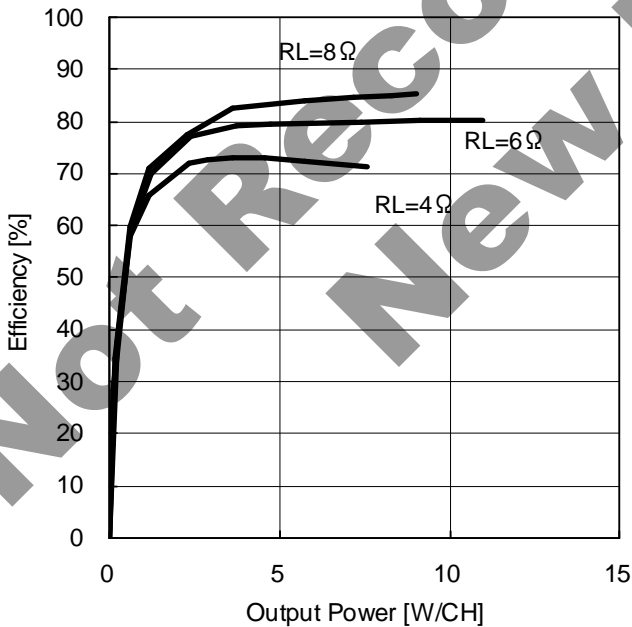

Figure 7. Output Power vs. Efficiency
PLIMT0=L, PLIMT1=L

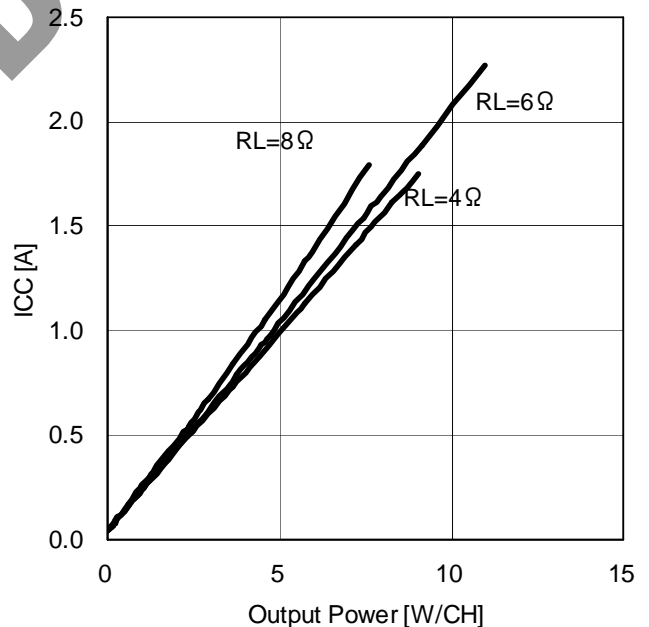

Figure 8. Output Power vs. ICC
PLIMT0=L, PLIMT1=L

● Typical Performance Curves (Reference) (2/8)

(Unless otherwise specified Ta=25°C, Vcc=12V, f=1kHz, RL=8Ω, RSTX=3.3V, MUTEX=3.3V, PLIMT0=L, PLIMT1=L, fs=48kHz, MCLK=256fs, Output LC filter : L=10uH, C=0.1uF)

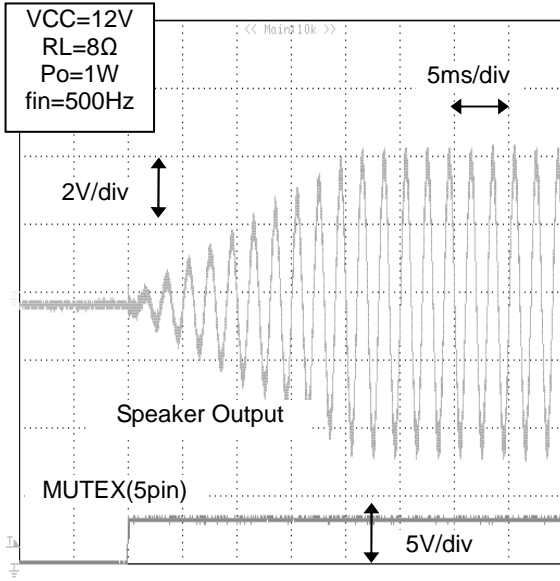

Figure 9. Waveform of Soft Start

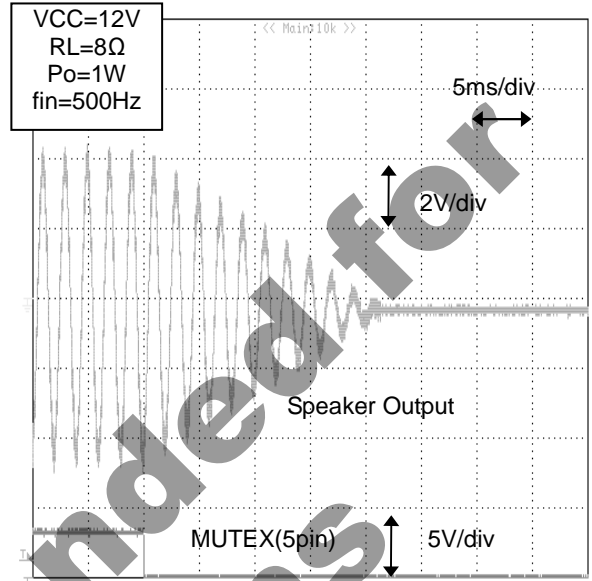

Figure 10. Waveform of Soft Mute

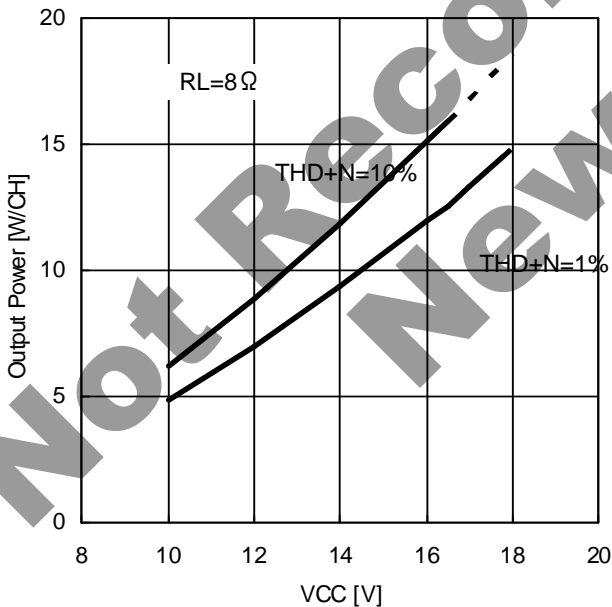

Figure 11. VCC vs. Output Power ※
PLIMT0=L, PLIMT1=L

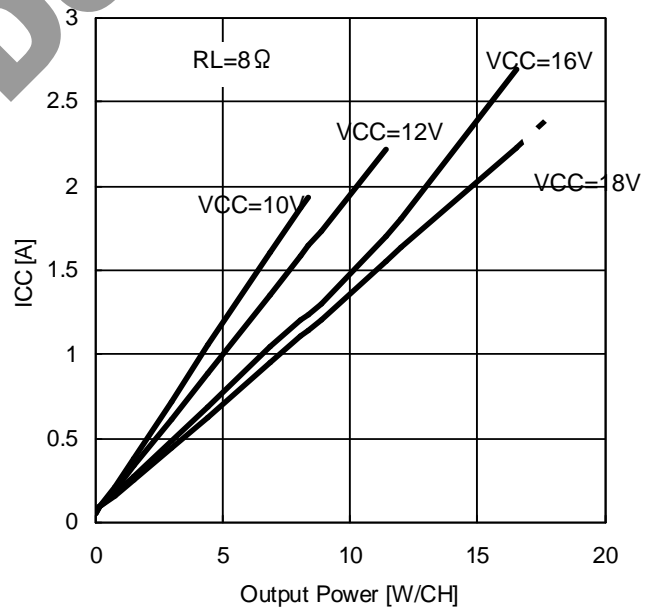

Figure 12. Output Power vs. ICC ※
PLIMT0=L, PLIMT1=L

※ Dotted line means internal dissipation is over package power.

● Typical Performance Curves (Reference) (3/8)

(Unless otherwise specified $T_a=25^{\circ}\text{C}$, $V_{CC}=12\text{V}$, $f=1\text{kHz}$, $R_L=8\Omega$, $R_{STX}=3.3\text{V}$, $MUTEX=3.3\text{V}$, $PLIMIT0=L$, $PLIMIT1=L$, $f_s=48\text{kHz}$, $MCLK=256\text{fs}$, Output LC filter : $L=10\mu\text{H}$, $C=0.1\mu\text{F}$)

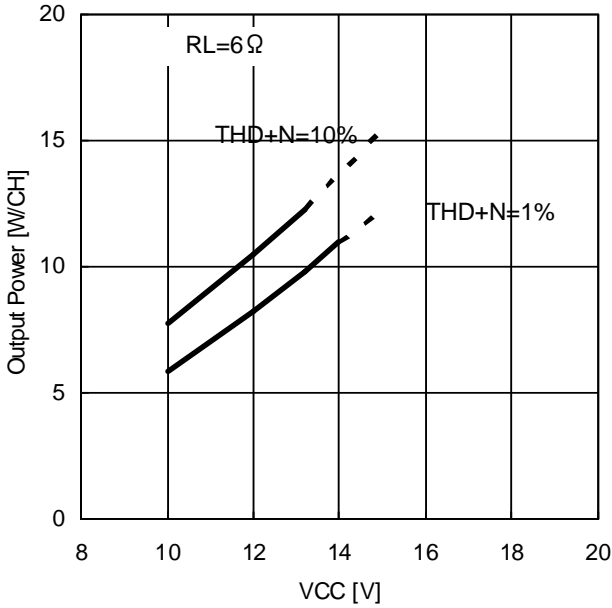

Figure 13. VCC vs. Output Power ※
PLIMIT0=L, PLIMIT1=L

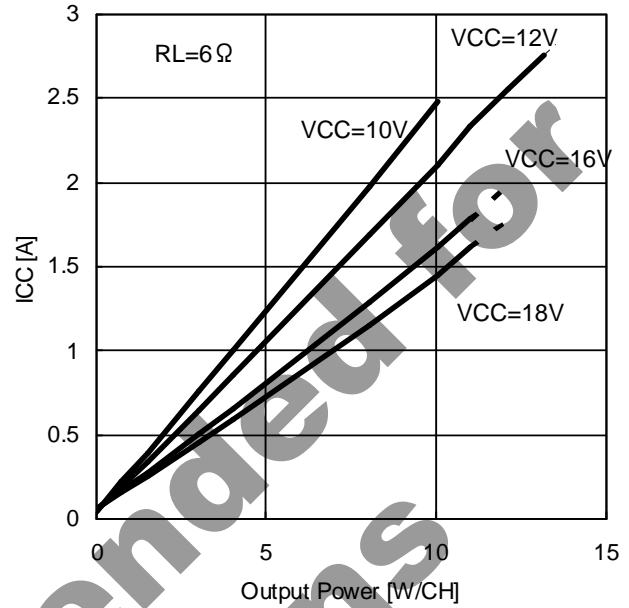

Figure 14. Output Power vs. ICC ※
PLIMIT0=L, PLIMIT1=L

※ Dotted line means internal dissipation is over package power.

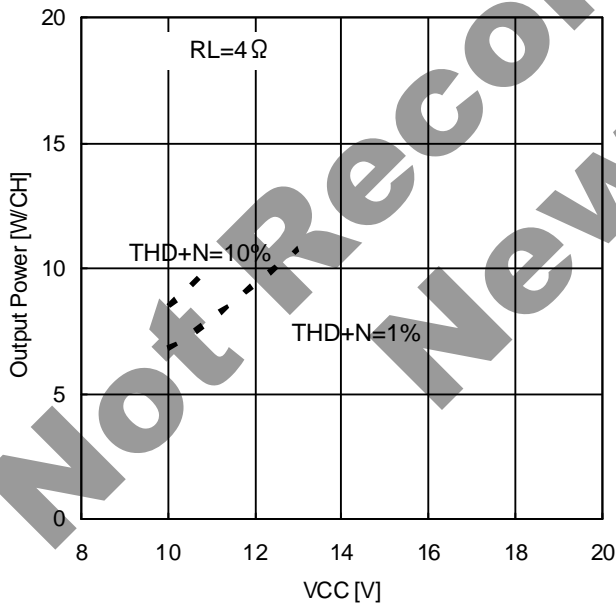

Figure 15. VCC vs. Output Power ※
PLIMIT0=L, PLIMIT1=L

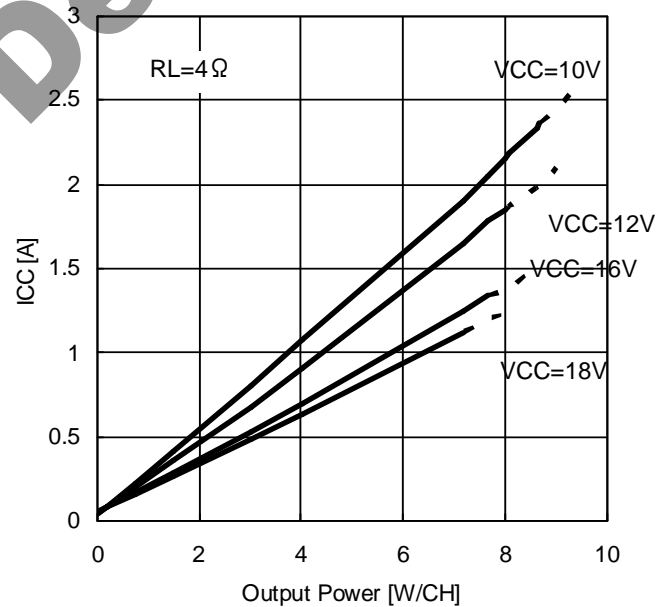

Figure 16. Output Power vs. ICC ※
PLIMIT0=L, PLIMIT1=L

※ Dotted line means internal dissipation is over package power.

● Typical Performance Curves (Reference) (4/8)

(Unless otherwise specified Ta=25°C, Vcc=12V, f=1kHz, RL=8Ω, RSTX=3.3V, MUTEX=3.3V, PLIMIT0=L, PLIMIT1=L, fs=48kHz, MCLK=256fs, Output LC filter : L=10uH, C=0.1uF)

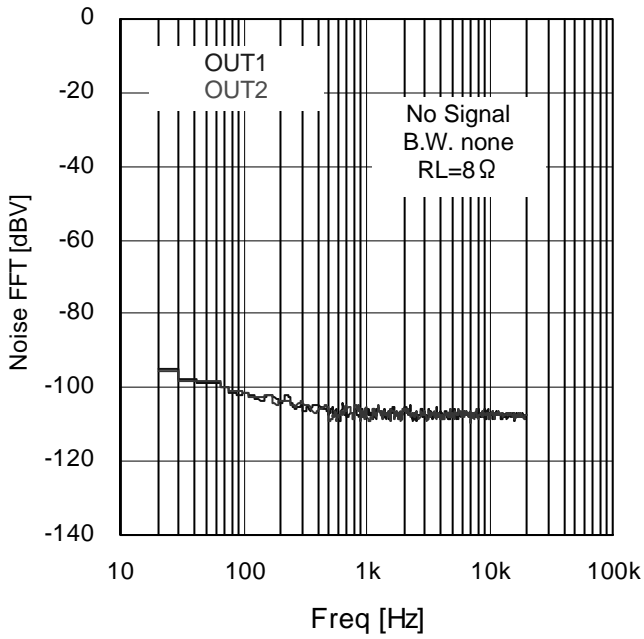

Figure 17. FFT of output noise voltage

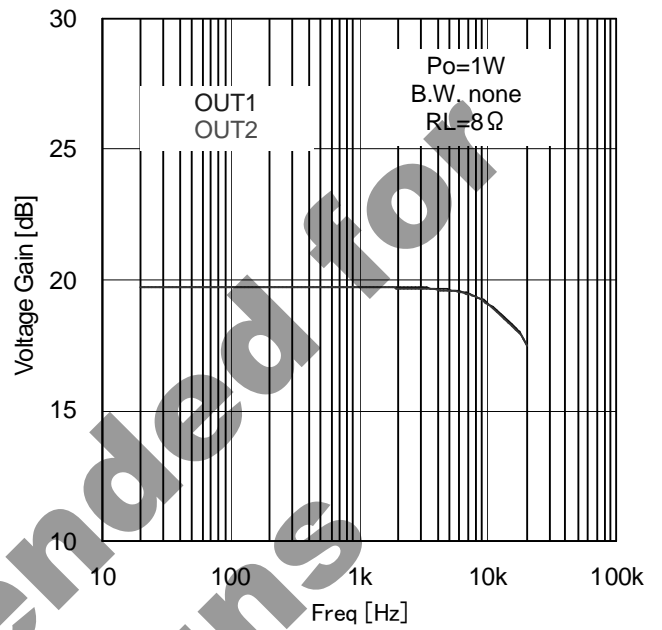

Figure 18. Freq vs. Voltage Gain

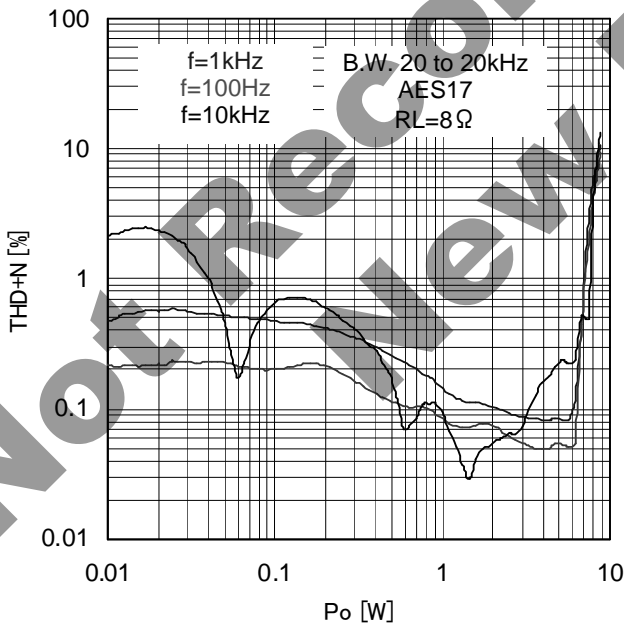

Figure 19. Po vs. THD+N

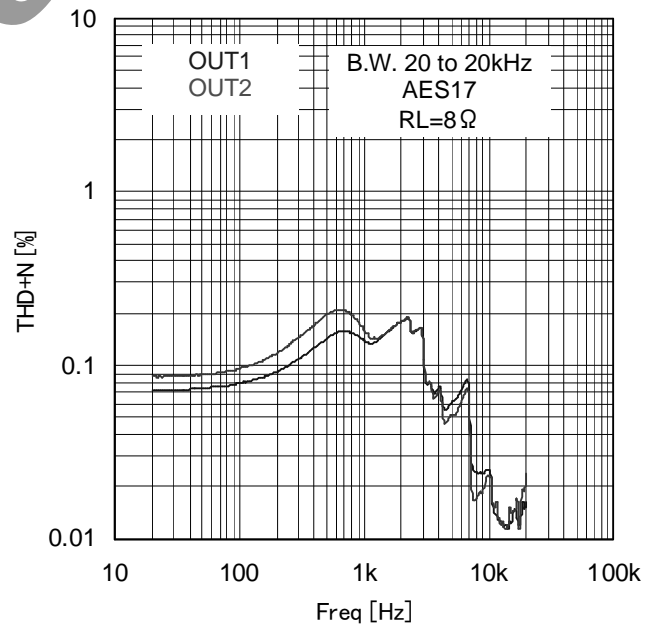

Figure 20. Freq vs. THD+N

● Typical Performance Curves (Reference) (5/8)

(Unless otherwise specified Ta=25°C, Vcc=12V, f=1kHz, RL=8Ω, RSTX=3.3V, MUTEX=3.3V, PLIMIT0=L, PLIMIT1=L, fs=48kHz, MCLK=256fs, Output LC filter : L=10uH, C=0.1uF)

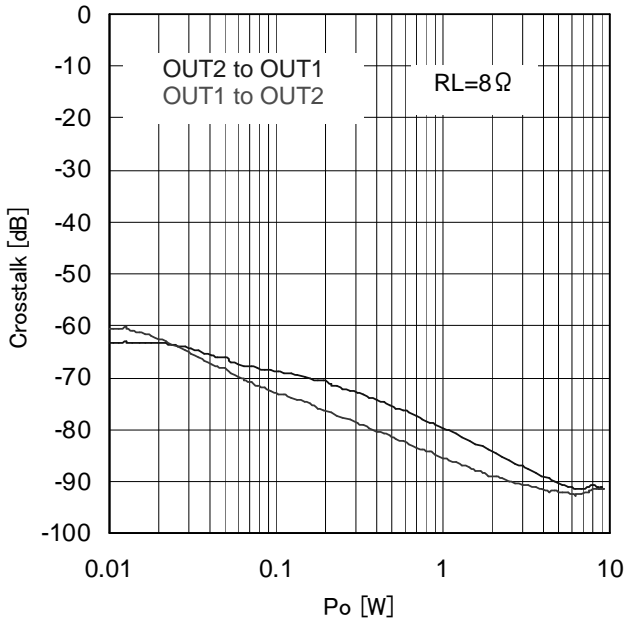

Figure 21. Po vs. Crosstalk

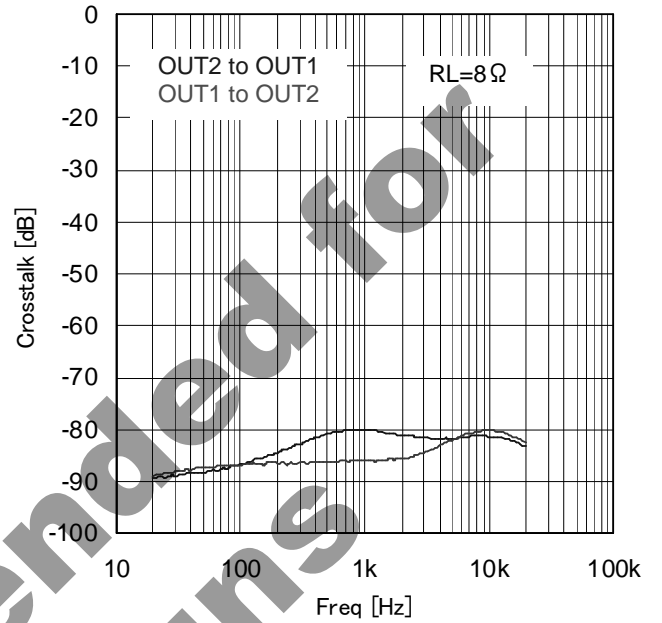

Figure 22. Freq vs. Crosstalk

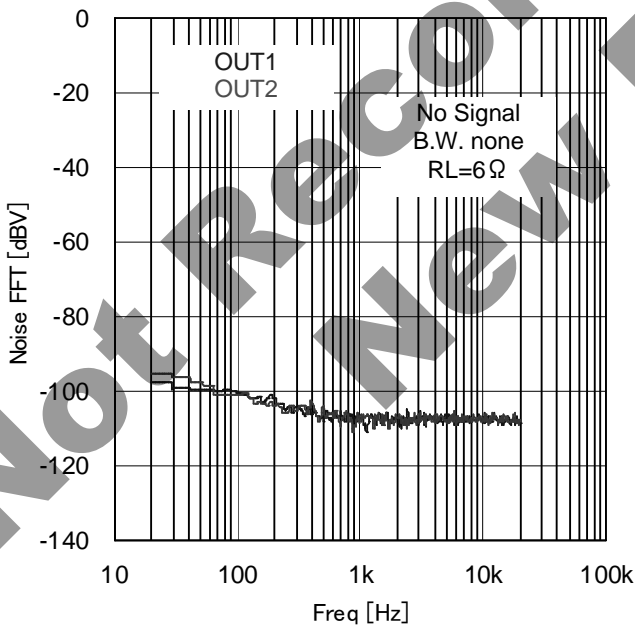

Figure 23. FFT of output noise voltage

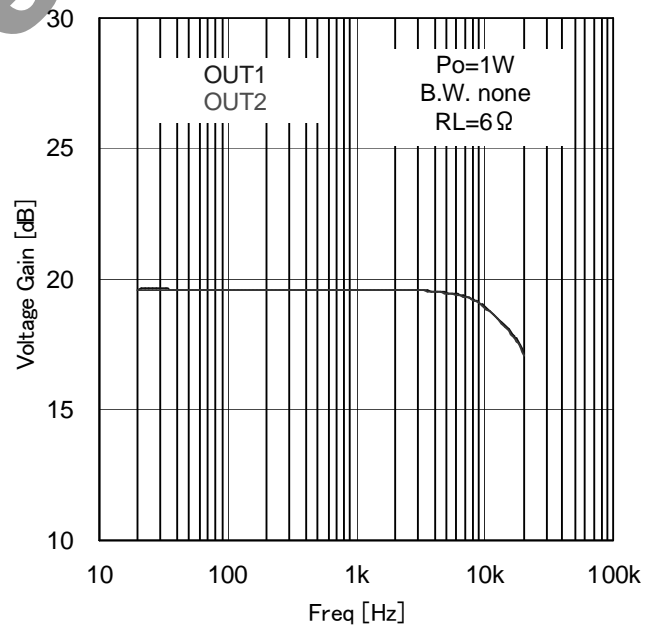

Figure 24. Freq vs. Voltage Gain

● Typical Performance Curves (Reference) (6/8)

(Unless otherwise specified Ta=25°C, Vcc=12V, f=1kHz, RL=8Ω, RSTX=3.3V, MUTEX=3.3V, PLIMIT0=L, PLIMIT1=L, fs=48kHz, MCLK=256fs, Output LC filter : L=10uH, C=0.1uF)

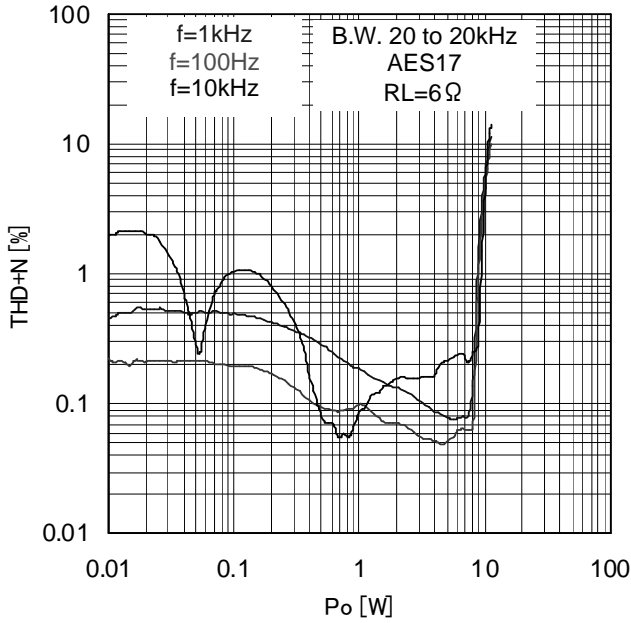

Figure 25. Po vs. THD+N

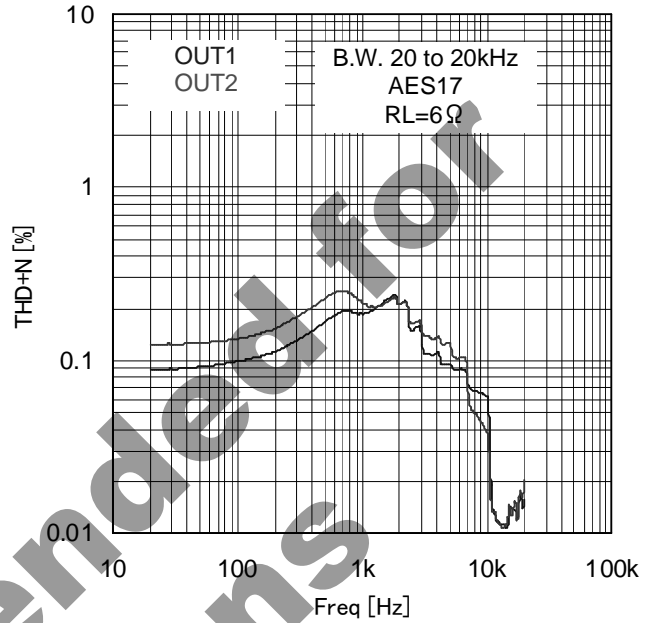

Figure 26. Freq vs. THD+N

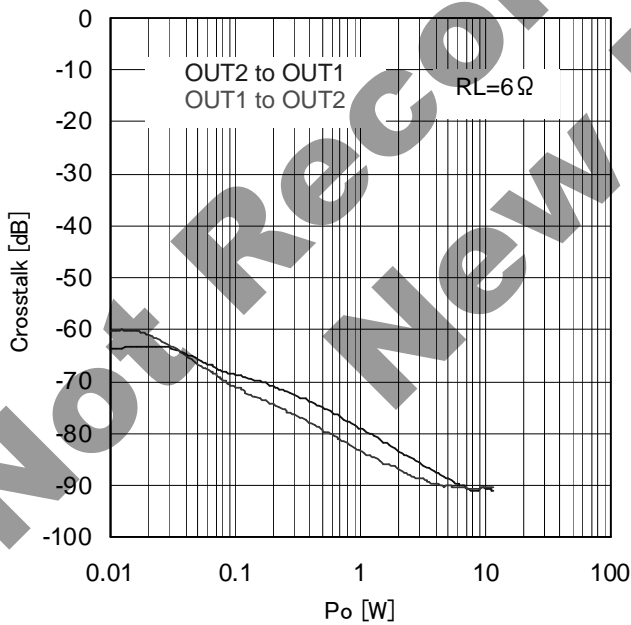

Figure 27. Po vs. Crosstalk

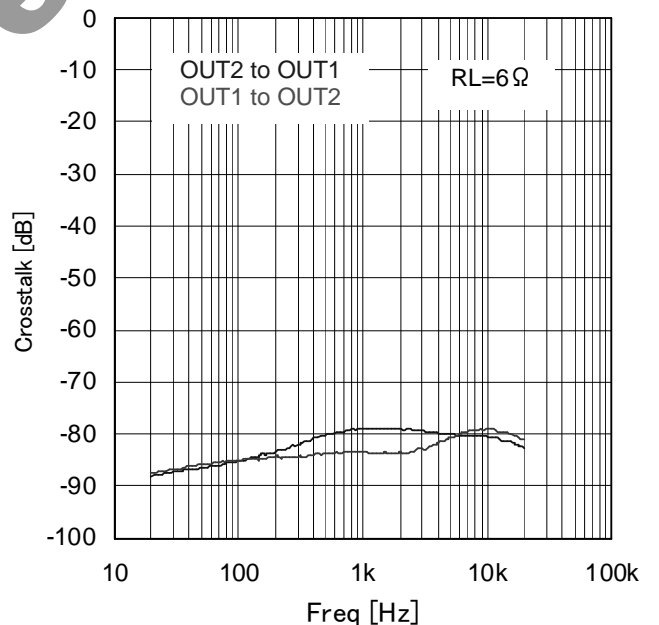

Figure 28. Freq vs. Crosstalk

● Typical Performance Curves (Reference) (7/8)

(Unless otherwise specified Ta=25°C, Vcc=12V, f=1kHz, RL=8Ω, RSTX=3.3V, MUTEX=3.3V, PLIMIT0=L, PLIMIT1=L, fs=48kHz, MCLK=256fs, Output LC filter : L=10uH, C=0.1uF)

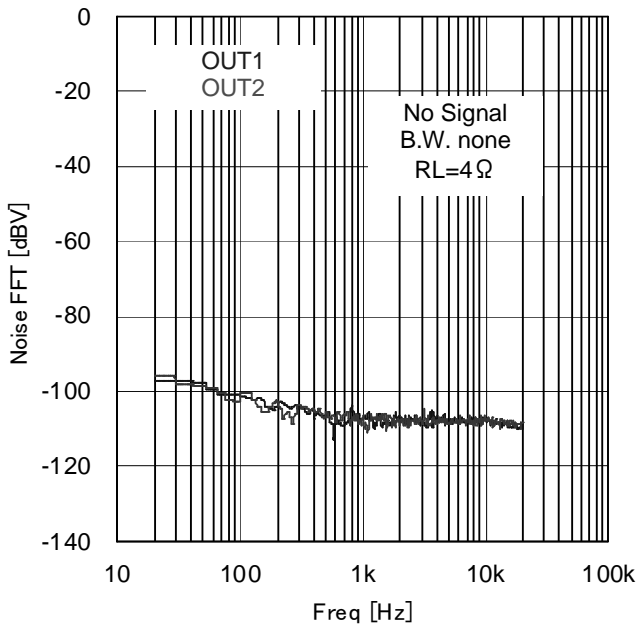

Figure 29. FFT of output noise voltage

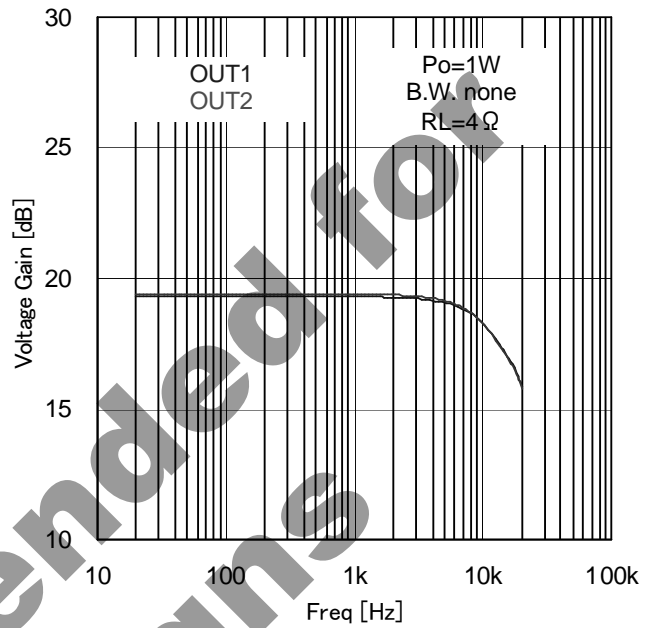

Figure 30. Freq vs. Voltage Gain

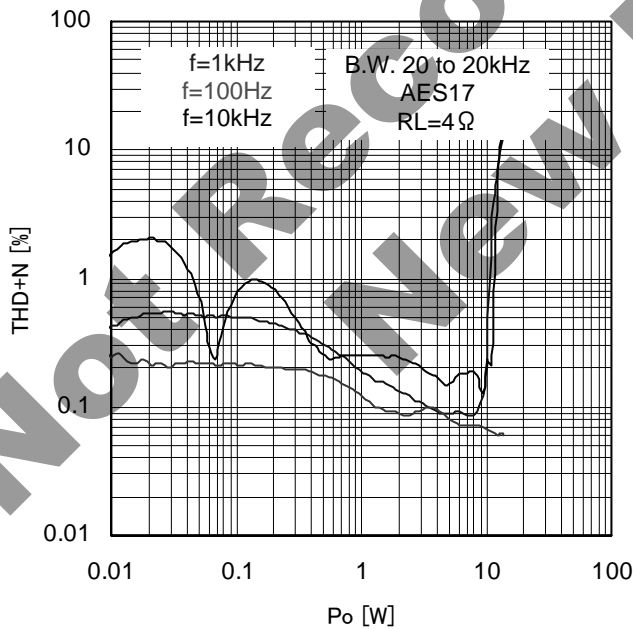

Figure 31. Po vs. THD+N

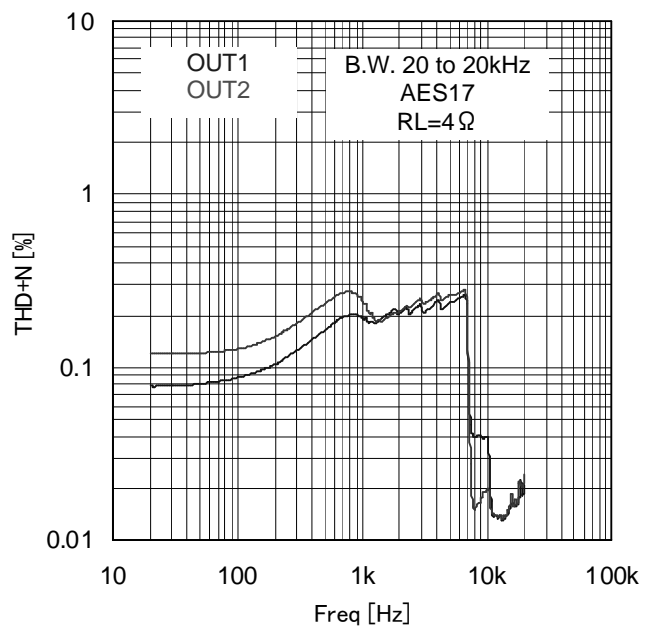

Figure 32. Freq vs. THD+N

● Typical Performance Curves (Reference) (8/8)

(Unless otherwise specified $T_a=25^{\circ}\text{C}$, $V_{cc}=12\text{V}$, $f=1\text{kHz}$, $R_L=8\Omega$, $R_{STX}=3.3\text{V}$, $MUTEX=3.3\text{V}$, $PLIMIT0=L$, $PLIMIT1=L$, $f_s=48\text{kHz}$, $MCLK=256\text{fs}$, Output LC filter : $L=10\mu\text{H}$, $C=0.1\mu\text{F}$)

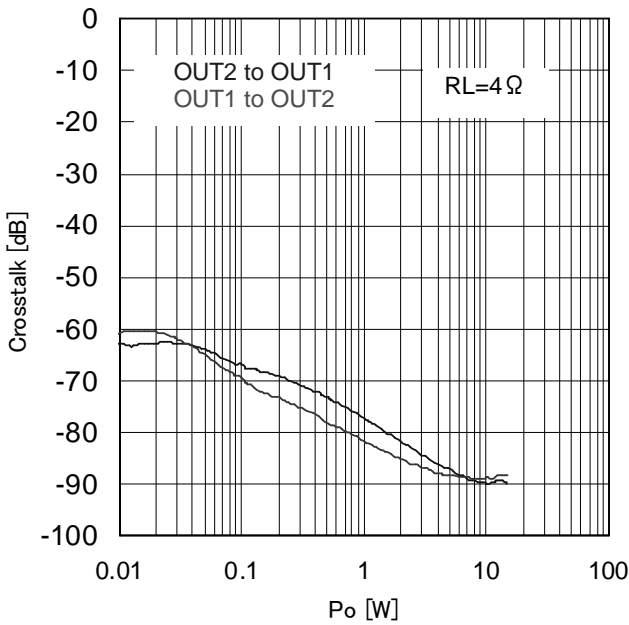

Figure 33. P_o vs. Crosstalk

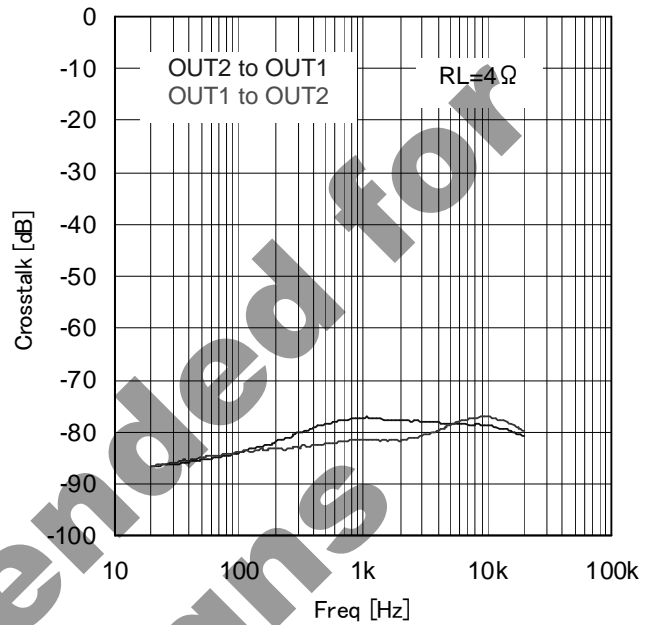

Figure 34. Freq vs. Crosstalk

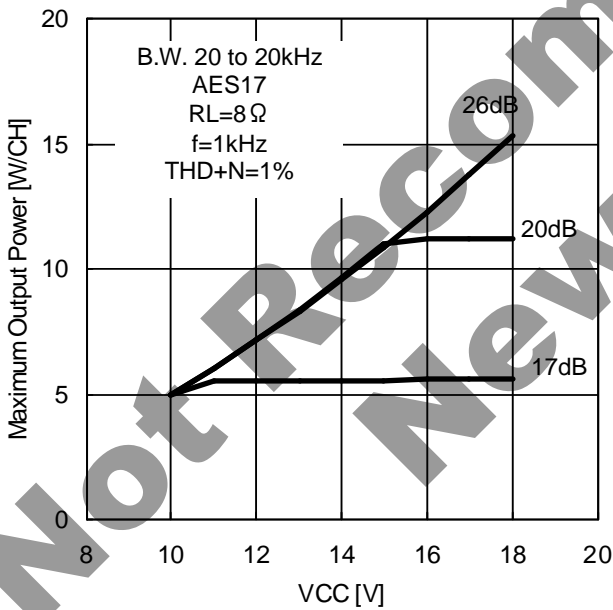

Figure 35. V_{CC} vs. Maximum Output Power

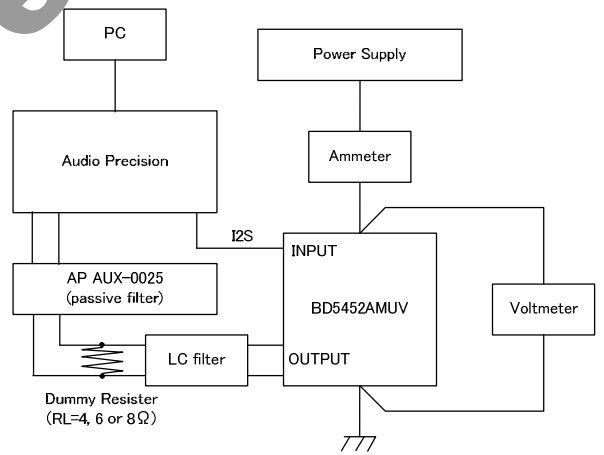

Figure 36. Audio Characteristics Measurement Environment

●About digital audio input

1) Input digital audio signal sampling frequency (fs) explanation

PWM sampling frequency, Soft-start, Soft-mute time, and the detection time of the DC voltage protection in the speaker depends on sampling frequency (fs) of the digital audio input.

Sampling frequency of the digital audio input (fs)	PWM sampling frequency (fpwm)	Soft-start / Soft-mute time	DC voltage protection in the speaker detection time
32kHz	256kHz	32msec.	1.02sec
44.1kHz	352.8kHz	23msec.	0.74sec
48kHz	384kHz	21.5msec.	0.68sec

2) Format of digital audio input

MCLK: It is System Clock input signal.

It will input LRCLK, BCLK, SDATA that synchronizes with this clock that are 256 times of sampling frequency (256fs) or 512 times of sampling frequency (512fs).

LRCLK: It is L/R clock input signal.

It corresponds to 32kHz/44.1kHz/48kHz with that clock(fs) which are same to the sampling frequency (fs). The data of a left channel and a right channel for one sample is input to this section

BCLK: It is Bit Clock input signal.

It is used for the latch of data in every one bit by sampling frequency's 64 times sampling frequency (64fs).

SDATA: It is Data input signal.

It is amplitude data. The data length is different according to the resolution of the input digital audio data. It corresponds to 16/ 20/ 24 bit.

3) I2S data format

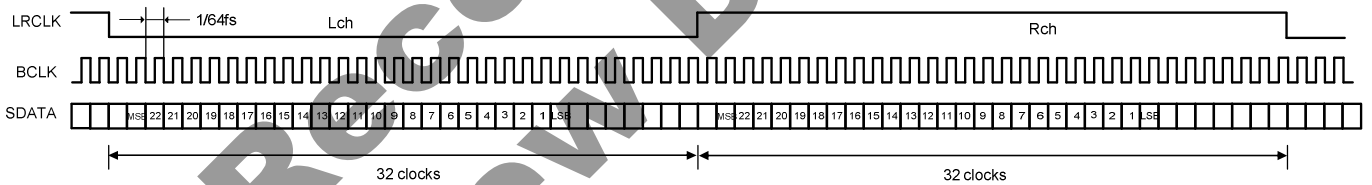

Figure 37. I2S Data Format 64fs, 24bit Data

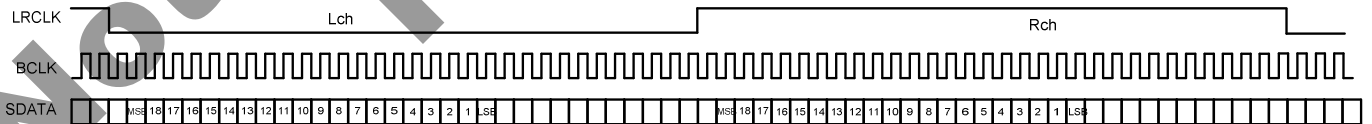

Figure 38. I2S Data Format 64fs, 20bit Data

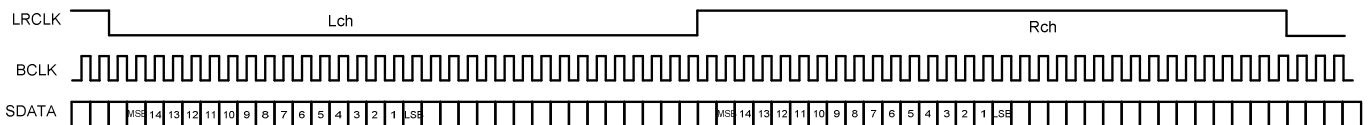

Figure 39. I2S Data Format 64fs, 16bit Data

The Low section of LRCLK becomes Lch, the High section of LRCLK becomes Rch.

After changing LRCLK, second bit becomes MSB.

4) Audio Interface format and timing

Recommended timing and operating conditions(MCLK, BCLK, LRCLK and SDATA)

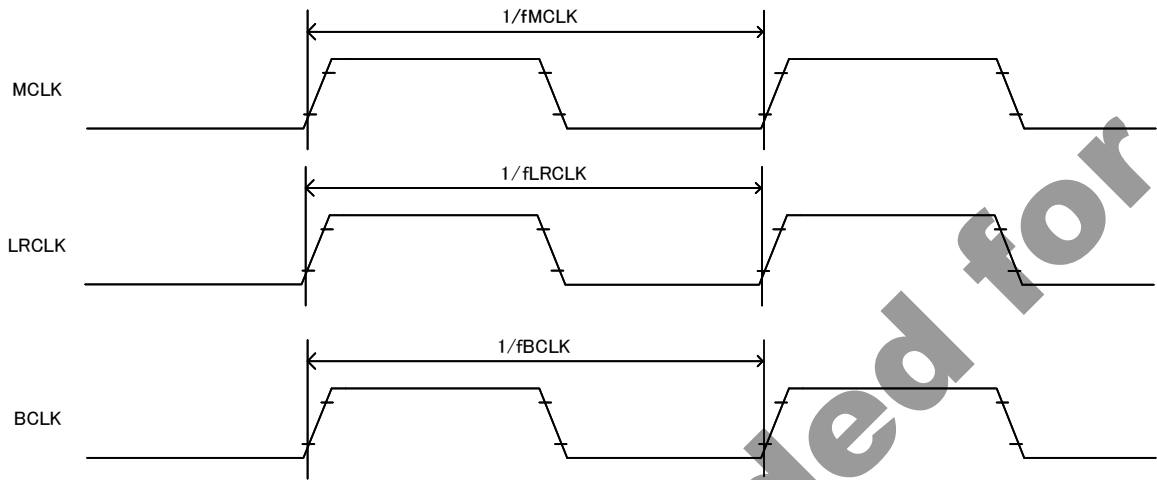

Figure 40. Clock timing

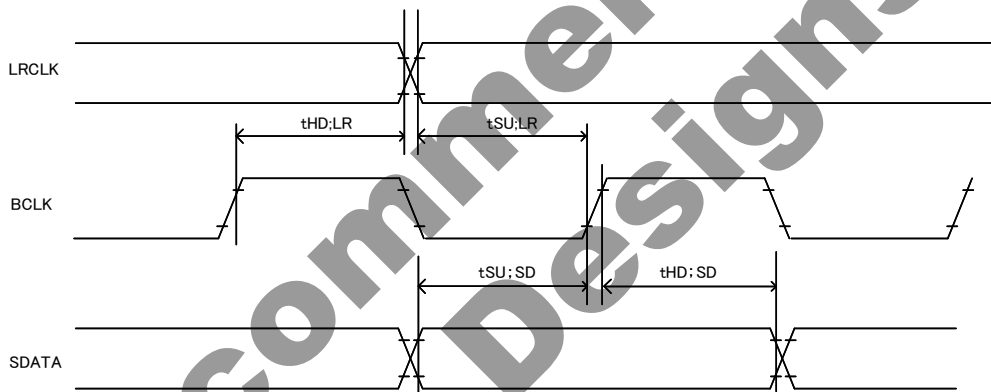

Figure 41. Audio Interface timing

No.	Parameter	Symbol	Limit				Unit
			MCLK=256fs		MCLK=512fs		
			Min.	Max.	Min.	Max.	
1	MCLK frequency	fMCLK	8.192	12.288	16.384	24.576	MHz
2	LRCLK frequency	fLRCLK	32	48	32	48	kHz
3	BCLK frequency	fBCLK	2.048	3.072	2.048	3.072	MHz
4	Setup time, LRCLK※7	tSU;LR	20	—	20	—	ns
5	Hold time, LRCLK※7	tHD;LR	20	—	20	—	ns
6	Setup time, SDATA	tSU;SD	20	—	20	—	ns
7	Hold time, SDATA	tHD;SD	20	—	20	—	ns
8	MCLK, DUTY	dMCLK	40	60	40	60	%
9	LRCLK, DUTY	dLRCLK	40	60	40	60	%
10	BCLK, DUTY	dBCLK	40	60	40	60	%

※7 This regulation is to keep rising edge of LRCK and rising edge of BCLK from overlapping.

●Timing Chart

1) Power supply start-up sequence

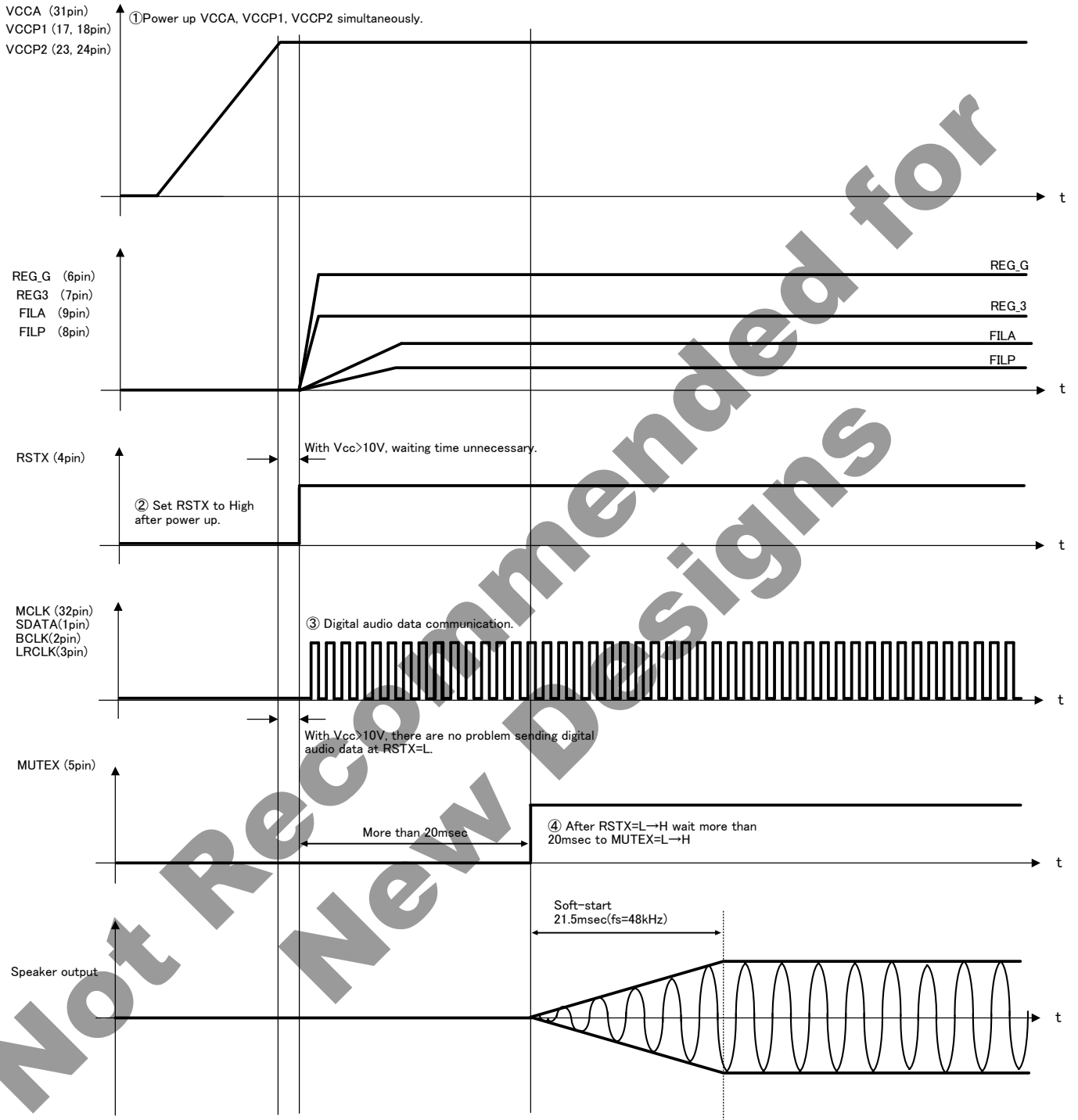

Figure 42. Power supply start-up sequence

2) Power supply shut-down sequence

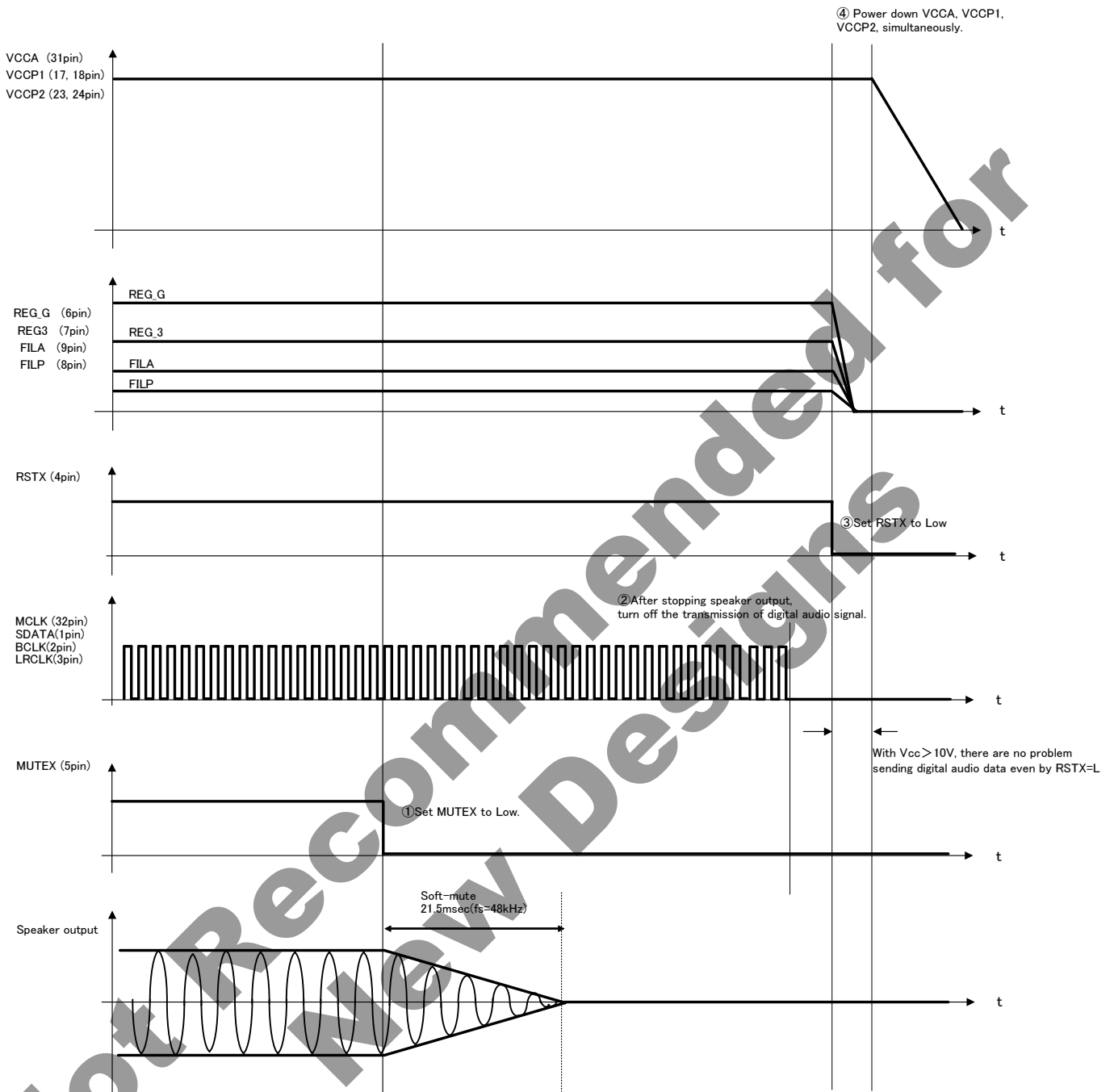

Figure 43. Power supply shut-down sequence

3) About changing audio signal

The output PWM frequency of BD5452AMUV becomes the frequency of eight times of the sampling frequency f_s . Therefore output PWM frequency becomes unstable when MCLK seems to become unstable at the time of channel switching at input switching and so on. It is possible that the LC resonance is occurred and a short protections function worked.

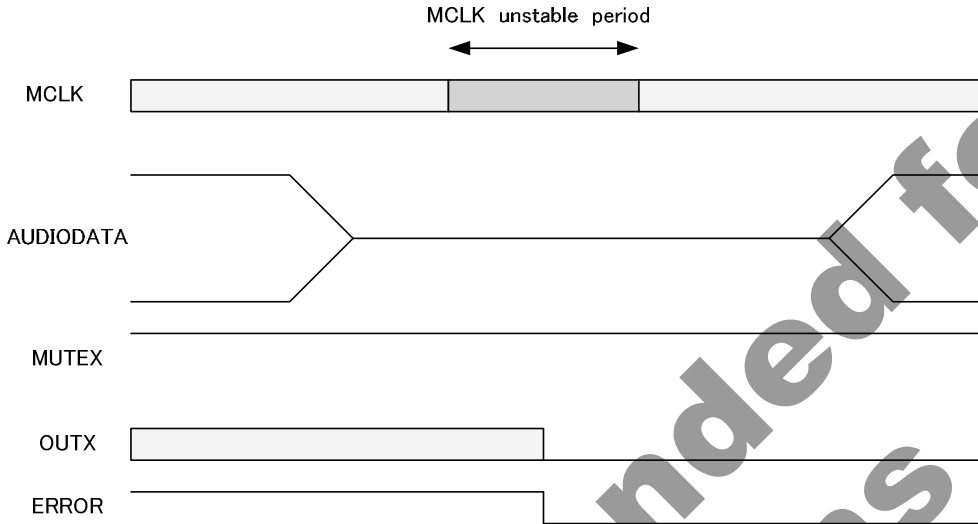

Figure 44. Action at MCLK unstable1

If you can expect MCLK unstable period, we suggest following process.

1. Mute AUDIODATA from scalar IC.(A)
2. After muting AUDIODATA from scalar IC (B), set MUTEX=L(C).
3. After MCLK go to stable state, set MUTEX=H(D).
4. Release mute AUDIODARA from scalar IC(E).

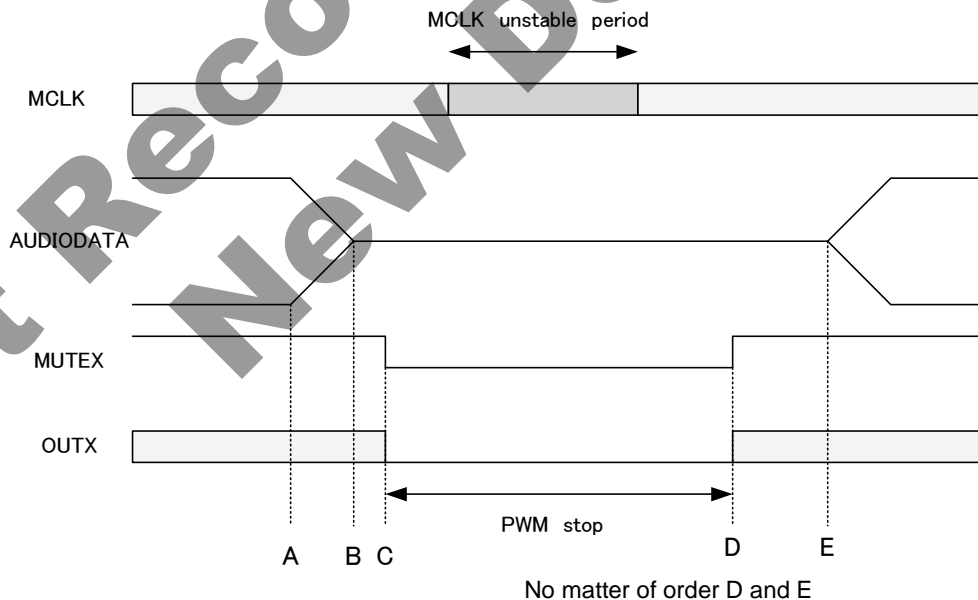

Figure 45. Action at MCLK unstable2

●About the protection function

Protection function	Detecting & Releasing condition		PWM Output	ERROR Output
Output short protection	Detecting condition	Detecting current = 10A (TYP.)	HiZ_Low (Latch)	L (Latch)
DC voltage protection in the speaker	Detecting condition	At speaker output, impressed DC voltage over 0.68sec (fs=48kHz) over 3.5V(between (power limit off), 1.75V(power limit 10W) or 1.225V(power limit 5W)	HiZ_Low (Latch)	L (Latch)
High temperature protection	Detecting condition	Chip temperature to be above 150°C (TYP.)	HiZ_Low	L
	Releasing condition	Chip temperature to be below 120°C (TYP.)	Normal operation	
Under voltage protection	Detecting condition	Power supply voltage to be below 8V (TYP.)	HiZ_Low	H
	Releasing condition	Power supply voltage to be above 9V (TYP.)	Normal operation	
Over voltage Protection	Detecting condition	Power supply voltage to be above 20V(TYP.)	HiZ_Low	H
	Releasing condition	Power supply voltage to be below 19.5V(TYP.)	Normal operation	
Clock stop protection	Detecting condition	No change to MCLK more than 1usec (TYP.) or no change to BCLK more than 1usec (TYP.) or no change to LRCLK more than 21usec (at fs=48kHz.).	HiZ_Low	H
	Releasing condition	Normal input to MCLK, BCLK and LRCLK.	Normal operation	

* The ERROR pin is Nch open-drain output.

* Once an IC is latched, the circuit is not released automatically even after an abnormal status is removed. The following procedures ① or ② is available for recovery.

①After turning MUTEX terminal to Low(holding time to Low = 10msec(Min.)) turn back to High again.

②Restore power supply after dropping to power supply voltage $V_{cc} < 3V$ (10msec (Min.) holding) which internal power on reset circuit activates.

1) Output short protection (Short to the power supply)

This IC has the PWM output short protection circuit that stops the PWM output when the PWM output is short-circuited to the power supply due to abnormality.

Detecting condition - It will detect when MUTEX pin is set High and the current that flows in the PWM output pin becomes 10A(TYP.) or more. The PWM output instantaneously enters the state of HiZ-Low if detected, and IC does the latch.

Releasing method - ①After turning MUTEX terminal to Low(holding time to Low = 10msec(Min.)) turn back to High again.
 ②Restore power supply after dropping to power supply voltage $V_{cc} < 3V(10msec (Min.))$ holding) which internal power on reset circuit activates.

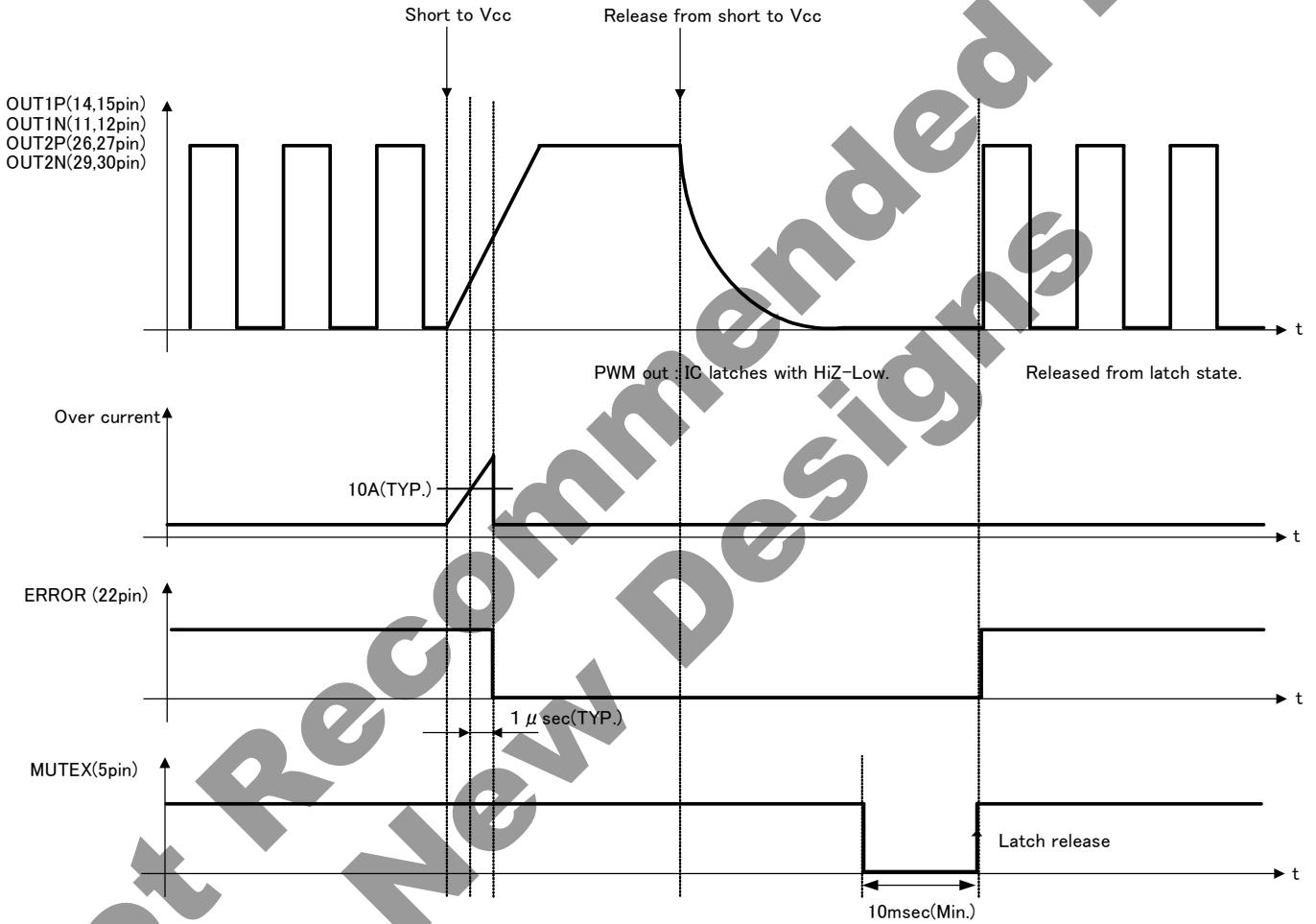

Figure 46. Sequence of the Output short protection

2) Output short protection (Short to GND)

This IC has the PWM output short protection circuit that stops the PWM output when the PWM output is short-circuited to GND due to abnormality.

Detecting condition - It will detect when MUTEX pin is set High and the current that flows in the PWM output terminal becomes 10A(TYP.) or more. The PWM output instantaneously enters the state of HiZ-Low if detected, and IC does the latch.

Releasing method - ① After turning MUTEX terminal to Low(holding time to Low = 10msec(Min.)) turn back to High again.
② Restore power supply after dropping to power supply voltage $V_{CC} < 3V$ (10msec (Min.) holding) which internal power on reset circuit activates.

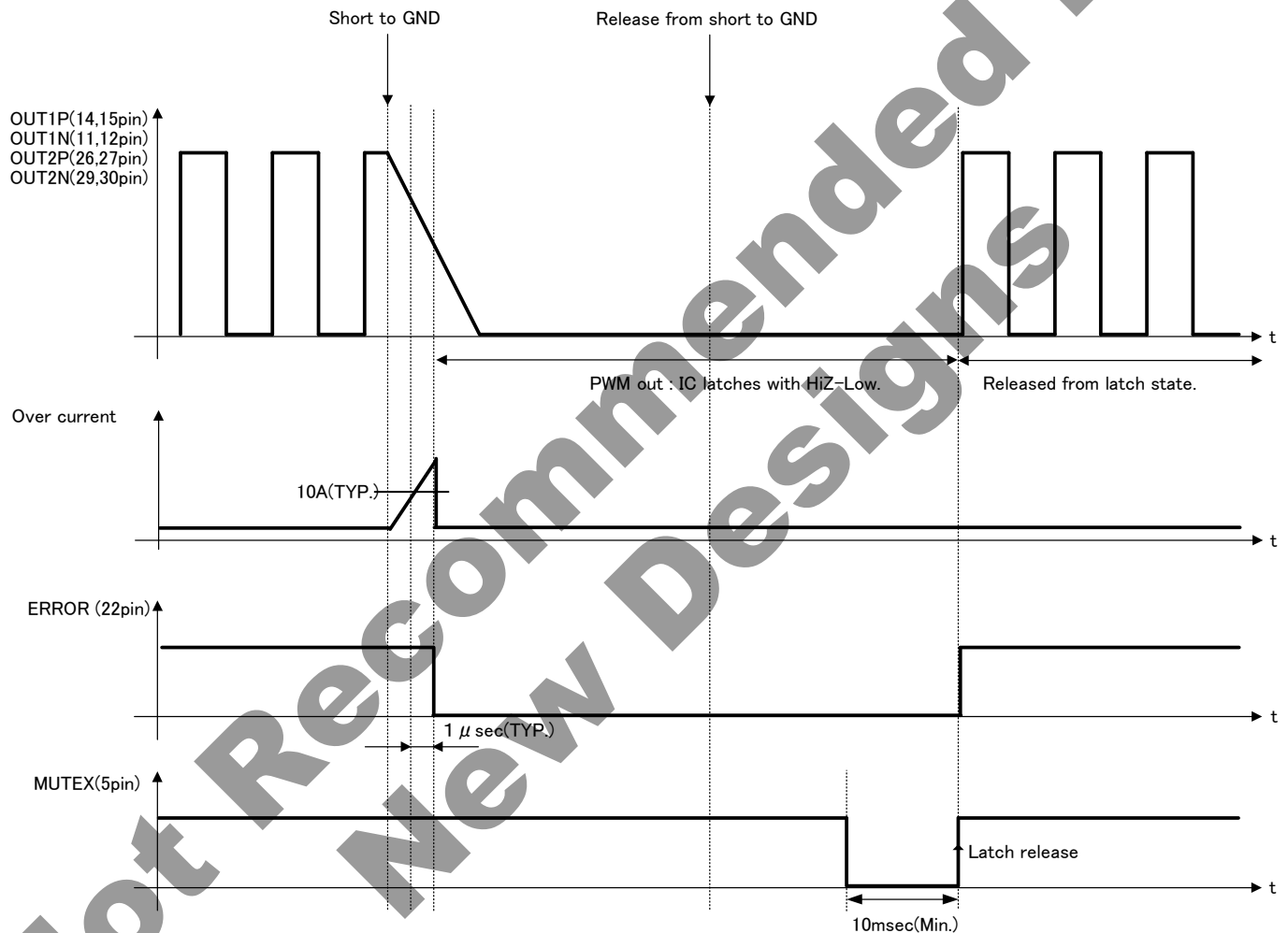

Figure 47. Sequence of the Output short protection

3) DC voltage protection in the speaker1

When the DC voltage in the speaker is impressed due to abnormality, this IC has the protection circuit where the speaker is defended from destruction.

Detecting condition - It will detect when MUTEX pin is set High and speaker output is more than 3.5V(TYP, Power Limit OFF setting), 1.75V(TYP, Power Limit 10W setting), 1.225V(TYP, Power Limit 5W setting), 0.68sec(fs=48kHz) or above. Once detected, The PWM output instantaneously enters the state of HiZ-Low, and IC does the latch.

Releasing method - ① After turning MUTEX terminal to Low(holding time to Low = 10msec(Min.)) turn back to High again.

② Restore power supply after dropping to power supply voltage $V_{CC} < 3V$ (10msec (Min.) holding) which internal power on reset circuit activates.

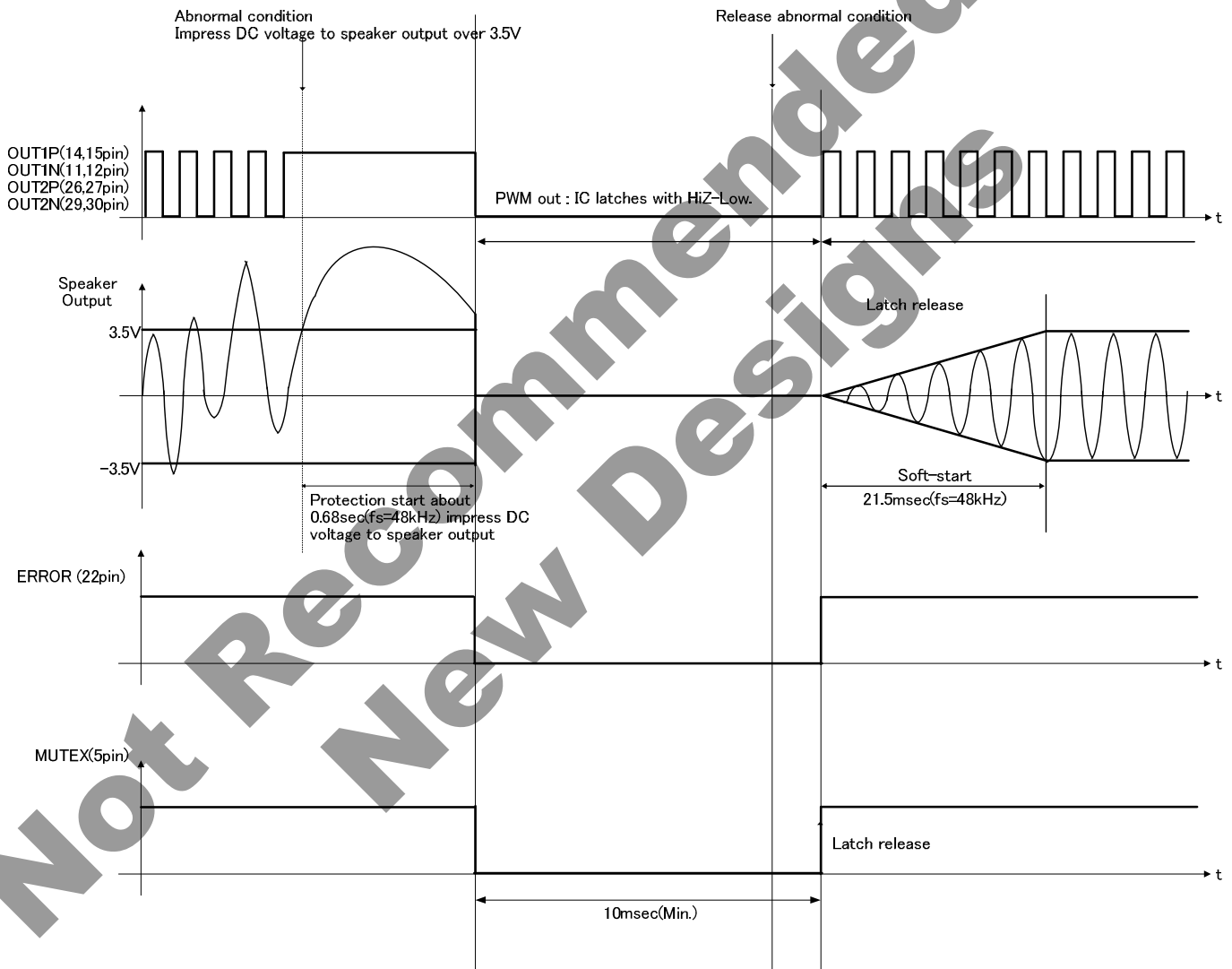

Figure 48. Sequence of DC voltage protection in the speaker1

4) DC voltage protection in the speaker2

About DC voltage protection at PWM output Duty=0% or 100%

When the DC voltage in the speaker is impressed due to abnormality, this IC has the protection circuit where the speaker is defended from destruction.

Detecting condition - It will detect when MUTEX pin is set High or Low and PWM output Duty=0% or 100% , 43msec($f_s=48\text{kHz}$) or above. Once detected, The PWM output instantaneously enters the state of HiZ-Low, and IC does the latch.

Releasing method - ①After turning MUTEX terminal to Low(holding time to Low = 10msec(Min.)) turn back to High again.

②Restore power supply after dropping to power supply voltage $V_{CC} < 3V$ (10msec (Min.) holding) which internal power on reset circuit activates.

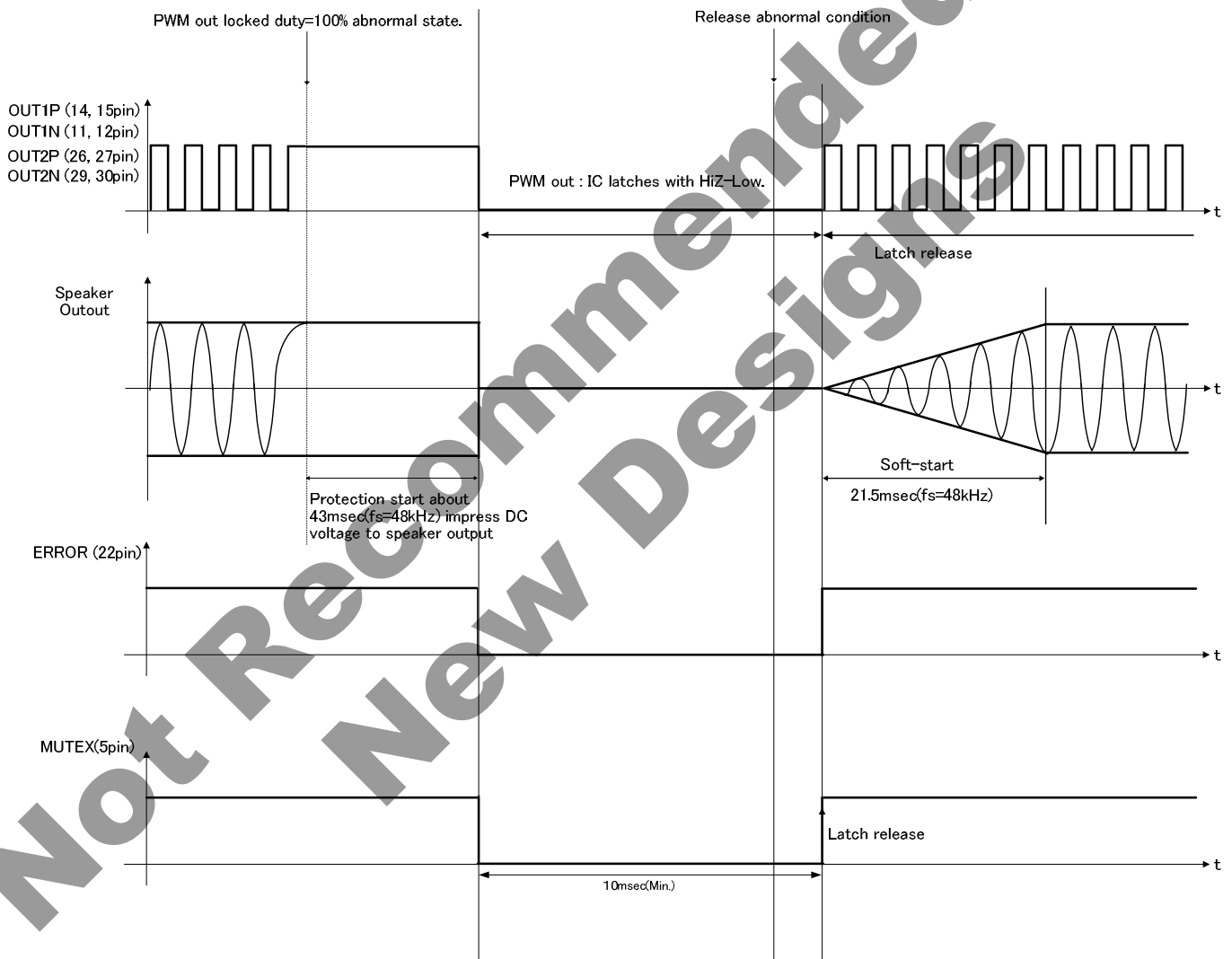

Figure 49. Sequence of DC voltage protection in the speaker2

5) High temperature protection

This IC has the high temperature protection circuit that prevents thermal reckless driving under an abnormal state for the temperature of the chip to exceed $T_{jmax}=150^{\circ}\text{C}$.

Detecting condition - It will detect when MUTEX pin is set High and the temperature of the chip becomes 150°C (TYP.) or more. Speaker output turns MUTE immediately, when High temperature protection is detected.

Releasing condition - It will release when MUTEX pin is set High and the temperature of the chip becomes 120°C (TYP.) or less. The speaker output is outputted through a soft-start when released. (Auto recovery)

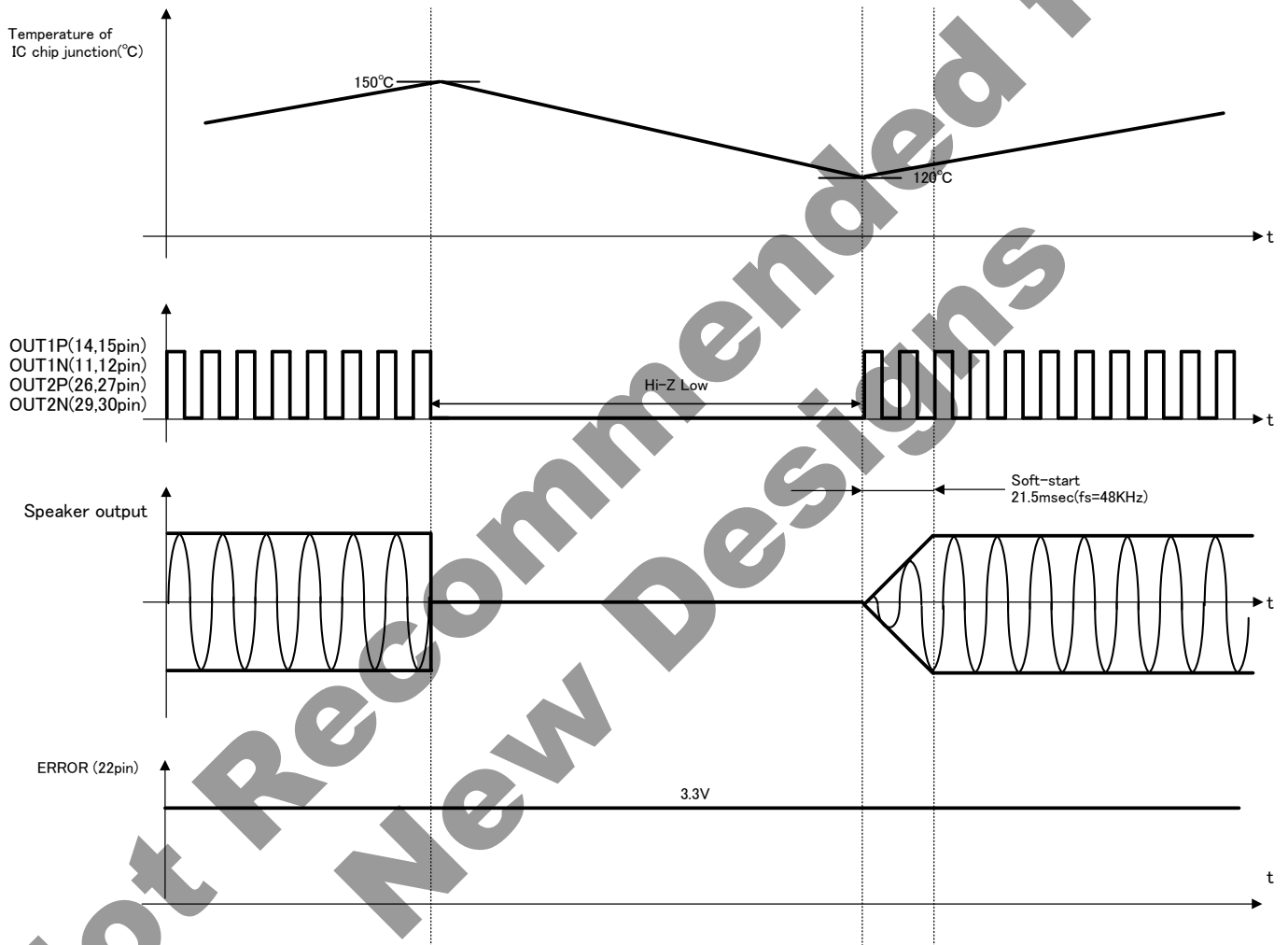

Figure 50. Sequence of High temperature protection

6) Under voltage protection

This IC has the under voltage protection circuit that make speaker output mute once detecting extreme drop of the power supply voltage.

Detecting condition - It will detect when MUTEX pin is set High and the power supply voltage becomes lower than 8V(TYP.).Speaker output turn MUTE immediately, when Under voltage protection is detected.

Releasing condition - It will release when MUTEX pin is set High and the power supply voltage becomes more than 9V(TYP.). The speaker output is outputted through a soft-start when released. (Auto recovery)

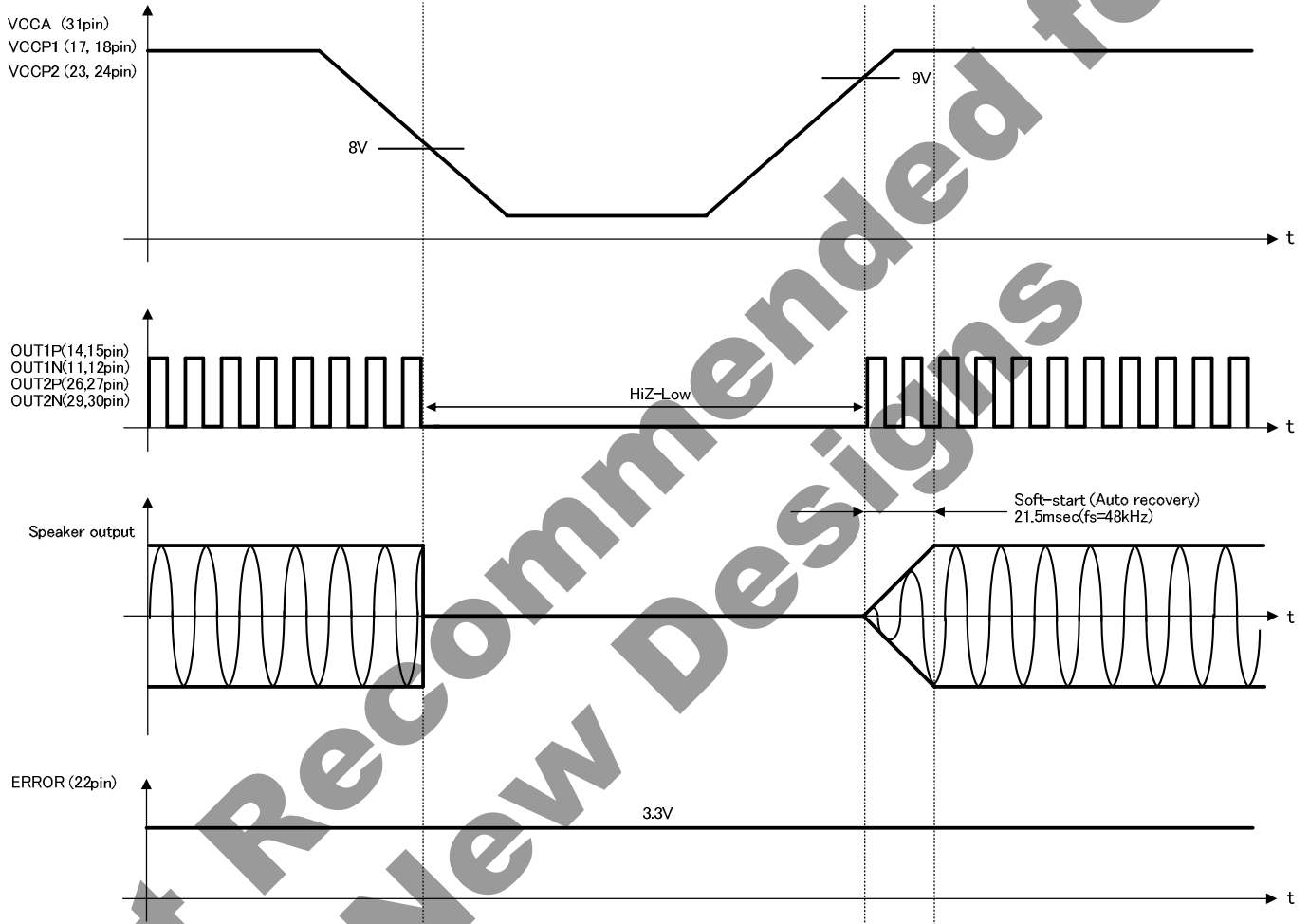

Figure 51. Sequence of Under voltage protection

7) Over voltage protection

This IC has the under voltage protection circuit that make speaker output mute once detecting extreme drop of the power supply voltage.

Detecting condition - It will detect when MUTEX pin is set High and the power supply voltage becomes more than 20V(TYP.).Speaker output turn MUTE immediately, when over voltage protection is detected.

Releasing condition - It will release when MUTEX pin is set High and the power supply voltage becomes lower than 19.5V(TYP.). The speaker output is outputted through a soft-start when released. (Auto recovery)

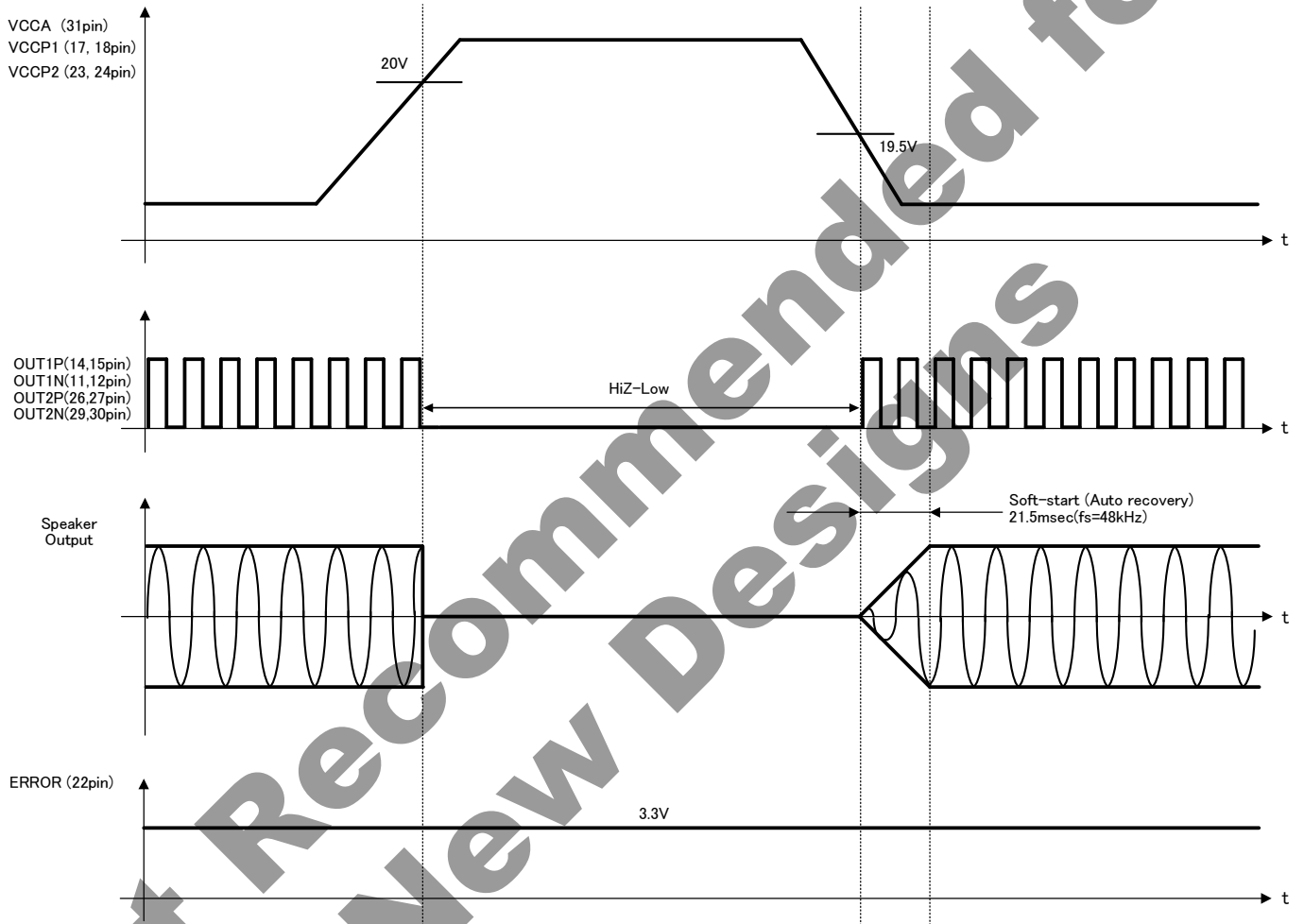

Figure 52. Sequence of Over voltage protection

8) Clock stop protection(MCLK)

This IC has the clock stop protection circuit that make the speaker output mute when the MCLK signal of the digital audio input stops.

Detecting condition - It will detect when MUTE pin is set High and the MCLK signal stops for about 1usec or more. Speaker output turn MUTE immediately, clock stop protection is detected.

Releasing condition - It will release when MUTE pin is set High and the MCLK signal returns to the normal clock operation. The speaker output is outputted through a soft-start when released. (Auto recovery)

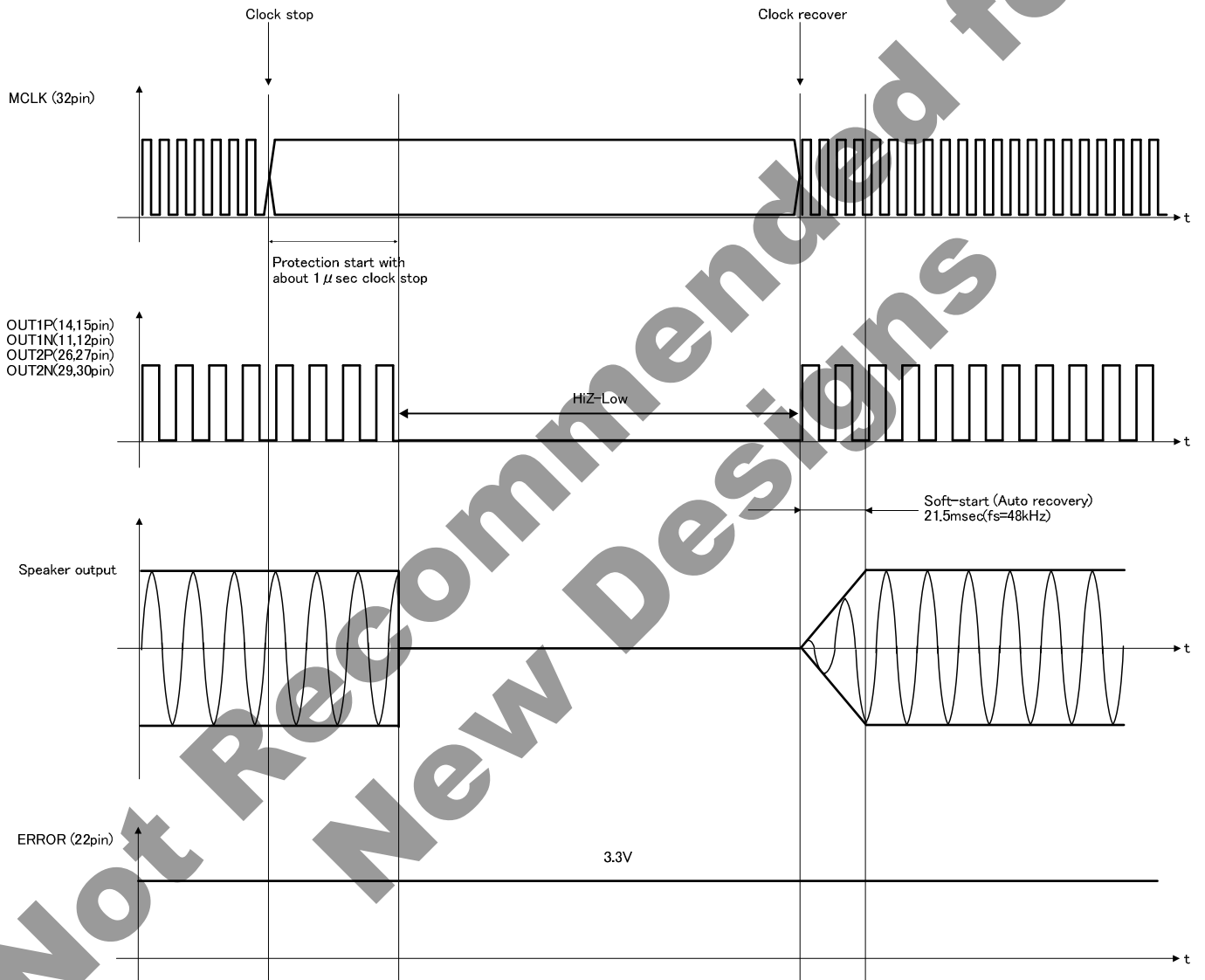

Figure 53. Sequence of Clock stop protection(MCLK)

9) Clock stop protection(BCLK)

This IC has the clock stop protection circuit that make the speaker output mute when the BCLK signal of the digital audio input stops.

Detecting condition - It will detect when MUTE pin is set High and the BCLK signal stops for about 1usec or more. Speaker output turns MUTE immediately, when clock stop protection is detected.

Releasing condition - It will release when MUTE pin is set High and the BCLK signal returns to the normal clock operation. The speaker output is outputted through a soft-start when released. (Auto recovery)

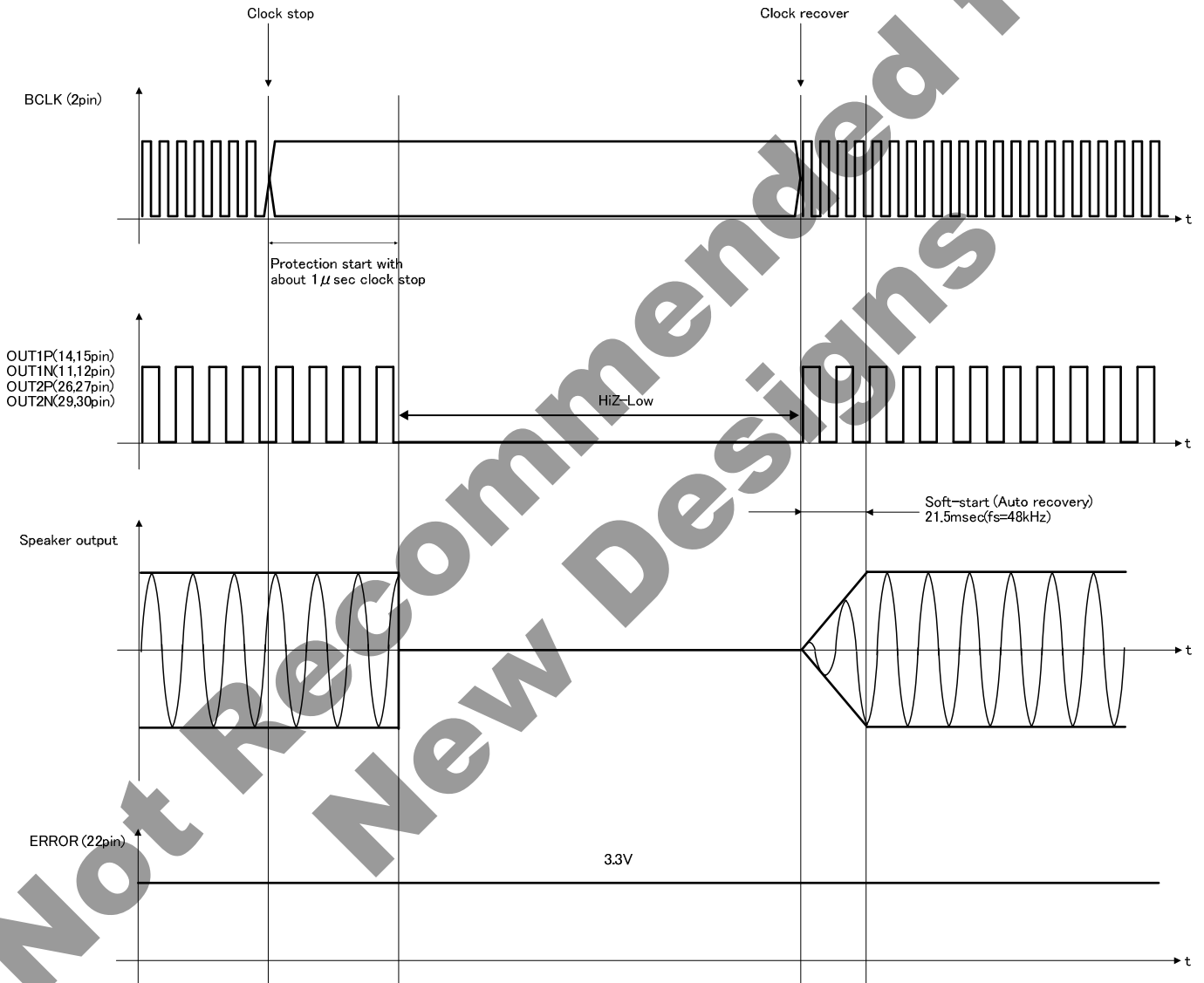

Figure 54. Sequence of Clock stop protection(BCLK)

10) Clock stop protection(LRCLK)

This IC has the clock stop protection circuit that make the speaker output mute when the LRCLK signal of the digital audio input stops.

Detecting condition - It will detect when MUTE pin is set High and the LRCLK signal stops for about 21 μ sec(at fs=48kHz) or more. Speaker output turn MUTE immediately, when clock stop protection is detected.

Releasing condition - It will release when MUTE pin is set High and the LRCLK signal returns to the normal clock operation. The speaker output is outputted through a soft-start when released. (Auto recovery)

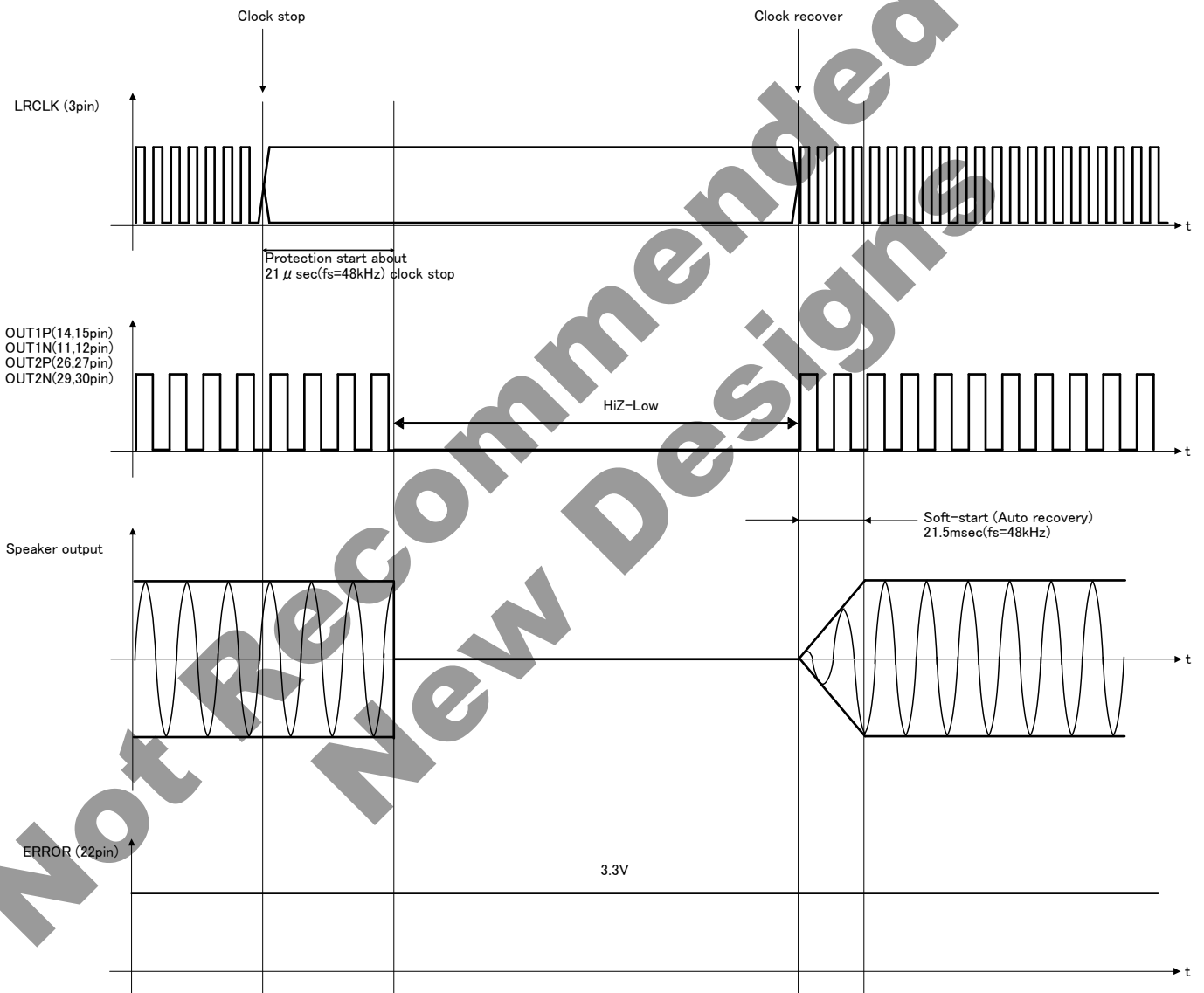

Figure 55. Sequence of Clock stop protection(LRCLK)

●Application Circuit Example1

Stereo BTL Output, $R_L=8\Omega$, $V_{cc}=10V$ to $16V$

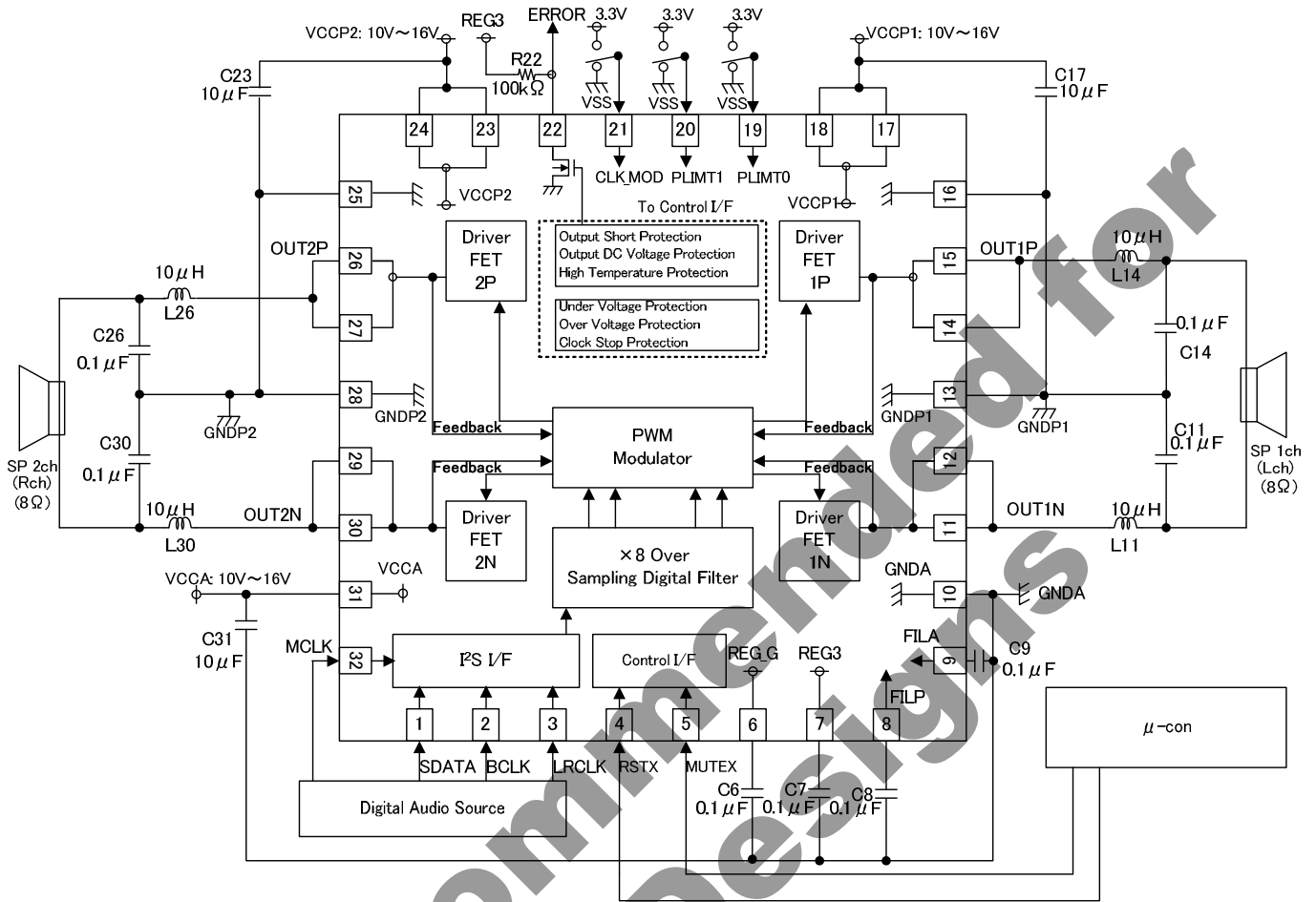

Figure 56. Application circuit1

●BOM List1

Stereo BTL Output, $R_L=8\Omega$, $V_{cc}=10V$ to $16V$

Parts	Parts No.	Value	Company	Product No.	Rated Voltage	Tolerance	Size
IC	U1	—	ROHM	BD5452AMUV	—	—	5.0mmx5.0mm
Inductor	L11, L14, L26, L30	10 μ H	TOKO	B1047AS-100M	-	($\pm 20\%$)	7.6mmx7.6mm
Resistor	R22	100k Ω	ROHM	MCR03EZPJ104	1/10W	J($\pm 5\%$)	1.6mmx0.8mm
Capacitor	C17, C23, C31	10uF	MURATA	GRM31CB11E106KA75L	25V	B($\pm 10\%$)	3.2mmx1.6mm
	C6, C7 C8, C9	0.1uF		GRM188B11A104KA92D	10V	B($\pm 10\%$)	1.6mmx0.8mm
	C11, C14, C26, C30	0.1uF		GRM188B11E104KA01D	25V	B($\pm 10\%$)	1.6mmx0.8mm

As return of current regenerated by back EMF of output coil happens, take steps such as putting capacitor between power supply and GND as an electric pathway for the regenerated current. Be sure that there is no problem with each property such as emptied capacity at lower temperature regarding electrolytic capacitor to decide capacity value. If the connected power supply does not have sufficient current absorption capacity, regenerative current will cause the voltage on the power supply line to rise, which combined with the product and its peripheral circuitry may exceed the absolute maximum ratings. It is recommended to implement a physical safety measure such as the insertion of a voltage clamp diode between the power supply and GND pins.

●Application Circuit Example 2

Monaural BTL Output, $R_L=8\Omega$, $V_{cc}=10V$ to $16V$

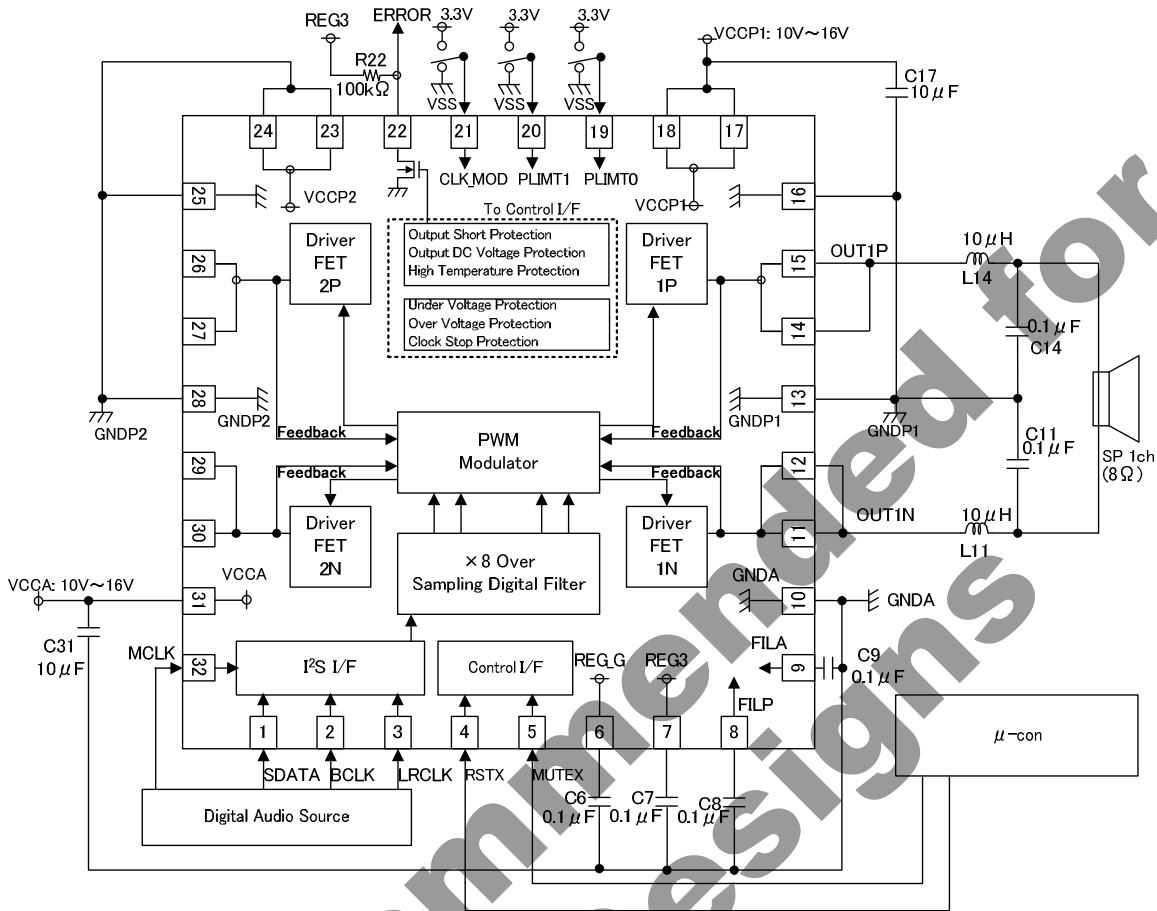

Figure 57. Application Circuit 2

●BOM List2

Monaural BTL Output, $R_L=8\Omega$, $V_{cc}=10V$ to $16V$

Parts	Parts No.	Value	Company	Product No.	Rated Voltage	Tolerance	Size
IC	U1	—	ROHM	BD5452AMUV	—	—	5.0mmx5.0mm
Inductor	L11, L14	10μH	TOKO	B1047AS-100M	-	(±20%)	7.6mmx7.6mm
Resistor	R22	100kΩ	ROHM	MCR03EZPJ104	1/10W	J(±5%)	1.6mmx0.8mm
Capacitor	C17, C31	10uF	MURATA	GRM31CB11E106KA75L	25V	B(±10%)	3.2mmx1.6mm
	C6, C7 C8, C9	0.1uF		GRM188B11A104KA92D	10V	B(±10%)	1.6mmx0.8mm
	C11, C14	0.1uF		GRM188B11E104KA01D	25V	B(±10%)	1.6mmx0.8mm

As return of current regenerated by back EMF of output coil happens, take steps such as putting capacitor between power supply and GND as an electric pathway for the regenerated current. Be sure that there is no problem with each property such as emptied capacity at lower temperature regarding electrolytic capacitor to decide capacity value. If the connected power supply does not have sufficient current absorption capacity, regenerative current will cause the voltage on the power supply line to rise, which combined with the product and its peripheral circuitry may exceed the absolute maximum ratings. It is recommended to implement a physical safety measure such as the insertion of a voltage clamp diode between the power supply and GND pins.

●Application Circuit Example 3

Stereo BTL Output, $R_L=8\Omega$, $V_{CC}=16V$ to $18V$

※To prevent going over absolute maximum rating by the leap out of power supply and the linking of PWM output wave form, please provide countermeasure shown below diagram (dot-line) when using at $V_{CC}>16V$.

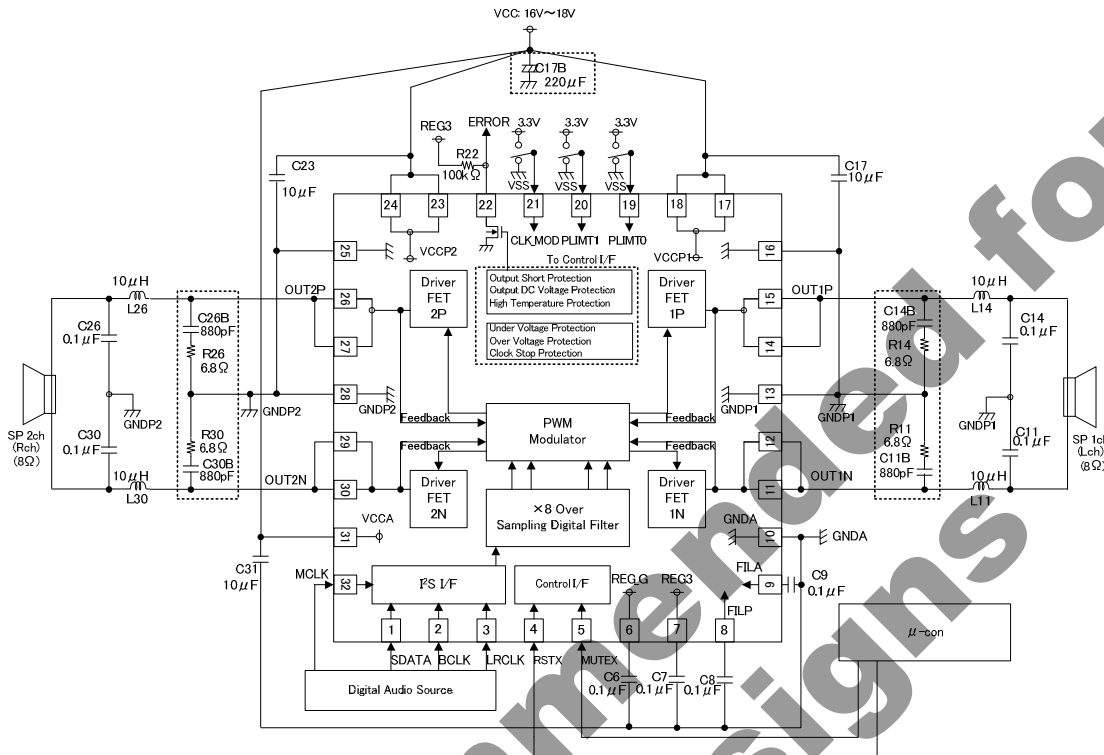

Figure 58. Application Circuit Example 3

●BOM List 3

Stereo BTL Output, $R_L=8\Omega$, $V_{CC}=16V$ to $18V$

Parts	Parts No.	Value	Company	Product No.	Rated	Tolerance	Size
IC	U1	—	ROHM	BD5452AMUV	—	—	5.0mmx5.0mm
Inductor	L11, L14, L26, L30	10µH	TOKO	B1047AS-100M	-	(±20%)	7.6mmx7.6mm
Resistor	R22	100kΩ	ROHM	MCR03EZPJ104	1/10W	J(±5%)	1.6mmx0.8mm
	R11, R14, R26, R30	6.8Ω		MCR03EZPFL6R80	1/10W	F(±5%)	1.6mmx0.8mm
Capacitor	C17, C23, C31	10uF	MURATA	GRM31CB11E106KA75L	25V	B(±10%)	3.2mmx1.6mm
	C6, C7, C8, C9	0.1uF		GRM188B11A104KA92D	10V	B(±10%)	1.6mmx0.8mm
	C11, C14, C26, C30	0.1uF		GRM188B11A104KA01D	25V	B(±10%)	1.6mmx0.8mm
	C11B, C14B, C26B, C30B	680pF		GRM188B11E681KA01	25V	B(±10%)	1.6mmx0.8mm
Electrolytic Capacitor	C17B	220µF	Panasonic	ECA1EMH221	25V	±20%	φ8mmx11.5mm

As return of current regenerated by back EMF of output coil happens, take steps such as putting capacitor between power supply and GND as an electric pathway for the regenerated current. Be sure that there is no problem with each property such as emptied capacity at lower temperature regarding electrolytic capacitor to decide capacity value. If the connected power supply does not have sufficient current absorption capacity, regenerative current will cause the voltage on the power supply line to rise, which combined with the product and its peripheral circuitry may exceed the absolute maximum ratings. It is recommended to implement a physical safety measure such as the insertion of a voltage clamp diode between the power supply and GND pins.

●Application Circuit Example 4

Monaural BTL Output, $R_L=8\Omega$, $V_{CC}=16V$ to $18V$

※To prevent going over absolute maximum rating by the leap out of power supply and the linking of PWM output wave form, please provide countermeasure shown below diagram (Red dot-line) when using at $V_{CC}>16V$.

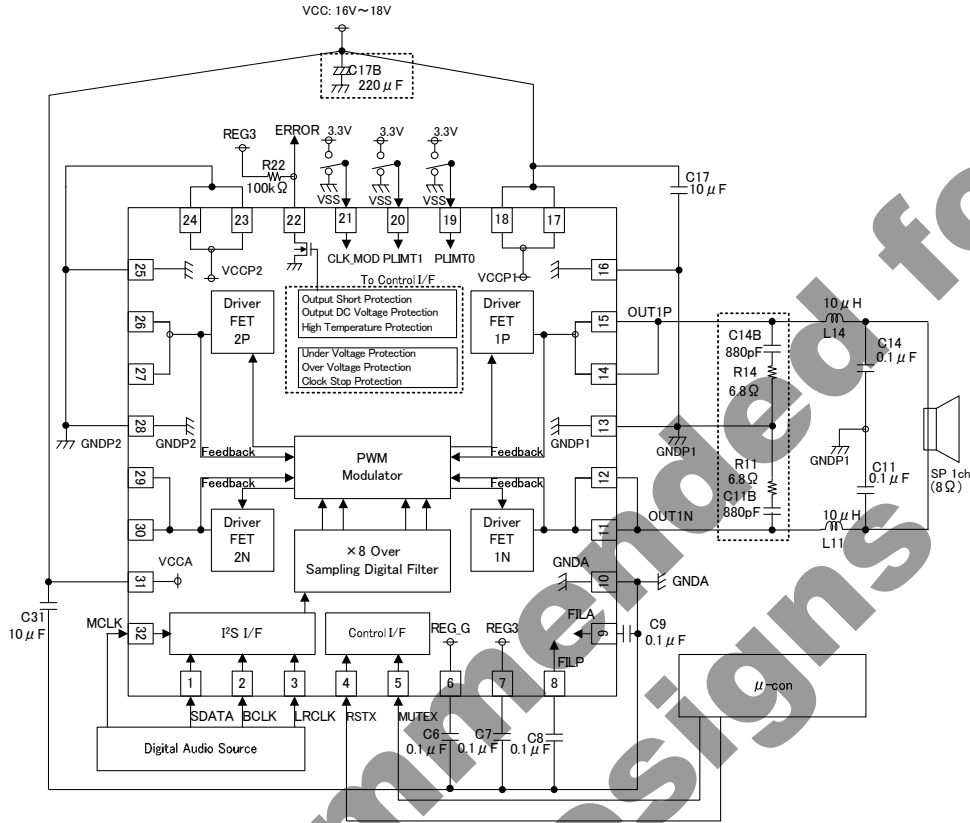

Figure 59. Application Circuit Example 4

●BOM List 4

Monaural BTL Output, $R_L=8\Omega$, $V_{CC}=16V$ to $18V$

Parts	Parts No.	Value	Company	Product No.	Rated	Tolerance	Size
IC	U1	—	ROHM	BD5452AMUV	—	—	5.0mmx5.0mm
Inductor	L11, L14	10μH	TOKO	B1047AS-100M	-	(±20%)	7.6mmx7.6mm
Resistor	R22	100kΩ	ROHM	MCR03EZPJ104	1/10W	J(±5%)	1.6mmx0.8mm
	R11, R14	6.8Ω		MCR03EZPFL6R80	1/10W	F(±5%)	1.6mmx0.8mm
Capacitor	C17, C31	10uF	MURATA	GRM31CB11E106KA75L	25V	B(±10%)	3.2mmx1.6mm
	C6, C7 C8, C9	0.1uF		GRM188B11A104KA92D	10V	B(±10%)	1.6mmx0.8mm
	C11, C14	0.1uF		GRM188B11A104KA01D	25V	B(±10%)	1.6mmx0.8mm
	C11B, C14B	680pF		GRM188B11E681KA01	25V	B(±10%)	1.6mmx0.8mm
Electrolytic Capacitor	C17B	220μF	Panasonic	ECA1EMH221	25V	±20%	φ8mmx11.5mm

As return of current regenerated by back EMF of output coil happens, take steps such as putting capacitor between power supply and GND as an electric pathway for the regenerated current. Be sure that there is no problem with each property such as emptied capacity at lower temperature regarding electrolytic capacitor to decide capacity value. If the connected power supply does not have sufficient current absorption capacity, regenerative current will cause the voltage on the power supply line to rise, which combined with the product and its peripheral circuitry may exceed the absolute maximum ratings. It is recommended to implement a physical safety measure such as the insertion of a voltage clamp diode between the power supply and GND pins.

●About circuit board layout

Be careful of the following order of priority, and design a circuit board layout.

- ①C13 · C27 · C31(10uF) put shortest compared with VCC and GND.
- ②C6 · C7 · C8 · C9(0.1uF) put shortest compared with VCC and GND.
- ③The thermal pattern on the back connected with the GND.
- ④Each GND line connected by one point without common impedance.
- ⑤Each power supply and each GND are divided
- ⑥GND pattern of both side connected with the a lot of VIA electric contacts to lower the impedance of GND.
- ⑦GND area of the heat radiation area widen to improve the heat radiation ability.

Reference : ROHM designed 4 layer board

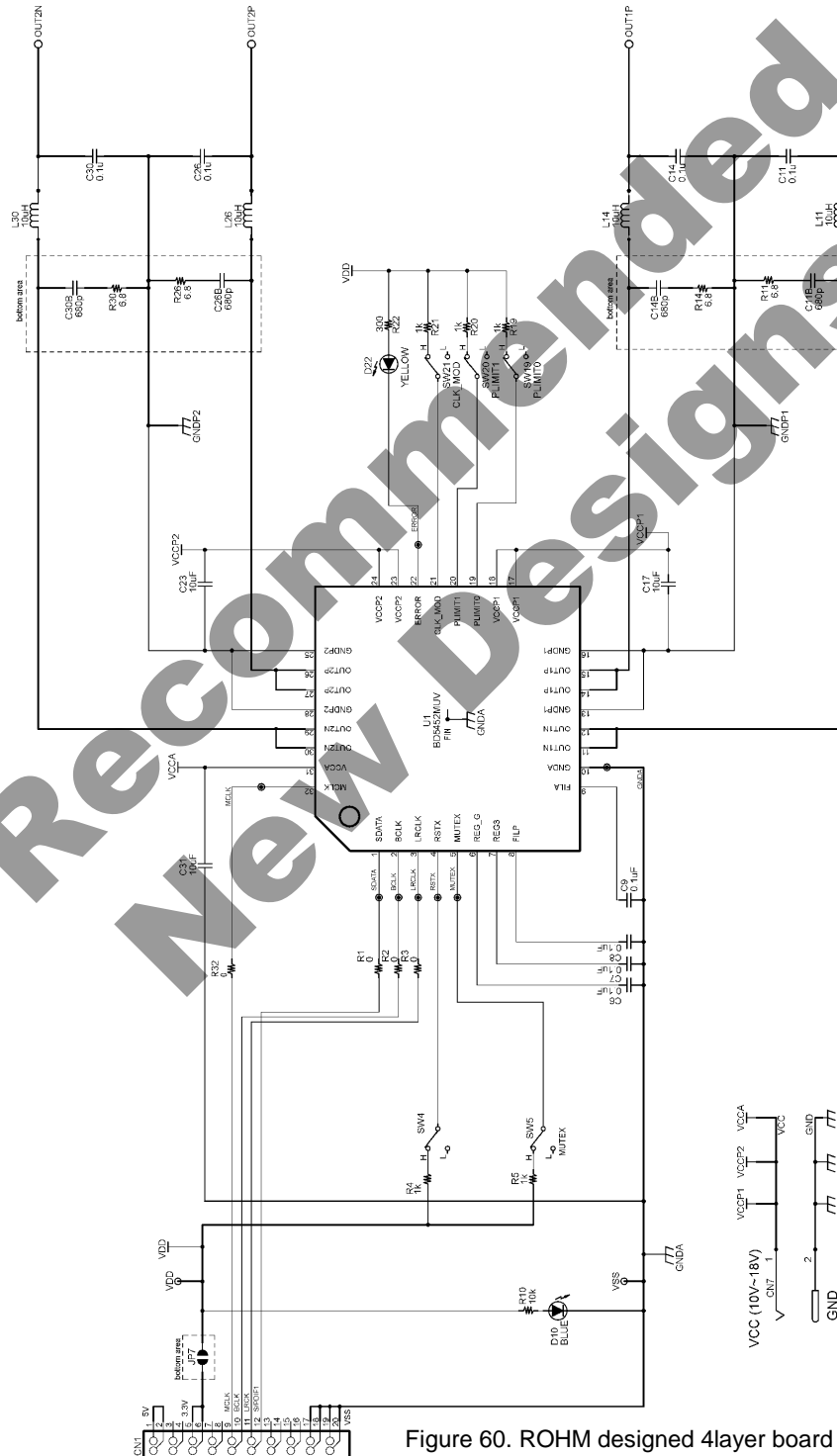

Figure 60. ROHM designed 4layer board

Reference : ROHM designed 4 layer board SilkScreen

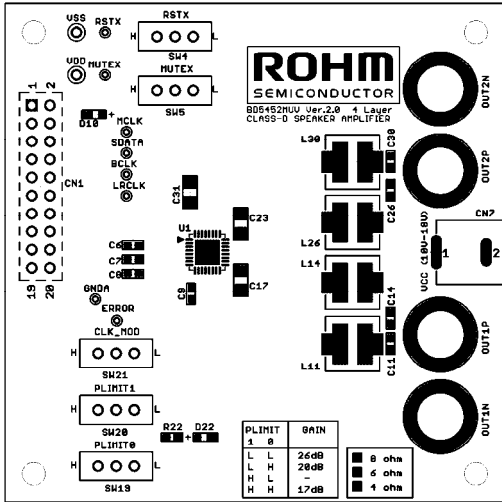

Figure 61. Top Layer Silk Screen (Top View)

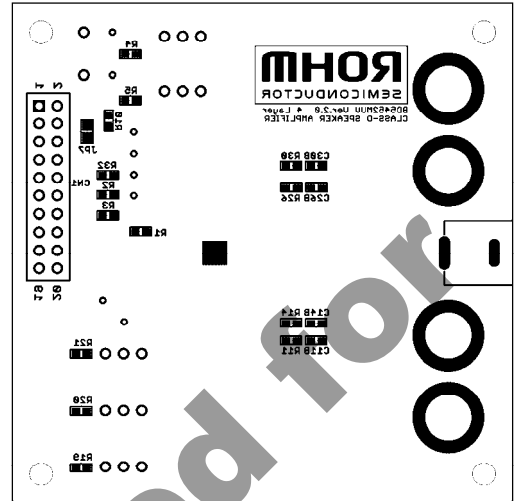

Figure 62. Bottom Layer Silk Screen (Top View)

ROHM designed 4 layer board Copper Layer

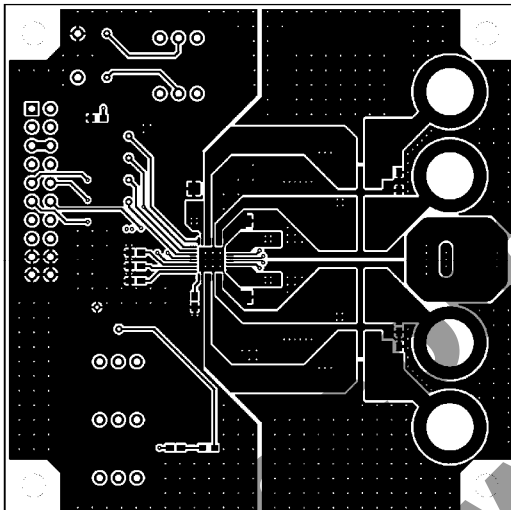

Figure 63. Top Copper Layer (Top View)

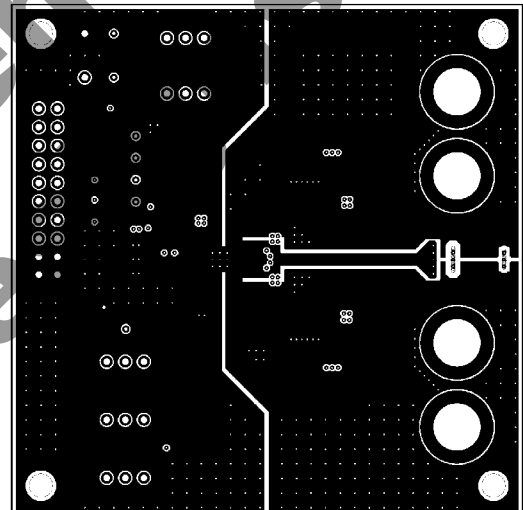

Figure 64. Mid Copper Layer1 (Top View)

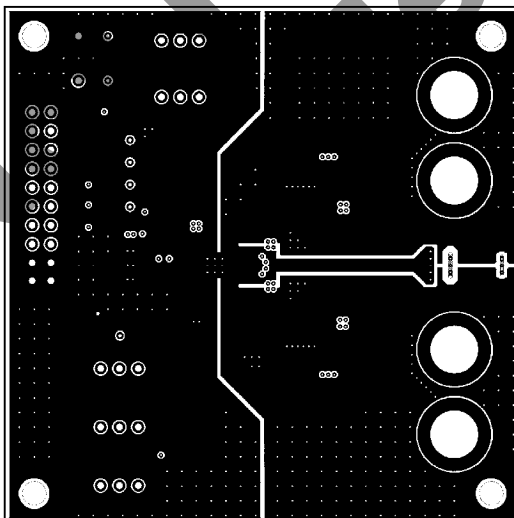

Figure 65. Mid Copper Layer2 (Top View)

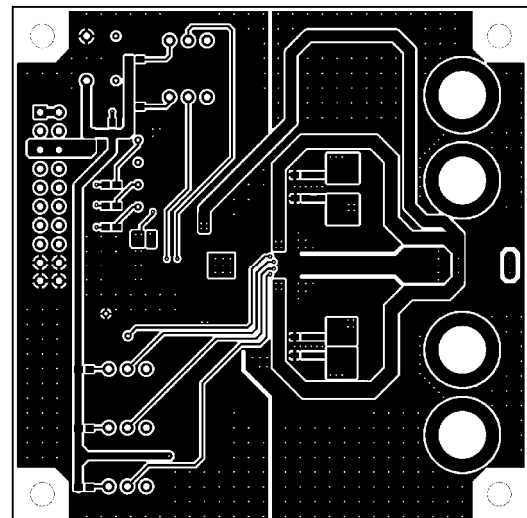

Figure 66. Bottom Copper Layer (Top View)

●About the two pieces use of BD5452AMUV

Be careful of the following point, when you have two BD5452AMUVs used at the same time. It is charged with electricity to GND of LC-Filter for the SW element removal. When you have two BD5452AMUVs used at the same time and PWM output synchronized, there is common impedance in GND of Filter, the GND electric potential is raised, and it becomes the aggravation cause of the noise. The GND of Filter is to short in one point when you use two BD5452AMUVs at the same time. There is no mechanism of the phase control in BD5452AMUV.

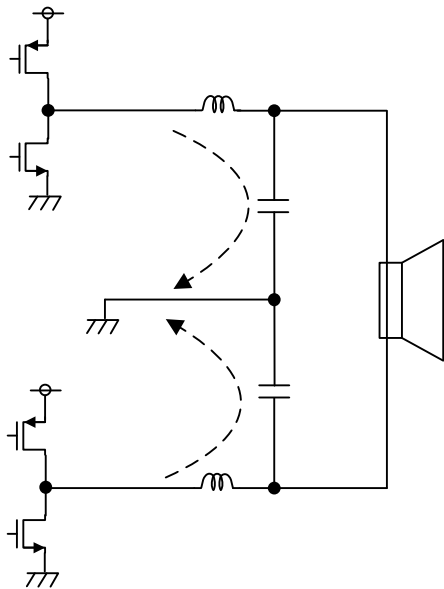

Figure 67. Output LC filter

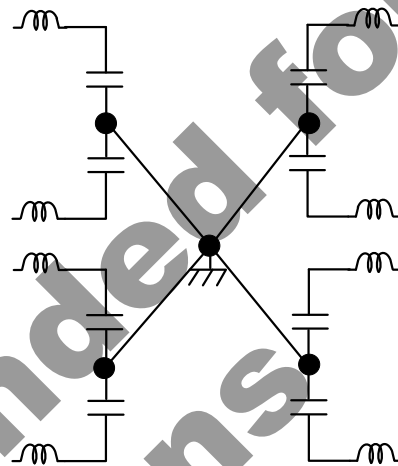

Figure 68. circuit at the time of the two use

●How to select an application parts

1) Output LC Filter Circuit

An output filter is required to eliminate radio-frequency components exceeding the audio-frequency region supplied to a load (speaker). Because this IC uses sampling clock frequencies from 256kHz($f_s=32\text{kHz}$) to 384kHz($f_s=48\text{kHz}$) in the output PWM signals, the high-frequency components must be appropriately removed. This section takes an example of an LC type LPF shown below, in which coil L and capacitor C compose a differential filter with an attenuation property of -12dB/oct. A large part of switching currents flow to capacitor C, and only a small part of the currents flow to speaker R_L . This filter reduces unwanted emission this way. In addition, coil L and capacitor C_g compose a filter against in-phase components, reducing unwanted emission further.

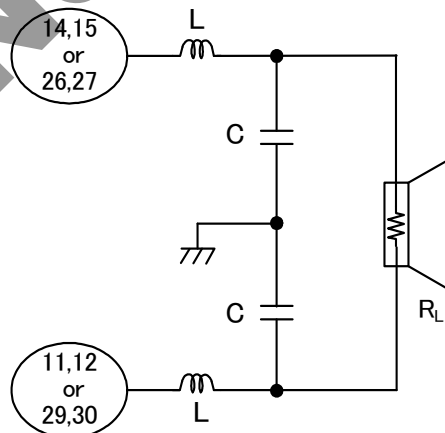

Figure 69. Output LC filter

Following presents output LC filter constants with typical load impedances.

R _L	L	C
4Ω	10μH	0.47μF
6Ω	10μH	0.15μF
8Ω	10μH	0.1μF

Use coils with a low direct-current resistance and with a sufficient margin of allowable currents. A high direct-current resistance causes power losses. In addition, select a closed magnetic circuit type product in normal cases to prevent unwanted emission.

Use capacitors with a low equivalent series resistance, and good impedance characteristics at high frequency ranges (100kHz or higher). Also, select an item with sufficient withstand voltage because flowing massive amount of high-frequency currents is expected.

2) The value of the LC filter circuit computed equation

The output LC filter circuit of BD5452AMUV is as it is shown in Figure 70. The LC filter circuit of Figure 70 is thought to substitute it like Figure 71 on the occasion of the computation of the value of the LC filter circuit.

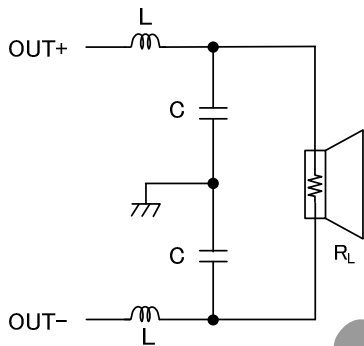

Figure 70. Output LC filter 1

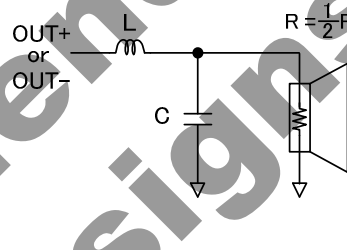

Figure 71. Output LC filter 2

The transfer function H(s) of the LC filter circuit of Figure 71 becomes the following.

$$H(s) = \frac{1}{LC} \cdot \frac{1}{s^2 + \frac{1}{CR}s + \frac{1}{LC}} = \frac{\omega^2}{s^2 + \frac{\omega}{Q}s + \omega^2}$$

The ω and Q become the followings here.

$$\omega^2 = \frac{1}{LC} \quad \omega = 2\pi f_{CL} \quad f_{CL} = \frac{1}{2\pi\sqrt{LC}}$$

$$Q = R\sqrt{\frac{C}{L}} = \frac{1}{2}R_L\sqrt{\frac{C}{L}}$$

Therefore, L and C become the followings.

$$L = \frac{1}{\omega^2 C} = \frac{R_L}{4\pi^2 f_{CL}^2 Q} \quad C = \frac{Q}{\omega R} = \frac{Q}{\pi f_{CL} R_L}$$

The R_L and L should be made known, and f_{CL} is set up, and C is decided.

3) The settlement of the L value of the coil

A standard for selection of the L value of a coil to use is to take the following back anti-matter into consideration except for the factor such as a low castigation, miniaturization, pale pattern. It is being made L=10uH with BD5452AMUV in consideration of a balance of the total.

①When L value was made small.

- (1) Circuit electric currents increase without a signal. And, efficiency in the low output gets bad.
- (2) Direct current resistance value is restrained small when the coil of other L value and size are made the same. Therefore, maximum output is easy to take out. And, it can be used in the low power supply voltage because DC electric current (allowable electric current) value can be taken greatly.

②When L value was made large.

- (1) Circuit electric current is restrained low without a signal. Efficiency in the low output improves.
- (2) Direct current resistance value grows big when the coil of other L value and size are made the same. Therefore, maximum output is hard to take out. And, because it becomes small, use becomes difficult 【 the DC electric current (allowable electric current) value 】 in the low power supply voltage, too.

4) The settlement of the f_cL

As for the settlement of the fixed number of the LC filter circuit, it is taken into consideration about two points of the following, and set up.

①The PWM sampling frequency f_{PWM} (=8f_s) of BD5452AMUV is set up in 384kHz (@f_s=48kHz).

It is set up with f_c < f_{PWM} to restrain career frequency omission after the LC filter circuit.

②When f_c is lowered too much, the voltage profit of the voice obi stage (especially, the neighborhood of 20kHz) declines in the speaker output frequency character of the difference movement mode.

And, the speaker output frequency character of the difference movement mode becomes the following.

RL=8Ω				RL=6Ω				RL=4Ω			
L[uH]	C[uF]	f _c [kHz]	Q	L[uH]	C[uF]	f _c [kHz]	Q	L[uH]	C[uF]	f _c [kHz]	Q
10	0.1	75.32	0.40	10	0.1	51.01	0.30	10	0.1	32.19	0.20
	0.15	80.85	0.49		0.15	54.76	0.37		0.15	33.35	0.24
	0.22	86.79	0.59		0.22	56.73	0.44		0.22	34.55	0.30
	0.33	89.92	0.73		0.33	63.1	0.54		0.33	35.8	0.36
	0.47	86.79	0.87		0.47	66.68	0.65		0.47	38.37	0.43
15	0.1	46.99	0.33	15	0.1	33.11	0.24	15	0.1	21.68	0.16
	0.15	49.66	0.40		0.15	34.36	0.30		0.15	22.08	0.20
	0.22	53.46	0.48		0.22	35.65	0.36		0.22	22.49	0.24
	0.33	57.54	0.59		0.33	38.37	0.44		0.33	22.91	0.30
	0.47	59.7	0.71		0.47	41.3	0.53		0.47	23.77	0.35
22	0.1	30.76	0.27	22	0.1	22.49	0.20	22	0.1	14.72	0.13
	0.15	31.92	0.33		0.15	22.91	0.25		0.15	14.72	0.17
	0.22	33.73	0.40		0.22	23.77	0.30		0.22	15	0.20
	0.33	36.31	0.49		0.33	24.66	0.37		0.33	15.28	0.24
	0.47	39.08	0.58		0.47	26.06	0.44		0.47	15.56	0.29

5) About the EMI countermeasure

It can be confirmed with Chip Common Mode Choke Coil(DLY5ATN401) manufactured by Murata manufacturing, Chip inductor LCC3225T2R2MR manufactured by TAIYOYUDEN as a part EMI countermeasure except for the output LC filter recommended with P.30/46~P.33/46.

●Application Circuit Example5 (Stereo BTL Output, $R_L=8\Omega$, $V_{CC}=10V\sim 16V$)

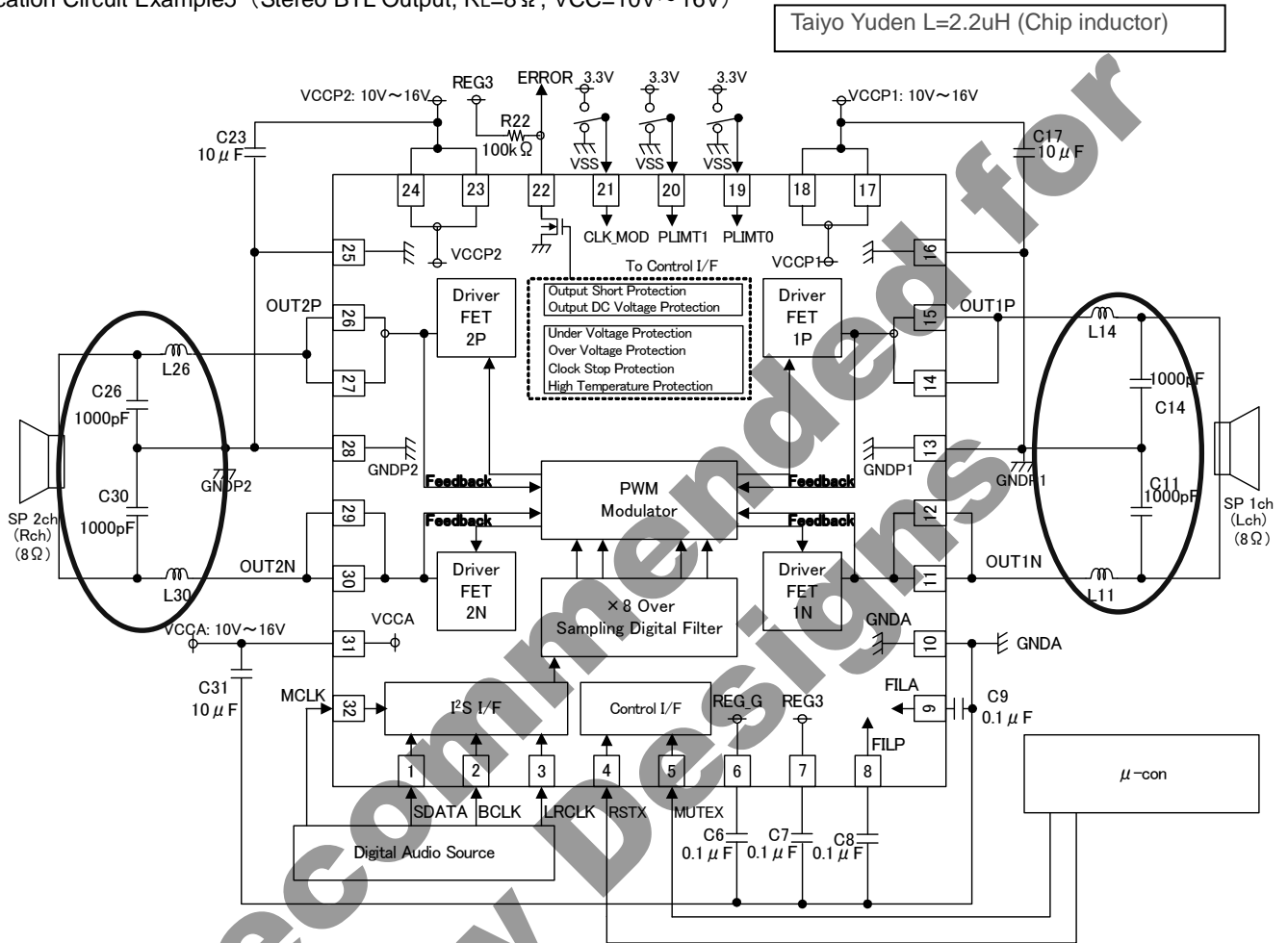

Figure 72. Application Circuit Example5

●BOM list 5 (Stereo BTL Output, $R_L=8\Omega$, $V_{CC}=10V\sim 16V$)

Parts	Parts No.	Value	Company	Product No.	Rated Voltage	Tolerance	Size
IC	U1	—	ROHM	BD5452AMUV	—	—	5.0mmx5.0mm
Inductor	L11, L14, L26, L30	2.2μH	Taiyo Yuden	LCC3225T2R2MR	1.5A	(±20%)	3.2mmx2.5mm
Resistor	R22	100kΩ	ROHM	MCR03EZPJ104	1/10W	J(±5%)	1.6mmx0.8mm
Capacitor	C17, C23, C31	10uF	MURATA	GRM31CB11E106KA75L	25V	B(±10%)	3.2mmx1.6mm
	C6, C7, C8, C9	0.1uF		GRM188B11A104KA92D	10V	B(±10%)	1.6mmx0.8mm
	C11, C14, C26, C30	1000pF		GRM188B11H102KA01D	50V	B(±10%)	1.6mmx0.8mm

As return of current regenerated by back EMF of output coil happens, take steps such as putting capacitor between power supply and GND as an electric pathway for the regenerated current. Be sure that there is no problem with each property such as emptied capacity at lower temperature regarding electrolytic capacitor to decide capacity value. If the connected power supply does not have sufficient current absorption capacity, regenerative current will cause the voltage on the power supply line to rise, which combined with the product and its peripheral circuitry may exceed the absolute maximum ratings. It is recommended to implement a physical safety measure such as the insertion of a voltage clamp diode between the power supply and GND pins.

● Application Circuit Example 6 (Stereo BTL Output, $R_L=8\Omega$, $V_{CC}=10V\sim 16V$)

Murata common mode choke coil

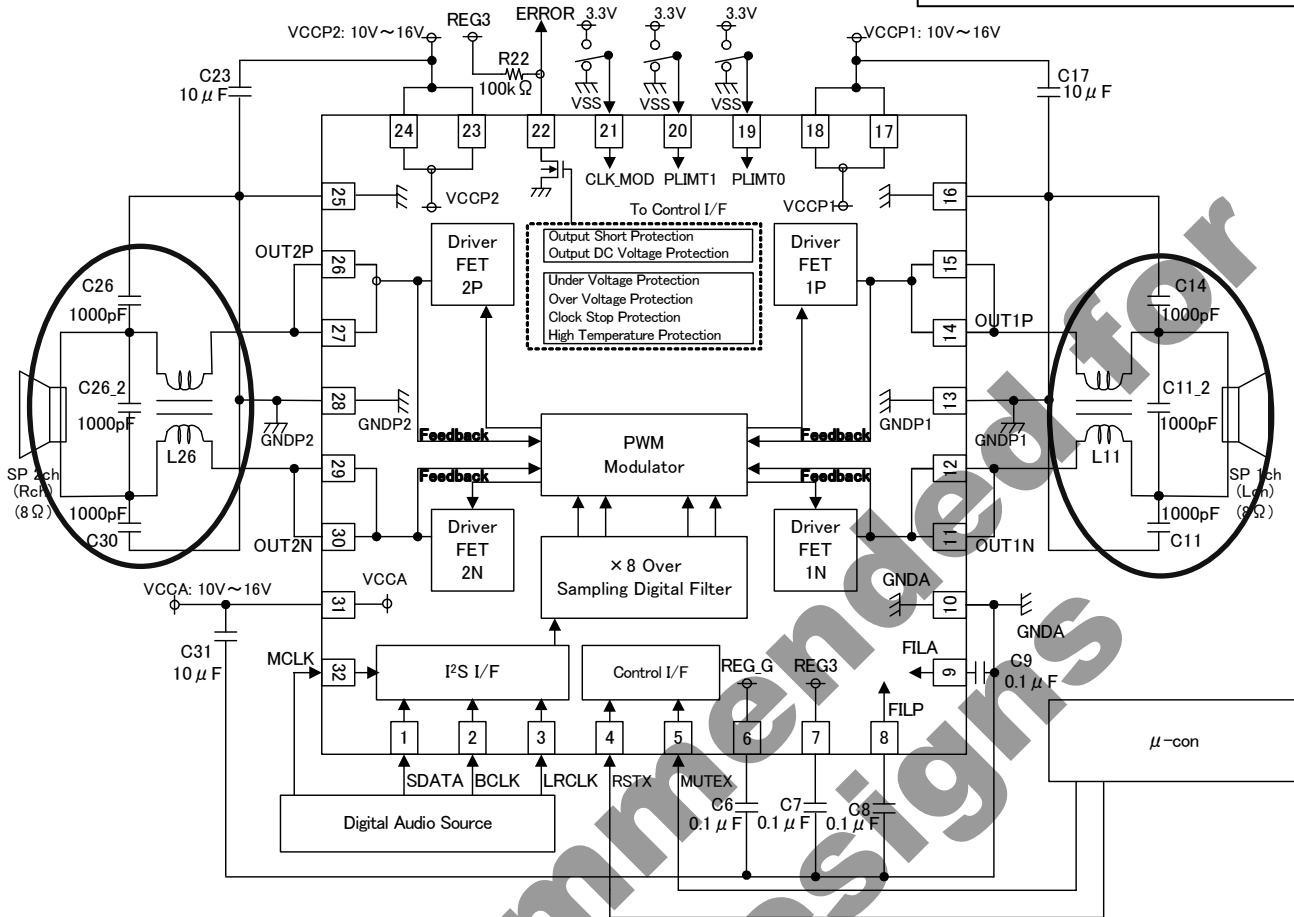

Figure 73. Application Circuit Example6

● BOM list 6 (Stereo BTL Output, $R_L=8\Omega$, $V_{CC}=10V\sim 16V$)

Parts	Parts No.	Value	Company	Product No.	Rated Voltage	Tolerance	Size
IC	U1	—	ROHM	BD5452AMUV	—	—	5.0mmx5.0mm
Common Mode Choke Coil	L11, L26	DC 0.024Ω	MURATA	DLY5ATN401SQ2	30V	(±40%)	3.6mmx5.0mm
Resistor	R22	100kΩ	ROHM	MCR03EZPJ104	1/10W	J(±5%)	1.6mmx0.8mm
Capacitor	C17, C23, C31	10uF	MURATA	GRM31CB11E106KA75L	25V	B(±10%)	3.2mmx1.6mm
	C6, C7 C8, C9	0.1uF		GRM188B11A104KA92D	10V	B(±10%)	1.6mmx0.8mm
	C11, C11_2,C14, C26, C26_2,C30	1000pF		GRM188B11H102KA01D	50V	B(±10%)	1.6mmx0.8mm

As return of current regenerated by back EMF of output coil happens, take steps such as putting capacitor between power supply and GND as an electric pathway for the regenerated current. Be sure that there is no problem with each property such as emptied capacity at lower temperature regarding electrolytic capacitor to decide capacity value. If the connected power supply does not have sufficient current absorption capacity, regenerative current will cause the voltage on the power supply line to rise, which combined with the product and its peripheral circuitry may exceed the absolute maximum ratings. It is recommended to implement a physical safety measure such as the insertion of a voltage clamp diode between the power supply and GND pins.

● Measurement data

(Unless otherwise specified $T_a=25^{\circ}\text{C}$, $V_{cc}=12\text{V}$, $f=1\text{kHz}$, $R_L=8\Omega$, $R_{STX}=3.3\text{V}$, $MUTEX=3.3\text{V}$, $PLIMIT0=L$, $PLIMIT1=L$, $f_s=48\text{kHz}$, $MCLK=256\text{fs}$.)

Measured by ROHM designed 4 layer board.

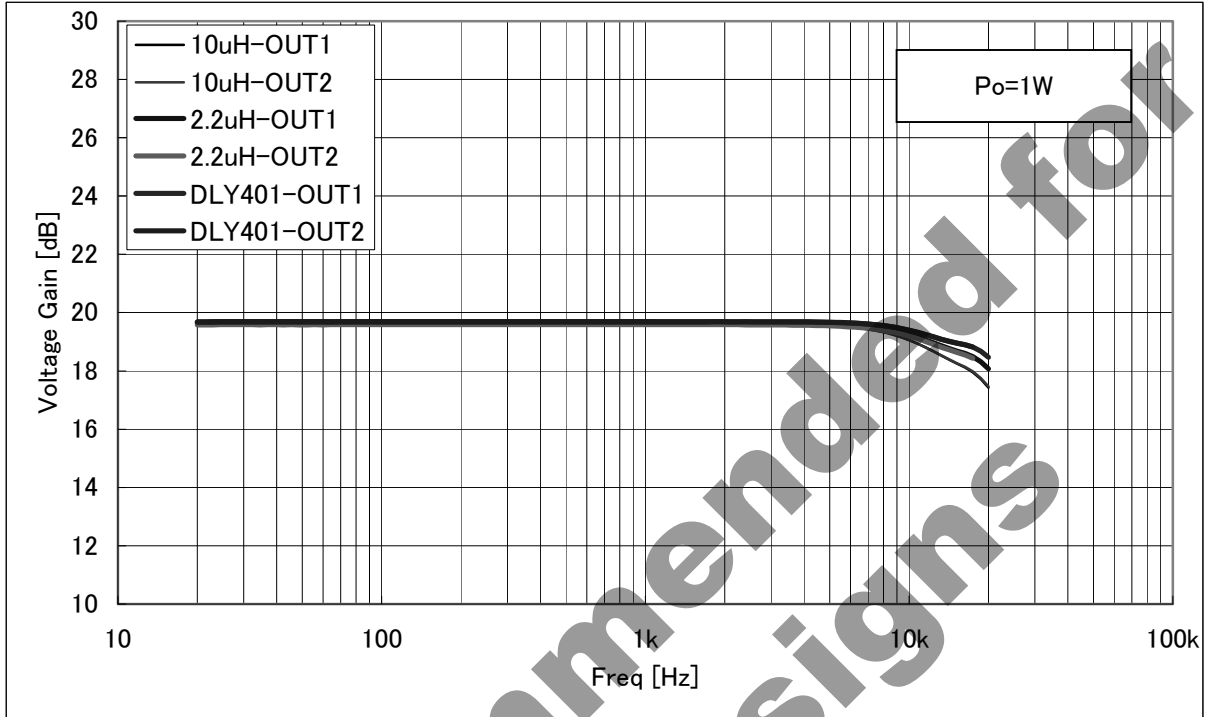

Figure 74. Frequency response

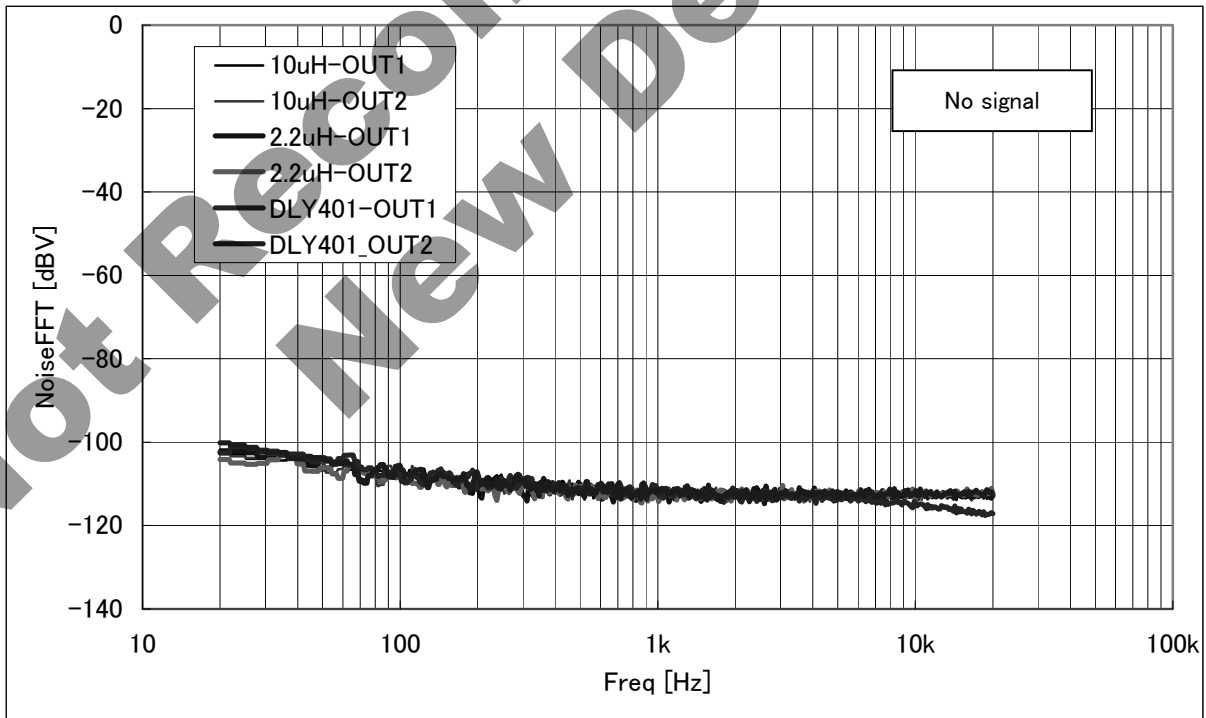

Figure 75. No input signal, test output noise (FFT)

● Measurement data

(Unless otherwise specified Ta=25°C, Vcc=12V, f=1kHz, RL=8Ω, RSTX=3.3V, MUTEX=3.3V, PLIMIT0=L, PLIMIT1=L, fs=48kHz, MCLK=256fs, Output LC filter : L=10uH, C=0.1uF) Measured by ROHM designed 4 layer board.

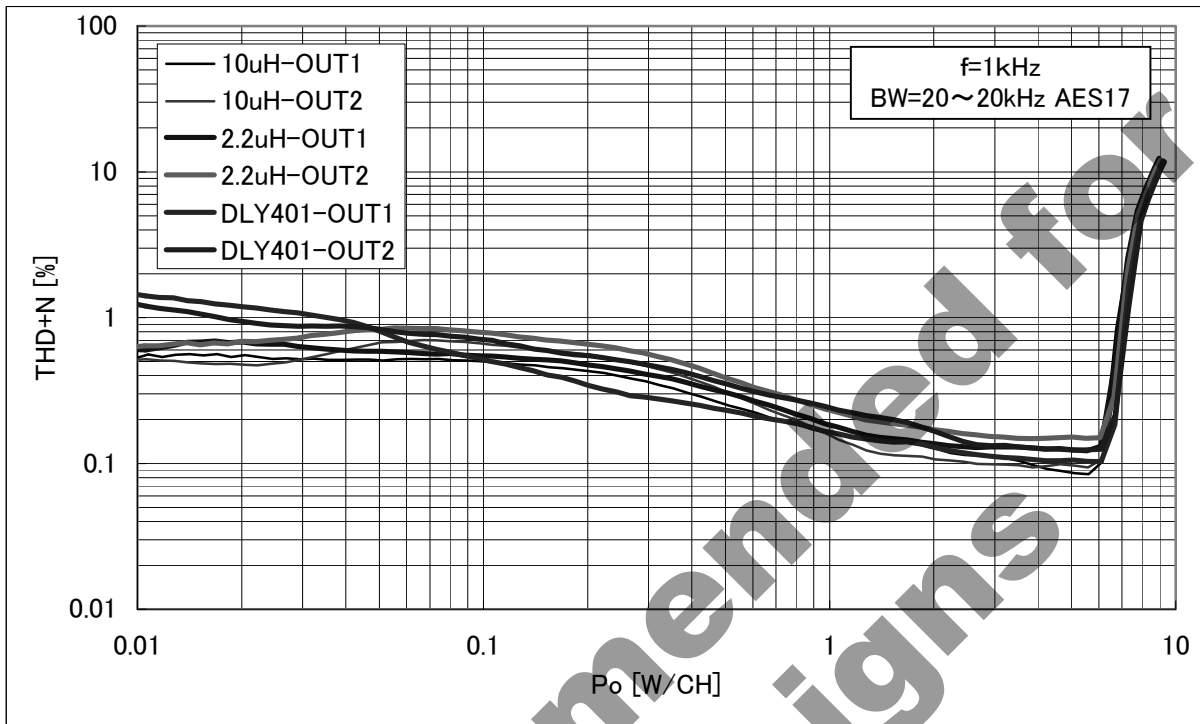

Figure 76. THD+N – OUTPUT POWER

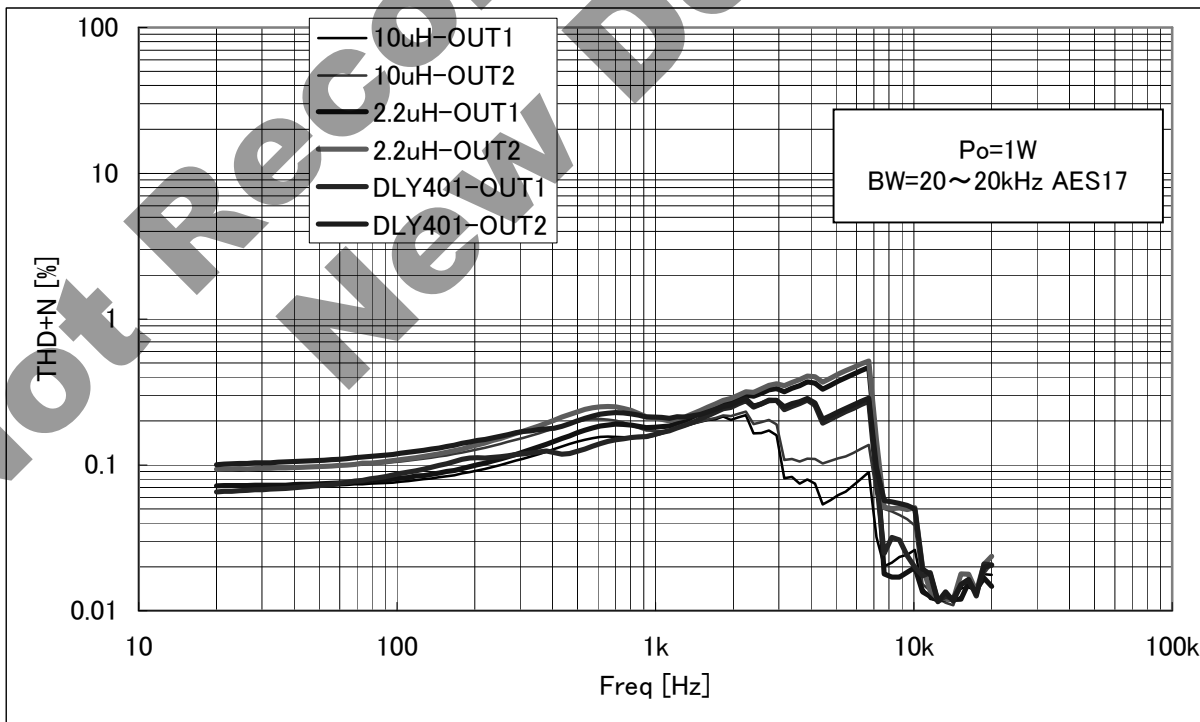

Figure 77. THD+N – Frequency

● Measurement data

(Unless otherwise specified Ta=25°C, Vcc=12V, f=1kHz, RL=8Ω, RSTX=3.3V, MUTEX=3.3V, PLIMIT0=L, PLIMIT1=L, fs=48kHz, MCLK=256fs, Output LC filter : L=10uH, C=0.1uF) Measured by ROHM designed 4 layer board.

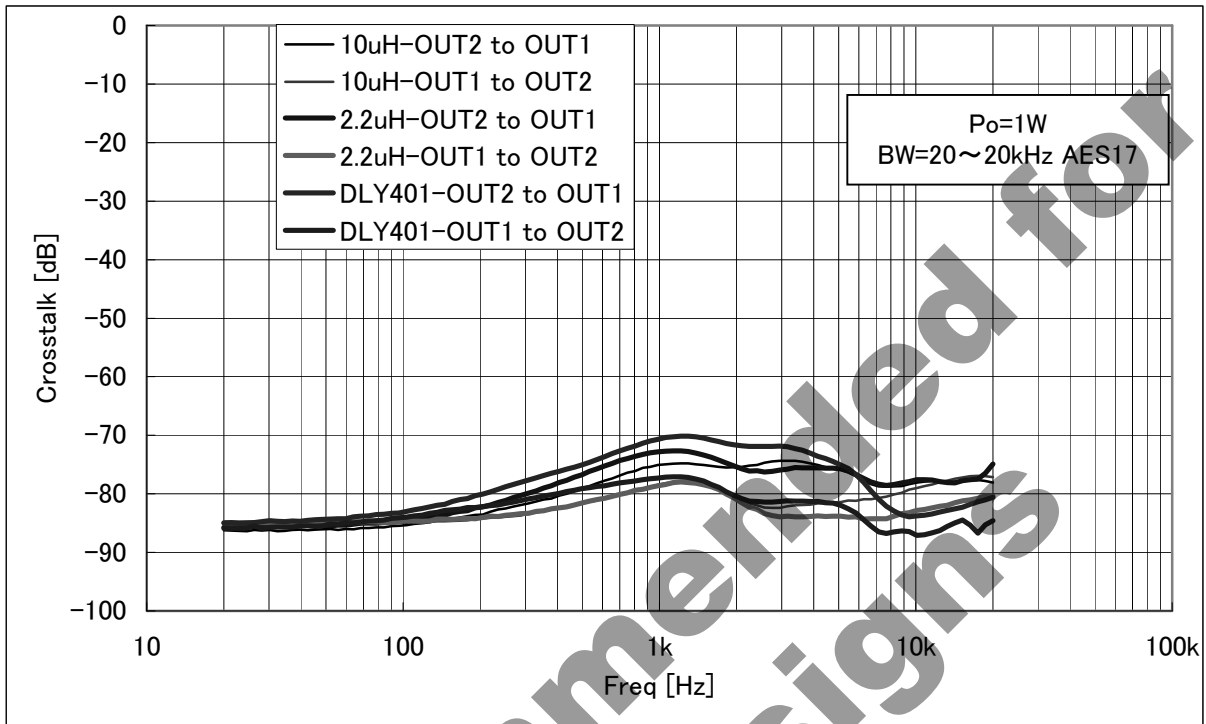

Figure 78. Crosstalk – Frequency

Not Recommended for New Designs

6) The settlement of the snubber

- ① Measure the spike resonance frequency f_1 of the PWM output wave shape (When it stands up.) by using FET probe in the OUT terminal. (Figure 80) The FET probe is to monitor very near pin and shorten ground lead at the time of that.
- ② Measure resonance frequency f_2 of the spike as a snubber circuit fixed number $R=0\Omega$ (Only with the condenser C , to connect GND) At this time, the value of the condenser C is adjusted until it becomes half of the frequency ($2f_2=f_1$) of the resonance frequency f_1 of ①. The value of C which it could get here is three times of the parasitic capacity C_p that a spike is formed. ($C=3C_p$)
- ③ Parasitic inductance L_p is looked for at the next formula.

$$L_p = \frac{1}{(2\pi f_1)^2 C_p}$$

- ④ The character impedance Z of resonance is looked for from the parasitic capacity C_p and the parasitism inductance L_p at the next formula.

$$Z = \sqrt{\frac{L_p}{C_p}}$$

- ⑤ A snubber circuit fixed number R is set up in the value which is the same as the character impedance Z . A snubber circuit fixed number C is set up in the value of 4-10 times of the parasitic capacity C_p . ($C=4C_p \sim 10C_p$) Decide it with trade-off with the character because switching electric currents increase when the value of C is enlarged too much.

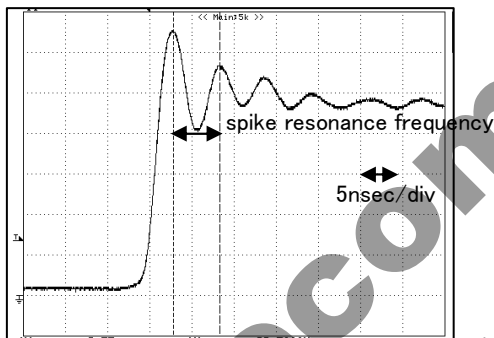

Figure 79. PWM Output waveform (measure of spike resonance frequency)

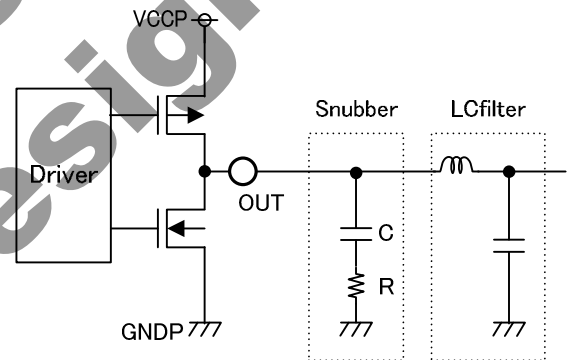

Figure 80. snubber schematic

● Power Dissipation

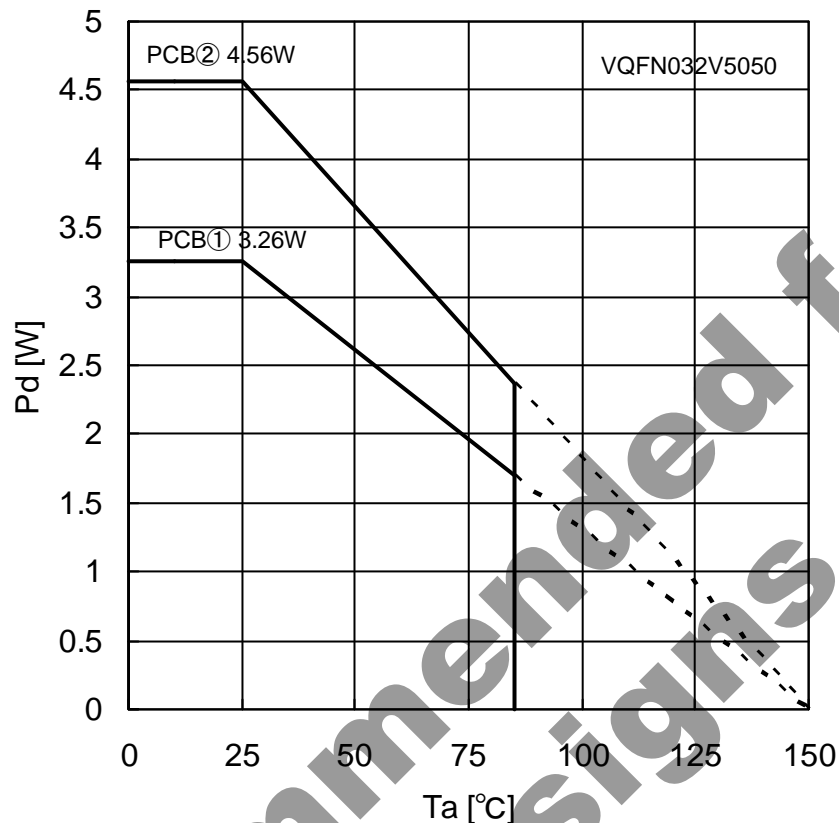

Figure 81. Allowable Power Dissipation

Measuring instrument : TH-156 (Shibukawa Kuwano Electrical Instruments Co., Ltd.)

Measuring conditions : Installation on ROHM's board

Board size : 74.2mm × 74.2mm × 1.6mm (with thermal via on board)

Material : FR4

- The board on exposed heat sink on the back of package are connected by soldering.

PCB① : 4-layer board (Top and bottom layer back copper foil size: 20.2mm², 2nd and 3rd layer back copper foil size: 5505mm²), $\theta_{ja} = 36.48^{\circ}\text{C/W}$

PCB② : 4-layer board (back copper foil size: 5505mm²), $\theta_{ja} = 26.08^{\circ}\text{C/W}$

Use a thermal design that allows for a sufficient margin in light of the power dissipation (Pd) in actual operating conditions. This IC exposes its frame of the backside of package. Note that this part is assumed to use after providing heat dissipation treatment to improve heat dissipation efficiency. Try to occupy as wide as possible with heat dissipation pattern not only on the board surface but also the backside.

Class D speaker amplifier is high efficiency and low heat generation by comparison with conventional Analog power amplifier. However, In case it is operated continuously by maximum output power, Power dissipation (Pdiss) may exceed package dissipation. Please consider about heat design that Power dissipation (Pdiss) does not exceed Package dissipation (Pd) in average power (Poav). (T_{jmax} : Maximum junction temperature=150°C, T_a : Peripheral temperature[°C], θ_{ja} : Thermal resistance of package[°C/W], Poav : Average power[W], η : Efficiency)

$$\text{Package dissipation : } Pd \text{ (W)} = (T_{jmax} - T_a) / \theta_{ja}$$

$$\text{Power dissipation : } Pdiss \text{ (W)} = Poav \times (1/\eta - 1)$$

● Pin function explanation (Provided pin voltages are typ. Values) (1/2)

Pin No.	Pin name	Pin voltage	Pin explanation	Internal equivalence circuit
4	RSTX	0V	Reset pin for Digital circuit H: Reset OFF L: Reset ON	
5	MUTEX	0V	Speaker output mute control pin H: Mute OFF L: Mute ON	
1	SDATA	0V	Digital audio signal input pin	
2	BCLK			
3	LRCLK			
32	MCLK			
19	PLIMT0			
20	PLIMT1	Power limit setting terminal		
21	CLK_MOD	MCLK setting terminal		
10	GNDA	0V	GND pin for Analog signal	—
8	FILP	1.6 to 2.4V	Bias pin for PWM signal Please connect the capacitor.	
7	REG3	3.3V	Internal power supply pin for Digital circuit Please connect the capacitor.	
22	ERROR	—	Error flag pin Please connect pull-up resistor. H: While Normal L: While Error	
6	REG_G	5.0V	Internal power supply pin for Gate driver Please connect the capacitor.	

● Pin function explanation (Provided pin voltages are typ. Values) (2/2)

Pin No.	Pin name	Pin voltage	Pin explanation	Internal equivalence circuit
9	FILA	2.5V	Bias pin for PWM signal. Please connect the capacitor.	
31	VCCA	Vcc	Power supply pin for Analog signal	-
23,24	VCCP2	Vcc	Power supply pin for ch2 PWM signal Please connect the capacitor.	
26,27	OUT2P	Vcc to 0V	Output pin of ch2 positive PWM Please connect to Output LPF.	
25,28	GNDP2	0V	GND pin for ch2 PWM signal	
29,30	OUT2N	Vcc to 0V	Output pin of ch2 negative PWM Please connect to Output LPF.	
11,12	OUT1N	Vcc to 0V	Output pin of ch1 negative PWM Please connect to Output LPF.	
13,16	GNDP1	0V	GND pin for ch1 PWM signal	
14,15	OUT1P	Vcc to 0V	Output pin of ch1 positive PWM Please connect to Output LPF.	
17,18	VCCP1	-	Power supply pin for ch1 PWM signal Please connect the capacitor.	

● Terminal setting

1) RSTX pin, MUTEX pin function

RSTX	MUTEX	Normalcy		Error detecting	
		PWM output OUT1P, 1N, 2P, 2N	ERROR output	PWM output OUT1P, 1N, 2P, 2N	ERROR output
L	L/H	HiZ_L (Reset_mode)	H	HiZ_L (Reset_mode)	H
H	L	HiZ_L (MUTE_ON)	H	HiZ_L (MUTE_ON)	L
H	H	Normal Operation (MUTE_OFF)	H	HiZ_L (MUTE_ON)	L

※RSTX(4pin)terminal, MUTEX(5pin)terminal are internally pulled down by 50 kΩ (Typ.)

※With RSTX=L data of every register within IC (I²S / I/F part, ×8 over sampling digital filter part, latch circuit when detecting ERROR) becomes unnecessary.

2) CLK_MOD pin function

CLK_MOD	MCLK input
L	256fs
H	512fs

Because care for the POP sound isn't being done, Make it MUTE condition, and change CLK_MOD terminal logic when you change the mode during the movement.

3) PLIMIT pin function

PLIMIT1	PLIMIT0	Gain Setting(BTL)	Condition of power limit
L	L	26dB	off
L	H	20dB	Min. 10 W(at 8Ω)
H	L	— ※	— ※
H	H	17dB	Min. 5 W(at 8Ω)

※ Don't use this condition.

Because care for the POP sound isn't being done, Make it MUTE condition, and change CLK_MOD terminal logic when you change the mode during the movement.
 And, PowerLimit function of BD5452AMUV is decided as follows. Set it up corresponding to the used speaker because maximum output value varies according to the speaker load resistance value as mentioned in the mention in the following.

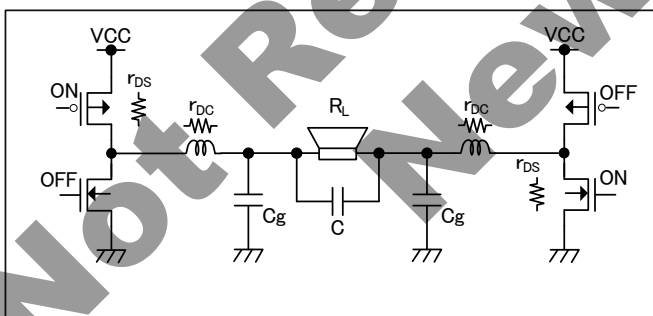
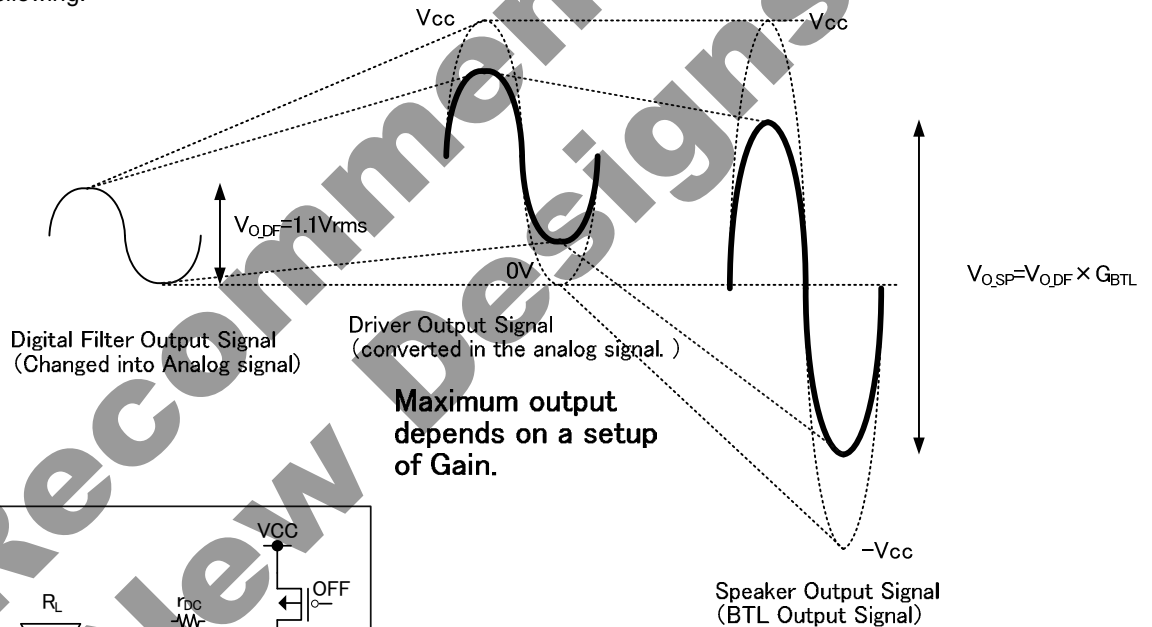

Figure.75 Schematic of output equivalent

$$V_{O_SP} = V_{O_DSP} \times 10^{\left(\frac{G_{BTL}}{20}\right)} \times \frac{R_L}{2(r_{DS} + r_{DC}) + R_L}$$

$$P_{O(THD=1\%)} = \frac{\left[\left(10^{\frac{V_{IN}}{20}} \right) \times 10^{\left(\frac{G_{BTL}}{20}\right)} \times \frac{R_L}{2(r_{DS} + r_{DC}) + R_L} \right]^2}{R_L}$$

- VIN : I2S Input level [dBFS]
- GBTL : Gain Setting [dB]
- RL : Load resistance [Ω]
- rDS : Resistance of FET [Ω]
(TYP.=0.3Ω)
- rDC : DC resistance of Coil [Ω]

●Notes for use

- 1) Absolute maximum ratings
Use of the IC in excess of absolute maximum ratings such as the applied voltage or operating temperature range may result in IC damage. Assumptions should not be made regarding the state of the IC (short mode or open mode) when such damage is suffered. A physical safety measure such as a fuse should be implemented when use of the IC in a special mode where the absolute maximum ratings may be exceeded is anticipated.
- 2) Power supply lines
As return of current regenerated by back EMF of output coil happens, take steps such as putting capacitor between power supply and GND as an electric pathway for the regenerated current. Be sure that there is no problem with each property such as emptied capacity at lower temperature regarding electrolytic capacitor to decide capacity value. If the connected power supply does not have sufficient current absorption capacity, regenerative current will cause the voltage on the power supply line to rise, which combined with the product and its peripheral circuitry may exceed the absolute maximum ratings. It is recommended to implement a physical safety measure such as the insertion of a voltage clamp diode between the power supply and GND pins.
- 3) GND potential (Pin 10, 13, 16, 25, 28) .
Any state must become the lowest voltage about GND terminal and VSS terminal.
- 4) Input terminal
The parasitic elements are formed in the IC because of the voltage relation. The parasitic element operating causes the wrong operation and destruction. Therefore, please be careful so as not to operate the parasitic elements by impressing to input terminals lower voltage than GND and VSS. Please do not apply the voltage to the input terminal when the power-supply voltage is not impressed.
- 5) Actions in strong magnetic field
Use caution when using the IC in the presence of a strong magnetic field as doing so may cause the IC to malfunction.
- 6) Thermal shutdown circuit
This product is provided with a built-in thermal shutdown circuit. When the thermal shutdown circuit operates, the output transistors are placed under open status. The thermal shutdown circuit is primarily intended to shut down the IC avoiding thermal runaway under abnormal conditions with a chip temperature exceeding $T_{jmax} = 150^{\circ}\text{C}$.
- 7) Shorts between pins and miss installation
When mounting the IC on a board, pay adequate attention to orientation and placement discrepancies of the IC. If it is missing installed and the power is turned on, the IC may be damaged. It also may be damaged if it is shorted by a foreign substance coming between pins of the IC or between a pin and a power supply or a pin and a GND.
- 8) Power supply on/off (Pin 17, 18, 23, 24, 31)
In case power supply is started up, RSTX (Pin 4) and MUTEX(Pin 5) always should be set Low. And in case power supply is shut down, it should be set Low likewise. Then it is possible to eliminate pop noise when power supply is turned on/off. And also, all power supply terminals should start up and shut down together.
- 9) ERROR terminal (Pin 22)
An error flag is outputted when Output short protection and DC voltage protection in the speaker are operated. These flags are the function which the condition of this product is shown in.
- 10) Precautions for Speaker-setting
If the impedance characteristics of the speakers at high-frequency range while increase rapidly, the IC might not have stable-operation in the resonance frequency range of the LC-filter. Therefore, consider adding damping-circuit, etc., depending on the impedance of the speaker
- 11) About short to VCC or GND after the LC filter
Though this IC has a short protection function, when short to VCC or GND after the LC filter a short protection function operate by over-electric current. But, Be fully careful because over/undershoot which exceeds a maximum standard by back electromotive force of the coil absolutely occurs and sometimes reaches it for the destruction.
- 12) About REG terminals
The REG terminal of BD5452AMUV doesn't aim at supplying it to the outside.
Therefore, don't connect the one except for Pullup of the condenser for the stabilization and the ERROR terminal.

Status of this document

The Japanese version of this document is formal specification. A customer may use this translation version only for a reference to help reading the formal version.

If there are any differences in translation version of this document formal version takes priority

●Ordering Information

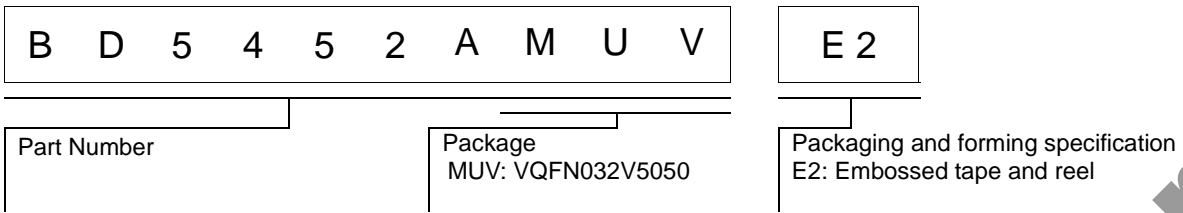

●Physical Dimension Tape and Reel Information

VQFN032V5050

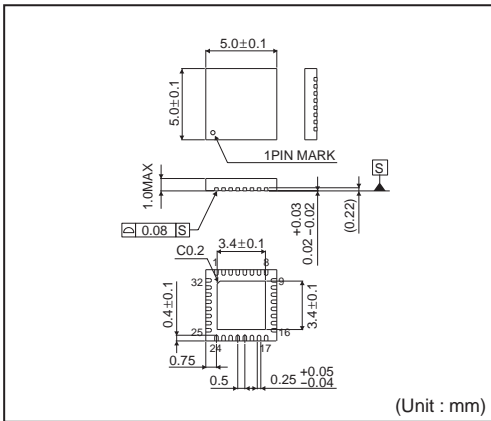

<Tape and Reel information>

Tape	Embossed carrier tape
Quantity	2500pcs
Direction of feed	E2 (The direction is the 1pin of product is at the upper left when you hold reel on the left hand and you pull out the tape on the right hand)

*Order quantity needs to be multiple of the minimum quantity.

●Marking Diagram(s)(TOP VIEW)

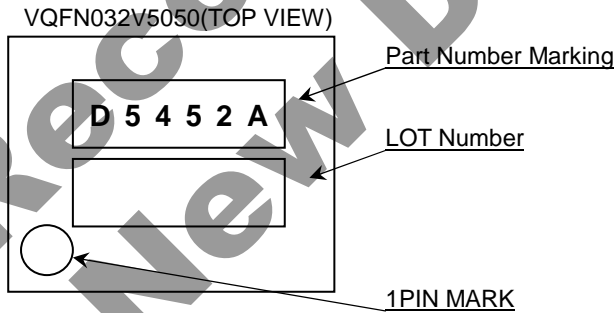

●Revision History

Date	Revision	Changes
04.Oct.2012	001	New Release

**Not Recommended for
New Designs**

Notice

Precaution on using ROHM Products

- Our Products are designed and manufactured for application in ordinary electronic equipments (such as AV equipment, OA equipment, telecommunication equipment, home electronic appliances, amusement equipment, etc.). If you intend to use our Products in devices requiring extremely high reliability (such as medical equipment ^(Note 1), transport equipment, traffic equipment, aircraft/spacecraft, nuclear power controllers, fuel controllers, car equipment including car accessories, safety devices, etc.) and whose malfunction or failure may cause loss of human life, bodily injury or serious damage to property ("Specific Applications"), please consult with the ROHM sales representative in advance. Unless otherwise agreed in writing by ROHM in advance, ROHM shall not be in any way responsible or liable for any damages, expenses or losses incurred by you or third parties arising from the use of any ROHM's Products for Specific Applications.

(Note1) Medical Equipment Classification of the Specific Applications

JAPAN	USA	EU	CHINA
CLASS III	CLASS III	CLASS II b	CLASS III
CLASS IV		CLASS III	

- ROHM designs and manufactures its Products subject to strict quality control system. However, semiconductor products can fail or malfunction at a certain rate. Please be sure to implement, at your own responsibilities, adequate safety measures including but not limited to fail-safe design against the physical injury, damage to any property, which a failure or malfunction of our Products may cause. The following are examples of safety measures:
 - Installation of protection circuits or other protective devices to improve system safety
 - Installation of redundant circuits to reduce the impact of single or multiple circuit failure
- Our Products are designed and manufactured for use under standard conditions and not under any special or extraordinary environments or conditions, as exemplified below. Accordingly, ROHM shall not be in any way responsible or liable for any damages, expenses or losses arising from the use of any ROHM's Products under any special or extraordinary environments or conditions. If you intend to use our Products under any special or extraordinary environments or conditions (as exemplified below), your independent verification and confirmation of product performance, reliability, etc. prior to use, must be necessary:
 - Use of our Products in any types of liquid, including water, oils, chemicals, and organic solvents
 - Use of our Products outdoors or in places where the Products are exposed to direct sunlight or dust
 - Use of our Products in places where the Products are exposed to sea wind or corrosive gases, including Cl₂, H₂S, NH₃, SO₂, and NO₂
 - Use of our Products in places where the Products are exposed to static electricity or electromagnetic waves
 - Use of our Products in proximity to heat-producing components, plastic cords, or other flammable items
 - Sealing or coating our Products with resin or other coating materials
 - Use of our Products without cleaning residue of flux (even if you use no-clean type fluxes, cleaning residue of flux is recommended); or Washing our Products by using water or water-soluble cleaning agents for cleaning residue after soldering
 - Use of the Products in places subject to dew condensation
- The Products are not subject to radiation-proof design.
- Please verify and confirm characteristics of the final or mounted products in using the Products.
- In particular, if a transient load (a large amount of load applied in a short period of time, such as pulse. is applied, confirmation of performance characteristics after on-board mounting is strongly recommended. Avoid applying power exceeding normal rated power; exceeding the power rating under steady-state loading condition may negatively affect product performance and reliability.
- De-rate Power Dissipation (Pd) depending on Ambient temperature (Ta). When used in sealed area, confirm the actual ambient temperature.
- Confirm that operation temperature is within the specified range described in the product specification.
- ROHM shall not be in any way responsible or liable for failure induced under deviant condition from what is defined in this document.

Precaution for Mounting / Circuit board design

- When a highly active halogenous (chlorine, bromine, etc.) flux is used, the residue of flux may negatively affect product performance and reliability.
- In principle, the reflow soldering method must be used; if flow soldering method is preferred, please consult with the ROHM representative in advance.

For details, please refer to ROHM Mounting specification

Precautions Regarding Application Examples and External Circuits

1. If change is made to the constant of an external circuit, please allow a sufficient margin considering variations of the characteristics of the Products and external components, including transient characteristics, as well as static characteristics.
2. You agree that application notes, reference designs, and associated data and information contained in this document are presented only as guidance for Products use. Therefore, in case you use such information, you are solely responsible for it and you must exercise your own independent verification and judgment in the use of such information contained in this document. ROHM shall not be in any way responsible or liable for any damages, expenses or losses incurred by you or third parties arising from the use of such information.

Precaution for Electrostatic

This Product is electrostatic sensitive product, which may be damaged due to electrostatic discharge. Please take proper caution in your manufacturing process and storage so that voltage exceeding the Products maximum rating will not be applied to Products. Please take special care under dry condition (e.g. Grounding of human body / equipment / solder iron, isolation from charged objects, setting of ionizer, friction prevention and temperature / humidity control).

Precaution for Storage / Transportation

1. Product performance and soldered connections may deteriorate if the Products are stored in the places where:
 - [a] the Products are exposed to sea winds or corrosive gases, including Cl₂, H₂S, NH₃, SO₂, and NO₂
 - [b] the temperature or humidity exceeds those recommended by ROHM
 - [c] the Products are exposed to direct sunshine or condensation
 - [d] the Products are exposed to high Electrostatic
2. Even under ROHM recommended storage condition, solderability of products out of recommended storage time period may be degraded. It is strongly recommended to confirm solderability before using Products of which storage time is exceeding the recommended storage time period.
3. Store / transport cartons in the correct direction, which is indicated on a carton with a symbol. Otherwise bent leads may occur due to excessive stress applied when dropping of a carton.
4. Use Products within the specified time after opening a humidity barrier bag. Baking is required before using Products of which storage time is exceeding the recommended storage time period.

Precaution for Product Label

QR code printed on ROHM Products label is for ROHM's internal use only.

Precaution for Disposition

When disposing Products please dispose them properly using an authorized industry waste company.

Precaution for Foreign Exchange and Foreign Trade act

Since our Products might fall under controlled goods prescribed by the applicable foreign exchange and foreign trade act, please consult with ROHM representative in case of export.

Precaution Regarding Intellectual Property Rights

1. All information and data including but not limited to application example contained in this document is for reference only. ROHM does not warrant that foregoing information or data will not infringe any intellectual property rights or any other rights of any third party regarding such information or data. ROHM shall not be in any way responsible or liable for infringement of any intellectual property rights or other damages arising from use of such information or data.:
2. No license, expressly or implied, is granted hereby under any intellectual property rights or other rights of ROHM or any third parties with respect to the information contained in this document.

Other Precaution

1. This document may not be reprinted or reproduced, in whole or in part, without prior written consent of ROHM.
2. The Products may not be disassembled, converted, modified, reproduced or otherwise changed without prior written consent of ROHM.
3. In no event shall you use in any way whatsoever the Products and the related technical information contained in the Products or this document for any military purposes, including but not limited to, the development of mass-destruction weapons.
4. The proper names of companies or products described in this document are trademarks or registered trademarks of ROHM, its affiliated companies or third parties.

General Precaution

1. Before you use our Products, you are requested to carefully read this document and fully understand its contents. ROHM shall not be in any way responsible or liable for failure, malfunction or accident arising from the use of any ROHM's Products against warning, caution or note contained in this document.
2. All information contained in this document is current as of the issuing date and subject to change without any prior notice. Before purchasing or using ROHM's Products, please confirm the latest information with a ROHM sales representative.
3. The information contained in this document is provided on an "as is" basis and ROHM does not warrant that all information contained in this document is accurate and/or error-free. ROHM shall not be in any way responsible or liable for any damages, expenses or losses incurred by you or third parties resulting from inaccuracy or errors of or concerning such information.

**Not Recommended for
New Designs**