

SBS v1.1-COMPLIANT Li-ION GAS-GAUGE IC WITH PROTECTOR INTERFACE

SLUS468E–MAY 2001 – REVISED APRIL 2002

- Provides Accurate Measurement of Available Charge in Li-Ion Batteries
- Supports the 2-Wire SMBus V1.1 Interface With PEC or Single-Wire HDQ16
- Directly Interfaces the Seiko S-8243 Protection IC for Maximum Safety Protection and Minimal Component Count
- Supports Internal or External Thermistor
- Reports Individual Cell Voltages
- Uses 15-Bit ADC for Accurate Voltage, Temperature, and Current Measurements
- Measures Charge Flow Using A V-to-F Converter With Offset of Less Than 16 μ V After Calibration
- Consumes Less Than 0.5 mW Operating
- Drives 4- or 5-Segment LED Display for Remaining Capacity Indication
- 28-Pin 150-Mil SSOP

SSOP (DBQ) PACKAGE
(TOP VIEW)

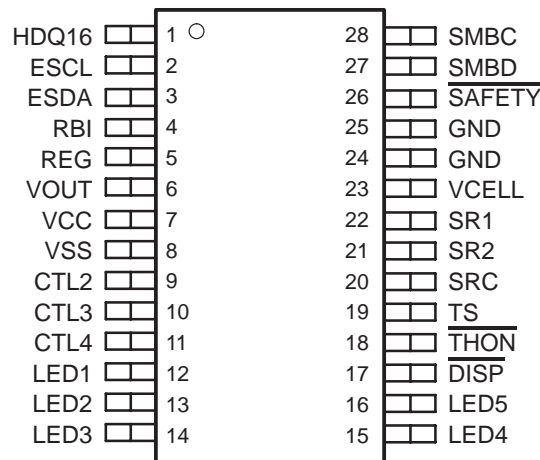

description

The bq2063 SBS-compliant gas gauge IC for battery-pack or in-system installation maintains an accurate record of available charge in Li-Ion batteries. The bq2063 monitors capacity and other critical parameters in Li-Ion battery packs. It also directly interfaces the Seiko S-8243 protection IC to minimize component count in smart-battery circuits.

The bq2063 uses a V-to-F converter with automatic offset correction for charge and discharge counting. For voltage, temperature, and current reporting, the bq2063 uses an A-to-D converter. In conjunction with the S-8243, the onboard ADC also monitors individual cell voltages in a Li-Ion battery pack and allows the bq2063 to generate control signals to enhance pack safety.

The bq2063 supports the smart battery data (SBDData) commands and charge-control functions. It communicates data using the system management bus (SMBus) 2-wire protocol or the 1-wire HDQ16 protocol. The data available include the battery's remaining capacity, temperature, voltage, current, and remaining run-time predictions. The bq2063 provides LED drivers and a push-button input to depict remaining battery capacity from full to empty in 20% or 25% increments with a 4- or 5-segment display.

The bq2063 works with an external EEPROM. The EEPROM stores the configuration information for the bq2063, such as the battery's chemistry, self-discharge rate, rate-compensation factors, measurement calibration, and design voltage and capacity. The bq2063 uses the programmable self-discharge rate and other compensation factors stored in the EEPROM to accurately adjust remaining capacity for use and standby conditions based on time, rate, and temperature. The bq2063 also automatically calibrates or *learns* the true battery capacity in the course of a discharge cycle from programmable near full to near empty levels.

The S-8243 protection IC may be used to provide power to the bq2063 from a 3- or 4-series Li-Ion cell stack.

AVAILABLE OPTIONS

T _J	PACKAGE
	28-LEAD SSOP (DBQ)
-20°C to 70°C	bq2063DBQ



Please be aware that an important notice concerning availability, standard warranty, and use in critical applications of Texas Instruments semiconductor products and disclaimers thereto appears at the end of this data sheet.

PRODUCTION DATA information is current as of publication date. Products conform to specifications per the terms of Texas Instruments standard warranty. Production processing does not necessarily include testing of all parameters.

 **TEXAS
INSTRUMENTS**

POST OFFICE BOX 655303 • DALLAS, TEXAS 75265

Copyright © 2002, Texas Instruments Incorporated

SBS v1.1-COMPLIANT Li-ION GAS-GAUGE IC WITH PROTECTOR INTERFACE

SLUS468E– MAY 2001 – REVISED APRIL 2002

Terminal Functions

TERMINAL NAME	No.	I/O	DESCRIPTION
CTL2–CTL4	9–11	O	3-state outputs to interface the S-8243 protection IC
DISP	17	I	Display control for the LED drivers LED1–LED5
ESCL	2	O	Serial memory clock for data transfer between the bq2063 and the external nonvolatile configuration memory
ESDA	3	I/O	Bidirectional pin that transfers address and data to and from the bq2063 and the external nonvolatile configuration memory
GND	24–25		Must be tied externally to VSS
HDQ16	1	I/O	Serial communication open-drain bidirectional communications port
LED1–LED5	12–16	O	LED display segments that each may drive an external LED
RBI	4	I	Register backup that provides backup potential to the bq2063 registers during periods of low operating voltage. RBI accepts a storage capacitor or a battery input
REG	5	O	Regular output to control an n-JFET for Vcc regulation to the bq2063 from the battery potential
SAFETY	26	O	Open-drain output for an additional level of safety protection (e.g., fuse blow)
SMBC	28	I/O	SMBus clock open-drain bidirectional pin used to clock the data transfer to and from the bq2063
SMBD	27	I/O	SMBus data open-drain bidirectional pin used to transfer address and data to and from the bq2063
SRC	20	I	Current-sense voltage to monitor instantaneous current
SR1–SR2	22–21	I	Connections for a small-value sense resistor to monitor the battery charge- and discharge-current flow
THON	18	O	Control for external FETs to connect the thermistor bias resistor during a temperature measurement
TS	19	I	Thermistor voltage input connection to monitor temperature
VCC	7	I	Supply voltage
VCELL	23	I	Single-cell voltage input that monitors the series element cell voltages from the S-8243
VOUT	6	O	VCC output that supplies power to the external EEPROM configuration memory
VSS	8		Ground

absolute maximum ratings over operating free-air temperature (unless otherwise noted)†

Supply voltage (V_{CC} with respect to V_{SS})	6 V
Input voltage, $V_{(IN)}$, all other pins (all with respect to V_{SS})	6 V
Operating free-air temperature range, T_A	–20°C to 70°C
Storage temperature range, T_{STG}	–20°C to 70°C
Junction temperature range, T_J	–40°C to 125°C
Lead temperature (soldering, 10 s)	300°C

† Stresses beyond those listed under “absolute maximum ratings” may cause permanent damage to the device. These are stress ratings only, and functional operation of the device at these or any other conditions beyond those indicated under “recommended operating conditions” is not implied. Exposure to absolute-maximum-rated conditions for extended periods may affect device reliability.

SBS v1.1-COMPLIANT Li-ION GAS-GAUGE IC WITH PROTECTOR INTERFACE

SLUS468E–MAY 2001 – REVISED APRIL 2002

electrical characteristics for $V_{CC} = 2.7\text{ V to }3.7\text{ V}$, $T_A = -20^\circ\text{C to }70^\circ\text{C}$ (unless otherwise noted)

PARAMETER		TEST CONDITIONS	MIN	TYP	MAX	UNIT	
V_{CC}	Supply voltage		2.7	3.3	3.7	V	
I_{CC}	Operating current	V_{OUT} inactive		180	235	μA	
$I_{(SLP)}$	Low-power storage mode current	$1.5\text{ V} < V_{CC} < 3.7\text{ V}$		5	10	μA	
$I_{(LVOUT)}$	V_{OUT} leakage current	V_{OUT} inactive	-0.2		0.2	μA	
$I_{(VOUT)}$	V_{OUT} source current	V_{OUT} active, $V_{OUT} = V_{CC} - 0.6\text{ V}$	-5			mA	
$V_{I(OLS)}$	Output voltage low: (LED1–LED5, CTL2–4)	$I_{(OLS)} = 5\text{ mA}$			0.4	V	
$V_{(IL)}$	Input voltage low $\overline{\text{DISP}}$		-0.3		0.8	V	
V_{IH}	Input voltage high $\overline{\text{DISP}}$		2		$V_{CC} + 0.3$	V	
V_{OL}	Output voltage low SMBC, SMBD, HDQ16, ESCL, ESDA, THON	$I_{OL} = 1\text{ mA}$			0.4	V	
$V_{(ILS)}$	Input voltage low SMBC, SMBD, HDQ16, ESCL, ESDA		-0.3		0.8	V	
$V_{(IHS)}$	Input voltage high SMBC, SMBD, HDQ16, ESCL, ESDA		1.7		6	V	
$V_{(AI)}$	Input voltage range VCELL, TS, SRC				$V_{SS} - 0.3$	1.25	V
$I_{(RB)}$	RBI data-retention input current	$V_{(RBI)} > 3\text{ V}$, $V_{CC} < 2\text{ V}$		10	50	nA	
$V_{(RBI)}$	RBI data-retention voltage		1.3			V	
$Z_{(AI1)}$	Input impedance SR1, SR2	$0\text{ V} - 1.25\text{ V}$		10		$\text{M}\Omega$	
$Z_{(AI2)}$	Input impedance VCELL, TS, SRC	$0\text{ V} - 1.25\text{ V}$		5		$\text{M}\Omega$	

VFC characteristics, $V_{CC} = 3.1\text{ V to }3.5\text{ V}$, $T_A = 0^\circ\text{C to }70^\circ\text{C}$ (unless otherwise noted)

PARAMETER		TEST CONDITIONS	MIN	TYP	MAX	UNIT
$V_{(SR)}$	Input voltage range, $V_{(SR2)}$ and $V_{(SR1)}$	$V_{SR} = V_{(SR2)} - V_{(SR1)}$	-0.25		0.25	V
$V_{(SROS)}$	Input offset	$V_{(SR2)} = V_{(SR1)}$, autocorrection disabled	-250	-50	250	μV
$V_{(SRCOS)}$	Calibrated offset		-16		16	μV
RM_{VCO}	Supply voltage gain coefficient	$V_{CC} = 3.5\text{ V}$		0.8	1.2	$\%/V$
$RM_{(TCO)}$	Temperature gain coefficient (see Note 1)	Slope for $T_A = -20^\circ\text{C to }70^\circ\text{C}$	-0.09		0.09	$\%/^\circ\text{C}$
		Total Deviation $T_A = -20^\circ\text{C to }70^\circ\text{C}$	-1.6%		0.1%	
		Slope for $T_A = -0^\circ\text{C to }50^\circ\text{C}$	-0.05		0.05	$\%/^\circ\text{C}$
		Total Deviation $T_A = -0^\circ\text{C to }50^\circ\text{C}$	-0.6%		0.1%	
INL	Integral nonlinearity error	$T_A = 0^\circ\text{C to }50^\circ\text{C}$			0.21%	

NOTE 1: $RM_{(TCO)}$ total deviation is from the nominal VFC gain at 25°C .

REG characteristics (see Note 2)

PARAMETER		TEST CONDITIONS	MIN	TYP	MAX	UNIT
$V_{(RO)}$	REG controlled output voltage	JFET: $R_{(ds)(on)} < 150\ \Omega$ $V_{(gs)(off)} \leq -3\text{ V}$ at $10\ \mu\text{A}$	3.1	3.3	3.5	V
I_{REG}	$REG_{(output\ current)}$		1			μA

NOTE 2: Characteristics for internal bq2063 regulator control. Leave REG pin open when using regulated voltage from S-8243.

SBS v1.1-COMPLIANT Li-ION GAS-GAUGE IC WITH PROTECTOR INTERFACE

SLUS468E–MAY 2001 – REVISED APRIL 2002

SMBus ac specifications, $T_A = -20^{\circ}\text{C}$ to 70°C , $2.7\text{ V} < V_{CC} < 3.7\text{ V}$ (unless other noted)

PARAMETER		TEST CONDITIONS	MIN	TYP	MAX	UNIT
F _{SMB}	SMBus operating frequency	Slave mode, SMBC 50% duty cycle	10		100	kHz
F _{MAS}	SMBus master clock frequency	Master mode, no clock low slave extend		51.2		kHz
T _{BUF}	Bus free time between start and stop		4.7			μs
T _{HD:STA}	Hold time after (repeated) start		4.0			μs
T _{SU:STA}	Repeated start setup time		4.7			μs
T _{SU:STO}	Stop setup time		4.0			μs
T _{HD:DAT}	Data hold time	Receive mode	0			μs
		Transmit mode	300			
T _{SU:DAT}	Data setup time		250			μs
T _{TIMEOUT}	Error signal/detect	See Note 3	25		35	ms
T _{LOW}	Clock low period		4.7			μs
T _{HIGH}	Clock high period	See Note 4	4.0		50	μs
T _{LOW:SEXT}	Cumulative clock low slave extend time	See Note 5			25	ms
T _{LOW:MEXT}	Cumulative clock low master extend time	See Note 6			10	ms

- NOTES:
- The bq2063 times out when any clock low exceeds T_{TIMEOUT}
 - T_{HIGH} Max. is minimum bus idle time. SMBC = SMBD = 1 for t > 50 μs causes reset of any transaction involving bq2063 that is in progress.
 - T_{LOW:SEXT} is the cumulative time a slave device is allowed to extend the clock cycles in one message from initial start to the stop.
 - T_{LOW:MEXT} is the cumulative time a master device is allowed to extend the clock cycles in one message from initial start to the stop.

HDQ16 ac specifications, $T_A = -20^{\circ}\text{C}$ to 70°C , $2.7\text{ V} < V_{CC} < 3.7\text{ V}$ (unless otherwise noted)

PARAMETER		TEST CONDITIONS	MIN	TYP	MAX	UNIT
t _{CYCH}	Cycle time, host to bq2063 (write)		190			μs
t _{CYCB}	Cycle time, bq2063 to host (read)		190	205	250	μs
t _{STRH}	Start hold time, host to bq2063 (write)		5			μs
t _{STRB}	Start hold time, bq2063 to host (read)		32			μs
t _{DSU}	Data setup time				50	μs
t _{DSUB}	Data setup time				50	μs
t _(DH)	Data hold time		100			μs
t _{DV}	Data valid time		80			μs
t _{SSU}	Stop setup time				145	μs
t _{SSUB}	Stop setup time				145	μs
t _{RSPS}	Response time, bq2063 to host		190		320	μs
t _B	Break time		190			μs
t _{BR}	Break recovery time		40			μs

Figures 1–4 illustrate the diagrams for the bq2063.

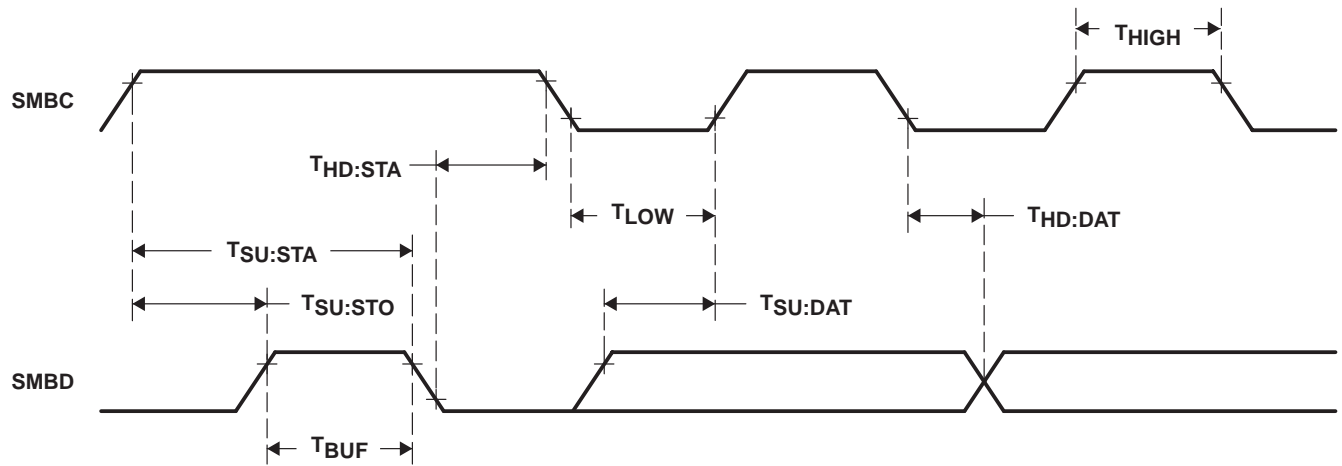

Figure 1. SMBus Timing Data

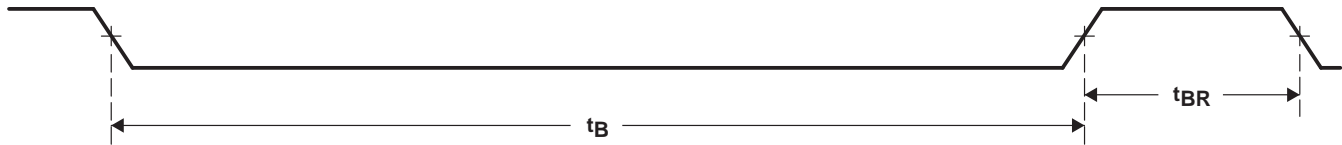

Figure 2. HDQ16 Break Timing

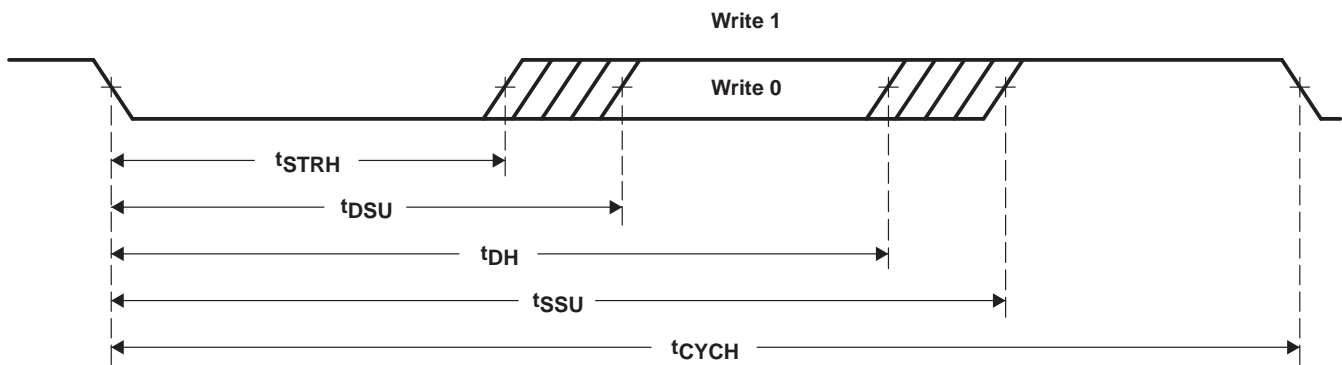

Figure 3. HDQ16 Host to bq2063

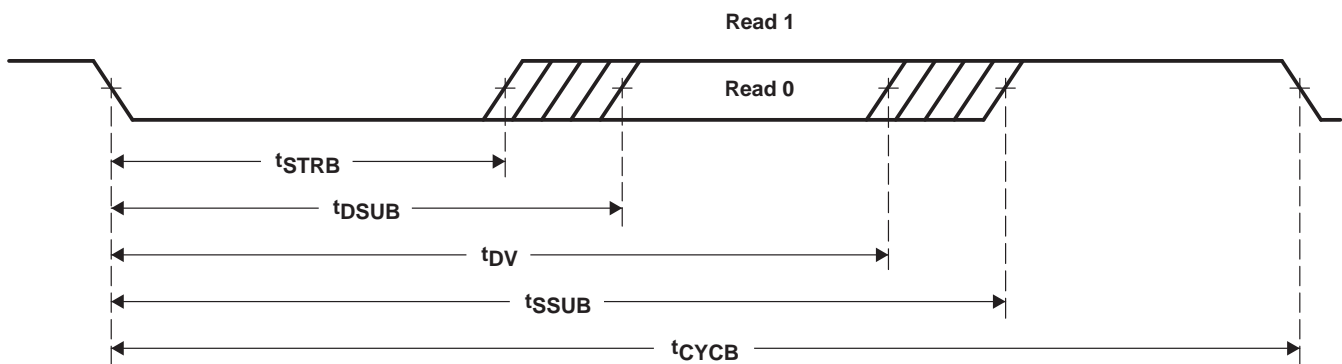

Figure 4. HDQ16 bq2063 to Host

**SBS v1.1-COMPLIANT Li-ION GAS-GAUGE IC
WITH PROTECTOR INTERFACE**SLUS468E–MAY 2001 – REVISED APRIL 2002

functional description**general operation**

The bq2063 determines battery capacity by monitoring the amount of charge input or removed from a rechargeable battery. In addition to measuring charge and discharge, the bq2063 measures battery voltage, temperature, and current, estimates battery self-discharge, and monitors the battery for low-voltage thresholds. The bq2063 measures charge and discharge activity by monitoring the voltage across a small-value series sense resistor between the battery's negative terminal and the negative terminal of the battery pack. The available battery charge is determined by monitoring this voltage and correcting the measurement for environmental and operating conditions.

The bq2063 accepts an NTC thermistor (Semitec 103AT) for temperature measurement or can be configured for internal IC measurement. The bq2063 uses temperature to monitor battery pack and to compensate the self-discharge estimate.

measurements

The bq2063 uses a fully differential, dynamically balanced voltage-to-frequency converter (VFC) for charge measurement and a sigma delta analog-to-digital converter (ADC) for battery voltage, current, and temperature measurement.

Voltage, current, and temperature measurements are made every 2–2.2 seconds, depending on the bq2063 operating mode. Maximum times occur with compensated EDV, mWh mode, and maximum allowable discharge rate. Any AtRate computations requested or scheduled (every 20 seconds) may add up to 0.5 seconds to the time interval.

charge and discharge counting

The VFC measures the charge and discharge flow of the battery by monitoring a small-value sense resistor between the SR1 and SR2 pins as shown in Figure 13. The VFC measures bipolar signals up to 250 mV. The bq2063 detects charge activity when $V_{SR} = V_{(SR2)} - V_{(SR1)}$ is positive and discharge activity when $V_{SR} = V_{(SR2)} - V_{(SR1)}$ is negative. The bq2063 continuously integrates the signal over time using an internal counter. The fundamental rate of the counter is 6.25 μ Vh.

offset calibration

The bq2063 provides an auto-calibration feature to cancel the voltage offset error across SR₁ and SR₂ for maximum charge measurement accuracy. The calibration routine is initiated by issuing a command to ManufacturerAccess(). The bq2063 is capable of automatic offset calibration down to 6.25 μ V. Offset cancellation resolution is less than 1 μ V.

digital filter

The bq2063 does not measure charge or discharge counts below the digital filter threshold. The digital filter threshold is programmed in the EEPROM and should be set sufficiently high to prevent false signal detection with no charge or discharge flowing through the sense resistor.

voltage

While monitoring SR₁ and SR₂ for charge and discharge currents, the bq2063 monitors the battery-pack potential and the individual cell voltages through the VCELL pin. The bq2063 measures the voltage of three or four series elements in a battery pack. CTL3 and CTL4 signal the S-8243 to present the cell voltages at the VCELL input of the bq2063 according to Table 11. The bq2063 calculates the pack voltage and reports the result in Voltage(). The individual cell voltages are stored in the optional manufacturer function area.

functional description (continued)

current

The SRC input of the bq2063 measures battery charge and discharge current. The SRC ADC input converts the current signal from the series sense resistor and stores the result in Current(). The full-scale input range to SBC is limited to ±250 mV.

temperature

The bq2063 can use its internal sensor or an external thermistor to develop the temperature reading, depending on the programming of the EXTH bit in *Pack Configuration*, EE 0x3f.

The TS input of the bq2063 in conjunction with an NTC thermistor measures the battery temperature as shown in Figure 13. The bq2063 reports temperature in Temperature(). $\overline{\text{THON}}$ may be used to switch the bias current through the external thermistor when the bq2063 samples the TS input. $\overline{\text{THON}}$ is low impedance for 60 ms when the temperature is measured, and high impedance otherwise.

gas gauge operation

general

The operational overview in Figure 5 illustrates the gas gauge operation of the bq2063. Table 2 describes the bq2063 registers.

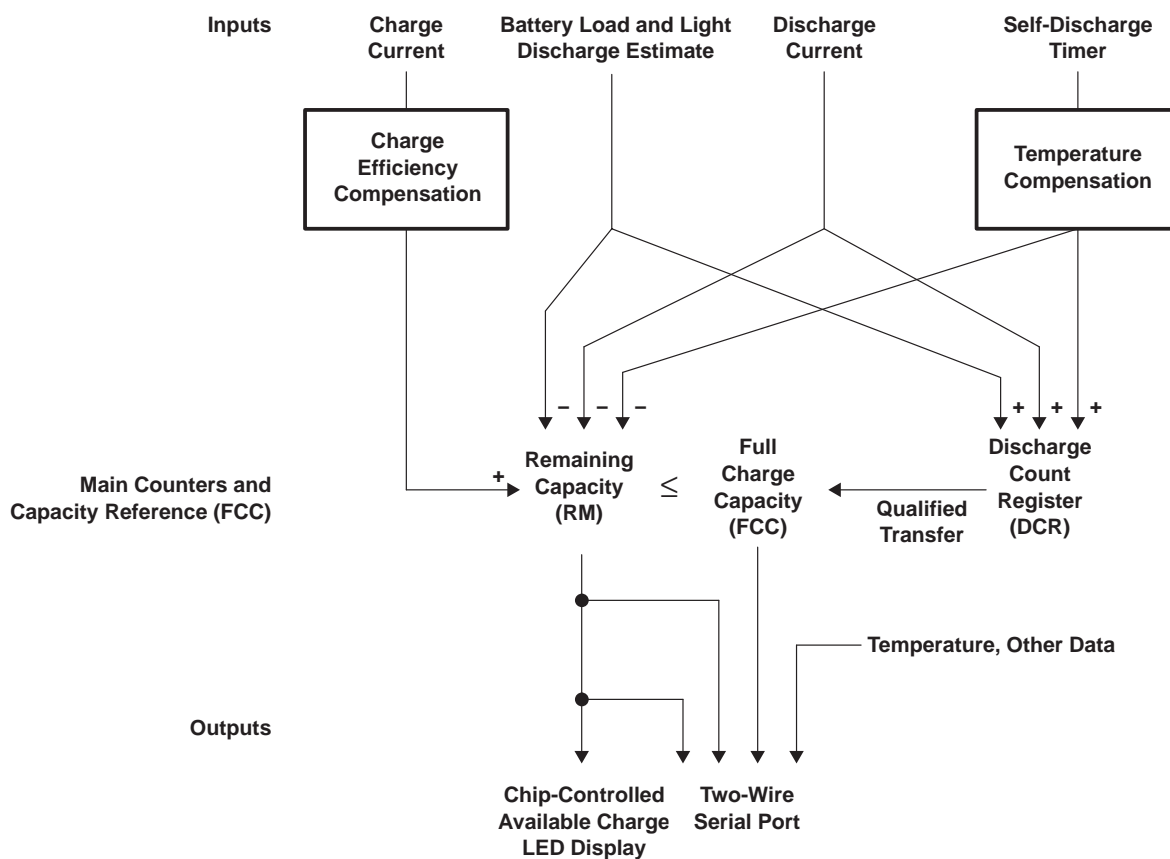

Figure 5. bq2063 Operational Overview

**SBS v1.1-COMPLIANT Li-ION GAS-GAUGE IC
WITH PROTECTOR INTERFACE**SLUS468E–MAY 2001 – REVISED APRIL 2002

general (continued)

The bq2063 accumulates a measure of charge and discharge currents and estimates self-discharge of the battery. The bq2063 compensates the charge current measurement for temperature and state-of-charge of the battery. The bq2063 also adjusts the self-discharge estimation based on temperature.

The main charge counter RemainingCapacity() (RM) represents the available capacity or energy in the battery at any given time. The bq2063 adjusts RM for charge, self-discharge, and leakage compensation factors. The information in the RM register is accessible through the communications ports and is also represented through the LED display.

The FullChargeCapacity() (FCC) register represents the last measured full discharge of the battery. It is used as the battery's full-charge reference for relative capacity indication. The bq2063 updates FCC after the battery undergoes a qualified discharge from nearly full to a low battery level. FCC is accessible through the serial communications ports.

The Discharge Count Register (DCR) is a non-accessible register that tracks discharge of the battery. The bq2063 uses the DCR register to update the FCC register if the battery undergoes a qualified discharge from nearly full to a low battery level. In this way, the bq2063 learns the true discharge capacity of the battery under system use conditions.

main gas-gauge registers

The gas-gauge register functions are described in Table 2.

RemainingCapacity() (RM)

RM represents the remaining capacity in the battery. The bq2063 computes RM in either mAh or 10 mWh depending on the selected mode.

RM counts up during charge to a maximum value of FCC and down during discharge and self-discharge to 0. In addition to charge and self-discharge compensation, the bq2063 calibrates RM at three low-battery-voltage thresholds, EDV2, EDV1, and EDV0 and three programmable midrange thresholds VOC25, VOC50, and VOC75. This provides a voltage-based calibration to the RM counter.

DesignCapacity() (DC)

The DC is the user-specified battery full capacity. It is calculated from *Pack Capacity* EE 0x3a-0x3b and is represented in mAh or 10 mWh. It also represents the full-battery reference for the absolute display mode.

FullChargeCapacity() (FCC)

FCC is the last measured discharge capacity of the battery. It is represented in either mAh or 10 mWh, depending on the selected mode. On initialization, the bq2063 sets FCC to the value stored in *Last Measured Discharge* EE 0x38-0x39. During subsequent discharges, the bq2063 updates FCC with the last measured discharge capacity of the battery. The last measured discharge of the battery is based on the value in the DCR register after a qualified discharge occurs. Once updated, the bq2063 writes the new FCC value to EEPROM in mAh to *Last Measured Discharge*. FCC represents the full battery reference for the relative display mode and relative state of charge calculations.

discharge count register (DCR)

The DCR register counts up during discharge, independent of RM. DCR can continue to count even after RM has counted down to 0. Before RM = 0, discharge activity, light discharge estimation, battery load estimation, and self-discharge increment DCR. After RM = 0, the bq2063 does not apply self-discharge and DCR increments only because of discharge activity, light discharge estimation, and battery load estimation. The bq2063 initializes DCR, at the beginning of a discharge, to FCC – RM when RM is within twice the programmed value in *Near Full* EE 0x55. The DCR initial value of FCC – RM is reduced by FCC/128 if SC = 0 (bit 2 in *Control Mode*) and is not reduced if SC = 1. DCR stops counting when the battery voltage reaches the EDV2 threshold on discharge.

gas gauge operation (continued)**capacity learning (FCC update) and qualified discharge**

The bq2063 updates FCC with an amount based on the value in DCR if a qualified discharge occurs. The new value for FCC equals the DCR value plus the programmable nearly full and low battery levels, according to the following equation:

$$\text{FCC (new)} = \text{DCR (final)} = \text{DCR (initial)} + \text{Measured Discharge to EDV2} + (\text{FCC} \times \text{Battery Low\%}) \quad (1)$$

$$\text{Battery Low \%} = (\text{value stored in EE 0x54}) \div 2.56$$

A qualified discharge occurs if the battery discharges from $\text{RM} \geq \text{FCC} - \text{Near Full} \times 2$ to the EDV2 voltage threshold with the following conditions:

- No valid charge activity occurs during the discharge period. A valid charge is defined as a charge of 10 mAh into the battery.
- No more than 256 mAh of self-discharge, battery load estimation, and/or light discharge estimation occurs during the discharge period.
- The temperature does not drop below the low temperature thresholds programmed in *Max T_LowT* or 12°C during the discharge period. The threshold depends on the programming of the LLTF bit in *Pack Programming*, EE 0x63.
- The battery voltage reaches the EDV2 threshold during the discharge period and the voltage was less than the EDV2 threshold minus 256 mV when the bq2063 detected EDV2.
- No midrange voltage correction occurs during the discharge period.
- Current remains $\geq 3C/32$ or $C/32$, depending on *Pack Programming* selection, when EDV2 or Battery Low % level is reached.

The bq2063 sets VDQ=1 in Pack Status when qualified discharge begins. The bq2063 sets VDQ=0 if any disqualifying condition occurs. FCC cannot be reduced by more than 256 mAh or increased by more than 512 mAh during any single update cycle. The bq2063 saves the new FCC value to the EEPROM within 4 seconds of being updated.

end-of-discharge thresholds and capacity correction

The bq2063 monitors the battery for three low-voltage thresholds, EDV0, EDV1, and EDV2. The EDV thresholds can be programmed for determination based on the overall pack voltage or an individual cell level. The EDVV bit in *Pack Programming* configures the bq2063 for overall voltage or single-cell EDV thresholds. If programmed for single cell EDV determination, the bq2063 determines EDV on the basis of the lowest single-cell voltage. Fixed EDV thresholds may be programmed in *EDVF/EDV0* EE 0x72-0x73, *EMF/EDV1* EE 0x74-0x75, and *EDV C0 Factor/EDV2* EE 0x78-0x79. If the CEDV bit in *Pack Configuration* is set, automatic EDV compensation is enabled and the bq2063 computes the EDV0, EDV1, and EDV2 thresholds based on the values in EE 0x72-0x7d, 0x06, and the battery's current discharge rate and temperature. The bq2063 disables EDV detection if *Current()* exceeds the *Overload Current* threshold programmed in EE 0x46 – EE 0x47. The bq2063 resumes EDV threshold detection after *Current()* drops below the overload current threshold. Any EDV threshold detected is reset after 10 mAh of charge are applied.

SBS v1.1-COMPLIANT Li-ION GAS-GAUGE IC WITH PROTECTOR INTERFACE

SLUS468E– MAY 2001 – REVISED APRIL 2002

end-of-discharge thresholds and capacity correction (continued)

Table 1. State of Charge Based on Low Battery Voltage

THRESHOLD	RELATIVE STATE OF CHARGE
EDV0	0%
EDV1	3%
EDV2	Battery Low %

The bq2063 uses the EDV thresholds to apply voltage-based corrections to the RM register according to Table 1. The bq2063 performs EDV-based RM adjustments with $\text{Current}() \geq C/32$. No EDVs are set if $\text{current} < C/32$. The bq2063 adjusts RM as it detects each threshold. If the voltage threshold is reached before the corresponding capacity on discharge, the bq2063 reduces RM to the appropriate amount as shown in Table 1. This reduction occurs only if $\text{current} \geq C/32$ when the EDV threshold is detected. If RM reaches the capacity level before the voltage threshold is reached on discharge, the bq2063 prevents RM from decreasing further until the battery voltage reaches the corresponding threshold only on a full learning cycle discharge. RM is not held at the associated EDV percentage on a nonlearning discharge cycle ($\text{VDQ}=0$) or if $\text{current} < C/32$.

Table 2. bq2063 Register Functions

FUNCTION	COMMAND CODE		ACCESS (SMBus)	UNITS
	SMBus	HDQ16		
ManufacturerAccess	0x00	0x00	read/write	NA
RemainingCapacityAlarm	0x01	0x01	read/write	mAh, 10 mWh
RemainingTimeAlarm	0x02	0x02	read/write	minutes
BatteryMode	0x03	0x03	read/write	NA
AtRate	0x04	0x04	read/write	mA, 10mW
AtRateTimeToFull	0x05	0x05	read	minutes
AtRateTimeToEmpty	0x06	0x06	read	minutes
AtRateOK	0x07	0x07	read	Boolean
Temperature	0x08	0x08	read	0.1°K
Voltage	0x09	0x09	read	mV
Current	0x0a	0x0a	read	mA
AverageCurrent	0x0b	0x0b	read	mA
MaxError	0x0c	0x0c	read	percent
RelativeStateOfCharge	0x0d	0x0d	read	percent
AbsoluteStateOfCharge	0x0e	0x0e	read	percent
RemainingCapacity	0x0f	0x0f	read	mAh, 10 mWh
FullChargeCapacity	0x10	0x10	read	mAh, 10 mWh
RunTimeToEmpty	0x11	0x11	read	minutes
AverageTimeToEmpty	0x12	0x12	read	minutes
AverageTimeToFull	0x13	0x13	read	minutes
ChargingCurrent	0x14	0x14	read	mA
ChargingVoltage	0x15	0x15	read	mV
Battery Status	0x16	0x16	read	NA
CycleCount	0x17	0x17	read	cycles
DesignCapacity	0x18	0x18	read	mAh, 10 mWh
DesignVoltage	0x19	0x19	read	mV
SpecificationInfo	0x1a	0x1a	read	NA
ManufactureDate	0x1b	0x1b	read	NA

Table 2. bq2063 Register Functions (Continued)

FUNCTION	COMMAND CODE		ACCESS (SMBus)	UNITS
	SMBus	HDQ16		
SerialNumber	0x1c	0x1c	read	integer
Reserved	0x1d-0x1f	0x1d-0x1f	—	—
ManufacturerName	0x20	0x20-0x25	read	string
DeviceName	0x21	0x28-0x2b	read	string
DeviceChemistry	0x22	0x30-0x32	read	string
ManufacturerData	0x23	0x38-0x3b	read	string
Pack Status	0x2f (LSB)	0x2f (LSB)	read/write	NA
Pack Configuration	0x2f (MSB)	0x2f (MSB)	read/write	NA
VCELL4	0x3c	0x3c	read/write	mV
VCELL3	0x3d	0x3d	read/write	mV
VCELL2	0x3e	0x3e	read/write	mV
VCELL1	0x3f	0x3f	read/write	mV

self-discharge

The bq2063 estimates the self-discharge of the battery to maintain an accurate measure of the battery capacity during periods of inactivity. The algorithm for self-discharge estimation takes a programmed estimate for the expected self-discharge rate at 25°C stored in EEPROM and makes a fixed reduction to RM of an amount equal to RemainingCapacity()/256. The bq2063 makes the fixed reduction at a varying time interval that is adjusted to achieve the desired self-discharge rate. This method maintains a constant granularity of 0.39% for each self-discharge adjustment, which may be performed multiple times per day, instead of once per day with a potentially large reduction.

The self-discharge estimation rate for 25°C is doubled for each 10 degrees above 25°C or halved for each 10 degrees below 25°C. The following table shows the relation of the self-discharge estimation at a given temperature to the rate programmed for 25°C (Y% per day).

Table 3. Self-Discharge for Rate Programmed

TEMPERATURE (°C)	SELF-DISCHARGE RATE
Temp < 10	1/4 Y% per day
10 ≤ Temp <20	1/2 Y% per day
20 ≤ Temp <30	Y% per day
30 ≤ Temp <40	2Y% per day
40 ≤ Temp <50	4Y% per day
50 ≤ Temp <60	8Y% per day
60 ≤ Temp <70	16Y% per day
70 ≤ Temp	32Y% per day

The interval at which RM is reduced is given by the following equation, where n is the appropriate factor of 2 (n = 1/4, 1/2, 1, 2, . . .):

$$\text{Self-Discharge Update Time} = \frac{640 \cdot 13500}{256 \cdot n \cdot (\text{Y\% per day})} \text{ seconds} \quad (2)$$

Example: If T = 35°C (n = 2) and programmed self-discharge rate Y is 2.5% per day at 25°C, the bq2063 reduces RM by RM/256 (0.39%) every

$$\frac{640 \cdot 13500}{256 \cdot 2 \cdot 2.5} = 6750 \text{ seconds} \quad (3)$$

SBS v1.1-COMPLIANT Li-ION GAS-GAUGE IC WITH PROTECTOR INTERFACE

SLUS468E– MAY 2001 – REVISED APRIL 2002

self-discharge (continued)

The timer that keeps track of the self-discharge update time is halted whenever charge activity is detected. The timer is reset to zero if the bq2063 reaches the RemainingCapacity()=FullChargeCapacity() condition while charging.

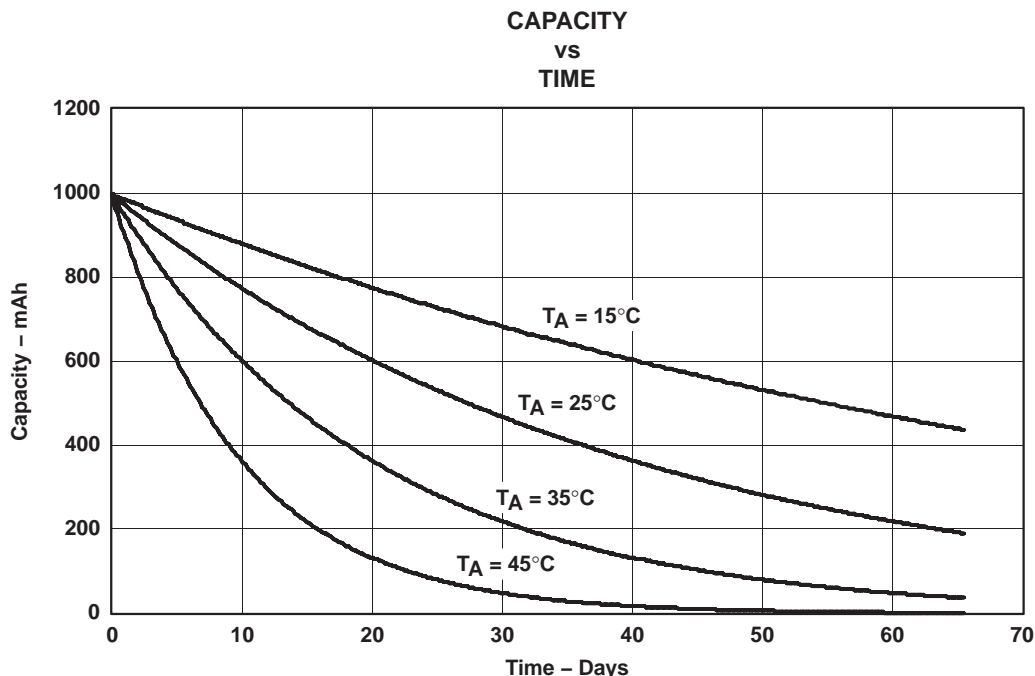

Figure 6. Self-Discharge at 2.5%/Day at 25°C

This means that a 0.39% reduction of RM is made 12.8 times per day to achieve the desired 5% per day reduction at 35°C.

Figure 6 illustrates how the self-discharge estimate algorithm adjusts RemainingCapacity() vs temperature.

light discharge or suspend current compensation

The bq2063 can be configured in two ways to compensate for small discharge currents that produce a signal below the digital filter. First, the bq2063 can decrement RM and DCR at a rate determined by the value stored in *Light Discharge Current* EE 0x64 when it detects no discharge activity and the SMBC and SMBD lines are high. *Light Discharge Current* has a range of 0 mA to 11.2 mA, with 44 μ A granularity.

Alternatively, the bq2063 can be configured to disable the digital filter for discharge when the SMBC and SMBD lines are high. In this way, the digital filter does not mask the leakage-current signal. The bq2063 is configured in this mode by setting the NDF bit in *Control Mode*.

battery electronic load compensation

The bq2063 can be configured to compensate for a constant load present in the battery pack at all times, such as from battery electronics. The bq2063 applies the compensation continuously when the charge or discharge is below the digital filter. The bq2063 applies the compensation in addition to self-discharge. The compensation occurs at a rate determined by the value stored in *Pack Load Estimate* EE 0x1c. The compensation range is 0 μ A–700 μ A in steps of approximately 2.75 μ A.

midrange capacity corrections

The bq2063 applies midrange capacity corrections when the VCOR bit is set in *Pack Configuration*. The bq2063 adjusts RM to the associated percentage at three different voltage levels: VOC25, VOC50, and VOC75. The VOC values represent the open circuit battery voltage at which RM corresponds to the associated for each threshold.

For the midrange corrections to occur, the temperature must be in the range of 19°C to 31°C inclusive and the Current() and AverageCurrent() must both be between –64 mA and 0. The bq2063 makes midrange corrections as shown in Table 4. For a correction to occur, the bq2063 must detect the need for correction twice during subsequent 20-s intervals. With the VCOR bit set, the bq2063 makes mid-range corrections whenever conditions permit. If the OTVC bit in *Pack Configuration* is set and VCOR = 0, the bq2063 makes a single attempt of mid-range correction immediately after device reset and does not require a second validation. The OTVC bit read by command code 0x2f is cleared within 2 seconds after a device reset, when the midrange voltage correction attempt is made.

Table 4. Midrange Corrections

CONDITION		RESULT
Voltage()	\geq VOC75 and RelativeStateOfCharge() \leq 63%	RelativeStateOfCharge() \rightarrow 75%
	$<$ VOC75 and RelativeStateOfCharge() \geq 87%	RelativeStateOfCharge() \rightarrow 75%
	\geq VOC50 and RelativeStateOfCharge() \leq 38%	RelativeStateOfCharge() \rightarrow 50%
	$<$ VOC50 and RelativeStateOfCharge() \geq 62%	RelativeStateOfCharge() \rightarrow 50%
	\geq VOC25 and RelativeStateOfCharge() \leq 13%	RelativeStateOfCharge() \rightarrow 25%
	$<$ VOC25 and RelativeStateOfCharge() \geq 37%	RelativeStateOfCharge() \rightarrow 25%

charge control**charging voltage and current broadcasts**

The bq2063 supports SBS charge control by broadcasting the ChargingCurrent() and ChargingVoltage() to the Smart Charger address. The bq2063 broadcasts the requests every 10 seconds. The bq2063 updates the values used in the charging current and voltage broadcasts based on the battery's state of charge, voltage, and temperature. The charge voltage is programmed in *Charging Voltage* EE 0x0a-0x0b. The charge current may take any of four different values and depends on charge state and operating conditions.

The bq2063 internal charge control is compatible with the constant current/constant voltage profile for Li-Ion. The bq2063 detects primary charge termination on the basis of the tapering charge current during the constant-voltage phase.

alarm broadcasts to smart charger and host

If any of the bits 8–15 in BatteryStatus() are set, the bq2063 broadcasts an AlarmWarning() message to the Host address. If any of the bits 12–15 in BatteryStatus() are set, the bq2063 also sends an AlarmWarning() message to the Smart Charger address. The bq2063 repeats the AlarmWarning() messages every 10 seconds until the alarm bits are cleared.

precharge qualification

The bq2063 sets ChargingCurrent() to the precharge rate as programmed in *Pre-charge Current* EE 0x1e under the following conditions:

- Voltage: The bq2063 requests the precharge charge rate when Voltage() or the lowest cell voltage drops below the EDVF threshold or when the EDV0 threshold is detected. Once requested, a precharge rate remains until Voltage() or the lowest cell voltage increases above the EDVF threshold. The EDVF threshold is programmed in *EDVF/ EDV0* EE 0x72-0x73.

SBS v1.1-COMPLIANT Li-ION GAS-GAUGE IC WITH PROTECTOR INTERFACE

SLUS468E– MAY 2001 – REVISED APRIL 2002

- Temperature: The bq2063 requests the precharge rate when Temperature() is between 0°C and the low temperature fault (LTF) threshold programmed in *MaxT_LowT*. Temperature() must be equal to or greater than the LTF threshold to allow the fast-charge rate. The LTF threshold is programmed in the lower nibble of *MaxT_LowT* EE 0x45.

charge suspension

The bq2063 may temporarily suspend charge if it detects a charging fault. A charging fault includes the following conditions.

- Overcurrent: An overcurrent condition exists when the bq2063 measures the charge current to be more than *Overcurrent Margin* plus *ChargingCurrent*(). *Overcurrent Margin* is programmed in EE 0x49. On detecting an overcurrent condition, the bq2063 sets the *ChargingCurrent*() to zero and sets the *TERMINATE_CHARGE_ALARM* bit in *Battery Status*(). The overcurrent condition and *TERMINATE_CHARGE_ALARM* are cleared when the measured current drops below *Overcurrent Margin*.
- Overvoltage: An overvoltage condition exists when the bq2063 measures the battery voltage to be more than *Overvoltage Margin* plus *ChargingVoltage*(), or when a Li-Ion cell voltage has exceeded the overvoltage limit programmed in *Cell Under/Overvoltage*. *Overvoltage Margin* is programmed in EE 0x48 and *Cell Under/Over Voltage* in EE 0x4a. On detecting an overvoltage condition, the bq2063 sets the *ChargingCurrent*() to zero and sets the *TERMINATE_CHARGE_ALARM* bit in *BatteryStatus*(). The bq2063 clears the *TERMINATE_CHARGE_ALARM* bit when it detects that the battery is no longer being charged (*DISCHARGING* bit set in *BatteryStatus*()). The bq2063 continues to broadcast zero charging current until the overvoltage condition is cleared. The overvoltage condition is cleared when the measured battery voltage drops below the *ChargingVoltage*() plus the *Overvoltage Margin* and all cell voltages are less than the *Cell Under/Over Voltage* threshold.
- Overtemperature: An overtemperature condition exists when Temperature() is greater than or equal to the *Max T* value programmed in EE 0x45 (MSN). On detecting an overtemperature condition, the bq2063 sets the *ChargingCurrent*() to zero and sets the *OVER_TEMP_ALARM* and *TERMINATE_CHARGE_ALARM* bit in *BatteryStatus*() and the *CVOV* bit in *Pack Status*. The overtemperature condition is cleared when Temperature() is equal to or below (*MaxT* –5°C) or 43°C.
- Overcharge: An overcharge condition exists if the battery is charged more than the *Maximum Overcharge* value after *RM = FCC*. *Maximum Overcharge* is programmed in EE 0x2e-0x2f. On detecting an overcharge condition, the bq2063 sets the *ChargingCurrent*() to zero and sets the *OVER_CHARGED_ALARM*, *TERMINATE_CHARGE_ALARM*, and *FULLY_CHARGED* bits in *BatteryStatus*(). The bq2063 clears the *OVER_CHARGED_ALARM* and *TERMINATE_CHARGE_ALARM* when it detects that the battery is no longer being charged. The *FULLY_CHARGED* bit remains set and the bq2063 continues to broadcast zero charging current until *RelativeStateOfCharge*() is less than *Fully Charged Clear%* programmed in EE 0x4c. The counter used to track overcharge capacity is reset with 2 mAh of discharge.
- Undertemperature: An undertemperature condition exists if Temperature() < 0°C. On detecting an undertemperature condition, the bq2063 sets *ChargingCurrent*() to zero. The bq2063 sets *ChargingCurrent*() to the appropriate precharge rate or fast-charge rate when Temperature() ≥ 0°C.

primary charge termination

The bq2063 terminates charge if it detects a charge-termination condition based on current taper. A charge-termination condition includes the following:

For current taper, *ChargingVoltage*() must be set to the pack voltage desired during the constant-voltage phase of charging. The bq2063 detects a current taper termination when the pack voltage is greater than *ChargingVoltage*() minus *Current Taper Qual Voltage* in EE 0x4f and the charging current is below a threshold determined by *Current Taper Threshold* in EE 0x4e, for at least 40 seconds. The bq2063 uses the VFC to measure current for current taper termination. The current must also remain above 0.5625/Rs mA to qualify the termination condition.

primary charge termination (continued)

Once the bq2063 detects a primary charge termination, the bq2063 sets the TERMINATE_CHARGE_ALARM and FULLY_CHARGED bits in BatteryStatus(), and sets the ChargingCurrent() to the maintenance charge rate as programmed in *Maintenance Charging Current* EE 0x1d. On termination, the bq2063 also sets RM to a programmed percentage of FCC, provided that RelativeStateOfCharge() is below the desired percentage of FCC and the CSYNC bit in *Pack Configuration* EE 0x3f is set. The programmed percentage of FCC, *Fast Charge Termination %*, is set in EE 0x4b. The bq2063 clears the FULLY_CHARGED bit when RelativeStateOfCharge() is less than the programmed *Fully Charged Clear %*. The bq2063 broadcasts the fast-charge rate when the FULLY_CHARGED bit is cleared and voltage and temperature permit. The bq2063 clears the TERMINATE_CHARGE_ALARM when it no longer detects that the battery is being charged or it no longer detects the termination condition. See Table 5 for a summary of BatteryStatus() alarm and status bit operation.

Table 5. Alarm and Status Bit Summary

BATTERY STATE	CONDITIONS	CC() CURRENT AND STATUS BITS SET	STATUS CLEAR CONDITION
Overcurrent	$C() \geq CC() + \text{Overcurrent Margin}$	CC() = 0, TCA = 1	$C() < \text{Overcurrent Margin}$
Prolonged overcurrent	$AC() \geq \text{Fast-Charging Current} + \text{Overcurrent Margin}$	CVOV = 1 CC() = 0, TCA = 1	$AC() < 256 \text{ mA}$
Overload	$AC() \leq -\text{Overload Current}$	CVUV = 1	$AC() \geq -256 \text{ mA}$
Overvoltage	$V() \geq CV() + \text{Overvoltage Margin}$ $VCELL1, 2, 3, \text{ or } 4 \geq \text{Cell Over Voltage}$	TCA = 1	DISCHARGING = 1
		CC() = 0, CVOV = 1	$V() < CV() + \text{Overvoltage Margin}$ $VCELL(\text{all}) \leq \text{Cell Over Voltage}$
Overtemperature	$T() \geq \text{Max } T$	CC() = 0, OTA = 1, TCA = 1, CVOV = 1	$T() \leq \text{Max } T - 5^\circ\text{C}$ or $T() \leq 43^\circ\text{C}$
Overcharge	Capacity added after $RM() = FCC() \geq \text{Maximum Overcharge}$	CC() = 0, FC = 1	$RSOC() < \text{Fully Charged Clear \%}$
		OCA = 1, TCA = 1	DISCHARGING = 1
Undertemperature	$T() < 0^\circ\text{C}$	CC() = 0	$0^\circ\text{C} \leq T()$
	$0^\circ\text{C} \leq T() < \text{LTF}$	CC() = Pre-Charge Current	$T() \geq \text{LTF}$
Primary charge termination	Current taper	FC = 1 CC() = Maintenance Charging Current	$RSOC() < \text{Fully Charged Clear \%}$
Fully discharged	$RM() < \text{Battery Low \%}$ and DISCHARGING = 1	FD = 1	$RSOC() \geq 20\%$
Overdischarged	$RM() = 0$ $V() \text{ or } VCELL1, 2, 3, \text{ or } 4 \leq \text{EDV0}$	TDA = 1	$V() \text{ or } VCELL(\text{all}) > \text{EDV0}$ and $RM() > 0$
	$VCELL1, 2, 3 \text{ or } 4 < \text{Cell Under Voltage}$	TDA = 1, CVUV = 1	$V() > \text{EDV0}$ $VCELL(\text{all}) \geq \text{Cell Under Voltage}$
Low capacity	$RM() < \text{RCA}()$	RCA = 1	$RM() \geq \text{RCA}()$
Low run time	$\text{ATTE}() < \text{RTA}()$	RTA = 1	$\text{ATTE}() \geq \text{RTA}()$

NOTE: AC() = AverageCurrent(), C() = Current(), CV() = ChargingVoltage(), CC() = ChargingCurrent(), V() = Voltage(), T() = Temperature(), TCA = TERMINATE_CHARGE_ALARM, OTA = OVER_TEMPERATURE_ALARM, OCA = OVER_CHARGED_ALARM, TDA = TERMINATE_DISCHARGE_ALARM, FC = FULLY_CHARGED, FD = FULLY_DISCHARGED, RSOC() = RelativeStateOfCharge(), RM() = RemainingCapacity(), RCA = REMAINING_CAPACITY_ALARM, RTA = REMAINING_TIME_ALARM, ATTE() = AverageTimeToEmpty(), RTA() = RemainingTimeAlarm(), RCA() = RemainingCapacityAlarm(), LTF = Low Temperature Fault threshold FCC() = Full Charge Capacity

SBS v1.1-COMPLIANT Li-ION GAS-GAUGE IC WITH PROTECTOR INTERFACE

SLUS468E–MAY 2001 – REVISED APRIL 2002

display port

general

The display port drives a 4 or 5 LED bar-graph display. The display is activated by a logic signal on the $\overline{\text{DISP}}$ input. The bq2063 can display RM in either a relative or absolute mode with each LED representing a percentage of the full-battery reference. In relative mode, the bq2063 uses FCC as the full-battery reference; in absolute mode, it uses dc.

The DMODE bit in *Pack Configuration* programs the bq2063 for the absolute or relative display mode. The LED bit in *Control Mode* programs the 4- or 5-LED option. A fifth LED can be used with the 4-LED display option to show when the battery capacity is $\geq 100\%$.

activation

The display may be activated at any time by a high-to-low transition on the $\overline{\text{DISP}}$ input. This is usually accomplished with a pullup resistor and a pushbutton switch. Detection of the transition activates the display and starts a four second display timer. Reactivation of the display requires that the $\overline{\text{DISP}}$ input return to a logic-high state and then transition low again. The second high-to-low transition must occur after the display timer expires. The bq2063 requires the input to remain stable for a minimum of 250 ms to detect the logic state. If unused, the $\overline{\text{DISP}}$ input must be pulled up to V_{CC} .

If the EDV0 bit is set, the bq2063 disables the LED display. The display is also disabled during a VFC calibration and should be turned off before entering low-power storage mode.

display modes

In relative mode, each LED output represents 20% or 25% of the RelativeStateOfCharge() value. In absolute mode, each LED output represents 20% or 25% of the AbsoluteStateOfCharge() value. Table 6 shows the display options for 5 LEDs and Table 7 for 4 LEDs.

In either mode, the bq2063 blinks the LED display if RemainingCapacity() is less than RemainingCapacityAlarm(). The display is disabled if EDV0 = 1.

Table 6. Display Mode for Five LEDs

CONDITION RELATIVE OR ABSOLUTE StateOfCharge()	FIVE LED DISPLAY OPTION				
	LED ₁	LED ₂	LED ₃	LED ₄	LED ₅
EDV0 = 1	OFF	OFF	OFF	OFF	OFF
<20%	ON	OFF	OFF	OFF	OFF
$\geq 20\%$, < 40%	ON	ON	OFF	OFF	OFF
$\geq 40\%$, < 60%	ON	ON	ON	OFF	OFF
$\geq 60\%$, < 80%	ON	ON	ON	ON	OFF
$\geq 80\%$	ON	ON	ON	ON	ON

Table 7. Display Mode for Four LEDs

CONDITION RELATIVE OR ABSOLUTE StateOfCharge()	FOUR LED DISPLAY OPTION			
	LED ₁	LED ₂	LED ₃	LED ₄
EDV0 = 1	OFF	OFF	OFF	OFF
<25%	ON	OFF	OFF	OFF
$\geq 25\%$, < 50%	ON	ON	OFF	OFF
$\geq 50\%$, < 75%	ON	ON	ON	OFF
$\geq 75\%$	ON	ON	ON	ON

Li-Ion protector control

The bq2063 provides a secondary level of protection for lithium ion batteries, as shown in Table 8. The bq2063 uses the CTL2 output to communicate battery conditions to the S-8243A/B Protector IC. When the CVOV or CVUV condition occurs the bq2063 changes the state of the CTL2 pin according to Table 8.

The cell overvoltage threshold should be set higher than the overvoltage threshold of the S-8243 protector, establishing a secondary overvoltage protection limit. The cell undervoltage threshold should be set somewhat higher than the overdischarged threshold of the S-8243 protector, establishing the primary undervoltage limit. There is no secondary undervoltage limit if the cell undervoltage threshold is set lower, because the S-8243 goes into a power-down mode and removes V_{CC} to the bq2063 when it detects the overdischarged limit. It is also recommended that the bq2063 protection control be validated by two successive measurements by setting PDLY=1 in *Pack Programming*.

The bq2063 asserts CVOV to turn off the charge FET if cell overvoltage, battery overvoltage, or overtemperature conditions exist, or if $AverageCurrent() \geq Fast-Charging Current + Overcurrent Margin$ (Prolonged Overcurrent condition in Table 5). It returns control to the S-8243 when overvoltage and overtemperature conditions no longer exist, $AverageCurrent() < 256$ mA (if Prolonged Current generated the fault condition), or $Current() < 0$.

The bq2063 asserts CVUV to turn off the discharge FET if a cell undervoltage condition exists, or if $AverageCurrent() \leq -Overload\ current$ (Overload). It returns control to the S-8243 when the undervoltage condition no longer exists and $AverageCurrent() \geq -256$ mA (if Overload generated the fault condition), or $Current() > 0$.

Table 8. bq2063 to S-8243A/B Interface (FET Protection Control)

Battery State (Table 5)	OUTPUT	INSTRUCTION TO S-8243A/B (CTL1 = LOW)	
	CTL2	DISCHARGING FET	CHARGING FET
CVOV = 1: Prolonged Overcurrent, Overvoltage, Overtemperature	High	Normal (see Note)	Off
CVOV = CVUV = 0	Open	Normal (see Note)	Normal (see Note)
CVUV = 1: Overload, Overdischarged	Low	Off	Normal (see Note)

NOTE: State determined by S-8243A/B

SAFETY output

The \overline{SAFETY} output of the bq2063 provides an additional level of safety control. The active low safety output can be used to blow fuse or control another switch based on temperature or a programmable pack-voltage level. The safety temperature threshold is programmable in *Safety Overtemperature* in EE 0x08 and the voltage level is programmable in *Safety Overvoltage* in EE 0x1f. The bq2063 \overline{SAFETY} is allowed to go low only after the CVOV bit is set 2 seconds before either $Voltage() > Safety\ Overvoltage$ or $Temperature() \geq Safety\ Overtemperature$. If the \overline{SAFETY} output activates, the bq2063 sets the SOV bit in Pack Status. SOV remains set until the bq2063 is reset or the bit is overwritten.

An example circuit using the \overline{SAFETY} output to blow a fuse is shown in Figure 7.

SBS v1.1-COMPLIANT Li-ION GAS-GAUGE IC WITH PROTECTOR INTERFACE

SLUS468E–MAY 2001 – REVISED APRIL 2002

SAFETY output (continued)

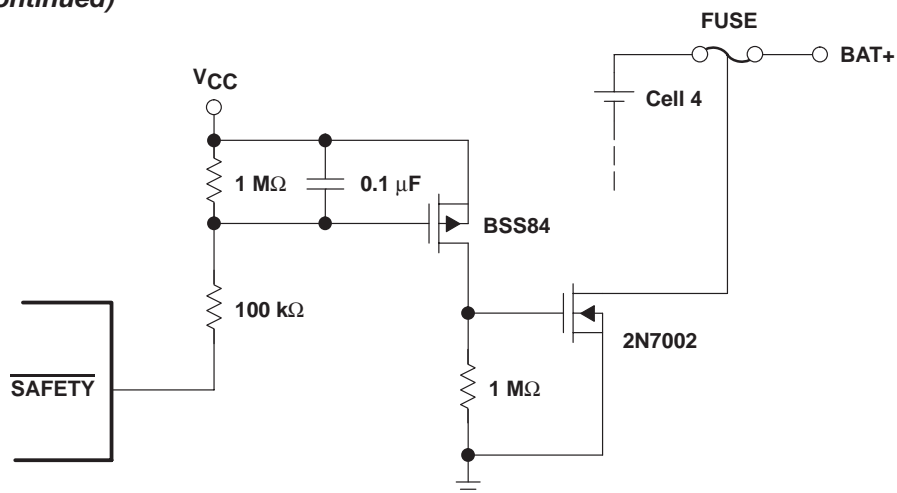

Figure 7. Example SAFETY Circuit Implementation

low-power storage mode

The bq2063 enters low-power mode 5-8 seconds after receiving the Enable Low-Power command. In this mode the bq2063 consumes less than 10 μ A. A rising edge on SMBC, SMBD, or HDQ16 restores the bq2063 to the full operating mode. The bq2063 does not perform any gas-gauge functions during low-power storage mode.

device reset

The bq2063 can be reset with commands over the HDQ16 or SMBus. Upon reset, the bq2063 initializes its internal registers with the information contained in the configuration EEPROM. The following command sequence initiates a full bq2063 reset:

1. Write 0x005a to address 0x4f
2. Write 0x0000 to address 0x7d
3. Write 0x0080 to address 0x7d

A partial reset of the bq2063 occurs if step one is omitted. All initial program values are read from EEPROM for both full and partial resets. A full reset initializes MaxError() = 100%, sets RELEARN_FLAG (bit 7) in BatteryMode, and initializes RM from EEPROM 0x2c–2d. This initial RM value should be programmed to zero for secondary (rechargeable) batteries. A partial reset leaves MaxError(), RELEARN_FLAG, and RM unchanged.

communication

The bq2063 includes two types of communication ports: SMBus and HDQ16. The SMBus interface is a 2-wire bidirectional protocol using the SMBC (clock) and SMBD (data) pins. The HDQ16 interface is a 1-wire bidirectional protocol using the HDQ16 pin. All three communication lines are isolated from VCC and may be pulled-up higher than VCC. Also, the bq2063 does not pull these lines low if VCC to the part is zero. HDQ16 should be pulled down with a 100-k Ω resistor, or may be grounded, if not used.

The communication ports allow a host controller, an SMBus compatible device, or other processor to access the memory registers of the bq2063. In this way a system can efficiently monitor and manage the battery.

SMBus

The SMBus interface is a command-based protocol. A processor acting as the bus master initiates communication to the bq2063 by generating a START condition. A START condition consists of a high-to-low transition of the SMBD line while the SMBC is high. The processor then sends the bq2063 device address of

0001011 (bits 7-1) plus a R/W bit (bit 0) followed by an SMBus command code. The R/W bit (LSB) and the command code instruct the bq2063 to either store the forthcoming data to a register specified by the SMBus command code or output the data from the specified register. The processor completes the access with a STOP condition. A STOP condition consists of a low-to-high transition of the SMBD line while the SMBC is high. With SMBus, the most-significant bit (MSB) of a data byte is transmitted first.

In some instances, the bq2063 acts as the bus master. This occurs when the bq2063 broadcasts charging requirements and alarm conditions to device addresses 0x12 (SBS Smart Charger) and 0x10 (SBS Host Controller.)

SMBus protocol

The bq2063 supports the following SMBus protocols:

- Read Word
- Write Word
- Block Read

A processor acting as the bus master uses the three protocols to communicate with the bq2063. The bq2063 acting as the bus master uses the Write Word protocol.

The SMBD and SMBC pins are open drain and require external pullup resistors. If detection of an SMBus Off State is required when the SMBC and SMBD lines are open, a 1-M Ω pulldown resistor in the battery pack is recommended.

SMBus packet error checking

The bq2063 supports Packet Error Checking as a mechanism to confirm proper communication between it and another SMBus device. Packet Error Checking requires that both the transmitter and receiver calculate a Packet Error Code (PEC) for each communication message. The device that supplies the last byte in the communication message appends the PEC to the message. The receiver compares the transmitted PEC to its PEC result to determine if there is a communication error.

PEC protocol

The bq2063 can receive or transmit data with or without PEC. Figure 8 shows the communication protocol for the Read Word, Write Word, and Read Block messages without PEC. Figure 8 includes PEC.

In the Write Word protocol, the bq2063 receives the PEC after the last byte of data from the host. If the host does not support PEC, the last byte of data is followed by a STOP condition. After receipt of the PEC, the bq2063 compares the value to its calculation. If the PEC is correct, the bq2063 responds with an ACKNOWLEDGE. If it is not correct, the bq2063 responds with a NOT ACKNOWLEDGE and sets an error code.

In the Read Word and Block Read, the host generates an ACKNOWLEDGE after the last byte of data sent by the bq2063. The bq2063 then sends the PEC and the host acting as a master-receiver generates a NOT ACKNOWLEDGE and a STOP condition.

SBS v1.1-COMPLIANT Li-ION GAS-GAUGE IC
WITH PROTECTOR INTERFACE

SLUS468E- MAY 2001 - REVISED APRIL 2002

PEC protocol (continued)

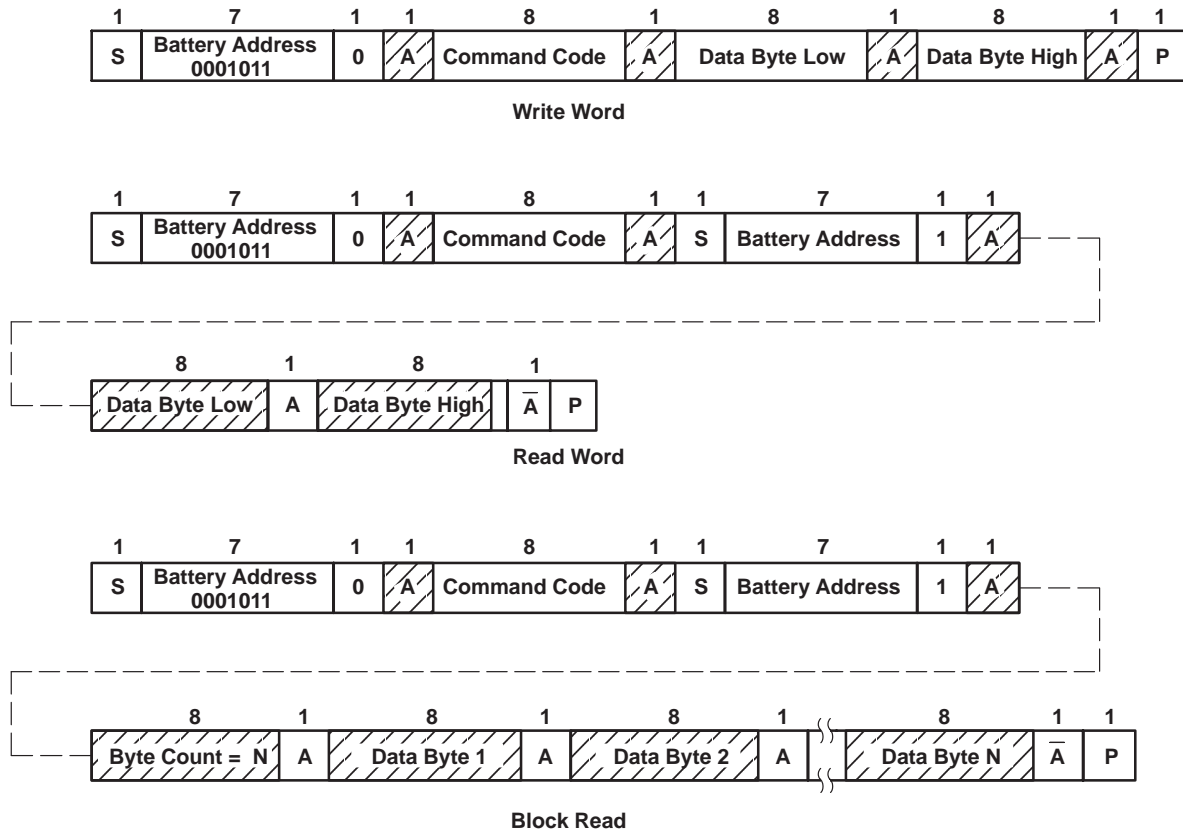

Figure 8. SMBus Communication Protocol Without PEC

PEC protocol (continued)

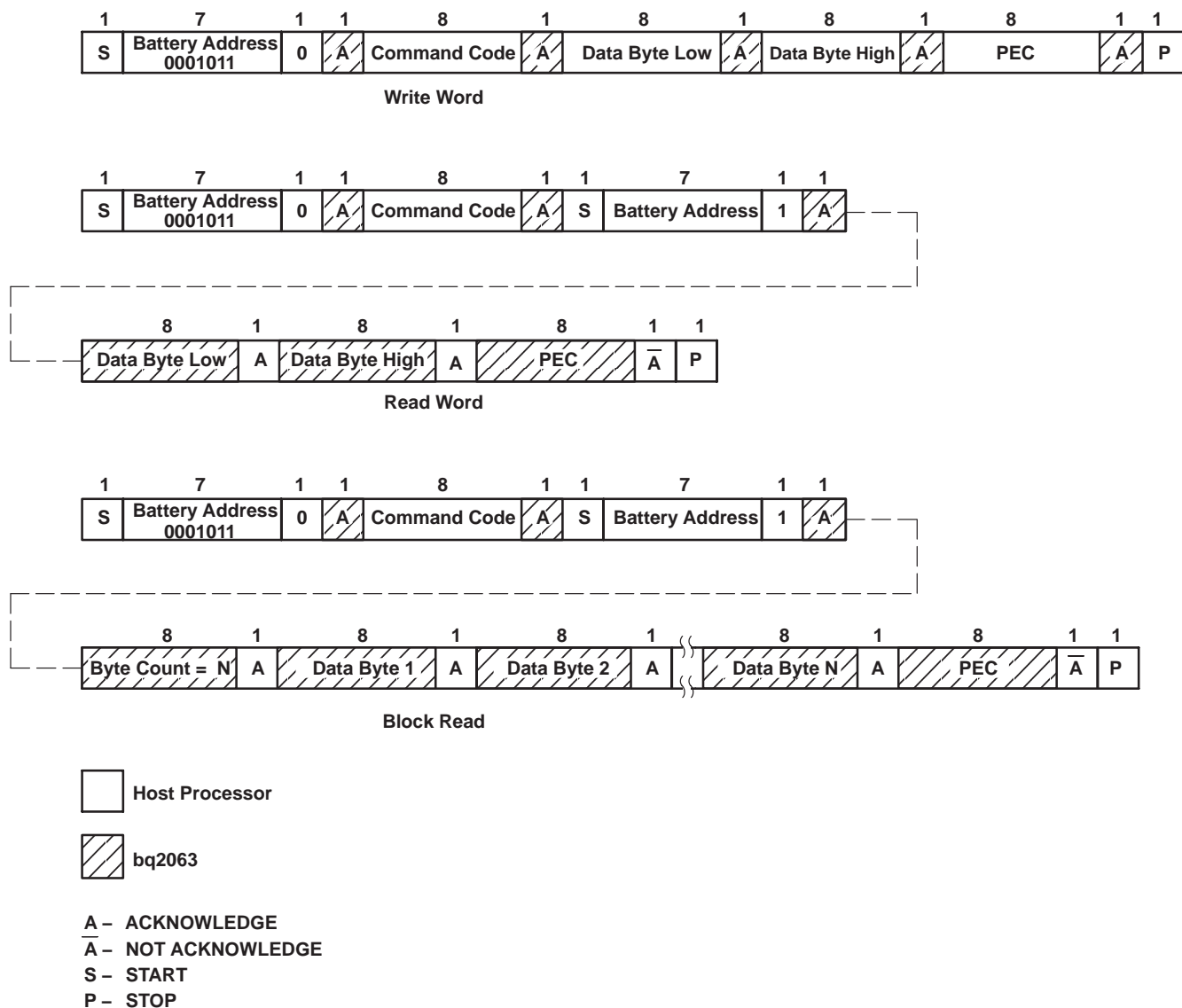

Figure 9. SMBus Communication Protocol With PEC

PEC calculation

The basis of the PEC calculation is an 8-bit Cyclic Redundancy Check (CRC-8) based on the polynomial $C(X) = X^8 + X^2 + X^1 + 1$. The PEC calculation includes all bytes in the transmission, including address, command, and data. The PEC calculation does not include ACKNOWLEDGE, NOT ACKNOWLEDGE, START, STOP, and Repeated START bits.

For example, the host requests RemainingCapacity() from the bq2063. This includes the host following the Read Word protocol. The bq2063 calculates the PEC based on the following 5 bytes of data, assuming the remaining capacity of the battery is 1001 mAh.

- Battery Address with $R/\bar{W} = 0$: 0x16
- Command Code for RemainingCapacity(): 0x0f
- Battery Address with $R/\bar{W} = 1$: 0x17

SBS v1.1-COMPLIANT Li-ION GAS-GAUGE IC WITH PROTECTOR INTERFACE

SLUS468E–MAY 2001 – REVISED APRIL 2002

- RemainingCapacity(): 0x03e9

For 0x160f17e903, the bq2063 transmits a PEC of 0xe8 to the host.

PEC enable in master mode

PEC for master mode broadcasts to the charger, host, or both can be enabled/disabled with the combination of the bits HPE and CPE in *Control Mode*.

SMBus on and off state

The bq2063 detects whether the SMBus enters the Off State by monitoring the SMBC and SMBD lines. When both signals are continually low for at least 2.5 s, the bq2063 detects the Off State. When the SMBC and SMBD lines go high, the bq2063 detects the On State and can begin communication within 1 ms. One-M Ω pulldown resistors on SMBC and SMBD are recommended for reliable Off State detection.

HDQ16

The HDQ16 interface is a command-based protocol. (See Figure 10.) A processor sends the command code to the bq2063. The 8-bit command code consists of two fields: the 7-bit HDQ16 command code (bits 0-6) and the 1-bit R/W field (MSB bit 7). The R/W field directs the bq2063 either to

- Store the next 16 bits of data to a specified register or
- Output 16 bits of data from the specified register

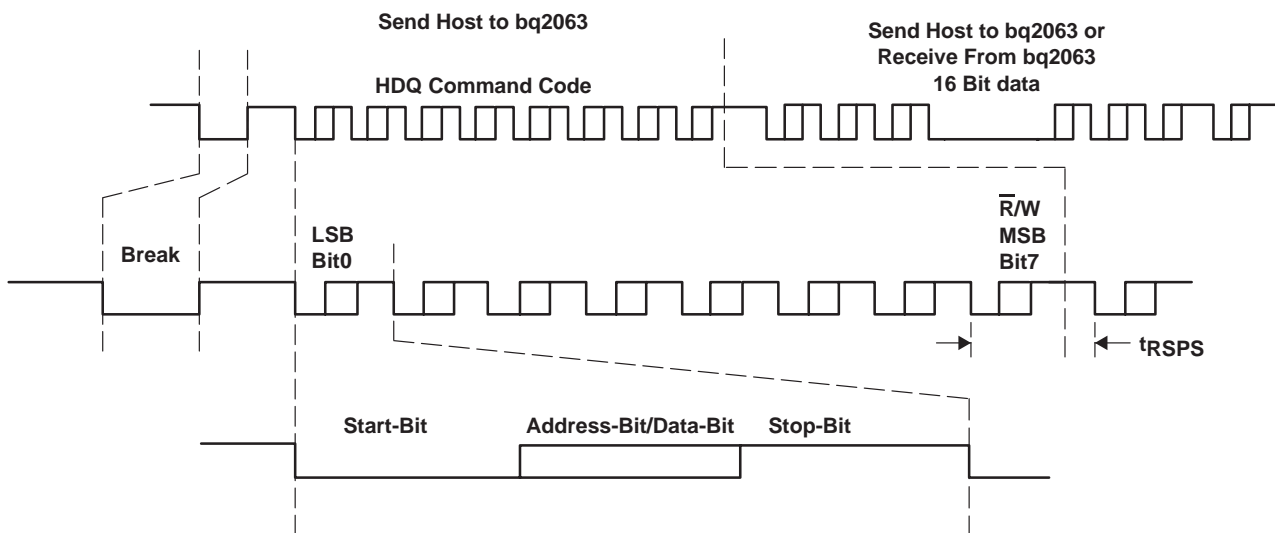

Figure 10. HDQ16 Communication Example

With HDQ16, the least significant bit (LSB) of a data byte (command) or word (data) is transmitted first.

A bit transmission consists of three distinct sections. The first section starts the transmission by either the host or the bq2063 taking the HDQ16 pin to a logic-low state for a period $t_{STRH;B}$. The next section is the actual data-transmission, where the data bit is valid by the time $t_{DSU;B}$ after the negative edge used to start communication. The data bit is held for a period $t_{(DH;DV)}$ to allow the host processor or bq2063 to sample the data bit.

The final section is used to stop the transmission by returning the HDQ16 pin to a logic-high state by at least the time t_{SSUB} after the negative edge used to start communication. The final logic-high state should continue for a period $t_{CYCH;B}$ to allow time to ensure that the bit transmission was stopped properly.

If a communication error occurs (e.g., $t_{CYCB} > 250 \mu\text{s}$), the host sends the bq2063 a BREAK to reinitiate the serial interface. The bq2063 detects a BREAK when the HDQ16 pin is in a logic-low state for a time t_B or greater. The HDQ16 pin is then returned to its normal ready high-logic state for a time t_{BR} . The bq2063 is then ready to receive a command from the host processor.

The HDQ16 pin is open drain and requires an external pullup resistor.

Figure 2 shows the HDQ16 break timing for the bq2063.

command codes

The SMBus command codes are in (), the HDQ16 in []. Temperature(), Voltage(), Current(), and AverageCurrent(), performance specifications are at regulated V_{CC} ($V_{(RO)}$) and a temperature of 0-70°C.

ManufacturerAccess() (0x00); [0x00-0x01]

Description: This function provides writable command codes to control the bq2063 during normal operation and pack manufacture. These commands may be ignored if sent within one second of a device reset. The following commands are available:

0x0618 Enable Low-Power Storage Mode activates the low-power storage mode. The bq2063 enters the storage mode after a 5-8 second delay. The bq2063 accepts other commands to ManufacturerAccess() during the delay before entering low-power storage mode. The LEDs must be off before entering the low-power storage mode as the display state remains unchanged.

The bq2063 clears the ManufacturerAccess() command within 900ms of acknowledging the Enable Low-Power Storage command. During the delay following the low-power storage command, a VFC Calibration command may be issued. The VFC Calibration command must be sent 900-5000ms after SMBus acknowledgment of the Enable Low-Power Storage command. The bq2063 delays entering storage mode until the calibration process completes and the bq2063 stores the new calibration values in EEPROM.

0x062b SEAL instructs the bq2063 to restrict access to those functions listed in Table 3. Note: The SEAL command does not change the state of the SEAL bit in *Pack Configuration* in EEPROM. The bq2063 completes the seal function and clears ManufacturerAccess() within 900 ms of acknowledging the command.

0x064d Charge Synchronization instructs the bq2063 to update RM to a percentage of FCC as defined in *Fast Charge Termination %*. The bq2063 updates RM and clears ManufacturerAccess() within 900ms of acknowledging the command.

0x0653 Enable VFC Calibration instructs the unsealed bq2063 to begin VFC calibration. With this command the bq2063 deselects the SR₁ and SR₂ inputs and calibrates for IC offset only. It is best to avoid charge or discharge currents through the sense resistor during this calibration process.

0x067e Alternate VFC Calibration instructs the unsealed bq2063 to begin VFC calibration. With this command the bq2063 does not deselect the SR₁ and SR₂ inputs and does calibrate for IC and PCB offset. During this procedure no charge or discharge currents must flow through the sense resistor.

During VFC calibration, the bq2063 disables the LED display and accepts only the Enable Low-Power Storage mode, the Stop VFC Calibration, and the SEAL commands to ManufacturerAccess(). The bq2063 disregards all other commands. SMBus communication should be kept to a minimum during VFC calibration to reduce the noise level and allow a more accurate calibration.

Once started, the VFC calibration procedure completes automatically. When complete, the bq2063 saves the calibration values in EEPROM. The calibration normally takes about 8 to 10 minutes. The calibration time is inversely proportional to the bq2063 VFC (and PCB) offset error. The bq2063 caps the calibration time at one hour in the event of calibrating zero offset error. The VFC calibration can be done as the last step in a battery pack test procedure since the calibration can complete automatically after removal from a test setup.

The bq2063 clears ManufacturerAccess() within 900 ms and starts calibration within 3.2 seconds of acknowledging the command.

**SBS v1.1-COMPLIANT Li-ION GAS-GAUGE IC
WITH PROTECTOR INTERFACE**SLUS468E– MAY 2001 – REVISED APRIL 2002

0x0660 Stop VFC Calibration instructs the bq2063 to abort a VFC calibration procedure. If aborted, the bq2063 disables offset correction. The bq2063 stops calibration within 20 ms of acknowledging the command.

0x0606 Program EEPROM instructs the unsealed bq2063 to connect the SMBus to the EEPROM I2C bus. The bq2063 applies power to the EEPROM within 900 ms of acknowledging the command. After issuing the program EEPROM command, the bq2063 monitoring functions are disabled until the I2C bus is disconnected. The bq2063 disconnects the I2C bus when it detects that the Battery Address 0x16 is sent over the SMBus. The Battery Address 0x16 to disconnect the I2C bus should not be sent until 10 ms after the last write to the EEPROM.

0x07e6 Device Revision instructs the bq2063 to return the device revision level to `ManufactureAccess()` so it may be read.

Purpose: The `ManufactureAccess()` function provides the system host access to bq2063 functions that are not defined by the SBD.

SMBus Protocol: Read or Write Word

Input/Output: Word

Example:

The following sequence of actions is an example of how to use the `ManufactureAccess()` commands efficiently to take a battery pack that has completed all testing and calibration except for VFC calibration and to make it ready for shipment in the SEALED state and in low-power storage mode:

1. Complete testing, programming, and calibration with desired final values stored in EEPROM with the SEAL bit not set. Sending a reset command to the bq2063 during test ensures that RAM values correspond to the final EEPROM values.
2. If the initial value of `RemainingCapacity()` must be nonzero, the desired value may be written to command 0x26.
3. Issue the Program EEPROM command and set the SEAL bit in EEPROM.
4. Issue the Enable VFC (or Alternate VFC) Calibration command. The bq2063 resets the OCE bit in Pack Status when calibration begins and sets the bit when calibration successfully completes and the calibration values have been written to EEPROM.
5. Issue the Enable Low-Power Storage Mode command. This must be done before VFC offset calibration completes.
6. Issue the SEAL command. This must be done before VFC offset calibration completes.

After VFC calibration completes automatically, the bq2063 saves the VFC offset cancellation values in EEPROM and then enters the low-power storage mode after about 20 seconds. In addition, the bq2063 is sealed, allowing access only as defined in Table 2.

RemainingCapacityAlarm() (0x01); [0x01]

Description: Sets or gets the low-capacity threshold value. Whenever the RemainingCapacity() falls below the low capacity value, the bq2063 sends AlarmWarning() messages to the SMBus Host with the REMAINING_CAPACITY_ALARM bit set. A low-capacity value of 0 disables this alarm. The bq2063 initially sets the low-capacity value to *Remaining Capacity Alarm* value programmed in EE 0x04–0x05. The low-capacity value remains unchanged until altered by the RemainingCapacityAlarm() function. The low-capacity value may be expressed in either current (mA) or power (10 mWh) depending on the setting of the BatteryMode() CAPACITY_MODE bit.

Purpose: The RemainingCapacityAlarm() function can be used by systems that know how much power they require to save their operating state. It enables those systems to more finely control the point at which they transition into suspend or hibernate state. The low-capacity value can be read to verify the value in use by the bq2063's low capacity alarm.

SMBus Protocol: Read or Write Word

Input/Output: Unsigned integer-value below which Low Capacity messages are sent.

	BATTERY MODES	
	CAPACITY_MODE BIT = 0	CAPACITY_MODE BIT = 1
Units	mAh at C/5	10 mWh at P/5
Range	0–65,535 mAh	0–65,535 10 mWh
Granularity	Not applicable	
Accuracy	See RemainingCapacity()	

Description: Sets or gets the remaining time alarm value. Whenever the AverageTimeToEmpty() falls below the remaining time value, the bq2063 sends AlarmWarning() messages to the SMBus Host with the REMAINING_TIME_ALARM bit set. A remaining time value of 0 effectively disables this alarm. The bq2063 initially sets the remaining time value to the *Remaining Time Alarm* value programmed in EE 0x02–0x03. The remaining time value remains unchanged until altered by the RemainingTimeAlarm() function.

Purpose: The RemainingTimeAlarm() function can be used by systems that want to adjust when the remaining time alarm warning is sent. The remaining time value can be read to verify the value in use by the bq2063 RemainingTimeAlarm().

SMBus Protocol: Read or Write Word

Input/Output: Unsigned integer—the point below which remaining time messages are sent.

Units: minutes

Range: 0 to 65,535 minutes

Granularity: Not applicable

Accuracy: see AverageTimeToEmpty()

BatteryMode() (0x03); [0x03]

Description: Selects the various battery operational modes and reports the battery's mode and requests.

Defined modes include

- Whether the battery's capacity information is specified in mAh or 10 mWh (CAPACITY_MODE bit)
- Whether the ChargingCurrent() and ChargingVoltage() values are broadcast to the Smart Battery Charger when the bq2063 detects the battery requires charging (CHARGER_MODE bit)
- Whether all broadcasts to the Smart Battery Charger and Host are disabled

SBS v1.1-COMPLIANT Li-ION GAS-GAUGE IC WITH PROTECTOR INTERFACE

SLUS468E–MAY 2001 – REVISED APRIL 2002

command codes (continued)

The defined request condition is the battery requesting a conditioning cycle (RELEARN_FLAG).

Purpose: The CAPACITY_MODE bit allows power management systems to best match their electrical characteristics with those reported by the battery. For example, a switching power supply represents a constant power load, whereas a linear supply is better represented by a constant current model. The CHARGER_MODE bit allows a SMBus Host or Smart Battery Charger to override the Smart Battery's desired charging parameters by disabling the bq2063's broadcasts. The RELEARN_FLAG bit allows the bq2063 to request a conditioning cycle.

SMBus Protocol: Read or Write Word

Input/Output: Unsigned integer—bit mapped— see below.

Units: not applicable

Range: 0-1

Granularity: not applicable

Accuracy: not applicable

The BatteryMode() word is divided into two halves, the MSB (bits 8-15) which is read/write and the LSB (bits 0-7) which is read only. The bq2063 forces bits 0-6 to zero and prohibits writes to bit 7.

Table 9 summarizes the meanings of the individual bits in the BatteryMode() word and specifies the default values, where applicable, are noted.

INTERNAL_CHARGE_CONTROLLER bit is not used by the bq2063.

PRIMARY_BATTERY_SUPPORT bit is not used by the bq2063.

RELEARN_FLAG bit set indicates that the bq2063 is requesting a capacity relearn cycle for the battery. The bq2063 sets the RELEARN_FLAG on a full reset and if it detects 20 cycle counts without an FCC update. The bq2063 clears this flag after a learning cycle has been completed.

CHARGE_CONTROLLER_ENABLED bit is not used by the bq2063. The bq2063 forces this bit to zero.

PRIMARY_BATTERY bit is not used by the bq2063. The bq2063 forces this bit to zero.

Table 9. Battery Mode Bits and Values

Battery Mode() BITS	BITS USED	FORMAT	ALLOWABLE VALUES
INTERNAL_CHARGE_CONTROLLER	0	Read only bit flag	
PRIMARY_BATTERY_SUPPORT	1	Read only bit flag	
Reserved	2–6		
RELEARN_FLAG	7	Read only bit flag	0—Battery OK 1—Relearn cycle requested
CHARGE_CONTROLLER_ENABLED	8	R/W bit flag	
PRIMARY_BATTERY	9	R/W bit flag	
Reserved	10–12		
ALARM_MODE	13	R/W bit flag	0—Enable alarm broadcast (default) 1—Disable alarm broadcast
CHARGER_MODE	14	R/W bit flag	0—Enable charging broadcast (default) 1—Disable charging broadcast
CAPACITY_MODE	15	R/W bit flag	0—Report in mA or mAh (default) 1—Report in 10mW or 10 mWh

command codes (continued)

ALARM_MODE bit is set to disable the bq2063's ability to master the SMBus and send AlarmWarning() messages to the SMBus Host and the Smart Battery Charger. When set, the bq2063 does *not* master the SMBus, and AlarmWarning() messages are not sent to the SMBus Host and the Smart Battery Charger for a period of no more than 65 seconds and no less than 45 seconds. When cleared (default), the Smart Battery sends the AlarmWarning() messages to the SMBus Host and the Smart Battery Charger any time an alarm condition is detected.

- The bq2063 polls the ALARM_MODE bit at least every 150 ms. Whenever the ALARM_MODE bit is set, the bq2063 resets the bit and starts or restarts a 55 seconds (nominal) timer. After the timer expires, the bq2063 automatically enables alarm broadcasts to ensure that the accidental deactivation of broadcasts does not persist. An SMBus host that does not want the bq2063 to be a master on the SMBus must therefore continually set this bit at least once per 50 seconds to keep the bq2063 from broadcasting alarms.
- The ALARM_MODE bit defaults to a cleared state within 130 ms after the bq2063 detects the SMBus Off-State.
- The condition of the ALARM-MODE bit does *not* affect the operation or state of the CHARGER_MODE bit which is used to prevent broadcasts of ChargingCurrent() and ChargingVoltage() to the Smart Battery Charger.

CHARGER_MODE bit enables or disables the bq2063's transmission of ChargingCurrent() and ChargingVoltage() messages to the Smart Battery Charger. When set, the bq2063 does *not* transmit ChargingCurrent() and ChargingVoltage() values to the Smart Battery Charger. When cleared, the bq2063 transmits the ChargingCurrent() and ChargingVoltage() values to the Smart Battery Charger. The CHARGER_MODE bit defaults to a cleared state within 130 ms after the bq2063 detects the SMBus Off-State.

CAPACITY_MODE bit indicates if capacity information is reported in mA/mAh or 10mW/10 mWh. When set, the bq2063 reports capacity information in 10 mW/10 mWh as appropriate. When cleared, the bq2063 reports capacity information in mA/mAh as appropriate. The CAPACITY_MODE bit defaults to a cleared state within 130 ms after the bq2063 detects the SMBus Off-State.

The following functions are changed to accept or return values in mA/mAh or 10 mW/10 mWh depending on the CAPACITY_MODE bit:

- RemainingCapacityAlarm()
- AtRate()
- RemainingCapacity()
- FullChargeCapacity()
- DesignCapacity()

The following functions are calculated on the basis of capacity and may be calculated differently depending on the CAPACITY_MODE bit:

- AtRateOK()
- AtRateTimeToEmpty()
- AtRateTimeToFull()
- RunTimeToEmpty()
- AverageTimeToEmpty()
- AverageTimeToFull()
- Remaining Time Alarm()
- BatteryStatus()

SBS v1.1-COMPLIANT Li-ION GAS-GAUGE IC WITH PROTECTOR INTERFACE

SLUS468E– MAY 2001 – REVISED APRIL 2002

command codes (continued)

The bq2063 updates the non-AtRate related register values within 3 seconds of changing the state of the CAPACITY_MODE bit. The AtRate() values are updated after the next AtRate value is written to the bq2063 (or after the next 20 seconds scheduled refresh calculation).

AtRate() (0x04); [0x04]

Description: The AtRate() function is the first half of a two-function call-set used to set the AtRate value used in calculations made by the AtRateTimeToFull(), AtRateTimeToEmpty(), and AtRateOK() functions. The AtRate value may be expressed in either current (mA) or power (10 mW) depending on the setting of the BatteryMode() CAPACITY_MODE bit.

Purpose: Since the AtRate() function is the first half of a two-function call-set, it is followed by the second function of the call-set that calculates and returns a value based on the AtRate value and the battery's present state. A delay of up to 1.3 seconds is required after writing AtRate() before the bq2063 can acknowledge the requested AtRate function.

- When the AtRate() value is positive, the AtRateTimeToFull() function returns the predicted time to full-charge at the AtRate value of charge.
- When the AtRate() value is negative, the AtRateTimeToEmpty() function returns the predicted operating time at the AtRate value of discharge.
- When the AtRate() value is negative, the AtRateOK() function returns a Boolean value that predicts the battery's ability to supply the AtRate value of *additional* discharge energy (current or power) for 10 seconds.

The default value for AtRate() is zero. Writing AtRate() values over the HDQ16 serial port does *not* trigger a re-calculation of AtRateTimeToFull(), AtRateTimeToEmpty(), and AtRateOK() functions.

It is recommended that AtRate() requests should be limited to one request every 4 seconds.

SMBus Protocol: Read or Write Word

Input/Output: Signed integer-charge or discharge; the AtRate() value is positive for charge, negative for discharge, and zero for neither (default).

	BATTERY MODES	
	CAPACITY_MODE BIT = 0	CAPACITY_MODE BIT = 1
Units	mA	10 mW
Charge Range	1 to 132,767 mA	1 to 32,767 10 mW
Discharge Range	-1 to -32,768 mA	-1 to -32,768 10 mW
Granularity	1 Unit	
Accuracy	NA	

AtRateTimeToFull() (0x05); [0x05]

Description: Returns the predicted remaining time to fully charge the battery at the AtRate() value (mA).

Purpose: The AtRateTimeToFull() function is part of a two-function call-set used to determine the predicted remaining charge time at the AtRate value in mA. The bq2063 updates AtRateTimeToFull() within 1.3 seconds after the SMBus Host sets the AtRate value. If read before this delay, the command is No Acknowledged and the error code in BatteryStatus is set to not ready. The bq2063 automatically updates AtRateTimeToFull() based on the AtRate() value every 20 seconds.

SMBus Protocol: Read Word

Output: Unsigned integer-predicted time in minutes to fully charge the battery.

Units: minutes

AtRateTimeToFull() (0x05); [0x05] (continued)**Range:** 0 to 65,534 min**Granularity:** 2 min or better**Accuracy:** $\pm \text{MaxError}() * \text{FullChargeCapacity}() / |\text{AtRate}()|$ **Invalid Data Indication:** 65,535 indicates the battery is not being charged.**AtRateTimeToEmpty() (0x06); [0x06]****Description:** Returns the predicted remaining operating time if the battery is discharged at the $\text{AtRate}()$ value.**Purpose:** The $\text{AtRateTimeToEmpty}()$ function is part of a two-function call-set used to determine the remaining operating time at the $\text{AtRate}()$ value. The bq2063 updates $\text{AtRateTimeToEmpty}()$ within 1.3 seconds after the SMBus Host sets the $\text{AtRate}()$ value. If read before this delay, the command is No Acknowledged, and the error code in BatteryStatus is set to *not ready*. The bq2063 automatically updates $\text{AtRateTimeToEmpty}()$ based on the $\text{AtRate}()$ value every 20 seconds.**SMBus Protocol:** Read Word**Output:** Unsigned integer – estimated operating time left.**Units:** minutes**Range:** 0 to 65,534 min**Granularity:** 2 min or better**Accuracy:** $-0, +\text{MaxError}() \times \text{FullChargeCapacity} / |\text{AtRate}()|$ **Invalid Data Indication:** 65,535 indicates the battery is not being discharged.**AtRateOK() (0x07); [0x07]****Description:** Returns a Boolean value that indicates whether or not the battery can deliver the $\text{AtRate}()$ value of *additional* energy for 10 seconds (Boolean). If the AtRate value is zero or positive, the $\text{AtRateOK}()$ function ALWAYS returns true.**Purpose:** The $\text{AtRateOK}()$ function is part of a two-function call-set used by power management systems to determine if the battery can safely supply enough energy for an additional load. The bq2063 updates $\text{AtRateOK}()$ within 1.3 seconds after the SMBus Host sets the $\text{AtRate}()$ value. If read before this delay, the command is No Acknowledged, and the error code in BatteryStatus is set to *not ready*. The bq2063 automatically updates $\text{AtRateOK}()$ based on the $\text{AtRate}()$ value every 20 seconds.**SMBus Protocol:** Read Word**Output:** Boolean—indicates if the battery can supply the *additional* energy requested.**Units:** Boolean**Range:** TRUE, FALSE**Granularity:** not applicable**Accuracy:** not applicable

**SBS v1.1-COMPLIANT Li-ION GAS-GAUGE IC
WITH PROTECTOR INTERFACE**SLUS468E– MAY 2001 – REVISED APRIL 2002

command codes (continued)**Temperature() (0x08); [0x08]****Description:** Returns the temperature (K) measured by the bq2063.**Purpose:** The Temperature() function provides accurate cell temperatures for use by battery chargers and thermal management systems. A battery charger can use the temperature as a safety check. Thermal management systems may use the temperature because the battery is one of the largest thermal sources in a system.**SMBus Protocol:** Read Word**Output:** Unsigned integer—cell temperature in tenth-degree Kelvin increments.**Units:** 0.1°K**Range:** 0 to +6553.5°K {real range}**Granularity:** 0.1°K**Accuracy:** ±1.5°K (from ideal Semitec 103AT thermistor performance, after calibration)
±3.0°K (Internal temperature sensor after calibration)**Voltage() (0x09); [0x09]****Description:** Returns the cell-pack voltage (mV).**Purpose:** The Voltage() function provides power management systems with an accurate battery terminal voltage. Power management systems can use this voltage, along with battery current information, to characterize devices they control. This ability helps enable intelligent, adaptive power-management systems.**SMBus Protocol:** Read Word**Output:** Unsigned integer-battery terminal voltage in mV.**Units:** mV**Range:** 0 to 20,000 mV**Granularity:** 1 mV**Accuracy:** ±0.65% (after calibration)**Current() (0x0a); [0x0a]****Description:** Returns the current being supplied (or accepted) by the battery (mA).**Purpose:** The Current() function provides a snapshot for the power management system of the current flowing into or out of the battery. This information is of particular use in power-management systems because they can characterize individual devices and tune their operation to actual system power behavior.**SMBus Protocol:** Read Word**Output:** Signed integer-charge/discharge rate in mA increments-positive for charge, negative for discharge.**Units:** mA**Range:** ($\pm 250\text{mV}/R_S$) mA**Granularity:** 0.038mV/ R_S (integer value)**Accuracy:** ±0.4 mV/ R_S (after calibration)

command codes (continued)**AverageCurrent() (0x0b); [0x0b]**

Description: Returns a value that approximates a one-minute rolling average of the current being supplied (or accepted) through the battery terminals (mA). The AverageCurrent() function returns meaningful values during **the battery's first minute of operation.**

Purpose: The AverageCurrent() function provides the average current flowing into or out of the battery for the power management system.

SMBus Protocol: Read Word

Output: Signed integer-charge/discharge rate in mA increments-positive for charge, negative for discharge.

Units: mA

Range: (± 250 mV/R_S) mA

Granularity: 0.038 mV/R_S (integer value)

Accuracy: ± 0.4 mV/R_S (after calibration)

MaxError() (0x0c); [0x0c]

Description: Returns the expected margin of error (%) in the state of charge calculation. For example, when MaxError() returns 10% and RelativeStateOfCharge() returns 50%, the Relative StateOfCharge() is more likely between 50% and 60%. The bq2063 sets MaxError() to 100% on a full reset. The bq2063 sets MaxError() to 2% on completion of a learning cycle, unless the bq2063 limits the learning cycle to the +512/-256 mAh maximum adjustment values. If the learning cycle is limited, the bq2063 sets MaxError() to 8% unless MaxError() was already below 8%. In this case MaxError() does not change. The bq2063 increments MaxError() by 1% after four increments of CycleCount() without a learning cycle.

If voltage-based corrections are applied to the coulomb counter, MaxError() is set to 25%.

Purpose: The MaxError() function has real value in two ways: first, to give the user a confidence level about the state of charge and second, to give the power management system information about how aggressive it should be, particularly as the battery nears the end of its life.

SMBus Protocol: Read Word

Output: Unsigned integer—percent uncertainty for selected information.

Units: %

Range: 2–100%

Granularity: 1%

Accuracy: not applicable

SBS v1.1-COMPLIANT Li-ION GAS-GAUGE IC WITH PROTECTOR INTERFACE

SLUS468E– MAY 2001 – REVISED APRIL 2002

command codes (continued)

RelativeStateOfCharge() (0x0d); [0x0d]

Description: Returns the predicted remaining battery capacity expressed as a percentage of FullChargeCapacity() (%).

Purpose: The RelativeStateOfCharge() function is used to estimate the amount of charge remaining in the battery relative to the last learned capacity.

SMBus Protocol: Read Word

Output: Unsigned integer-percent of remaining capacity.

Units: %

Range: 0–100%

Granularity: 1%

Accuracy: -0, +MaxError()

AbsoluteStateOfCharge()(0x0e); [0x0e]

Description: Returns the predicted remaining battery capacity expressed as a percentage of DesignCapacity() (%). Note that AbsoluteStateOfCharge() can return values greater than 100%.

Purpose: The AbsoluteStateOfCharge() function is used to estimate the amount of charge remaining in the battery relative to the nominal or DesignCapacity().

SMBus Protocol: Read Word

Output: Unsigned integer-percent of remaining capacity.

Units: %

Range: 0–100+%

Granularity: 1%

Accuracy: -0, +MaxError()

RemainingCapacity() (0x0f); [0x0f]

Description: Returns the predicted charge or energy remaining in the battery. The RemainingCapacity() value is expressed in either charge (mAh at a C/5 discharge rate) or energy (10 mWh at a P/5 discharge rate), depending on the setting of the BatteryMode() CAPACITY_MODE bit.

Purpose: The RemainingCapacity() function returns the battery's remaining capacity. This information is a numeric indication of remaining charge or energy given by the Absolute or Relative StateOfCharge() functions and may be in a better form for use by power management systems.

SMBus Protocol: Read Word

Output: Unsigned integer—remaining charge in mAh or 10 mWh.

	BATTERY MODES	
	CAPACITY_MODE BIT = 0	CAPACITY_MODE BIT = 1
Units	mAh	10 mWh
Range	0–65,535mAh	0–65,535 10 mWh
Granularity	mAh	10 mWh
Accuracy	–0, +MaxError() * FullChargeCapacity()	

command codes (continued)**FullChargeCapacity() (0x10); [0x10]**

Description: Returns the predicted pack capacity when it is fully charged. The FullChargeCapacity() value is expressed in either current (mAh at a C/5 discharge rate) or power (10 mWh at a P/5 discharge rate) depending on the setting of the BatteryMode() CAPACITY_MODE bit.

Purpose: The FullChargeCapacity() function provides a means of understanding the tank size of the battery. This information, along with information about the original capacity of the battery, indicates battery wear.

SMBus Protocol: Read Word

Output: Unsigned integer—estimated full-charge capacity in mAh or 10 mWh.

	BATTERY MODES	
	CAPACITY_MODE BIT = 0	CAPACITY_MODE BIT = 1
Units	mAh	10 mWh
Range	0–65,535 mAh	0–65,535 10 mWh
Granularity	mAh	10 mWh
Accuracy	–0, +MaxError() * FullChargeCapacity()	

RunTimeToEmpty() (0x11); [0x11]

Description: Returns the predicted remaining battery life at the present rate of discharge (minutes). The RunTimeToEmpty() value is calculated based on either current or power depending on the setting of the BatteryMode() CAPACITY_MODE bit.

Purpose: The RunTimeToEmpty() provides the power management system with information about the relative gain or loss in remaining battery life in response to a change in power policy. This information is **not** the same as the AverageTimeToEmpty(), which is not suitable to determine the effects that result from a change in power policy.

SMBus Protocol: Read Word

Output: Unsigned integer—minutes of operation left.

Units: minutes

Range: 0 to 65,534 min

Granularity: 2 min or better

Accuracy: –0, +MaxError() * FullChargeCapacity() / Current()

Invalid Data Indication: 65,535 indicates battery is not being discharged.

AverageTimeToEmpty() (0x12); [0x12]

Description: Returns a one-minute rolling average of the predicted remaining battery life (minutes). The AverageTimeToEmpty() value is calculated based on either current or power depending on the setting of the BatteryMode() CAPACITY_MODE bit.

Purpose: The AverageTimeToEmpty() displays state-of-charge information in a more useful way. It averages the instantaneous estimations so the remaining time does not appear to jump around.

SMBus Protocol: Read Word

Output: Unsigned integer—minutes of operation left.

Units: minutes

Range: 0 to 65,534 min

Granularity: 2 min or better

Accuracy: –0, +MaxError() * FullChargeCapacity() / AverageCurrent()

Invalid Data Indication: 65,535 indicates battery is not being discharged.

**SBS v1.1-COMPLIANT Li-ION GAS-GAUGE IC
WITH PROTECTOR INTERFACE**SLUS468E– MAY 2001 – REVISED APRIL 2002

command codes (continued)**AverageTimeToFull() (0x13); [0x13]**

Description: Returns a one-minute rolling average of the predicted remaining time until the battery reaches full charge (minutes).

Purpose: The AverageTimeToFull() function can be used by the SMBus Host's power management system to aid in its policy. It may also be used to find out how long the system must be left on to achieve full charge.

SMBus Protocol: Read Word

Output: Unsigned integer -remaining time in minutes.

Units: minutes

Range: 0 to 65,534 minutes

Granularity: 2 minutes or better

Accuracy: $-0, +\text{MaxError}() * \text{FullChargeCapacity}() / \text{AverageCurrent}()$

Invalid Data Indication: 65,535 indicates the battery is not being charged.

ChargingCurrent() (0x14); [0x14]

Description: Returns the desired charging rate in mA.

Purpose: The ChargingCurrent() function sets the maximum charge current of the battery. The ChargingCurrent() value should be used in combination with the ChargingVoltage() value to set the charger's operating point. Together, these functions permit the bq2063 to dynamically control the charging profile (current/voltage) of the battery. The bq2063 can effectively turn off a charger by returning a value of 0 for this function. The charger may be operated as a constant-voltage source above its maximum regulated current range by returning a ChargingCurrent() value of 65,535.

SMBus Protocol: Read Word

Output: Unsigned integer-maximum charger output current in mA.

Units: mA

Range: 0 to 65,535 mA

Granularity: 1 mA

Accuracy: not applicable

Invalid Data Indication: 65,535 indicates that a charger should operate as a voltage source outside its maximum regulated current range.

ChargingVoltage() (0x15); [0x15]

Description: Returns the desired charging voltage in mV.

Purpose: The ChargingVoltage() function sets the maximum charge voltage of the battery. The ChargingVoltage() value should be used in combination with the ChargingCurrent() value to set the charger's operating point. Together, these functions permit the bq2063 to dynamically control the charging profile (current/voltage) of the battery. The charger may be operated as a constant-current source above its maximum regulated voltage range by returning a ChargingVoltage() value of 65,535.

SMBus Protocol: Write Word

Output: Unsigned integer-charger output voltage in mV.

Units: mV

Range: 0 to 65,535 mV

Granularity: 1mV

Accuracy: not applicable

Invalid Data Indication: 65,535 indicates the charger should operate as a current source outside its maximum regulated voltage range.

command codes (continued)**BatteryStatus()(0x16); [0x16]**

Description: Returns the bq2063's status word (flags). Some of the BatteryStatus() flags (REMAINING_CAPACITY_ALARM and REMAINING_TIME_ALARM) are calculated based on either current or power depending on the setting of the BatteryMode() CAPACITY_MODE bit. This is important because use of the wrong calculation mode may result in an inaccurate alarm.

Purpose: The BatteryStatus() function is used by the power-management system to get alarm and status bits, as well as error codes from the bq2063. This is basically the same information broadcast to both the SMBus Host and the Smart Battery Charger by the AlarmWarning() function except that the AlarmWarning() function sets the Error Code bits all high before sending the data.

SMBus Protocol: Read Word

Output: Unsigned Integer-Status Register With Alarm Conditions Bit Mapped as follows:

ALARM BITS	
0x8000	OVER_CHARGED_ALARM
0x4000	TERMINATE_CHARGE_ALARM
0x2000	Reserved
0x1000	OVER_TEMP_ALARM
0x0800	TERMINATE_DISCHARGE_ALARM
0x0400	Reserved
0x0200	REMAINING_CAPACITY_ALARM
0x0100	REMAINING_TIME_ALARM
STATUS BITS	
0x0080	INITIALIZED
0x0040	DISCHARGING
0x0020	FULLY_CHARGED
0x0010	FULLY_DISCHARGED
ERROR CODES	
0x0007	Unknown Error
0x0006	BadSize
0x0005	Overflow/Underflow
0x0004	AccessDenied
0x0003	UnsupportedCommand
0x0002	ReservedCommand
0x0001	Busy
0x0000	OK

alarm bits

OVER_CHARGED_ALARM bit is set whenever the bq2063 detects that the battery is being charged beyond the *Maximum Overcharge* limit. This bit is cleared when the bq2063 detects that the battery is no longer being charged (i.e., the bq2063 detects discharge activity or no activity for the digital filter timeout periods). The digital filter timeout period (seconds) equates to 10× the value shared in *Digital Filter* EE0x52.

TERMINATE_CHARGE_ALARM bit is set when the bq2063 detects that one or more of the battery's charging parameters are out of range (e.g., its voltage, current, or temperature is too high) or when the bq2063 detects a primary charge termination. This bit is cleared when the parameter falls back into the allowable range, the termination condition ceases, or when the bq2063 detects that the battery is no longer being charged.

SBS v1.1-COMPLIANT Li-ION GAS-GAUGE IC WITH PROTECTOR INTERFACE

SLUS468E– MAY 2001 – REVISED APRIL 2002

alarm bits (continued)

OVER_TEMP_ALARM bit is set when the bq2063 detects that the internal battery temperature is greater than or equal to the *MaxT* limit. This bit is cleared when the internal temperature falls back into the acceptable range.

TERMINATE_DISCHARGE_ALARM bit is set when $RM = 0$, $Voltage() \leq EDV0$, or the CVUV bit in Pack Status is set indicating that a Li-Ion cell voltage has dropped below the limit programmed in *Cell Under /Over Voltage*. The bit is cleared when $Voltage() > EDV0$, $RM() > 0$, and the CVUV bit is cleared.

REMAINING_CAPACITY_ALARM bit is set when the bq2063 detects that RemainingCapacity() is less than that set by the RemainingCapacityAlarm() function. This bit is cleared when either the value set by the RemainingCapacityAlarm() function is lower than the RemainingCapacity() or when the RemainingCapacity() is increased by charging.

REMAINING_TIME_ALARM bit is set when the bq2063 detects that the estimated remaining time at the present discharge rate is less than that set by the RemainingTimeAlarm() function. This bit is cleared when either the value set by the RemainingTimeAlarm() function is lower than the AverageTimeToEmpty() or when the AverageTimeToEmpty() is increased by charging.

status bits

INITIALIZED bit is set when the bq2063 has detected a valid load of EEPROM. It is cleared when the bq2063 detects an improper EEPROM load.

DISCHARGING bit is set when the bq2063 determines that the battery is not being charged. This is determined by the detection of discharge activity or by the absence of charge activity for $22500/DigitalFilter(\mu V)$ seconds. This bit is cleared when the bq2063 detects that the battery is being charged.

FULLY_CHARGED bit is set when the bq2063 detects a primary charge termination or an overcharged condition. It is cleared when RelativeStateOfCharge() is less than or equal to the programmed *Fully Charged Clear %* in EE 0x4c.

FULLY_DISCHARGED bit is set when Voltage() or VCELL is less than the EDV2 threshold and $Current() < OverloadCurrent$ or when $RelativeStateOfCharge() < Battery\ Low\ \%$. This bit is cleared when $RelativeStateOfCharge()$ is greater than or equal to 20%.

error codes

ERROR CODES	DESCRIPTION
OK	The bq2063 processed the function code without detecting any errors.
Busy	The bq2063 is unable to process the function code at this time.
Reserved	The bq2063 detected an attempt to read or write to a function code reserved by this version of the specification. The 2063 detected an attempt to access an unsupported optional manufacturer function code.
Unsupported	The bq2063 does not support this function code which is defined in this version of the specification.
AccessDenied	The bq2063 detected an attempt to write to a read-only function code.
Over/Underflow	The bq2063 detected a data overflow or underflow.
BadSize	The bq2063 detected an attempt to write to a function code with an incorrect data block.
UnknownError	The bq2063 detected an unidentifiable error.

command codes (continued)**CycleCount() (0x17); [0x17]**

Description: Returns the number of cycles the battery has experienced. The mAh value of each count is determined by programming the *Cycle Count Threshold* value in EE 0x3c-0x3d. The bq2063 saves the cycle count value to *Cycle Count* EE 0x0e-0x0f after an update to CycleCount().

Purpose: The CycleCount() function provides a means to determine the battery's wear. It may be used to give advance warning that the battery is nearing its end of life.

SMBus Protocol: Read Word

Output: Unsigned integer-count of total charge removed from the battery over its life.

Units: cycle

Range: 0 to 65,534 cycles; 65,535 indicates battery has experienced 65,535 or more cycles.

Granularity: 1 cycle

Accuracy: absolute count

DesignCapacity() (0x18); [0x18]

Description: Returns the theoretical or nominal capacity of a new pack. The DesignCapacity() value is expressed in either current (mAh at a C/5 discharge rate) or power, (10 mWh at a P/5 discharge rate) depending on the setting of the BatteryMode() CAPACITY_MODE bit.

Purpose: The DesignCapacity() function is used by the SMBus Host's power management in conjunction with FullChargeCapacity() to determine battery wear. The power management system may present this information to the user and also adjust its power policy as a result.

SMBus Protocol: Read Word

Output: Unsigned integer-battery capacity in mAh or 10 mWh.

	BATTERY MODES	
	CAPACITY_MODE BIT = 0	CAPACITY_MODE BIT = 1
Units	mAh	10 mWh
Range	0–65,535 mAh	0–65,535 10 mWh
Granularity	Not applicable	
Accuracy	Not applicable	

DesignVoltage() (0x19); [0x19]

Description: Returns the theoretical voltage of a new pack (mV). The bq2063 sets DesignVoltage() to the value programmed in *Design Voltage* EE0x12-0x13.

Purpose: The DesignVoltage() function can be used to give additional information about a particular Smart Battery's expected terminal voltage.

SMBus Protocol: Read Word

Output: Unsigned integer-the battery's designed terminal voltage in mV

Units: mV

Range: 0 to 65,535 mV

Granularity: not applicable

Accuracy: not applicable

SBS v1.1-COMPLIANT Li-ION GAS-GAUGE IC WITH PROTECTOR INTERFACE

SLUS468E– MAY 2001 – REVISED APRIL 2002

command codes (continued)

SpecificationInfo() (0x1a); [0x1a]

Description: Returns the version number of the Smart Battery specification the battery pack supports, as well as voltage and current scaling information in a packed unsigned integer. Power scaling is the product of the voltage scaling times the current scaling. The SpecificationInfo is packed in the following fashion: (SpecID_H * 0x10 + SpecID_L) + (VScale + IPScale * 0x10) * 0x100.

The bq2063 VScale (voltage scaling) and IPScale (current scaling) should always be set to zero. The bq2063 sets SpecificationInfo() to the value programmed in *Specification Information* EE 0x14-0x15.

Purpose: The SpecificationInfo() function is used by the SMBus Host's power management system to determine what information the Smart Battery can provide.

SMBus Protocol: Read Word

Output: Unsigned integer-packed specification number and scaling information:

FIELD	BITS USED	FORMAT	ALLOWABLE VALUES
SpecID_L	0...3	4-bit binary value	0–15
SpecID_H	4...7	4-bit binary value	0–15
VScale	8...11	4-bit binary value	0 (multiplies voltage by 10 ^{VScale})
IPScale	12...15	4-bit binary value	0 (multiplies current by 10 ^{IPScale})

ManufactureDate() (0x1b); [0x1b]

Description: This function returns the date the cell pack was manufactured in a packed integer. The date is packed in the following fashion: (year-1980) * 512 + month * 32 + day. The bq2063 sets ManufactureDate() to the value programmed in *Manufacture Date* EE 0x16-0x17.

Purpose: The ManufactureDate() provides the system with information that can be used to uniquely identify a particular battery pack when used in conjunction with SerialNumber().

SMBus Protocol: Read Word

Output: Unsigned integer-packed date of manufacture:

FIELD	BITS USED	FORMAT	ALLOWABLE VALUES
Day	0...4	5-bit binary value	0–31 (corresponds to date)
Month	5...8	4-bit binary value	1–12 (corresponds to month number)
Year	9...15	7-bit binary value	0–127 (corresponds to year biased by 1980)

SerialNumber() (0x1c); [0x1c]

Description: This function is used to return a serial number. This number, when combined with the ManufacturerName(), the DeviceName(), and the ManufactureDate(), uniquely identifies the battery (unsigned integer). The bq2063 sets SerialNumber() to the value programmed in *Serial Number* EE 0x18–0x19.

Purpose: The SerialNumber() function can be used to identify a particular battery. This may be important in systems that are powered by multiple batteries where the system can log information about each battery that it encounters.

SMBus Protocol: Read Word

Output: Unsigned integer

command codes (continued)**ManufacturerName() (0x20); [0x20-0x25]**

Description: This function returns a character array containing the battery's manufacturer's name. For example, MyBattCo identifies the Smart Battery's manufacturer as MyBattCo. The bq2063 sets ManufacturerName() to the value programmed in *Manufacturer Name* EE 0x20-0x2b.

Purpose: The ManufacturerName() function returns the name of the Smart Battery's manufacturer. The manufacturer's name can be displayed by the SMBus Host's power management system display as both an identifier and as an advertisement for the manufacturer. The name is also useful as part of the information required to uniquely identify a battery.

SMBus Protocol: Read Block

Output: String-character string with maximum length of 11 characters (11 + length byte).

DeviceName() (0x21); [0x28-0x2b]

Description: This function returns a character string that contains the battery's name. For example, a DeviceName() of bq2063A indicates that the battery is a model bq2063A. The bq2063 sets DeviceName() to the value programmed in *Device Name* EE 0x30-0x37.

Purpose: The DeviceName() function returns the battery's name for identification purposes.

SMBus Protocol: Read Block

Output: String-character string with maximum length of 7 characters (7 + length byte).

DeviceChemistry() (0x22); [0x30-0x32]

Description: This function returns a character string that contains the battery's chemistry. For example, if the DeviceChemistry() function returns *NiMH*, the battery pack contains nickel metal hydride cells. The bq2063 sets DeviceChemistry() to the value programmed in *Device Chemistry* EE 0x40-0x44.

Purpose: The DeviceChemistry() function gives cell chemistry information for use by charging systems. The bq2063 does not use DeviceChemistry() values for internal charge control or fuel gauging.

SMBus Protocol: Read Block

Output: String-character string with maximum length of 4 characters (4 + length byte).

The following is a partial list of chemistries and their expected abbreviations. These abbreviations are *not* case sensitive.

Lead acid	PbAc
Lithium ion	LION
Nickel cadmium	NiCd
Nickel metal hydride	NiMH
Nickel zinc	NiZn
Rechargeable alkaline-manganese	RAM
Zinc air	ZnAr

SBS v1.1-COMPLIANT Li-ION GAS-GAUGE IC WITH PROTECTOR INTERFACE

SLUS468E– MAY 2001 – REVISED APRIL 2002

command codes (continued)

The ManufacturerData() (0x23);[0x38–0x3a]

Description: This function allows access to the manufacturer data contained in the battery (data). The bq2063 stores seven critical operating parameters in this data area.

Purpose: The ManufacturerData() function may be used to access the manufacturer's data area. The data fields of this command reflect the programming of five critical EEPROM locations and can be used to facilitate evaluation bq2063 under various programming sets. The ManufacturerData() function returns the following information in order: *Control Mode*, *Digital Filter*, *Self-Discharge Rate*, *Battery Low %*, *Near Full*, and the pending EDV threshold voltage (low byte and high byte.)

SMBus Protocol: Read Block

Output: Block data-data that reflects EEPROM programming as assigned by the manufacturer with maximum length of 7 characters (7 + length byte).

Pack Status and Pack Configuration (0x2f); [0x2f]

This function returns the Pack Status and Pack Configuration registers. The Pack Status register contains a number of status bits relating to bq2063 operation. The Pack Status register is the least significant byte of the word.

The Pack Configuration register reflects how the bq2063 is configured as defined by the value programmed in *Pack Configuration* in EE 0x3f. The OTVC bit is cleared when the single midrange voltage correction attempt is made.

The Pack Status register consists of the following bits:

b7	b6	b5	b4	b3	b2	b1	b0
OCE	EDV2	EINT	VDQ	—	SOV	CVOV	CVUV

OCE

The OCE bit indicates that offset cancellation is enabled. The bq2063 sets this bit after VFC offset calibration is complete.

- 0 Offset calibration not enabled
- 1 Offset calibration enabled

EDV2

The EDV2 bit indicates that pack or cell voltage (program option) is less than the EDV2 threshold.

- 0 Voltage > EDV2 threshold (discharging)
- 1 Voltage ≤ EDV2 threshold

EINT

The EINT bit indicates that the VFC has detected a charge or discharge pulse.

- 0 No charge/discharge activity detected
- 1 Charge/discharge activity detected

VDQ

The VDQ bit indicates if the present discharge cycle is valid for an FCC update.

- 0 Discharge cycle not valid
- 1 Discharge cycle valid

SOV

The SOV bit indicates that the safety output limits have been exceeded. Once set, the FLAG stays set until the bq2063 is reset.

- 0 Safety limits not exceeded
- 1 Safety limits exceeded

CVOV

The CVOV bit indicates that a secondary Li-Ion protection limit has been exceeded. It is set on a prolonged overcurrent, overvoltage, or overtemperature condition. The bit is not latched and merely reflects the present overvoltage status.

- 0 No secondary protection limits exceeded
- 1 A secondary protection limit exceeded

CVUV

The CVUV bit indicates that a secondary Li-Ion protection limit has been exceeded. It is set on an overload or over-discharge condition. The bit is not latched and merely reflects the present undervoltage status.

- 0 No secondary protection limits exceeded
- 1 A secondary protection limit exceeded

VCELL4-VCELL1 (0x3c-0x3f); [0x3c-0x3f]

These functions return the calculated individual cell voltages in mV.

EEPROM**general**

The bq2063 accesses the external EEPROM during reset and when storing historical data. During an EEPROM access, the VOUT pin becomes active and the bq2063 uses the ESCL and ESDA pins to communicate with the EEPROM. The EEPROM stores basic configuration information for use by the bq2063. The EEPROM must be programmed correctly for proper bq2063 operation.

memory map

Table 12 shows the memory map for the EEPROM. It contains example data for a 3s3p Li-Ion battery pack with a 0.05-Ω sense resistor.

Table 10. EEPROM Memory Map

EEPROM ADDRESS		NAME	LI-ION EXAMPLE	DATA	
				MSB	LSB
0x00	0x01	Check Byte 1	15487	3c	7f
0x02	0x03	Remaining Time Alarm	10 minutes	00	0a
0x04	0x05	Remaining Capacity Alarm	400 mAh	01	90
0x06		EDV C1 Factor	0		00
0x07		EDV TC Factor	0		00
0x08		Safety Overtemperature	75°C		c3
0x09		Reserved	0		00
0x0a	0x0b	Charging Voltage	12600 mV	31	38

NOTE: Reserved locations must be set as shown. Locations marked with an * are calibration values that can be adjusted for maximum accuracy. For these locations the table shows the appropriate default or initial setting.

SBS v1.1-COMPLIANT Li-ION GAS-GAUGE IC WITH PROTECTOR INTERFACE

SLUS468E– MAY 2001 – REVISED APRIL 2002

Table 10. EEPROM Memory Map (Continued)

EEPROM ADDRESS		NAME	Li-ION EXAMPLE	DATA	
				MSB	LSB
0x0c	0x0d	Reserved	128	00	80
0x0e	0x0f	<i>Cycle Count</i>	0	00	00
0x10	0x11	Reserved	0	00	00
0x12	0x13	<i>Design Voltage</i>	10800 mV	2a	30
0x14	0x15	<i>Specification Information</i>	v1.1/PEC	00	31
0x16	0x17	<i>Manufacture Date</i>	2/25/99=9817	26	59
0x18	0x19	<i>Serial Number</i>	1	00	01
0x1a	0x1b	<i>Fast-Charging Current</i>	3000 mA	0b	b8
0x1c		<i>Pack Load Estimate</i>	0 mA		00
0x1d		<i>Maintenance Charging Current</i>	0 mA	00	00
0x1e		<i>Pre-Charge Current</i>	96 mA	00	0C
0x1f		<i>Safety Overvoltage</i>	13056 mV		8C
0x20		<i>Manufacturer Name Length</i>	9		09
0x21		Character 1	B		42
0x22		Character 2	E		45
0x23		Character 3	N		4e
0x24		Character 4	C		43
0x25		Character 5	H		48
0x26		Character 6	M		4d
0x27		Character 7	A		41
0x28		Character 8	R		52
0x29		Character 9	Q		51
0x2a		Character 10	—		00
0x2b		Character 11	—		00
0x2c	0x2d	Reserved	0	00	00
0x2e	0x2f	<i>Maximum Overcharge</i>	350 mAh	fe	a2
0x30		<i>Device Name Length</i>	6		06
0x31		Character 1	B		42
0x32		Character 2	Q		51
0x33		Character 3	2		32
0x34		Character 4	0		30
0x35		Character 5	6		36
0x36		Character 6	3		33
0x37		Character 7	—		00
0x38	0x39	<i>Last Measured Discharge</i>	4500 mAh	11	94
0x3a	0x3b	<i>Pack Capacity</i>	4500 mAh	11	94
0x3c	0x3d	<i>Cycle Count Threshold</i>	3600 mAh	0e	10
0x3e		Reserved	0		00
0x3f		<i>Pack Configuration</i>	DMODE, SEAL, CSYNC, OTVC		e2
0x40		<i>Device Chemistry Length</i>	4		04
0x41		Character 1	L		4c

NOTE: Reserved locations must be set as shown. Locations marked with an * are calibration values that can be adjusted for maximum accuracy. For these locations the table shows the appropriate default or initial setting.

SBS v1.1-COMPLIANT Li-ION GAS-GAUGE IC WITH PROTECTOR INTERFACE

SLUS468E–MAY 2001 – REVISED APRIL 2002

Table 10. EEPROM Memory Map (Continued)

EEPROM ADDRESS		NAME	Li-ION EXAMPLE	DATA	
				MSB	LSB
0x42		Character 2	I		49
0x43		Character 3	O		4f
0x44		Character 4	N		4e
0x45		MaxT LowT	50°C, 4.8°C		c6
0x46	0x47	Overload Current	6000 mA	17	70
0x48		Overvoltage Margin	800 mV		32
0x49		Overcurrent Margin	512 mA		20
0x4a		Cell Under/Over Voltage	2496 mV/4384 mV		79
0x4b		Fast Charge Termination %	100%		ff
0x4c		Fully Charged Clear %	95%		a1
0x4d		Charge Efficiency	100%		ff
0x4e		Current Taper Threshold	200 mA		08
0x4f		Current Taper Qual Voltage	128 mV		40
0x50		Manufacturer Data Length	7		07
0x51		Control Mode	SC		04
0x52		Digital Filter	50 μ V		2d
0x53		Self-Discharge Rate	0.21%		05
0x54		Battery Low %	7%		12
0x55		Near Full	200 mAh		64
0x56	0x57	Reserved	0	00	00
0x58	0x59	Reserved	0	00	00
0x5a	0x5b	Reserved	0	00	00
0x5c	0x5d	Reserved	0	00	00
0x5e	0x5f	VFC Offset*	0	00	00
0x60		VFC Offset*	0	-	00
0x61		Temperature Offset*	0	-	00
0x62		ADC Offset*	0	-	00
0x63		Pack Programming	PDLY	-	01
0x64		Light Load Estimate	0	-	00
0x65		Reserved	0	-	00
0x66	0x67	ADC Voltage Gain*	5 : 1	30	d4
0x68	0x69	ADC Sense Resistor Gain*	0.05 Ω	30	d4
0x6a	0x6b	VFC Sense Resistor Gain*	0.05 Ω	20	00
0x6c	0x6d	VOC25	11170 mV	d4	5e
0x6e	0x6f	VOC50	11370 mV	d3	96
0x70	0x71	VOC75	11730 mV	d2	2e
0x72	0x73	EDVF/EDV0	3000 mV	0b	b8
0x74	0x75	EMF/ EDV1	3433 mV	0d	69
0x76	0x77	EDV T0 Factor	0	00	00
0x78	0x79	EDV C0 Factor/EDV2	3567 mV	0d	ef
0x7a	0x7b	EDV R0 Factor	0	00	e0
0x7c	0x7d	EDV R1 Factor	0	00	00
0x7e	0x7f	Check Byte 2	42330	a5	5a

NOTE: Reserved locations must be set as shown. Locations marked with an * are calibration values that can be adjusted for maximum accuracy. For these locations the table shows the appropriate default or initial setting.

SBS v1.1-COMPLIANT Li-ION GAS-GAUGE IC WITH PROTECTOR INTERFACE

SLUS468E– MAY 2001 – REVISED APRIL 2002

PROGRAMMING INFORMATION

EEPROM programming

The following sections describes the function of each EEPROM location and how the data is to be stored.

fundamental parameters

sense resistor value

Two factors are used to scale the current related measurements. The 16-bit *ADC Sense Resistor Gain* value in EE 0x68-0x69 scales Current() to mA. Adjusting *ADC Sense Resistor Gain* from its nominal value provides a method to calibrate the current readings for system errors and the sense resistor value (Rs) . The nominal value is set by

$$ADC\ Sense\ Resistor\ Gain = \frac{625}{(Rs)} \quad (4)$$

The 16-bit *VFC Sense Resistor Gain* in EE 0x6a-0x6b scales each VFC interrupt to mAh. *VFC Sense Resistor Gain* is based on the resistance of the series sense resistor. The following formula computes a nominal or starting value for *VFC Sense Resistor Gain* from the sense resistor value.

$$VFC\ Capital\ Sense\ Resistor\ Gain = \frac{409.6}{(Rs)} \quad (5)$$

Sense resistor values are limited to the range of 0.00916 to 0.100Ω.

digital filter

The desired digital filter threshold, VDF (μV), is set by the value stored in *Digital Filter* EE 0x52.

$$Digital\ Filter = \frac{2250}{VDF} \quad (6)$$

cell characteristics

battery pack capacity and voltage

Pack capacity in mAh units is stored in *Pack Capacity*, EE 0x3a-0x3b. In mAh mode, the bq2063 copies *Pack Capacity* to *DesignCapacity*(). In mWh mode, the bq2063 multiplies *Pack Capacity* by *Design Voltage* EE 0x12-0x13 to calculate *DesignCapacity*() scaled to 10 mWh. *Design Voltage* is stored in mV.

The initial value for *Last Measured Discharge*, in mAh, is stored in EE 0x38–0x39. *Last Measured Discharge* is modified over the course of pack usage to reflect cell aging under the particular use conditions. The bq2063 updates *Last Measured Discharge* in mAh after a capacity learning cycle. The bq2063 uses the *Last Measured Discharge* value to calculate *FullChargeCapacity*() in mAh or 10 mWh mode.

EDV thresholds and near full percentage

The bq2063 uses three pack voltage thresholds to provide voltage-based warnings of low battery capacity. The bq2063 uses the values stored in EEPROM for the EDV0, EDV1, and EDV2 values or calculates the three thresholds from a base value and the temperature, capacity, and rate adjustment factors stored in EEPROM. If EDV compensation is disabled then EDV0, EDV1, and EDV2 are stored directly in mV in EE 0x72-0x73, EE 0x74-0x75, and EE 0x78-0x79, respectively.

For capacity correction at EDV2, *Battery Low %* EE 0x54 can be set at a desired state-of-charge, STATEOFCHARGE%, in the range of 3-19%. Typical values for STATEOFCHARGE% are 5-7% representing 5-7% capacity.

$$Battery\ Low\ \% = STATEOFCHARGE\% \cdot 2.56 \quad (7)$$

PROGRAMMING INFORMATION

EDV thresholds and near full percentage (continued)

The bq2063 updates FCC if a qualified discharge occurs from a near-full threshold of FCC – NFW, until EDV2 condition is reached. The desired near-full threshold window, NFW (mAh), is programmed in *Near Full* in EE 0x55.

$$\text{Near Full} = \frac{\text{NFW}}{2} \quad (8)$$

EVD discharge rate and temperature compensation

If EDV compensation is enabled, the bq2063 calculates battery voltage to determine EDV0, EDV1, and EDV2 thresholds as a function of battery capacity, temperature, and discharge load. The general equation for EDV0, EDV1, and EDV2 calculation is

$$\text{EDV}_{0,1,2} = \text{EMF} \bullet \text{FBL} - |\text{ILOAD}| \bullet \text{R0} \bullet \text{FTZ} \quad (9)$$

Where:

EMF is a no-load battery voltage higher than the highest EDV threshold computed. EMF is programmed in mV in *EMF/EDV1* EE 0x74-0x75.

ILOAD is the current discharge load magnitude.

FBL is the factor that adjusts the EDV voltage for battery capacity and temperature to match the no-load characteristics of the battery.

$$\text{FBL} = f(\text{C0}, \text{C} + \text{C1}, \text{T}) \quad (10)$$

Where:

C (either 0%, 3%, or *Battery Low %* for EDV0, EDV1, and EDV2, respectively) and C0 are the capacity-related EDV adjustment factors. C0 is programmed in *EDV C0 Factor/EDV2* EE 0x78–79. C1 is the desired residual battery capacity remaining at EDV0 (RM = 0). The C1 factor is stored in *EDV C1 Factor* EE 0x06.

T is the current temperature in °K.

R0 • FTZ represents the resistance of the battery as a function of temperature and capacity.

$$\text{FTZ} = f(\text{R1}, \text{T0}, \text{T}, \text{C} + \text{C1}, \text{TC}) \quad (11)$$

R0 is the first order rate dependency factor stored in *EDV R0 Factor* EE 0x7a-0x7b.

T is the current temperature; C is the battery capacity relating to EDV0, EDV1, and EDV2.

R1 adjusts the variation of impedance with battery capacity. R1 is programmed in *EDV R1 Rate Factor* EE 0x7c-0x7d.

T0 adjusts the variation of impedance with battery temperature). T0 is programmed in *EDV T0 Rate Factor* EE 0x76-0x77.

TC adjusts the variation of impedance for cold temperatures (T < 23°C). TC is programmed in *EDV TC* EE 0x07.

SBS v1.1-COMPLIANT Li-ION GAS-GAUGE IC WITH PROTECTOR INTERFACE

SLUS468E– MAY 2001 – REVISED APRIL 2002

PROGRAMMING INFORMATION

EVD discharge rate and temperature compensation (continued)

Typical values for the EDV compensation factors, based on overall pack voltages for a Li-Ion 3s3p 18650 pack, are

- EMF = 11550
- T0 = 4475
- C0 = 235
- C1 = 0
- R0 = 5350
- R1 = 250
- TC = 3

The graphs in Figures 11 and 12 show the calculated EDV0, EDV1, and EDV2 thresholds versus capacity using the typical compensation values for different temperatures and loads for a Li-Ion 3s3p 18650 pack. The compensation values vary widely for different cell types and manufacturers and must be matched exactly to the unique characteristics for optimal performance.

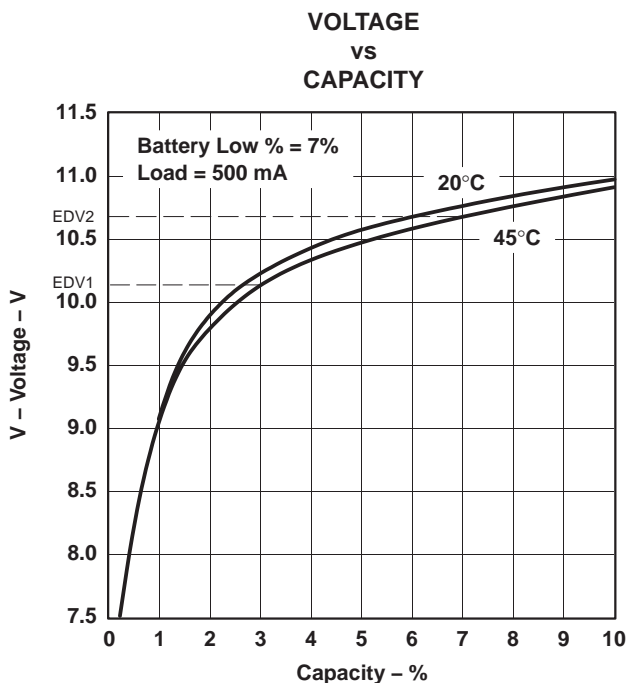

Figure 11. EDV Calculations vs Capacity for Various Temperatures

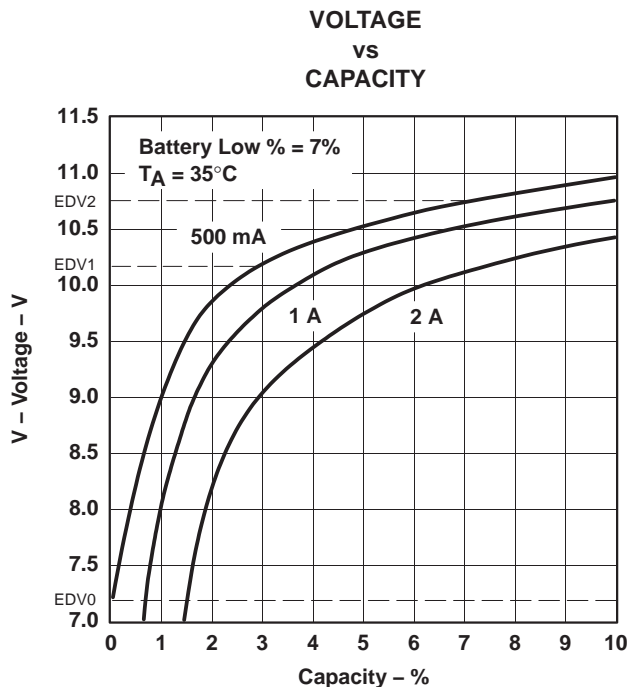

Figure 12. EDV Calculations vs Capacity for Various Loads

overload current threshold

The *Overload Current* threshold is a 16-bit value stored in EE 0x46-0x47 in mA units.

midrange capacity corrections

Three voltage-based thresholds, *VOC25* EE 0x6c-0x6d, *VOC50* EE 0x6e-0x6f, and *VOC75* EE 0x70-0x71, are used to test the accuracy of the RM based on open-circuit pack voltages. These thresholds are stored in the EEPROM in 2s complement of voltage in mV. The values represent the open-circuit battery voltage at which the battery capacity should correspond to the associated state of charge for each threshold.



PROGRAMMING INFORMATION

self-discharge rate

The nominal self-discharge rate, %PERDAY (% per day), is programmed in an 8-bit value *Self-Discharge Rate* EE 0x53 by the following relation:

$$\text{Self-Discharge Rate} = 256 - \frac{52.73}{\%PERDAY} \quad (12)$$

light load estimate

The amount of light load current in mA, ILEAK, used for compensation is stored in *Light Load Estimate* in EE 0x64 as follows:

$$\text{Light Discharge Current} = \frac{ILEAK \cdot 1024}{45} \quad (13)$$

ILEAK is between 0.044 and 11.2 mA.

charge efficiency

The bq2063 applies the efficiency factor, EFF%, to all charge added to the battery. EFF% is encoded in *Charge Efficiency* EE 0x4d according to equation 16:

$$\text{Charge Efficiency} = (\text{EFF}\% \cdot 2.56 - 1) \quad (14)$$

battery electronics load

The amount of internal battery electronics load estimate in μA , BEL, is stored in *Pack Load Estimate* EE 0x1c as follows:

$$\text{Pack Load Estimate} = 0.364 \cdot \text{BEL}$$

charging voltage

The 16-bit value, *Charging Voltage* EE 0x0a-0x0b programs the *ChargingVoltage*() value broadcast to a Smart Charger. It is also sets the base value for determining overvoltage conditions during charging and voltage compliance during a constant-voltage charging methodology. It is stored in mV.

overvoltage

The 8-bit value, *Overvoltage Margin* EE 0x48, sets the limit over *ChargingVoltage*() that is to be considered as an overvoltage charge-suspension condition. The voltage in mV above the *ChargingVoltage*(), VOVM, that should trigger a charge suspend is encoded in *Overvoltage Margin* as follows:

$$\text{Overvoltage Margin} = \frac{VOVM}{16} \quad (15)$$

VOVM is between 0 and 4080 mV.

charging current

ChargingCurrent() values are either broadcast to a Level 2 Smart Battery Charger or read from the bq2063 by a Level 3 Smart Battery Charger. The bq2063 sets the value of *ChargingCurrent*(), depending on the charge requirements and charge conditions of the pack.

When fast charge is allowed, the bq2063 sets *ChargingCurrent*() to the rate programmed in *Fast Charging Current* EE 0x1a-0x1b. *Fast Charging Current* is stored in mA.

SBS v1.1-COMPLIANT Li-ION GAS-GAUGE IC WITH PROTECTOR INTERFACE

SLUS468E– MAY 2001 – REVISED APRIL 2002

PROGRAMMING INFORMATION

charging current (continued)

When fast charge terminates, the bq2063 sets ChargingCurrent() to zero and then to the *Maintenance Charging Current* EE 0x1d when the termination condition ceases. MC is the desired rate in mA.

$$\text{Maintenance Charging Current} = \frac{MC}{4} \quad (16)$$

When Voltage() is less than EDV0, the bq2063 sets ChargingCurrent() to *Precharge Current* EE 0x1e. Typically this rate is larger than the maintenance rate to charge a deeply depleted pack up to the point where it may be fast charged. PCC is the desired rate in mA.

$$\text{Precharge Current} = \frac{PCC}{8} \quad (17)$$

If temperature is between 0° and the LTF threshold, the bq2063 sets ChargingCurrent() to *PreCharge Current*. LTF is programmed in the lower nibble (LSN) OF *MaxT LowT* EE0x45 as

$$\text{LowT} = \frac{\text{LTF}(\text{°C})}{0.8} \quad (18)$$

charge suspension

During charge, the bq2063 compares the current to the ChargingCurrent() plus the value IOIM. If the pack is charged at a current above the ChargingCurrent() plus IOIM, the bq2063 sets ChargingCurrent() to zero to stop charging. IOIM is programmed in the EE 0x49 value, *Overcurrent Margin*, encoded as

$$\text{Overcurrent Margin} = \frac{\text{IOIM}}{16} \quad (19)$$

Overcurrent Margin EE 0x49 may be used to program IOIM values of 0 to 4080mA in 16mA steps.

The desired temperature threshold for charge suspension, MAXTEMP, may be programmed between 45°C and 69°C in 1.6°C steps. *MaxT LowT* EE 0x45 (MSN) is stored in a 4-bit value as shown:

$$\text{MaxT} = \frac{69 - \text{MAXTEMP}}{1.6} \quad (20)$$

The bq2063 suspends fast charge when fast charge continues past full by the amount programmed in *Maximum Overcharge* EE 0x2e-0x2f. *Maximum Overcharge* is programmed in 2s complement form of charge in mAh.

FULLY_CHARGED bit clear threshold

The bq2063 clears the FULLY_CHARGED bit in BatteryStatus() when RelativeStateOfCharge() reaches the value, *Fully Charged Clear %* EE 0x4c. *Fully Charged Clear %* is an 8-bit value and is stored as a 2s complement of percent.

fast charge termination percentage

The bq2063 sets RM to a percentage of FCC on charge termination if the CSYNC bit is set in the Pack Configuration register. The percentage of FCC, FCT%, is stored in *Fast Charge Termination %* in EE 0x4b. The value is stored as shown:

$$\text{Fast Charge Termination\%} = (\text{FCT\%} * 2.56 - 1)$$

cycle count threshold

Cycle Count Threshold 0x3c-0x3d sets the number of mAh that must be removed from the battery to increment CycleCount(). Cycle Count Threshold is a 16-bit value stored in 2s complement of charge in mAh.

PROGRAMMING INFORMATION

current taper termination characteristics

Two factors in the EEPROM set the current taper termination for Li-Ion battery packs. The two coded locations are *Current Taper Qual Voltage* EE 0x4f and *Current Taper Threshold* EE 0x4e. Current taper termination occurs during charging when the pack voltage is above the charging voltage minus CTQV (mV) and the charging current is below CTT (mA) for at least 40 seconds.

$$\text{Current Taper Qual Voltage} = \frac{\text{CTQV}}{2} \quad (21)$$

$$\text{Current Taper Threshold} = \frac{R_s * \text{CTT}}{0.5625} \quad (22)$$

where i = the desired current termination threshold in mA, and R_s = VFC sense resistor in ohms.

pack options**pack configuration**

Pack Configuration EE 0x3f contains bit-programmable features.

b7	b6	b5	b4	b3	b2	b1	b0
DMODE	SEAL	CSYNC	CEDV	VCOR	EXTH	OTVC	4CELL

DMODE

The DMODE bit determines whether the LED outputs indicate `AbsoluteStateOfCharge()` or `RelativeStateOfCharge()`

- 0 LEDs reflect `AbsoluteStateOfCharge()`
- 1 LEDs reflect `RelativeStateOfCharge()`

SEAL

The SEAL bit determines the SMBus access state of the bq2063 on reset

- 0 SMBus commands (0x00-0xff) accessible for both read and write
- 1 SMBus read access limited to commands (0x05-0x1c) and (0x20-0x23). SMBus read/write access limited to commands (0x00-0x04), (0x2f), and (0x3c-0x3f).

CSYNC

In usual operation of the bq2063, the CSYNC bit is set so that the coulomb counter is adjusted when a fast charge termination is detected. In some applications, especially those where an externally controlled charger is used, it may be desirable *not* to adjust the coulomb counter. In these cases the CSYNC bit should be cleared.

- 0 The bq2063 does not alter RM at the time of a valid charge termination
- 1 The bq2063 updates RM with a programmed percentage of FCC at a valid charger termination.

CEDV

The CEDV bit determines whether the bq2063 implements automatic EDV compensation to calculate the EDV0, EDV1, and EDV2 thresholds base on rate, temperature, and capacity. If the bit is cleared, the bq2063 uses the fixed values programmed in EEPROM for EDV0, EDV1, and EDV2. If the bit is set, the bq2063 calculates EDV0, EDV1, and EDV2.

- 0 EDV compensation disabled
- 1 EDV compensation enabled

**SBS v1.1-COMPLIANT Li-ION GAS-GAUGE IC
WITH PROTECTOR INTERFACE**

SLUS468E– MAY 2001 – REVISED APRIL 2002

PROGRAMMING INFORMATION**pack options (continued)****VCOR**

The VCOR bit enables the midrange voltage correction algorithm. When it is set, the bq2063 compares the pack voltage to RM and may adjust RM according to the values programmed in VOC25, VOC50, and VOC75.

- 0 Continuous midrange corrections disabled
- 1 Continuous midrange corrections enabled

EXTH

The EXTH bit configures the bq2063 for external or internal temperature measurement. When this bit is set, the bq2063 expects an external thermistor input on the TS pin. When the bit is not set, the bq2063 uses its internal temperature sensor.

- 0 Internal temperature sensor used
- 1 External thermistor used

OTVC

The OTVC bit programs the bq2063 to perform a midrange voltage one time after a device reset.

- 0 One-time midrange correction disabled
- 1 One-time midrange correction enabled

4CELL

The 4CELL bit programs the bq2063 for three or four series-cell operation.

- 0 Configure the bq2063 for three cells
- 1 Configure the bq2063 for four cells

pack programming

Pack Programming EE 0x63 contains bit-programmable features:

b7	b6	b5	b4	b3	b2	b1	b0
—	—	—	LLTF	LLRN	EDVV	—	PDLY

PDLY

- 0 CVUV or CVOV sets immediately on first fault measurement
- 1 CVUV or CVOV requires two successive VOC measurements (2-second intervals).

EDVV

The EDVV bit selects whether EDV the termination is to be done with regard to voltage or the lowest single-cell voltage.

- 0 EDV conditions determined on the basis of the lowest single-cell voltage
- 1 EDV conditions determined on the basis of Voltage().

LLRN

LLRN bit sets the threshold above which current must be when RM reaches the Low Battery % or when Voltage() reached the EDV2 to level to maintain a qualified discharge and allow learning (FCC update).

- 0 Sets the threshold to 3C/32
- 1 Sets the threshold to C/32

PROGRAMMING INFORMATION

pack options (continued)

LLTF

The LLTF bit sets the temperature threshold used to disable the learning cycle (FCC update).

- 0 Sets the low temperature learning fault to 12C
- 1 Sets the low temperature learning fault to the value stored in *MaxT_LowT*

remaining time and capacity alarms

Remaining Time Alarm in EE 0x02-0x03 and *Remaining Capacity Alarm* in 0x04-0x05 set the alarm thresholds used in the SMBus command codes 0x01 and 0x02, respectively. *Remaining Time Alarm* is stored in minutes and *Remaining Capacity Alarm* in mAh or 10 mWh, depending on the *Battery_Mode()* setting.

secondary protection limits for Li-Ion

The cell undervoltage (VUV) and overvoltage (VOV) limits are programmed in *Cell Undervoltage/Overvoltage* EE 0x4a according to the equations:

$$\text{Cell Overvoltage (lower nibble)} = \frac{\text{VOV} - 4096}{32} \quad (23)$$

$$\text{Cell Undervoltage (upper nibble)} = \frac{\text{VUV} - 2048}{64} \quad (24)$$

CELL UNDER/OVER VOLTAGE (UPPER NIBBLE)	VUV (mV)	CELL UNDER/OVER VOLTAGE (LOWER NIBBLE)	VOV (mV)
0	2048	0	4096
1	2112	1	4128
2	2176	2	4160
3	2240	3	4192
4	2304	4	4224
5	2368	5	4256
6	2432	6	4288
7	2496	7	4320
8	2560	8	4352
9	2624	9	4384
a	2688	a	4416
b	2752	b	4448
c	2816	c	4480
d	2880	d	4512
e	2944	e	4544
f	3008	f	4576

SAFETY Threshold

The Safety Voltage threshold (SOV) in mV is programmed in *Safety Overvoltage* EE 0x1f. It is stored as

$$\text{Safety Overvoltage} = \frac{\text{SOV} - 4096}{64} \quad (25)$$

The Safety Overtemperature (SOT) in °C is programmed in *Safety Overtemperature* EE 0x08. It is stored as

$$\text{Safety Overtemperature} = (94.5 - \text{SOT}) * 10 \quad (26)$$

SBS v1.1-COMPLIANT Li-ION GAS-GAUGE IC WITH PROTECTOR INTERFACE

SLUS468E– MAY 2001 – REVISED APRIL 2002

PROGRAMMING INFORMATION

pack options (continued)

cycle count initialization

Cycle Count EE 0x0e-0x0f stores the initial value for the CycleCount() function. It should be programmed to 0x0000.

control mode

Control Mode EE0x51 contains additional bit programmable features.

b7	b6	b5	b4	b3	b2	b1	b0
NDF	—	HPE	CPE	LED	SC	—	SM

NDF

The NDF bit disables the digital filter during discharge if the SMBC and SMBD lines are high.

- 0 Digital filter enabled all the time
- 1 Digital filter disabled if SMBC and SMBD are high

HPE

The HPE bit enables/disables PEC transmissions to the Smart Battery host for master mode alarm messages.

- 0 No PEC byte on alarm warning to host
- 1 PEC byte on alarm warning to host

CPE

The CPE bit enables/disables PEC transmissions to the Smart Battery Charger for master mode messages.

- 0 No PEC byte on broadcasts to charger
- 1 PEC byte on broadcasts to charger

LED

The LED bit configures the bq2063 for 4 or 5 LED indication

- 0 Selects the 5 LED indication mode
- 1 Selects the 4 LED indication mode

SC

The SC bit enables learning cycle optimization for a Smart Charger or independent charge

- 0 Learning cycle optimized for independent charger
- 1 Learning cycle optimized for Smart Charger

SM

The SM bit enables/disables master mode broadcasts by the bq2063

- 0 Broadcasts to host and charger enabled
- 1 Broadcasts to host and charger disabled

If the SM bit is set, modifications to bits in BatteryMode() do not re-enable broadcasts.

PROGRAMMING INFORMATION

measurement calibration

ADC

To describe how the bq2063 calculates reported battery and three individual cell voltages, the following abbreviations and designations are used:

- VCELL = voltage at the input pin of the bq2063
- VCELLN = reported single-cell voltages (N = 1–4)
- Vn = single cell voltage (n = 1–4)
- VnOffset= single-cell offset voltages (n = 1–4)
- Voltage() = reported battery voltage

The bq2063 requests inputs to the VCELL pin. The S-8243 presents either a scaled single-cell voltage or the offset associated with the voltage, per Table 11. The voltage for each cell, Vn, may be determined by subtracting the offset measurement from the corresponding cell plus offset measurement.

After subtracting the two ADC readings from each cell voltage, the reported VCELLN voltage is computed as follows:

$$VCELLN = [ADC(VnOffset + 0.2 Vn) - ADC(VnOffset)] \left[\frac{ADC \text{ Voltage Gain}}{65536} \right] \quad (27)$$

$$ADC(VCELL) = \frac{VCELL * 32768}{1250} \quad (28)$$

An *ADC Voltage Gain* factor of 12500 in EE 0x66–0x67 is the nominal value to correct for the nominal 0.2 (5:1 reduction) gain of the S-8243.

The bq2063 computes the reported voltages as follows:

$$\text{Voltage}() = VCELL1 + VCELL2 + VCELL3 + VCELL4 \quad (29)$$

The bq2063 reports VCELL4 as the most positive cell in the cell stack. Note that this is documented as V1 in the S-8243 data sheet. The other cell voltages are also in inverse order.

Table 11. bq2063 to S-8243A/B Interface (Cell Voltage Input)

OUTPUT		INPUT	
CTL3	CTL4	VCELL (A series)	VCELL (A series)
High	High	V1 Offset	V1 Offset
High	Open	V1 Offset + 0.2 × V1	V1 Offset + 0.2 × V1
High	Low	Don't care	V2 Offset
Open	High	Don't care	V2 Offset + 0.2 × V2
Open	Open	V2 Offset	V3 Offset
Open	Low	V2 Offset + 0.2 × V2	V3 Offset + 0.2 × V3
Low	High	V3 Offset	V4 Offset
Low	Open	V3 Offset 0.2 × V3	V4 Offset + 0.2 × V4
Low	Low	Don't care	Don't care

NOTE: V1 = Cell 1 voltage (positive end of cell stack)

V2 = Cell 2 voltage

V3 = Cell 3 voltage

V4 = Cell 4 voltage (negative end of cell stack)

SBS v1.1-COMPLIANT Li-ION GAS-GAUGE IC WITH PROTECTOR INTERFACE

SLUS468E–MAY 2001 – REVISED APRIL 2002

PROGRAMMING INFORMATION

measurement calibration (continued)

current

The bq2063 scales Current() to mA units by the 16-bit value *ADC Sense Resistor Gain* in EE 0x68-0x69. Adjusting *ADC Sense Resistor Gain* from its nominal value provides a method to calibrate the current readings for variances in the ADC gain, internal voltage reference, and sense resistor value. The bq2063 calculates Current() by

$$\text{Current}() = \left[\frac{(\text{ADC Reading} + \text{ADC Offset}) * \text{ADC Sense Resistor Gain}}{16384} \right] \quad (30)$$

The nominal value for *ADC Sense Resistor Gain* is given by equation (4).

ADC Offset in EE 0x62 adjusts the ADC reading for bq2063 measurement offset. *ADC Offset* is a signed 8-bit value that cancels offset present in the ADC measurement. *ADC Offset* is typically between –20 and 20.

vfc

To calibrate the coulomb counting measurement for VFC gain errors and sense resistor tolerance, the value of *VFC Sense Resistor Gain* EE 0x6a-0x6b may be adjusted from its nominal value.

The nominal value of *VFC Sense Resistor Gain* is given by equation (6).

The bq2063 VFC circuit has the ability to introduce a signal opposite in sign to the inherent device and circuit offset to cancel this error. The offset calibration routine is initiated with commands to *ManufacturerAccess*().

The bq2063 calculates the offset with the calibration routine and stores the calibration value using the least 21 bits of *VFC Offset* in EE 0x5e-0x60.

The least 20 bits store the offset calibration value (OCV). The sign of the offset calibration value is positive if the 21st bit is 0.

$$\text{OCV} = \frac{0.6 \text{ V}}{\text{VFC Offset}_{19-0}} \quad (31)$$

temperature

The bq2063 uses *Temperature Offset* in EE 0x61 to calibrate the *Temperature*() function for offset. The required offset adjustment, *TOFF* (°C), sets *Temperature Offset* according to the equation

$$\text{Temperature Offset} = \text{TOFF} * 10 \quad (32)$$

Where:

$$-12.8 \leq \text{TOFF} \leq 12.7$$

constants and string data

EEPROM constants

Check Byte 1 EE 0x00-0x01 and *Check Byte 2* EE 0x7e-0x7f must be programmed to 0x3c7f and 0xa55a, respectively.

specification information

Specification Information EE 0x14-0x15 stores the default value for the *SpecificationInfo*() function. It is stored in EEPROM in the same format as the data returned by the *SpecificationInfo*().

PROGRAMMING INFORMATION

measurement calibration (continued)

manufacture date

Manufacture Date EE 0x16-0x17 stores the default value for the `ManufactureDate()` function. It is stored in EEPROM in the same format as the data returned by the `ManufactureDate()`.

serial number

Serial Number EE 0x18-0x19 stores the default value for the `SerialNumber()` function. It is stored in EEPROM in the same format as the data returned by the `SerialNumber()`.

manufacturer name data

Manufacturer Name Length EE 0x20 stores the length of the desired string that is returned by the `ManufacturerName()` function. Locations EE 0x21-0x2b store the characters for `ManufacturerName()` in ASCII code.

device name data

Device Name Length EE 0x30 stores the length of the desired string that is returned by the `DeviceName()` function. Locations EE 0x31-0x37 store the characters for `DeviceName()` in ASCII code.

device chemistry data

Device Chemistry Length EE 0x40 stores the length of the desired string that is returned by the `DeviceChemistry()` function. Locations EE 0x41-0x44 store the characters for `DeviceChemistry()` in ASCII code.

manufacturers data length

Manufacturers Data Length EE 0x50 stores the length of the desired number of bytes that is returned by the `ManufacturersData()` function. It should be set to 7.

APPLICATION INFORMATION

Figure 13 shows a typical bq2063-based battery pack application. The circuit consists of the S-8243 protection IC LED display, temperature measurement network, EEPROM connections, serial port, and the sense resistor. The EEPROM stores basic battery pack configuration information and measurement calibration values. The EEPROM must be programmed properly for bq2063 operation. Table 10 shows the EEPROM memory map and outlines the programmable functions available in the bq2063.

MECHANICAL DATA

DBQ (R-PDSO-G**)

PLASTIC SMALL-OUTLINE

24 PINS SHOWN

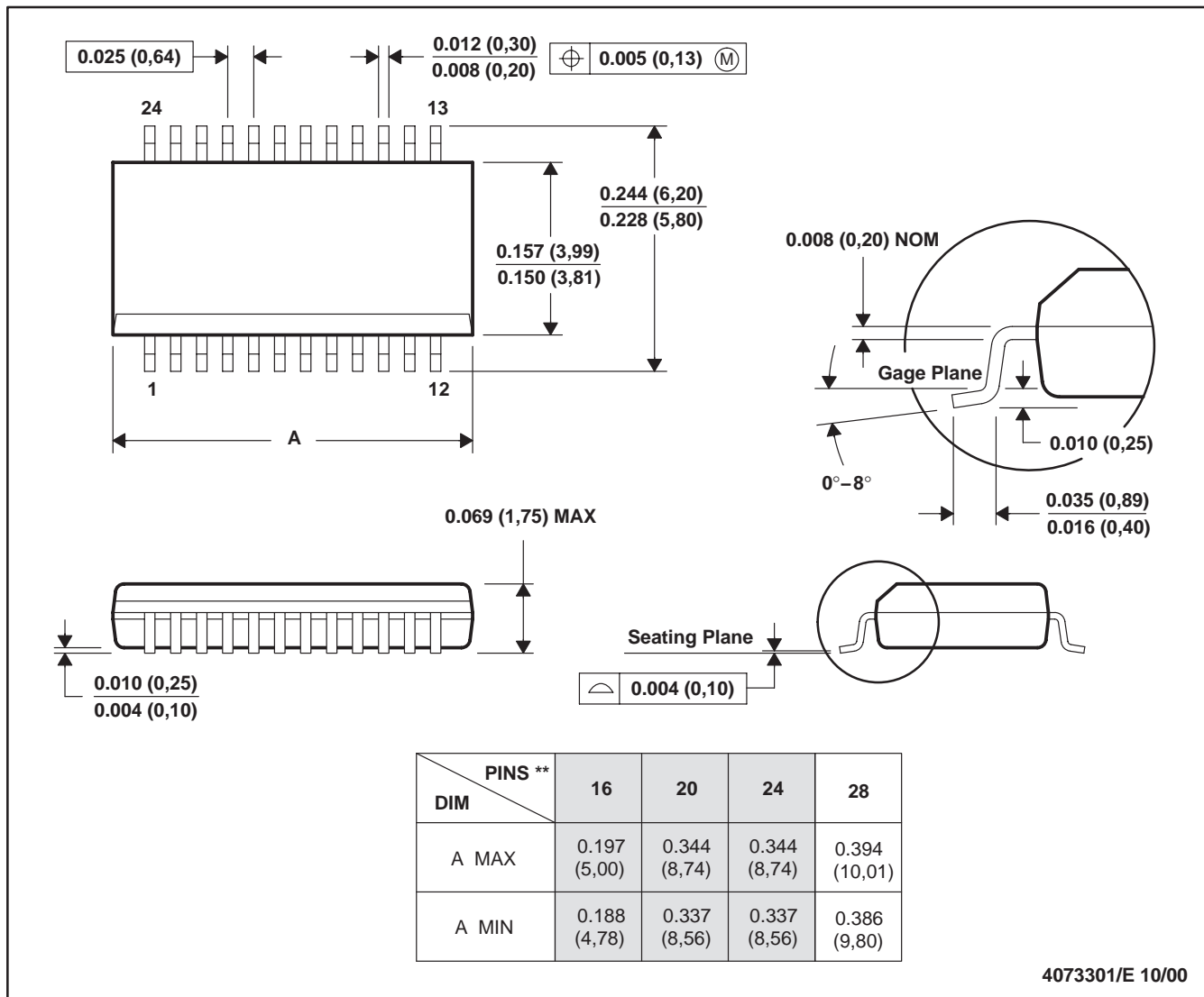

- NOTES: A. All linear dimensions are in inches (millimeters).
 B. This drawing is subject to change without notice.
 C. Body dimensions do not include mold flash or protrusion not to exceed 0.006 (0,15).
 D. Falls within JEDEC MO-137

PACKAGING INFORMATION

Orderable Device	Status (1)	Package Type	Package Drawing	Pins	Package Qty	Eco Plan (2)	Lead/Ball Finish (6)	MSL Peak Temp (3)	Op Temp (°C)	Device Marking (4/5)	Samples
BQ2063DBQ	NRND	SSOP	DBQ	28	40	Green (RoHS & no Sb/Br)	CU NIPDAU	Level-2-260C-1 YEAR	0 to 70	2063 E616	
BQ2063DBQG4	NRND	SSOP	DBQ	28	40	Green (RoHS & no Sb/Br)	CU NIPDAU	Level-2-260C-1 YEAR	0 to 70	2063 E616	

(1) The marketing status values are defined as follows:

ACTIVE: Product device recommended for new designs.

LIFEBUY: TI has announced that the device will be discontinued, and a lifetime-buy period is in effect.

NRND: Not recommended for new designs. Device is in production to support existing customers, but TI does not recommend using this part in a new design.

PREVIEW: Device has been announced but is not in production. Samples may or may not be available.

OBSELETE: TI has discontinued the production of the device.

(2) Eco Plan - The planned eco-friendly classification: Pb-Free (RoHS), Pb-Free (RoHS Exempt), or Green (RoHS & no Sb/Br) - please check <http://www.ti.com/productcontent> for the latest availability information and additional product content details.

TBD: The Pb-Free/Green conversion plan has not been defined.

Pb-Free (RoHS): TI's terms "Lead-Free" or "Pb-Free" mean semiconductor products that are compatible with the current RoHS requirements for all 6 substances, including the requirement that lead not exceed 0.1% by weight in homogeneous materials. Where designed to be soldered at high temperatures, TI Pb-Free products are suitable for use in specified lead-free processes.

Pb-Free (RoHS Exempt): This component has a RoHS exemption for either 1) lead-based flip-chip solder bumps used between the die and package, or 2) lead-based die adhesive used between the die and leadframe. The component is otherwise considered Pb-Free (RoHS compatible) as defined above.

Green (RoHS & no Sb/Br): TI defines "Green" to mean Pb-Free (RoHS compatible), and free of Bromine (Br) and Antimony (Sb) based flame retardants (Br or Sb do not exceed 0.1% by weight in homogeneous material)

(3) MSL, Peak Temp. - The Moisture Sensitivity Level rating according to the JEDEC industry standard classifications, and peak solder temperature.

(4) There may be additional marking, which relates to the logo, the lot trace code information, or the environmental category on the device.

(5) Multiple Device Markings will be inside parentheses. Only one Device Marking contained in parentheses and separated by a "~" will appear on a device. If a line is indented then it is a continuation of the previous line and the two combined represent the entire Device Marking for that device.

(6) Lead/Ball Finish - Orderable Devices may have multiple material finish options. Finish options are separated by a vertical ruled line. Lead/Ball Finish values may wrap to two lines if the finish value exceeds the maximum column width.

Important Information and Disclaimer:The information provided on this page represents TI's knowledge and belief as of the date that it is provided. TI bases its knowledge and belief on information provided by third parties, and makes no representation or warranty as to the accuracy of such information. Efforts are underway to better integrate information from third parties. TI has taken and continues to take reasonable steps to provide representative and accurate information but may not have conducted destructive testing or chemical analysis on incoming materials and chemicals. TI and TI suppliers consider certain information to be proprietary, and thus CAS numbers and other limited information may not be available for release.

In no event shall TI's liability arising out of such information exceed the total purchase price of the TI part(s) at issue in this document sold by TI to Customer on an annual basis.

IMPORTANT NOTICE

Texas Instruments Incorporated and its subsidiaries (TI) reserve the right to make corrections, enhancements, improvements and other changes to its semiconductor products and services per JESD46, latest issue, and to discontinue any product or service per JESD48, latest issue. Buyers should obtain the latest relevant information before placing orders and should verify that such information is current and complete. All semiconductor products (also referred to herein as "components") are sold subject to TI's terms and conditions of sale supplied at the time of order acknowledgment.

TI warrants performance of its components to the specifications applicable at the time of sale, in accordance with the warranty in TI's terms and conditions of sale of semiconductor products. Testing and other quality control techniques are used to the extent TI deems necessary to support this warranty. Except where mandated by applicable law, testing of all parameters of each component is not necessarily performed.

TI assumes no liability for applications assistance or the design of Buyers' products. Buyers are responsible for their products and applications using TI components. To minimize the risks associated with Buyers' products and applications, Buyers should provide adequate design and operating safeguards.

TI does not warrant or represent that any license, either express or implied, is granted under any patent right, copyright, mask work right, or other intellectual property right relating to any combination, machine, or process in which TI components or services are used. Information published by TI regarding third-party products or services does not constitute a license to use such products or services or a warranty or endorsement thereof. Use of such information may require a license from a third party under the patents or other intellectual property of the third party, or a license from TI under the patents or other intellectual property of TI.

Reproduction of significant portions of TI information in TI data books or data sheets is permissible only if reproduction is without alteration and is accompanied by all associated warranties, conditions, limitations, and notices. TI is not responsible or liable for such altered documentation. Information of third parties may be subject to additional restrictions.

Resale of TI components or services with statements different from or beyond the parameters stated by TI for that component or service voids all express and any implied warranties for the associated TI component or service and is an unfair and deceptive business practice. TI is not responsible or liable for any such statements.

Buyer acknowledges and agrees that it is solely responsible for compliance with all legal, regulatory and safety-related requirements concerning its products, and any use of TI components in its applications, notwithstanding any applications-related information or support that may be provided by TI. Buyer represents and agrees that it has all the necessary expertise to create and implement safeguards which anticipate dangerous consequences of failures, monitor failures and their consequences, lessen the likelihood of failures that might cause harm and take appropriate remedial actions. Buyer will fully indemnify TI and its representatives against any damages arising out of the use of any TI components in safety-critical applications.

In some cases, TI components may be promoted specifically to facilitate safety-related applications. With such components, TI's goal is to help enable customers to design and create their own end-product solutions that meet applicable functional safety standards and requirements. Nonetheless, such components are subject to these terms.

No TI components are authorized for use in FDA Class III (or similar life-critical medical equipment) unless authorized officers of the parties have executed a special agreement specifically governing such use.

Only those TI components which TI has specifically designated as military grade or "enhanced plastic" are designed and intended for use in military/aerospace applications or environments. Buyer acknowledges and agrees that any military or aerospace use of TI components which have **not** been so designated is solely at the Buyer's risk, and that Buyer is solely responsible for compliance with all legal and regulatory requirements in connection with such use.

TI has specifically designated certain components as meeting ISO/TS16949 requirements, mainly for automotive use. In any case of use of non-designated products, TI will not be responsible for any failure to meet ISO/TS16949.

Products

Audio	www.ti.com/audio
Amplifiers	amplifier.ti.com
Data Converters	dataconverter.ti.com
DLP® Products	www.dlp.com
DSP	dsp.ti.com
Clocks and Timers	www.ti.com/clocks
Interface	interface.ti.com
Logic	logic.ti.com
Power Mgmt	power.ti.com
Microcontrollers	microcontroller.ti.com
RFID	www.ti-rfid.com
OMAP Applications Processors	www.ti.com/omap
Wireless Connectivity	www.ti.com/wirelessconnectivity

Applications

Automotive and Transportation	www.ti.com/automotive
Communications and Telecom	www.ti.com/communications
Computers and Peripherals	www.ti.com/computers
Consumer Electronics	www.ti.com/consumer-apps
Energy and Lighting	www.ti.com/energy
Industrial	www.ti.com/industrial
Medical	www.ti.com/medical
Security	www.ti.com/security
Space, Avionics and Defense	www.ti.com/space-avionics-defense
Video and Imaging	www.ti.com/video

TI E2E Community

e2e.ti.com