

## System-on-Chip for 2.4-GHz RF Applications

### FEATURES

- **RF section**
  - Single-Chip 2.4-GHz RF Transceiver and MCU
  - Supports 250 kbps, 500 kbps, 1 Mbps and 2 Mbps data rates
  - Excellent Link Budget, Enabling Long Range Without External Front-Ends
  - Programmable Output Power up to 4 dBm
  - Excellent Receiver Sensitivity (–90 dBm at 2 Mbps, –98 dBm at 250 kbps)
  - Suitable for Systems Targeting Compliance With Worldwide Radio Frequency Regulations: ETSI EN 300 328 and EN 300 440 Category 2 (Europe), FCC CFR47 Part 15 (US), and ARIB STD-T66 (Japan)
  - Accurate RSSI Function
- **Layout**
  - Few External Components
  - Pin Out Suitable for Single Layer PCB Applications
  - Reference Designs Available
  - 48-pin 7-mm × 7-mm QFN (31 General I/O Pins) Package
- **Low Power**
  - Active Mode RX Best Performance: 20.8 mA
  - Active Mode TX (0 dBm): 26.3 mA
  - Power Mode 1 (5 μs Wake-Up): 235 μA
  - Power mode 2 (sleep timer on): 0.9 μA
  - Power mode 3 (External interrupts): 0.4 μA
  - Wide Supply Voltage Range (2V to 3.6V)
  - Full RAM and Register Retention in All Power Modes
- **Microcontroller**
  - High-Performance and Low-Power 8051 Microcontroller Core With Code Prefetch
  - 32-KB Flash Program Memory
  - 1 KB SRAM
  - Hardware Debug Support
  - Extensive Baseband Automation, Including Auto-Acknowledgement and Address Decoding
- **Peripherals**
  - Two-Channel DMA with Access to all Memory Areas and Peripherals
  - General-Purpose Timers (One 16-Bit, Two 8-Bit)
  - Radio Timer, 40-Bit
  - IR Generation Circuitry
  - Several Oscillators:
    - 32MHz XOSC
    - 16MHz RCOSC
    - 32kHz XOSC
    - 32kHz RCOSC
  - 32-kHz Sleep Timer With Capture
  - AES Security Coprocessor
  - UART/SPI/I<sup>2</sup>C Serial Interface
  - 31 General-Purpose I/O pins (3 × 20-mA Drive Strength, Remaining pins have 4 mA Drive Strength)
  - Watchdog Timer
  - True Random-Number Generator
  - ADC and Analog Comparator

### APPLICATIONS

- Proprietary 2.4-GHz Systems
- Human Interface Devices (keyboard, mouse)
- Consumer Electronics



Please be aware that an important notice concerning availability, standard warranty, and use in critical applications of Texas Instruments semiconductor products and disclaimers thereto appears at the end of this data sheet.



This integrated circuit can be damaged by ESD. Texas Instruments recommends that all integrated circuits be handled with appropriate precautions. Failure to observe proper handling and installation procedures can cause damage.

ESD damage can range from subtle performance degradation to complete device failure. Precision integrated circuits may be more susceptible to damage because very small parametric changes could cause the device not to meet its published specifications.

## DESCRIPTION

The CC2545 is an optimized system-on-chip (SoC) solution with data rates up to 2Mbps built with low bill-of-material cost. The CC2545 combines the excellent performance of a leading RF transceiver with a single-cycle 8051 compliant CPU, 32-KB in-system programmable flash memory, up to 1-KB RAM, 31 General-Purpose I/O pins and many other powerful features. The CC2545 has efficient power modes with RAM and register retention below 1  $\mu$ A, making it highly suited for low-duty-cycle systems where ultralow power consumption is required. Short transition times between operating modes further ensure low energy consumption.

The CC2545 is compatible with the CC2541/CC2543/CC2544. It comes in a 7-mm  $\times$  7-mm QFN48 package, with SPI/UART/I2C interface. The CC2545 comes complete with reference designs from Texas Instruments.

The device targets wireless consumer and HID applications. The CC2545 is tailored for peripheral devices such as wireless keyboards.

For block diagram, see [Figure 7](#)

## ABSOLUTE MAXIMUM RATINGS<sup>(1)</sup>

over operating free-air temperature range (unless otherwise noted)

PARAMETER	TEST CONDITIONS	MIN	MAX	UNIT
Supply voltage VDD	All supply pins must have the same voltage	-0.3	3.9	V
Voltage on any digital pin		-0.3	VDD+0.3 $\leq$ 3.9	V
Input RF level			10	dBm
Storage temperature range		-40	125	$^{\circ}$ C
ESD <sup>(2)</sup>	All pads, according to human-body model, JEDEC STD 22, method A114 (HBM)		2000	V
	According to charged-device model, JEDEC STD 22, method C101 (CDM)		750	V

- (1) Stresses beyond those listed under *Absolute Maximum Ratings* may cause permanent damage to the device. These are stress ratings only, and functional operation of the device at these or any other conditions beyond those indicated under *Recommended Operating Conditions* is not implied. Exposure to absolute-maximum-rated conditions for extended periods may affect device reliability.
- (2) CAUTION: ESD sensitive device. Precaution should be used when handling the device in order to prevent permanent damage.

## RECOMMENDED OPERATING CONDITIONS

PARAMETER	TEST CONDITIONS	MIN	MAX	UNIT
Operating ambient temperature range, T <sub>A</sub>		-40	85	$^{\circ}$ C
Operating supply voltage VDD	All supply pins must have same voltage	2.0	3.6	V

## ELECTRICAL CHARACTERISTICS

 Measured on Texas Instruments CC2545EM reference design with  $T_A = 25^\circ\text{C}$  and  $V_{DD} = 3.0\text{ V}$ , unless otherwise noted.

PARAMETER	TEST CONDITIONS	MIN	TYP	MAX	UNIT
	<b>2 Mbps, GFSK, 320-kHz deviation</b>				
$I_{\text{core}}$ – Core current consumption	RX mode, no peripherals active, low MCU activity		20.8		mA
	TX mode, 0-dBm output power, no peripherals active, low MCU activity		26.3		mA
	TX mode, 5-dBm output power, no peripherals active, low MCU activity		30.2		mA
	Active mode, 16-MHz RCOSC, Low MCU activity		3		mA
	Active mode, 32-MHz clock frequency, low MCU activity		6		mA
	Power mode 0, CPU clock halted, all peripherals on, no clock division, 32-MHz crystal selected		4.5		mA
	Power mode 0, CPU clock halted, all peripherals on, clock division at max (Limits max speed in peripherals except radio), 32-MHz crystal selected		3		mA
	Power mode 1. Digital regulator ON; 16-MHz RCOSC and 32-MHz crystal oscillator OFF; 32.753-kHz RCOSC, POR, BOD, and sleep timer active; RAM and register retention		235		$\mu\text{A}$
	Power mode 2. Digital regulator OFF, 16 MHz RCOSC and 32 MHz crystal oscillator OFF; 32.753 kHz RCOSC, POR and sleep timer active; RAM and register retention		0.9		$\mu\text{A}$
	Power mode 3. Digital regulator OFF, no clocks, POR active; RAM and register retention		0.4		$\mu\text{A}$
$I_{\text{peri}}$ – Peripheral current consumption (Adds to core current $I_{\text{core}}$ for each peripheral unit activated)	Timer 1 (16-bit). Timer running, 32-MHz XOSC used		90		$\mu\text{A}$
	Radio timer(40 bit). Timer running, 32-MHz XOSC used		90		$\mu\text{A}$
	Timer 3 (8-bit). Timer running, 32-MHz XOSC used		60		$\mu\text{A}$
	Timer 4 (8-bit). Timer running, 32-MHz XOSC used		70		$\mu\text{A}$
	Sleep timer. Including 32.753-kHz RCOSC		0.6		$\mu\text{A}$

## GENERAL CHARACTERISTICS

 Measured on Texas Instruments CC2545EM reference design with  $T_A = 25^\circ\text{C}$  and  $V_{DD} = 3.0\text{ V}$ , unless otherwise noted.

PARAMETER	TEST CONDITIONS	MIN	TYP	MAX	UNIT
<b>WAKE-UP AND TIMING</b>					
Power mode 1 → Active	Digital regulator on, 16-MHz RCOSC and 32-MHz crystal oscillator off. Start-up of 16-MHz RCOSC.		5		$\mu\text{s}$
Power mode 2 or 3 → Active	Digital regulator off, 16 MHz RCOSC and 32 MHz crystal oscillator off. Start-up of regulator and 16 MHz RCOSC.		130		$\mu\text{s}$
Active → TX or RX	Crystal ESR = 16 $\Omega$ . Initially running on 16-MHz RCOSC, with 32-MHz XOSC OFF.		500		$\mu\text{s}$
	With 32-MHz XOSC initially ON.		180		$\mu\text{s}$
RX/TX turnaround	RCOSC, with 32MHz XOSC OFF.		130		$\mu\text{s}$
<b>RADIO PART</b>					
RF frequency range	Programmable in 1-MHz steps	2379		2496	MHz
Data rates and modulation formats	2 Mbps, GFSK 320-kHz deviation 2-Mbps, GFSK 500 kHz deviation 1-Mbps, GFSK 250 kHz deviation 1-Mbps, GFSK 160 kHz deviation 500 kbps, MSK 250 kbps, MSK 250 kbps, GSK 160 kHz deviation				

## RF RECEIVE SECTION

Measured on Texas Instruments CC2545EM reference design with  $T_A = 25^\circ\text{C}$ ,  $V_{DD} = 3\text{ V}$ , and  $f_c = 2440\text{ MHz}$ , unless otherwise noted.

PARAMETER	TEST CONDITIONS	MIN	TYP	MAX	UNIT
<b>2 Mbps, GFSK, 320-kHz DEVIATION, 0.1% BER</b>					
Receiver sensitivity			-86		dBm
Saturation			-8		dBm
Co-channel rejection	Wanted signal at -67 dBm		-13		dB
In-band blocking rejection	$\pm 2$ -MHz offset, wanted signal at -67 dBm		-1		dB
	$\pm 4$ -MHz offset, wanted signal at -67 dBm		34		
	$> \pm 6$ -MHz offset, wanted signal at -67 dBm		38		
Out-of-band blocking rejection	1-MHz resolution. Wanted signal at -67 dBm, $f < 2\text{ GHz}$ Two exception frequencies with poorer performance		-32		dBm
	1-MHz resolution. Wanted signal at -67 dBm, $2\text{ GHz} > f < 3\text{ GHz}$ Two exception frequencies with poorer performance		-38		
	1-MHz resolution. Wanted signal at -67 dBm, $f > 3\text{ GHz}$ Two exception frequencies with poorer performance		-12		
Intermodulation	Wanted signal at -64 dBm, 1 <sup>st</sup> interferer is CW, 2 <sup>nd</sup> interferer is GFSK-modulated signal. Offsets of interferers are: 6 and 12 MHz 8 and 16 MHz 10 and 20 MHz		-43		dBm
Frequency error tolerance <sup>(1)</sup>	Including both initial tolerance and drift. Sensitivity better than -70 dBm. 250 byte payload.	-300		300	kHz
Symbol rate error tolerance <sup>(2)</sup>	Sensitivity better than -70 dBm. 250 byte payload.	-120		120	ppm
<b>2 Mbps, GFSK, 500 kHz DEVIATION, 0.1% BER</b>					
Receiver sensitivity			-90		dBm
Saturation			-3		dBm
Co-channel rejection	Wanted signal at -67 dBm		-10		dB
In-band blocking rejection	$\pm 2$ MHz offset, wanted signal at -67 dBm		-3		dB
	$\pm 4$ MHz offset, wanted signal at -67 dBm		36		dB
	$> \pm 6$ MHz offset, wanted signal at -67 dBm		44		dB
Frequency error tolerance <sup>(1)</sup>	Including both initial tolerance and drift. Sensitivity better than -70 dBm. 250 byte payload.	-300		300	kHz
Symbol rate error tolerance <sup>(2)</sup>	Sensitivity better than -70 dBm. 250 byte payload.	-120		120	ppm
<b>1 Mbps, GFSK, 250 kHz DEVIATION, 0.1% BER</b>					
Receiver sensitivity			-94		dBm
Saturation			6		dBm
Co-channel rejection	Wanted signal at -67 dBm		-7		dB
In-band blocking rejection	$\pm 1$ MHz offset, wanted signal -67 dBm		0		dB
	$\pm 2$ MHz offset, wanted signal -67 dBm		30		
	$\pm 3$ MHz offset, wanted signal -67 dBm		34		
	$> \pm 5$ MHz offset, wanted signal -67 dBm		38		
Frequency error tolerance	Including both initial tolerance and drift. Sensitivity better than -70 dBm. 250 byte payload.	-250		250	kHz
Symbol rate error tolerance	Sensitivity better than -70 dBm. 250 byte payload.	-80		80	ppm

(1) Difference between center frequency of the received RF signal and local oscillator frequency

(2) Difference between incoming symbol rate and the internally generated symbol rate

**RF RECEIVE SECTION (continued)**

 Measured on Texas Instruments CC2545EM reference design with  $T_A = 25^\circ\text{C}$ ,  $V_{DD} = 3\text{ V}$ , and  $f_c = 2440\text{ MHz}$ , unless otherwise noted.

PARAMETER	TEST CONDITIONS	MIN	TYP	MAX	UNIT
<b>1 Mbps, GFSK, 160 kHz DEVIATION, 0.1% BER</b>					
Receiver sensitivity			-91		dBm
Saturation			6		dBm
Co-channel rejection	Wanted signal at -67 dBm		-8		dB
In band blocking rejection	$\pm 1$ MHz offset, wanted signal at -67 dBm		2		dB
	$\pm 2$ MHz offset, wanted signal at -67 dBm		28		
	$\pm 3$ MHz offset, wanted signal at -67 dBm		33		
	$> \pm 5$ MHz offset, wanted signal at -67 dBm		36		
Frequency error tolerance	Including both initial tolerance and drift, Sensitivity better than -67 dBm	-250		250	kHz
Symbol rate error tolerance	Maximum packet length	-80		80	ppm
<b>500 kbps, MSK, 0.1% BER</b>					
Receiver sensitivity			-98		dBm
Saturation			6		dBm
Co-channel rejection	Wanted signal at -67 dBm		-5		dB
In band blocking rejection	$\pm 1$ MHz offset, wanted signal at -67 dBm		21		dB
	$\pm 2$ MHz offset, wanted signal at -67 dBm		32		
	$> \pm 2$ MHz offset, wanted signal at -67 dBm		33		
Frequency error tolerance	Including both initial tolerance and drift, Sensitivity better than -67 dBm	-150		150	kHz
Symbol rate error tolerance	Maximum packet length	-60		60	ppm
<b>250 kbps, GFSK, 160 kHz DEVIATION , 0.1% BER</b>					
Receiver sensitivity			-98		dBm
Saturation			6		dBm
Co-channel rejection	Wanted signal at -67 dBm		-2		dB
In-band blocking rejection	$\pm 1$ MHz offset, wanted signal at -67 dBm		22		dB
	$\pm 2$ MHz offset, wanted signal at -67 dBm		32		
	$> \pm 2$ MHz offset, wanted signal at -67 dBm		32		
Frequency error tolerance	Including both initial tolerance and drift, Sensitivity better than -67 dBm	-150		150	kHz
Symbol rate error tolerance	Maximum packet length	-60		60	ppm
<b>250 kbps, MSK, 0.1% BER</b>					
Receiver sensitivity			-98		dBm
Saturation			6		dBm
Co-channel rejection	Wanted signal at -67 dBm		-5		dB
In-band blocking rejection	$\pm 1$ MHz offset, wanted signal at -67 dBm		21		dB
	$\pm 2$ MHz offset, wanted signal at -67 dBm		32		
	$> 2$ MHz offset, wanted signal at -67 dBm		33		
Frequency error tolerance	Including both initial tolerance and drift, Sensitivity better than -67 dBm	-150		150	kHz
Symbol rate error tolerance	Maximum packet length	-60		60	ppm
<b>ALL RATES/FORMATS</b>					
Spurious emission in RX. Conducted measurement	$f < 1\text{ GHz}$		-67		dBm
Spurious emission in RX. Conducted measurement	$f > 1\text{ GHz}$		-60		dBm

## RF TRANSMIT SECTION

Measured on Texas Instruments CC2545EM reference design with  $T_A = 25^\circ\text{C}$ ,  $V_{DD} = 3.0\text{ V}$ , and  $f_C = 2440\text{ MHz}$ , unless otherwise noted.

PARAMETER	TEST CONDITIONS	MIN	TYP	MAX	UNIT
Output power, maximum setting	Delivered to a single-ended 50- $\Omega$ load through a balun using maximum recommended output power setting.		5		dBm
Output power, minimum setting	Delivered to a single-ended 50- $\Omega$ load through a balun using minimum recommended output power setting.		-20		dBm
Programmable output power range	Delivered to a single-ended 50- $\Omega$ load through a balun.		25		dB
Spurious emission in TX. Conducted measurement	$f < 1\text{ GHz}$		-46		dBm
	$f > 1\text{ GHz}$		-44		dBm
	Suitable for Systems Targeting Compliance With Worldwide Radio Frequency Regulations: ETSI EN 300 328 and EN 300 440 Class 2 (Europe), FCC CFR47 Part 15 (US), and ARIB STD-T66 (Japan)				

Use a simple LC filter (1.6nH and 1.8pF in parallel to ground) to pass ETSI conducted requirements below 1GHz in restricted bands. For radiated measurements low antenna gain for these frequencies (depending on antenna design) can achieve the same attenuation of these low frequency components (see EM reference design).

## 32-MHz CRYSTAL OSCILLATOR

Measured on Texas Instruments CC2545EM reference design with  $T_A = 25^\circ\text{C}$ ,  $V_{DD} = 3.0\text{ V}$ , unless otherwise noted.

PARAMETER	TEST CONDITIONS	MIN	TYP	MAX	UNIT
Crystal frequency			32		MHz
Crystal frequency accuracy requirement	250 kbps and 500 kbps data rates 1 Mbps data rate 2 Mbps data rate	-30 -40 -60		30 40 60	ppm
Equivalent series resistance		6		60	$\Omega$
Crystal shunt capacitance		1		7	pF
Crystal load capacitance		10		16	pF
Start-up time			0.25		ms
Power-down guard time	The crystal oscillator must be in power down for a guard time before it is used again. This requirement is valid for all modes of operation. The need for power-down guard time can vary with crystal type and load.	3			ms

## 32.768-kHz CRYSTAL OSCILLATOR

Measured on Texas Instruments CC2545EM reference design with  $T_A = 25^\circ\text{C}$ ,  $V_{DD} = 3.0\text{ V}$ , unless otherwise noted.

PARAMETER	TEST CONDITIONS	MIN	TYP	MAX	UNIT
Crystal frequency			32.768		kHz
Crystal frequency accuracy requirement <sup>(1)</sup>		-100		+100	ppm
Equivalent series resistance			40	130	$\Omega$
Crystal shunt capacitance			0.9	2	pF
Crystal load capacitance			12	16	pF
Start-up time			0.4		s

(1) Crystal frequency accuracy requirement is highly dependent on application. Higher accuracy enables more accurate duty-cycling which in turn will reduce current consumption. The chip can handle much less accurate crystals.

### 32-kHz RC OSCILLATOR

Measured on Texas Instruments CC2545EM reference design with  $T_A = 25^\circ\text{C}$ ,  $V_{DD} = 3.0\text{ V}$ , unless otherwise noted.

PARAMETER	TEST CONDITIONS	MIN	TYP	MAX	UNIT
Calibrated frequency			32.753		kHz
Frequency accuracy after calibration			$\pm 0.2\%$		
Temperature coefficient			0.4		%/ $^\circ\text{C}$
Supply-voltage coefficient			3		%/V
Calibration time			2		ms

### 16-MHz RC OSCILLATOR

Measured on Texas Instruments CC2545EM reference design with  $T_A = 25^\circ\text{C}$ ,  $V_{DD} = 3.0\text{ V}$ , unless otherwise noted.

PARAMETER	TEST CONDITIONS	MIN	TYP	MAX	UNIT
Calibrated frequency			16		MHz
Uncalibrated frequency accuracy			$\pm 18\%$		
Frequency accuracy after calibration			$\pm 0.6\%$		
Start-up time			10		$\mu\text{s}$
Initial calibration time			50		$\mu\text{s}$

### RSSI CHARACTERISTICS

Measured on Texas Instruments CC2545EM reference design with  $T_A = 25^\circ\text{C}$ ,  $V_{DD} = 3\text{ V}$ , unless otherwise noted.

2Mbps, GFSK, 320-kHz Deviation, 0.1% BER and 2 Mbps, GFSK, 500-kHz Deviation, 0.1% BER				
RSSI range <sup>(1)</sup>	Reduced gain by AC algorithm		64	dB
	High gain by AGC algorithm		64	
RSSI offset <sup>(1)</sup>	Reduced gain by AGC algorithm		79	dBm
	High gain by AGC algorithm		99	
Absolute uncalibrated accuracy <sup>(1)</sup>			$\pm 3$	dB
Step size (LSB value)			1	dB
All Other Rates/Formats				
RSSI range <sup>(1)</sup>			64	dB
RSSI offset <sup>(1)</sup>			99	dBm
Absolute uncalibrated accuracy			$\pm 3$	dB
Step size (LSB value)			1	dB

(1) Assuming CC2545 EM reference design. Other RF designs give an offset from the reported value.

### FREQUENCY SYNTHESIZER CHARACTERISTICS

Measured on Texas Instruments CC2545EM reference design with  $T_A = 25^\circ\text{C}$ ,  $V_{DD} = 3.0\text{ V}$ , unless otherwise noted.

PARAMETER	TEST CONDITIONS	MIN	TYP	MAX	UNIT
Phase noise, unmodulated carrier	At $\pm 1\text{ MHz}$ from carrier		-112		dBc/Hz
	At $\pm 3\text{ MHz}$ from carrier		-119		
	At $\pm 5\text{ MHz}$ from carrier		-122		

## ANALOG TEMPERATURE SENSOR

Measured on Texas Instruments CC2545EM reference design with  $T_A = 25^\circ\text{C}$ ,  $V_{DD} = 3.0\text{ V}$  unless otherwise noted

PARAMETER	TEST CONDITIONS	MIN	TYP	MAX	UNIT
Output	Measured using integrated ADC, internal band-gap voltage reference, and maximum resolution		1480		12-bit
Temperature coefficient			4.5		/ 0.1°C
Voltage coefficient			1		/ 0.1V
Initial accuracy without calibration			±10		°C
Accuracy using 1-point calibration			±5		°C
Current consumption when enabled			0.5		mA

## COMPARATOR CHARACTERISTICS

$T_A = 25^\circ\text{C}$ ,  $V_{DD} = 3\text{ V}$ . All measurement results are obtained using the CC2545 reference designs, post-calibration.

PARAMETER	TEST CONDITIONS	MIN	TYP	MAX	UNIT
Common-mode maximum voltage			VDD		V
Common-mode minimum voltage			-0.3		
Input offset voltage			1		mV
Offset vs temperature			16		$\mu\text{V}/^\circ\text{C}$
Offset vs operating voltage			4		mV/V
Supply current			230		nA
Hysteresis			0.15		mV



## ADC CHARACTERISTICS

 $T_A = 25^\circ\text{C}$  and  $V_{DD} = 3\text{ V}$ 

PARAMETER		TEST CONDITIONS	MIN	TYP	MAX	UNIT
	Input voltage	VDD is voltage on AVDD5 pin	0		VDD	V
	External reference voltage	VDD is voltage on AVDD5 pin	0		VDD	V
	External reference voltage differential	VDD is voltage on AVDD5 pin	0		VDD	V
	Input resistance, signal	Simulated using 4-MHz clock speed		197		k $\Omega$
	Full-scale signal <sup>(1)</sup>	Peak-to-peak, defines 0 dBFS		2.97		V
ENOB <sup>(1)</sup>	Effective number of bits	Single-ended input, 7-bit setting		5.7		bits
		Single-ended input, 9-bit setting		7.5		
		Single-ended input, 10-bit setting		9.3		
		Single-ended input, 12-bit setting		10.3		
		Differential input, 7-bit setting		6.5		
		Differential input, 9-bit setting		8.3		
		Differential input, 10-bit setting		10		
		Differential input, 12-bit setting		11.5		
		10-bit setting, clocked by RCOSC		9.7		
		12-bit setting, clocked by RCOSC		10.9		
	Useful power bandwidth	7-bit setting, both single and differential		0–20		kHz
THD	Total harmonic distortion	Single ended input, 12-bit setting, –6 dBFS <sup>(1)</sup>		–75.2		dB
		Differential input, 12-bit setting, –6 dBFS <sup>(1)</sup>		–86.6		
	Signal to nonharmonic ratio	Single-ended input, 12-bit setting <sup>(1)</sup>		70.2		dB
		Differential input, 12-bit setting <sup>(1)</sup>		79.3		
		Single-ended input, 12-bit setting, –6 dBFS <sup>(1)</sup>		78.8		
		Differential input, 12-bit setting, –6 dBFS <sup>(1)</sup>		88.9		
CMRR	Common-mode rejection ratio	Differential input, 12-bit setting, 1-kHz sine (0 dBFS), limited by ADC resolution		>84		dB
	Crosstalk	Single ended input, 12-bit setting, 1-kHz sine (0 dBFS), limited by ADC resolution		>84		dB
	Offset	Midscale		–3		mV
	Gain error			0.68%		
DNL	Differential nonlinearity	12-bit setting, mean <sup>(1)</sup>		0.05		LSB
		12-bit setting, maximum <sup>(1)</sup>		0.9		
INL	Integral nonlinearity	12-bit setting, mean <sup>(1)</sup>		4.6		LSB
		12-bit setting, maximum <sup>(1)</sup>		13.3		
		12-bit setting, mean, clocked by RCOSC		10		
		12-bit setting, max, clocked by RCOSC		29		
SINAD (–THD+N)	Signal-to-noise-and-distortion	Single ended input, 7-bit setting <sup>(1)</sup>		35.4		dB
		Single ended input, 9-bit setting <sup>(1)</sup>		46.8		
		Single ended input, 10-bit setting <sup>(1)</sup>		57.5		
		Single ended input, 12-bit setting <sup>(1)</sup>		66.6		
		Differential input, 7-bit setting <sup>(1)</sup>		40.7		
		Differential input, 9-bit setting <sup>(1)</sup>		51.6		
		Differential input, 10-bit setting <sup>(1)</sup>		61.8		
		Differential input, 12-bit setting <sup>(1)</sup>		70.8		
	Conversion time	7-bit setting		20		$\mu\text{s}$
		9-bit setting		36		
		10-bit setting		68		
		12-bit setting		132		

(1) Measured with 300-Hz sine-wave input and VDD as reference.

### ADC CHARACTERISTICS (continued)

T<sub>A</sub> = 25°C and VDD = 3 V

PARAMETER	TEST CONDITIONS	MIN	TYP	MAX	UNIT
Power consumption			1.2		mA
Internal reference VDD coefficient			4		mV/V
Internal reference temperature coefficient			0.4		mV/10°C
Internal reference voltage			1.15		V

### DC CHARACTERISTICS

Measured on Texas Instruments CC2545EM reference design with T<sub>A</sub> = 25°C, VDD = 3.0 V, unless otherwise noted.<sup>(1)</sup>

PARAMETER	TEST CONDITIONS	MIN	TYP	MAX	UNIT
Logic-0 input voltage				0.5	V
Logic-1 input voltage		2.5			V
Logic-0 input current		-50		50	nA
Logic-1 input current		-50		50	nA
I/O pin pullup and pulldown resistors			20		kΩ
Logic-0 output voltage 4-mA pins	Output load 4 mA			0.5	V
Logic-1 output voltage 4-mA pins	Output load 4 mA	2.4			V
Logic-0 output voltage 20-mA pins	Output load 20 mA			0.5	V
Logic-1 output voltage, 20-mA pins	Output load 20 mA	2.4			V

(1) Note that only two of the three 20-mA pins can drive in the same direction at the same time, and toggle at the same time.

### CONTROL INPUT AC CHARACTERISTICS

T<sub>A</sub> = -40°C to 85°C, VDD = 2 V to 3.6 V.

PARAMETER	TEST CONDITIONS	MIN	TYP	MAX	UNIT
System clock, f <sub>SYSCLK</sub> t <sub>SYSCLK</sub> = 1/ f <sub>SYSCLK</sub>	The undivided system clock is 32 MHz when crystal oscillator is used. The undivided system clock is 16 MHz when calibrated 16-MHz RC oscillator is used.		16	32	MHz
RESET_N low duration	See item 1, Figure 1. This is the shortest pulse that is recognized as a complete reset pin request. Note that shorter pulses may be recognized but do not lead to complete reset of all modules within the chip.		1		μs
Interrupt pulse duration	See item 2, Figure 1. This is the shortest pulse that is recognized as an interrupt request.		20		ns

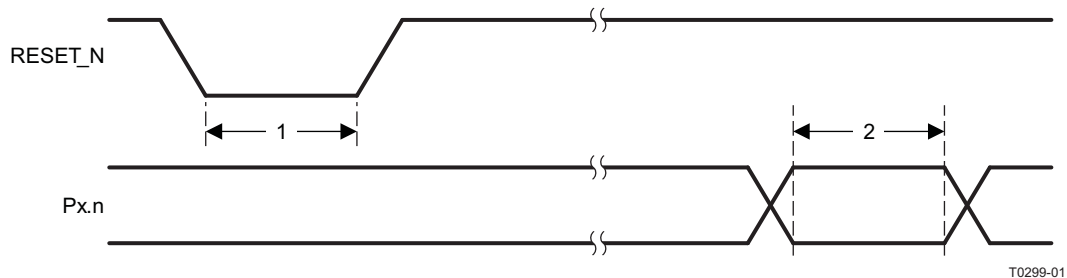

Figure 1. Control Input AC Characteristics

### SPI AC CHARACTERISTICS

T<sub>A</sub> = -40°C to 85°C, VDD = 2 V to 3.6 V

PARAMETER	TEST CONDITIONS	MIN	TYP	MAX	UNIT
t <sub>1</sub> SCK period	Master, RX and TX	250			ns
	Slave, RX and TX	250			
SCK duty cycle	Master		50%		
t <sub>2</sub> SSN low to SCK, Figure 2 and Figure 3	Master	63			ns
	Slave	63			
t <sub>3</sub> SCK to SSN high	Master	63			ns
	Slave	63			
t <sub>4</sub> MOSI early out	Master, load = 10 pF			7	ns
t <sub>5</sub> MOSI late out	Master, load = 10 pF			10	ns
t <sub>6</sub> MISO setup	Master	90			ns
t <sub>7</sub> MISO hold	Master	10			ns
SCK duty cycle	Slave		50%		ns
t <sub>10</sub> MOSI setup	Slave	35			ns
t <sub>11</sub> MOSI hold	Slave	10			ns
t <sub>8</sub> MISO early out	Slave, load = 10 pF			0	ns
t <sub>9</sub> MISO late out	Slave, load = 10 pF			95	ns
Operating frequency	Master, TX only			8	MHz
	Master, RX and TX			4	
	Slave, RX only			8	
	Slave, RX and TX			4	

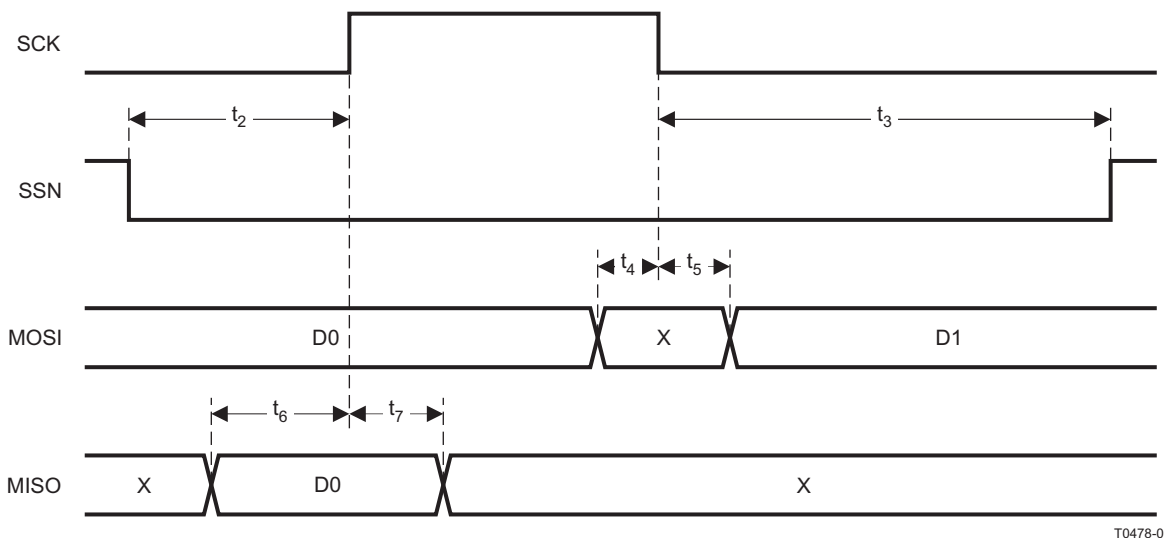

Figure 2. SPI Master AC Characteristics

T0478-01

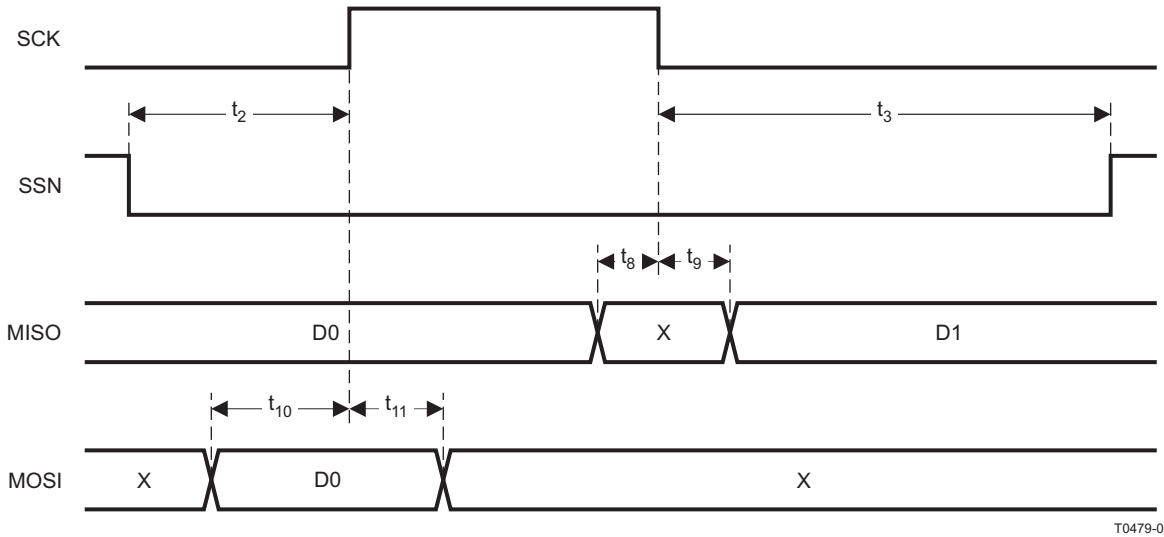

Figure 3. SPI Slave AC Characteristics

T0479-01

**DEBUG INTERFACE AC CHARACTERISTICS**

T<sub>A</sub> = -40°C to 85°C, VDD = 2 V to 3.6 V

PARAMETER	TEST CONDITIONS	MIN	TYP	MAX	UNIT
f <sub>clk_dbg</sub>	Debug clock frequency (see Figure 4)			12	MHz
t <sub>1</sub>	Allowed high pulse on clock (see Figure 4)	35			ns
t <sub>2</sub>	Allowed low pulse on clock (see Figure 4)	35			ns
t <sub>3</sub>	EXT_RESET_N low to first falling edge on debug clock (see Figure 5)	167			ns
t <sub>4</sub>	Falling edge on clock to EXT_RESET_N high (see Figure 5)	83			ns
t <sub>5</sub>	EXT_RESET_N high to first debug command (see Figure 5)	83			ns
t <sub>6</sub>	Debug data setup (see Figure 6)	2			ns
t <sub>7</sub>	Debug data hold (see Figure 6)	4			ns
t <sub>8</sub>	Clock-to-data delay (see Figure 6)			30	ns
	Load = 10 pF				

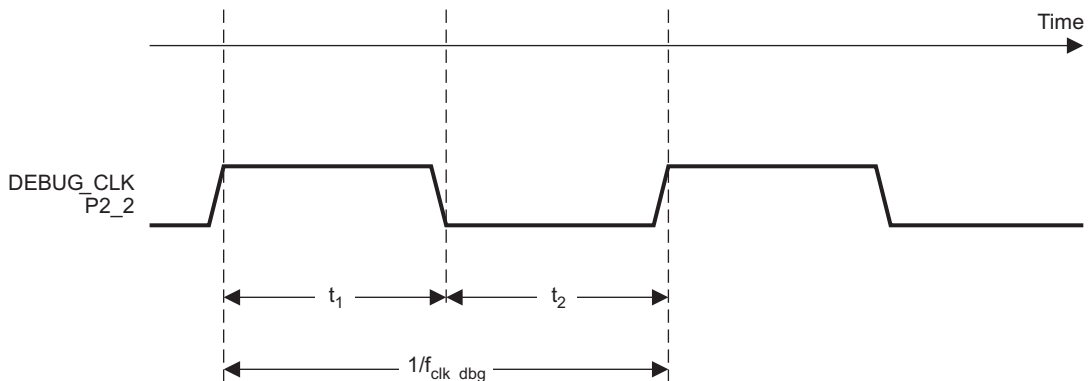
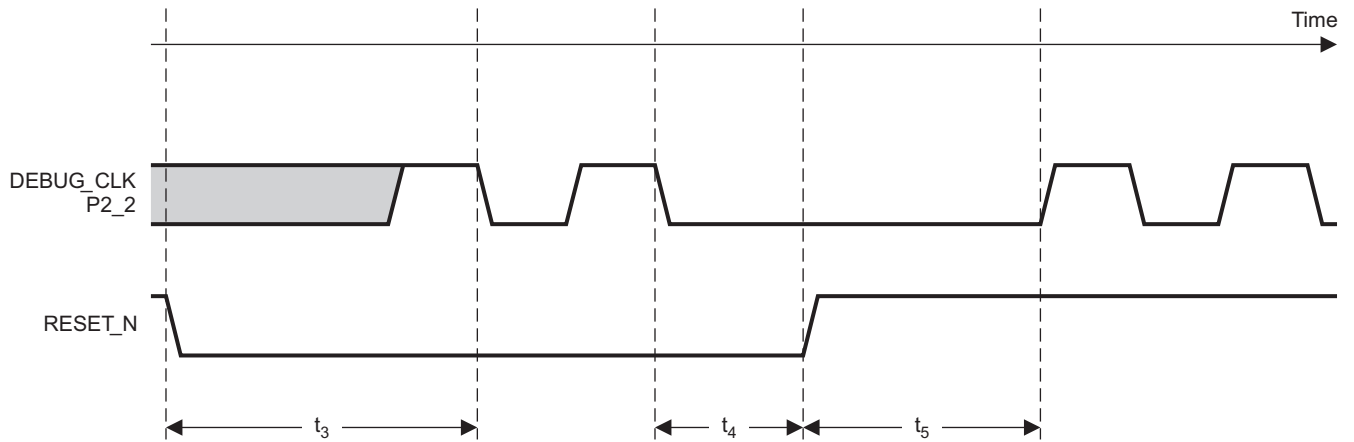

Figure 4. Debug Clock – Basic Timing

T0436-01



T0437-01

Figure 5. Debug Enable Timing

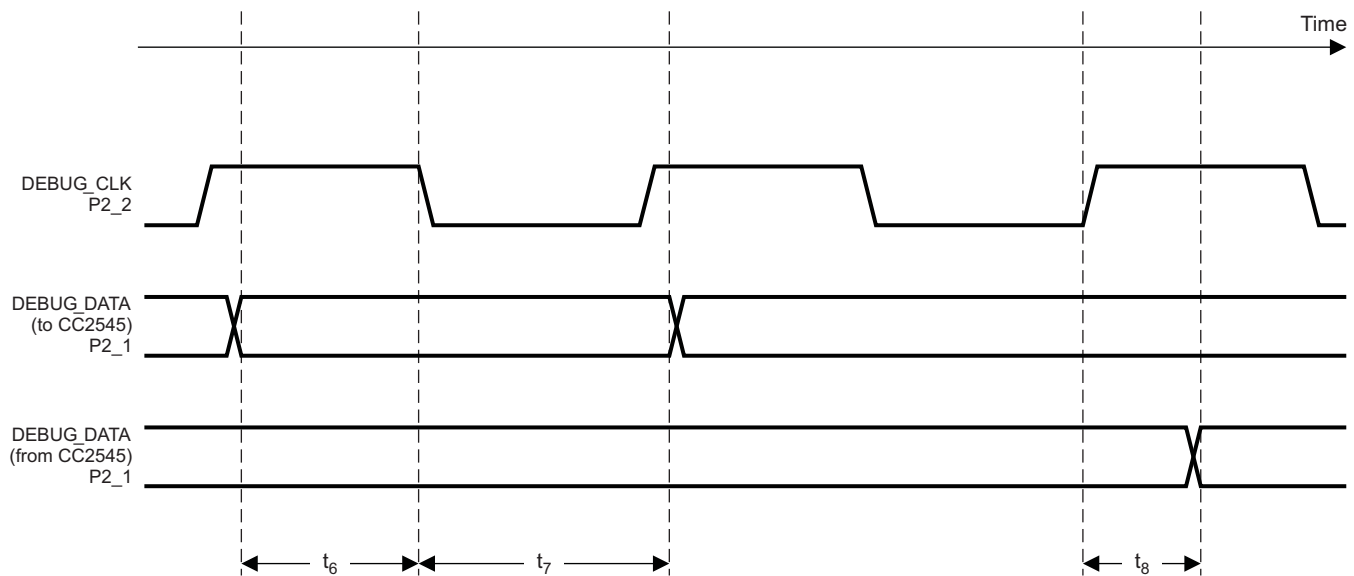

T0438-03

Figure 6. Data Setup and Hold Timing

**TIMER INPUTS AC CHARACTERISTICS**

T<sub>A</sub> = -40°C to 85°C, VDD = 2 V to 3.6 V

PARAMETER	TEST CONDITIONS	MIN	TYP	MAX	UNIT
Input capture pulse duration	Synchronizers determine the shortest input pulse that can be recognized. The synchronizers operate at the current system clock rate (16 MHz or 32 MHz).	1.5			t <sub>SYCLK</sub>



**Table 1. Pin Description Table (continued)**

NAME	PIN	PIN TYPE	DESCRIPTION
VDD	21	Power (analog)	2-V-3.6V analog power-supply connection
RESET_N	22	Digital input	Reset, active-low
P1_4/DC	23	Digital I/O / Debug	Port 1.4/Debug
P1_3/DD	24	Digital I/O / Debug	Port 1.3/Debug
VDD	25	Power (analog)	2-V-3.6V analog power-supply connection
XOSC_Q1	26	Analog I/O	32-MHz crystal oscillator pin 1 or external-clock input
XOSC_Q2	27	Analog I/O	32-MHz crystal oscillator pin 2
VDD	28	Power (analog)	2-V-3.6V analog power-supply connection
VSS	29	Unused pin	Connect to ground
RF_P	30	RF I/O	Positive RF input signal to LNA during RX Positive RF output signal from PA during TX
RF_N	31	RF I/O	Negative RF input signal to LNA during RX Negative RF output signal from PA during TX
VSS	32	Unused pin	Connect to ground
VDD	33	Power (analog)	2-V-3.6V analog power-supply connection
VDD	34	Power (analog)	2-V-3.6V analog power-supply connection
RBIAS	35	Analog I/O	External precision bias resistor for reference current
P1_6/ XOSC32K_ Q2	36	Digital I/O / Analog I/O	Port 1.6/32.768-kHz XOSC
P1_5/ XOSC32k_ Q1	37	Digital I/O / Analog I/O	Port 1.5/32.768-kHz XOSC
P1_2	38	Digital I/O	Port 1.2, 20mA
P1_1	39	Digital I/O	Port 1.1, 20mA
P1_0	40	Digital I/O	Port 1.0, 20mA
VDD	41	Power (analog)	2-V-3.6V analog power-supply connection
DCPL1	42	Power (digital)	1.8-V digital power-supply decoupling. Do not use for supplying external circuits.
VDD	43	Power (analog)	2-V-3.6V analog power-supply connection
VSS	44	Unused pin	Connect to ground
P3_7	45	Digital I/O	Port 3.7
P3_6	46	Digital I/O	Port 3.6
P3_5	47	Digital I/O	Port 3.5
P3_4	48	Digital I/O	Port 3.4
VSS	Ground Pad	Ground	Must be connected to solid ground as this is the main ground connection for the chip. See <a href="#">Pinout Diagram</a> .

### BLOCK DIAGRAM

A block diagram of the CC2545 is shown in Figure 7. The modules can be roughly divided into one of three categories: CPU-related modules; modules related to power, test, and clock distribution; and radio-related modules. In the following subsections, a short description of each module is given. See CC2543/44/45 User's Guide (SWRU283) for more details.

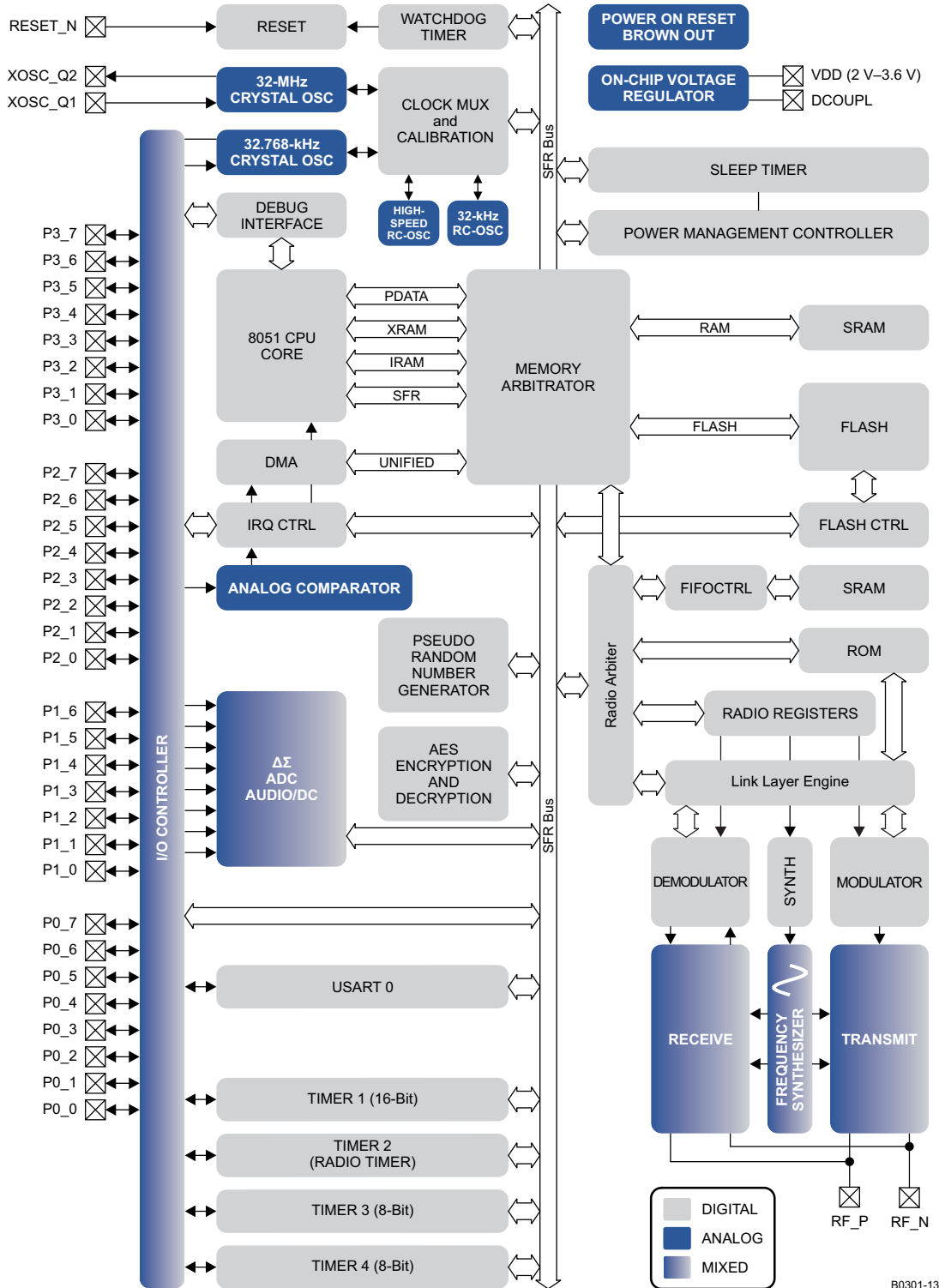

Figure 7. CC2545 Block Diagram



## BLOCK DESCRIPTIONS

### CPU and Memory

The **8051 CPU core** is a single-cycle 8051-compatible core. It has three different memory access busses (SFR, DATA, and CODE/XDATA), a debug interface, and an 15-input extended interrupt unit.

The **memory arbiter** is at the heart of the system, as it connects the CPU and DMA controller with the physical memories and all peripherals through the SFR bus. The memory arbiter has four memory-access points, access of which can map to one of three physical memories: an SRAM, flash memory, and XREG/SFR registers. It is responsible for performing arbitration and sequencing between simultaneous memory accesses to the same physical memory.

The **SFR bus** is drawn conceptually in [Figure 7](#) as a common bus that connects all hardware peripherals to the memory arbiter. The SFR bus in the block diagram also provides access to the radio registers in the radio register bank, even though these are indeed mapped into XDATA memory space.

The **1-KB SRAM** maps to the DATA memory space and to parts of the XDATA memory spaces.

The **18-KB/32-KB flash block** provides in-circuit programmable non-volatile program memory for the device, and maps into the CODE and XDATA memory spaces.

### Peripherals

Writing to the flash block is performed through a **flash controller** that allows page-wise erasure and 4-bitwise programming. See User Guide for details on the flash controller.

A versatile two-channel **DMA controller** is available in the system, accesses memory using the XDATA memory space, and thus has access to all physical memories. Each channel (trigger, priority, transfer mode, addressing mode, source and destination pointers, and transfer count) is configured with DMA descriptors that can be located anywhere in memory. Many of the hardware peripherals (AES core, flash controller, USART, timers, etc.) can be used with the DMA controller for efficient operation by performing data transfers between a single SFR or XREG address and flash/SRAM.

The **interrupt controller** services a total of 17 interrupt sources, divided into six interrupt groups, each of which is associated with one of four interrupt priorities. Any interrupt service request is serviced also when the device is in idle mode by going back to active mode. Some interrupts can also wake up the device from sleep mode (when in sleep mode, the device is in low-power mode PM1, PM2 or PM3).

The **debug interface** implements a proprietary two-wire serial interface that is used for in-circuit debugging. Through this debug interface, it is possible to perform an erasure of the entire flash memory, control which oscillators are enabled, stop and start execution of the user program, execute supplied instructions on the 8051 core, set code breakpoints, and single-step through instructions in the code. Using these techniques, it is possible to perform in-circuit debugging and external flash programming elegantly.

The **I/O controller** is responsible for all general-purpose I/O pins. The CPU can configure whether peripheral modules control certain pins or whether they are under software control, and if so, whether each pin is configured as an input or output and if a pullup or pulldown resistor in the pad is connected. Each peripheral that connects to the I/O pins can choose between several different I/O pin locations to ensure flexibility in various applications.

The **sleep timer** is an ultralow-power timer that can use either an external 32.768-kHz XOSC or an internal 32.753-kHz RC oscillator. The sleep timer runs continuously in all operating modes. Typical applications of this timer are as a real-time counter or as a wake-up timer to get out of power modes 1 or 2.

A built-in **watchdog timer** allows the CC2545 to reset itself if the firmware hangs. When enabled by software, the watchdog timer must be cleared periodically; otherwise, it resets the device when it times out.

**Timer 1** is a 16-bit timer with timer/counter/PWM functionality. It has a programmable prescaler, a 16-bit period value, and five individually programmable counter/capture channels, each with a 16-bit compare value. Each of the counter/capture channels can be used as a PWM output or to capture the timing of edges on input signals. It can also be configured in IR generation mode, where it counts timer 3 periods and the output is ANDed with the output of timer 3 to generate modulated consumer IR signals with minimal CPU interaction.

**Timer 2** is a 40-bit timer used by the Radio. It has a 16-bit counter with a configurable timer period and a 24-bit overflow counter that can be used to keep track of the number of periods that have transpired. A 40-bit capture register is also used to record the exact time at which a start-of-frame delimiter is received/transmitted or the exact time at which a packet ends. There are two 16-bit timer-compare registers and two 24-bit overflow-compare registers that can be used to give exact timing for start of RX or TX to the radio or general interrupts.

**Timer 3 and timer 4** are 8-bit timers with timer/counter/PWM functionality. They have a programmable prescaler, an 8-bit period value, and one programmable counter channel with an 8-bit compare value. Each of the counter channels can be used as PWM output.

**USART 0** is configurable as either an SPI master/slave or a UART. It provides double buffering on both RX and TX and hardware flow control and is thus well suited to high-throughput full-duplex applications. The USART has its own high-precision baud-rate generator, thus leaving the ordinary timers free for other uses. When configured as SPI slaves, the USART samples the input signal using SCK directly instead of using some oversampling scheme, and are thus well-suited for high data rates.

**I<sup>2</sup>C** module provides a digital peripheral connection with two pins and supports both master and slave operation.

The **AES encryption/decryption core** allows the user to encrypt and decrypt data using the AES algorithm with 128-bit keys. The AES core also supports ECB, CBC, CFB, OFB, CTR, and CBC-MAC, as well as hardware support for CCM.

The ultralow power **analog comparator** enables applications to wake up from PM2 or PM3 based on an analog signal. Both inputs are brought out to pins; the reference voltage must be provided externally. The comparator output is mapped into the digital I/O port and can be treated by the MCU as a regular digital input.

### TYPICAL CHARACTERISTICS

All curves are for measurements performed at 2Mbps, GFSK, 320-kHz deviation.

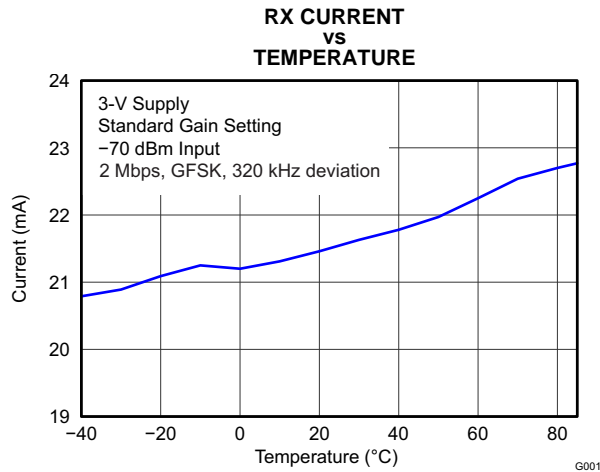

Figure 8.

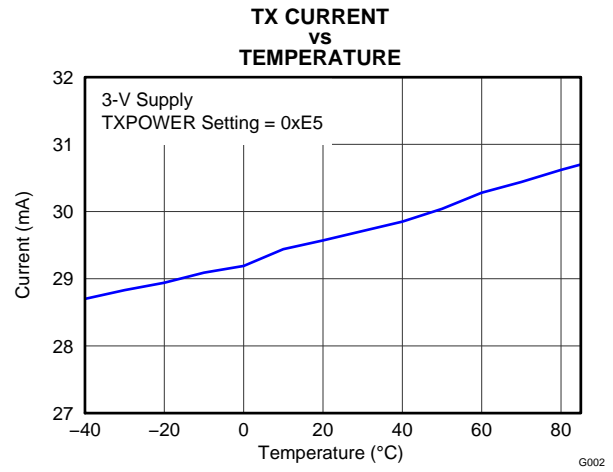

Figure 9.

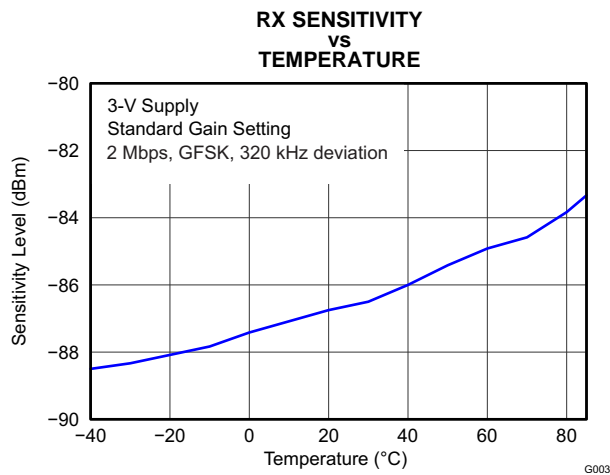

Figure 10.

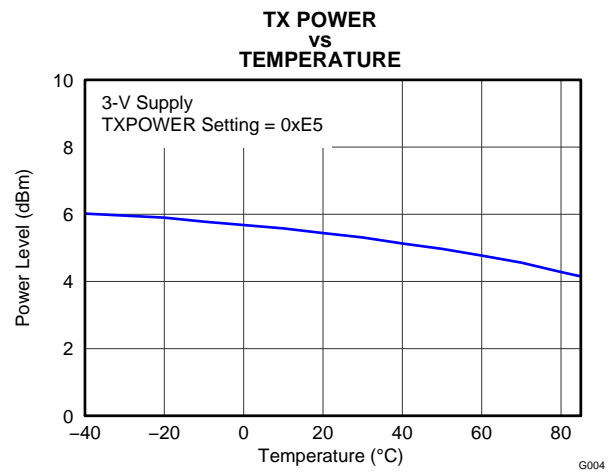

Figure 11.

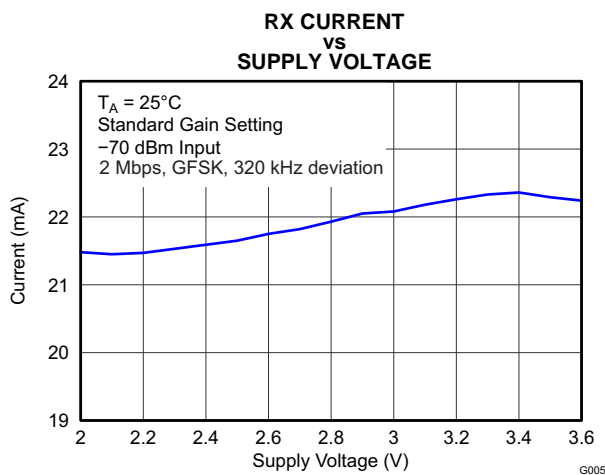

Figure 12.

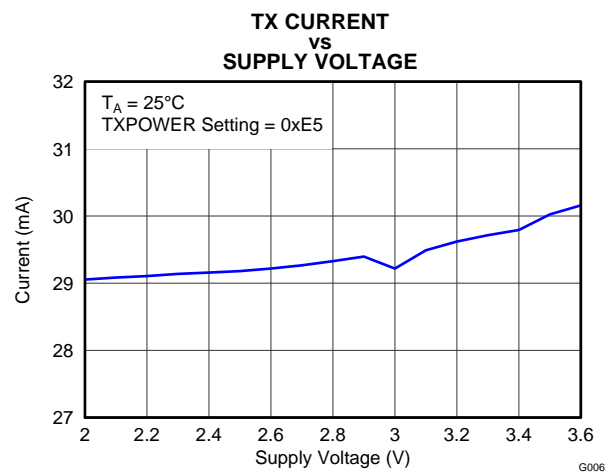
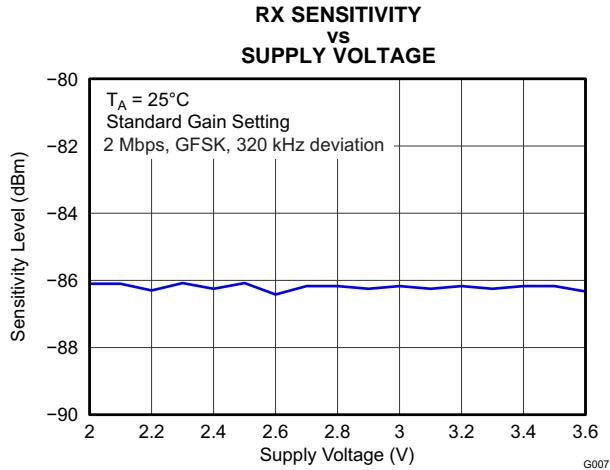

Figure 13.

**TYPICAL CHARACTERISTICS (continued)**

All curves are for measurements performed at 2Mbps, GFSK, 320-kHz deviation.



**Figure 14.**

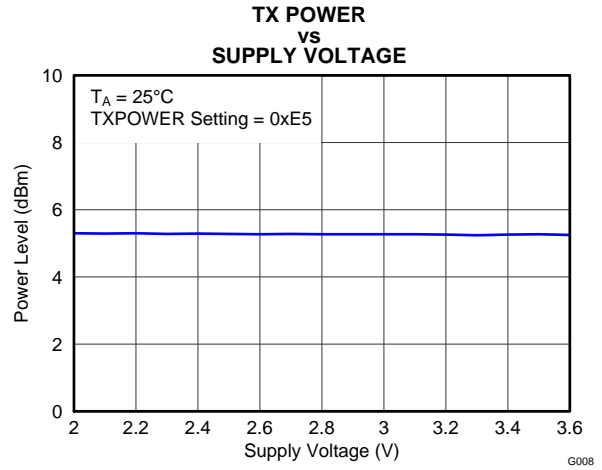

**Figure 15.**

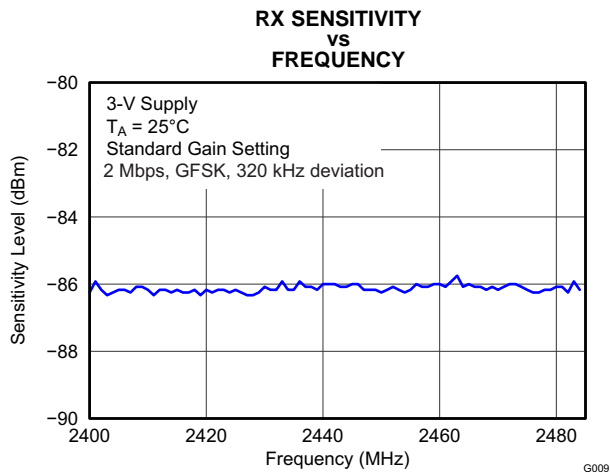

**Figure 16.**

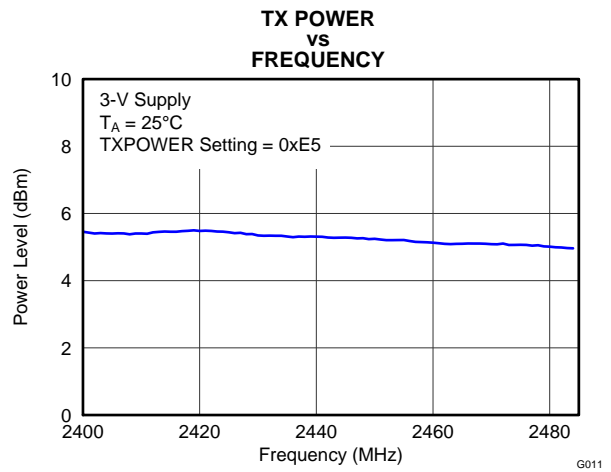

**Figure 17.**

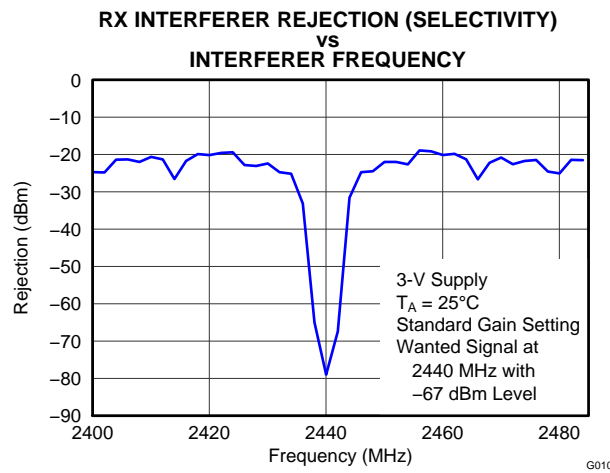

**Figure 18.**

**TYPICAL CHARACTERISTICS (continued)**  
**Table 2. Recommended Output Power Settings<sup>(1)</sup>**

TXPOWER Register Setting	Typical Output Power (dBm)
0xE5	5
0xD5	4
0xC5	3
0xB5	2
0xA5	0
0x95	-2
0x85	-3
0x75	-4
0x65	-6
0x55	-8
0x45	-11
0x35	-13
0x25	-15
0x15	-17
0x05	-20

(1) Measured on Texas Instruments CC2545 EM reference design with TA = 25°C, VDD = 3 V, and fc = 2440 MHz. See [SWRU283](#) for recommended register settings.

**APPLICATION INFORMATION**

**APPLICATION INFORMATION**

Few external components are required for the operation of the CC2545. A typical application circuit is shown in Figure 19. For suggestions of component values other than those listed in Table 3, see reference design CC2545EM. The performance stated in this data sheet is only valid for the CC2545EM reference design. To obtain similar performance, the reference design should be copied as closely as possible.

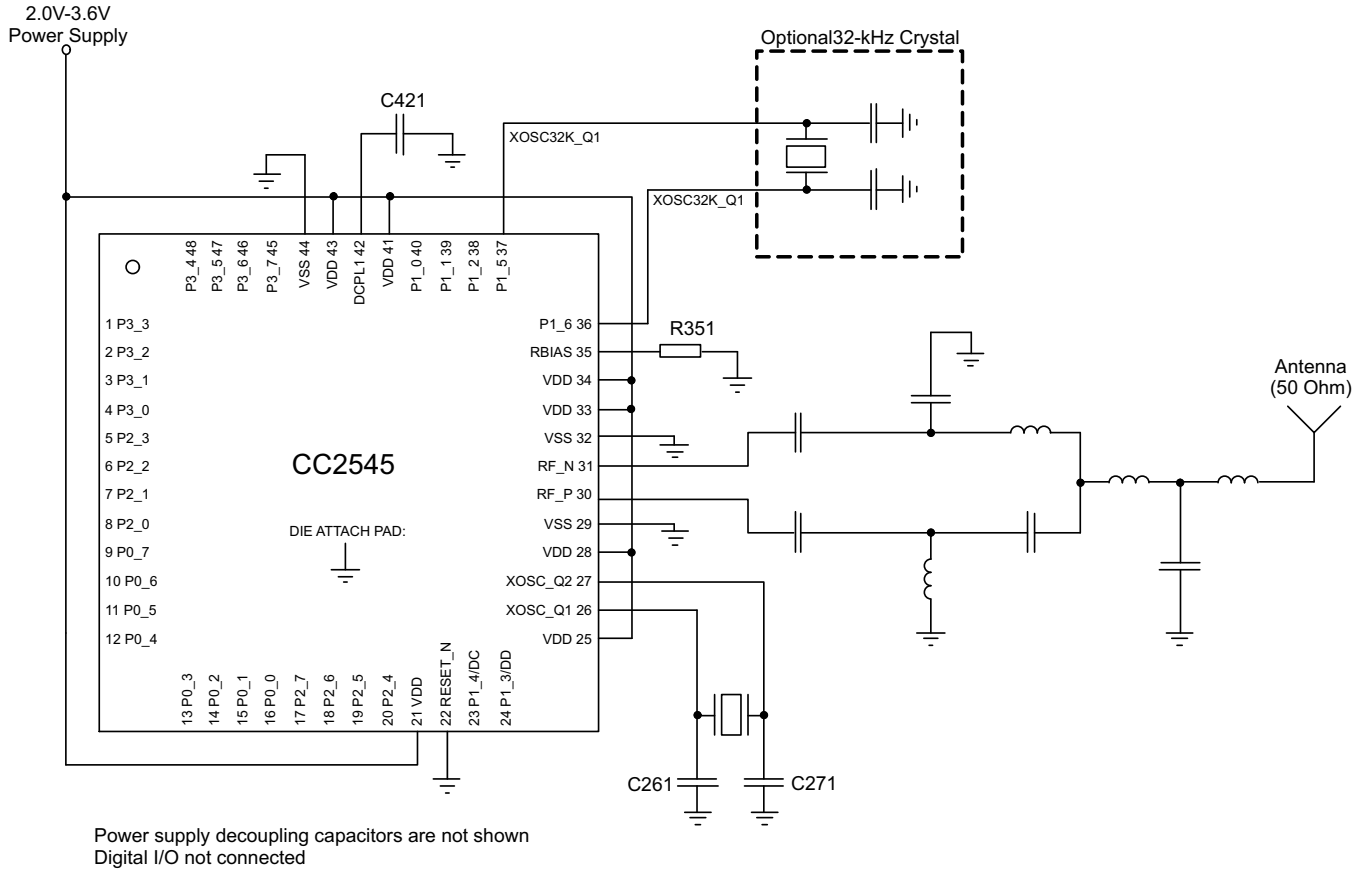

**Figure 19. CC2545 Application Circuit**

**Table 3. Overview of External Components (Excluding Balun, Crystal and Supply Decoupling Capacitors)**

Component	Description	Value
C421	Decoupling capacitor for the internal 1.8V digital voltage regulator	1 $\mu$ F
R351	Precision resistor $\pm$ 1%, used for internal biasing	56 k $\Omega$

**Input/Output Matching**

When using an unbalanced antenna such as a monopole, a balun should be used to optimize performance. The balun can be implemented using low-cost discrete inductors and capacitors. See reference design, CC2545EM, for recommended balun.

## Crystal

An external 32-MHz crystal with two loading capacitors is used for the 32-MHz crystal oscillator. The load capacitance seen by the 32-MHz crystal is given by:

$$C_L = \frac{1}{\frac{1}{C_{261}} + \frac{1}{C_{271}}} + C_{\text{parasitic}} \quad (1)$$

A series resistor may be used to comply with ESR requirement.

## On-Chip 1.8-V Voltage Regulator Decoupling

The 1.8-V on-chip voltage regulator supplies the 1.8-V digital logic. This regulator requires a decoupling capacitor (C421) for stable operation.

## Power-Supply Decoupling and Filtering

Proper power-supply decoupling must be used for optimum performance. The placement and size of the decoupling capacitors and the power supply filtering are very important to achieve the best performance in an application. TI provides a compact reference design that should be followed very closely.

## REVISION HISTORY

Changes from Original (June 2012) to Revision A	Page
• Deleted Product Preview banner .....	1
• Changed the Temperature coefficient Unit value From: mV/°C To: / 0.1°C .....	8
• Changed <a href="#">Figure 19</a> .....	22
Changes from Revision A (August 2012) to Revision B	Page
• Changed From: RTC Pin Package To: RGZ Pin Package .....	14

**PACKAGING INFORMATION**

Orderable Device	Status (1)	Package Type	Package Drawing	Pins	Package Qty	Eco Plan (2)	Lead/Ball Finish (6)	MSL Peak Temp (3)	Op Temp (°C)	Device Marking (4/5)	Samples
CC2545RGZR	ACTIVE	VQFN	RGZ	48	2500	Green (RoHS & no Sb/Br)	CU NIPDAU	Level-3-260C-168 HR	-40 to 85	CC2545	<a href="#">Samples</a>
CC2545RGZT	ACTIVE	VQFN	RGZ	48	250	Green (RoHS & no Sb/Br)	CU NIPDAU	Level-3-260C-168 HR	-40 to 85	CC2545	<a href="#">Samples</a>

(1) The marketing status values are defined as follows:

**ACTIVE:** Product device recommended for new designs.

**LIFEBUY:** TI has announced that the device will be discontinued, and a lifetime-buy period is in effect.

**NRND:** Not recommended for new designs. Device is in production to support existing customers, but TI does not recommend using this part in a new design.

**PREVIEW:** Device has been announced but is not in production. Samples may or may not be available.

**OBSOLETE:** TI has discontinued the production of the device.

(2) Eco Plan - The planned eco-friendly classification: Pb-Free (RoHS), Pb-Free (RoHS Exempt), or Green (RoHS & no Sb/Br) - please check <http://www.ti.com/productcontent> for the latest availability information and additional product content details.

**TBD:** The Pb-Free/Green conversion plan has not been defined.

**Pb-Free (RoHS):** TI's terms "Lead-Free" or "Pb-Free" mean semiconductor products that are compatible with the current RoHS requirements for all 6 substances, including the requirement that lead not exceed 0.1% by weight in homogeneous materials. Where designed to be soldered at high temperatures, TI Pb-Free products are suitable for use in specified lead-free processes.

**Pb-Free (RoHS Exempt):** This component has a RoHS exemption for either 1) lead-based flip-chip solder bumps used between the die and package, or 2) lead-based die adhesive used between the die and leadframe. The component is otherwise considered Pb-Free (RoHS compatible) as defined above.

**Green (RoHS & no Sb/Br):** TI defines "Green" to mean Pb-Free (RoHS compatible), and free of Bromine (Br) and Antimony (Sb) based flame retardants (Br or Sb do not exceed 0.1% by weight in homogeneous material)

(3) MSL, Peak Temp. - The Moisture Sensitivity Level rating according to the JEDEC industry standard classifications, and peak solder temperature.

(4) There may be additional marking, which relates to the logo, the lot trace code information, or the environmental category on the device.

(5) Multiple Device Markings will be inside parentheses. Only one Device Marking contained in parentheses and separated by a "~" will appear on a device. If a line is indented then it is a continuation of the previous line and the two combined represent the entire Device Marking for that device.

(6) Lead/Ball Finish - Orderable Devices may have multiple material finish options. Finish options are separated by a vertical ruled line. Lead/Ball Finish values may wrap to two lines if the finish value exceeds the maximum column width.

**Important Information and Disclaimer:** The information provided on this page represents TI's knowledge and belief as of the date that it is provided. TI bases its knowledge and belief on information provided by third parties, and makes no representation or warranty as to the accuracy of such information. Efforts are underway to better integrate information from third parties. TI has taken and continues to take reasonable steps to provide representative and accurate information but may not have conducted destructive testing or chemical analysis on incoming materials and chemicals. TI and TI suppliers consider certain information to be proprietary, and thus CAS numbers and other limited information may not be available for release.



In no event shall TI's liability arising out of such information exceed the total purchase price of the TI part(s) at issue in this document sold by TI to Customer on an annual basis.

RGZ (S-PVQFN-N48)

PLASTIC QUAD FLATPACK NO-LEAD

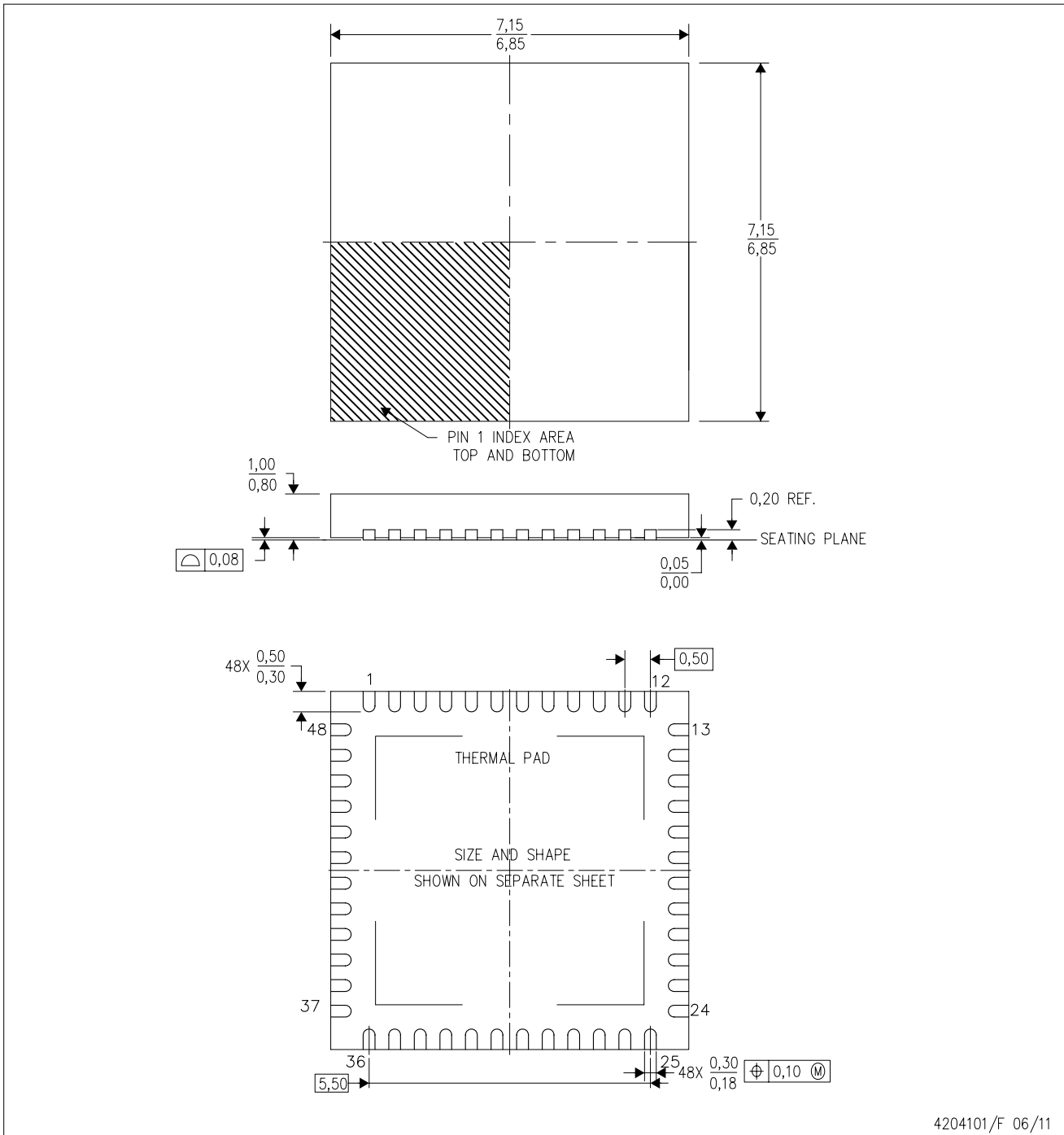

4204101/F 06/11

- NOTES:
- A. All linear dimensions are in millimeters. Dimensioning and tolerancing per ASME Y14.5M-1994.
  - B. This drawing is subject to change without notice.
  - C. Quad Flatpack, No-leads (QFN) package configuration.
  - D. The package thermal pad must be soldered to the board for thermal and mechanical performance.
  - E. See the additional figure in the Product Data Sheet for details regarding the exposed thermal pad features and dimensions.
  - F. Falls within JEDEC MO-220.

HERMAL INFORMATION

This package incorporates an exposed thermal pad that is designed to be attached directly to an external heatsink. The thermal pad must be soldered directly to the printed circuit board (PCB). After soldering, the PCB can be used as a heatsink. In addition, through the use of thermal vias, the thermal pad can be attached directly to the appropriate copper plane shown in the electrical schematic for the device, or alternatively, can be attached to a special heatsink structure designed into the PCB. This design optimizes the heat transfer from the integrated circuit (IC).

For information on the Quad Flatpack No-Lead (QFN) package and its advantages, refer to Application Report, QFN/SON PCB Attachment, Texas Instruments Literature No. SLUA271. This document is available at [www.ti.com](http://www.ti.com).

The exposed thermal pad dimensions for this package are shown in the following illustration.

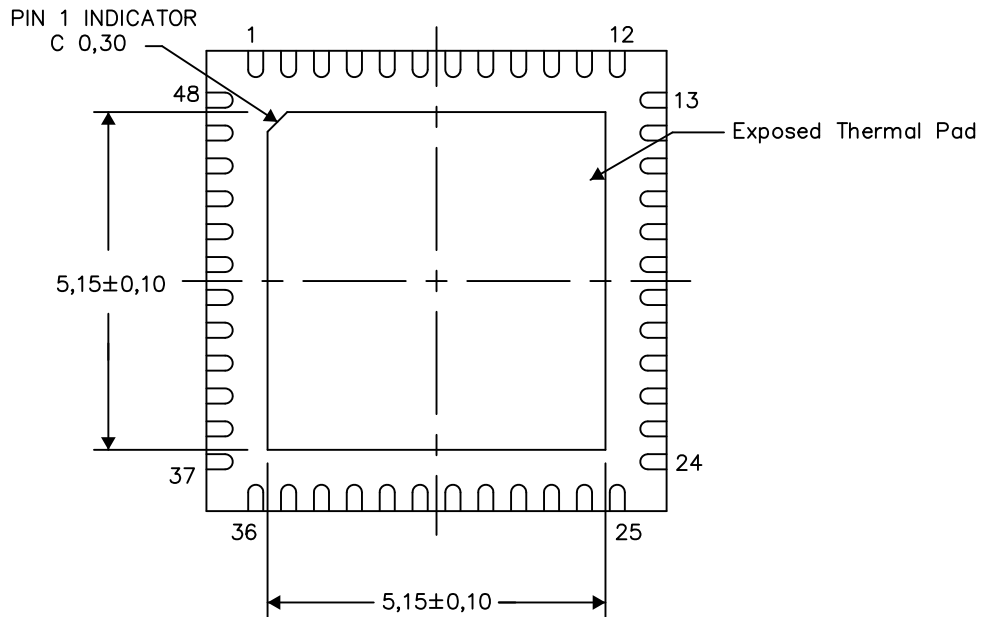

Bottom View

Exposed Thermal Pad Dimensions

4206354-2/Z 03/15

NOTE: All linear dimensions are in millimeters



## IMPORTANT NOTICE

Texas Instruments Incorporated (TI) reserves the right to make corrections, enhancements, improvements and other changes to its semiconductor products and services per JESD46, latest issue, and to discontinue any product or service per JESD48, latest issue. Buyers should obtain the latest relevant information before placing orders and should verify that such information is current and complete.

TI's published terms of sale for semiconductor products (<http://www.ti.com/sc/docs/stdterms.htm>) apply to the sale of packaged integrated circuit products that TI has qualified and released to market. Additional terms may apply to the use or sale of other types of TI products and services.

Reproduction of significant portions of TI information in TI data sheets is permissible only if reproduction is without alteration and is accompanied by all associated warranties, conditions, limitations, and notices. TI is not responsible or liable for such reproduced documentation. Information of third parties may be subject to additional restrictions. Resale of TI products or services with statements different from or beyond the parameters stated by TI for that product or service voids all express and any implied warranties for the associated TI product or service and is an unfair and deceptive business practice. TI is not responsible or liable for any such statements.

Buyers and others who are developing systems that incorporate TI products (collectively, "Designers") understand and agree that Designers remain responsible for using their independent analysis, evaluation and judgment in designing their applications and that Designers have full and exclusive responsibility to assure the safety of Designers' applications and compliance of their applications (and of all TI products used in or for Designers' applications) with all applicable regulations, laws and other applicable requirements. Designer represents that, with respect to their applications, Designer has all the necessary expertise to create and implement safeguards that (1) anticipate dangerous consequences of failures, (2) monitor failures and their consequences, and (3) lessen the likelihood of failures that might cause harm and take appropriate actions. Designer agrees that prior to using or distributing any applications that include TI products, Designer will thoroughly test such applications and the functionality of such TI products as used in such applications.

TI's provision of technical, application or other design advice, quality characterization, reliability data or other services or information, including, but not limited to, reference designs and materials relating to evaluation modules, (collectively, "TI Resources") are intended to assist designers who are developing applications that incorporate TI products; by downloading, accessing or using TI Resources in any way, Designer (individually or, if Designer is acting on behalf of a company, Designer's company) agrees to use any particular TI Resource solely for this purpose and subject to the terms of this Notice.

TI's provision of TI Resources does not expand or otherwise alter TI's applicable published warranties or warranty disclaimers for TI products, and no additional obligations or liabilities arise from TI providing such TI Resources. TI reserves the right to make corrections, enhancements, improvements and other changes to its TI Resources. TI has not conducted any testing other than that specifically described in the published documentation for a particular TI Resource.

Designer is authorized to use, copy and modify any individual TI Resource only in connection with the development of applications that include the TI product(s) identified in such TI Resource. NO OTHER LICENSE, EXPRESS OR IMPLIED, BY ESTOPPEL OR OTHERWISE TO ANY OTHER TI INTELLECTUAL PROPERTY RIGHT, AND NO LICENSE TO ANY TECHNOLOGY OR INTELLECTUAL PROPERTY RIGHT OF TI OR ANY THIRD PARTY IS GRANTED HEREIN, including but not limited to any patent right, copyright, mask work right, or other intellectual property right relating to any combination, machine, or process in which TI products or services are used. Information regarding or referencing third-party products or services does not constitute a license to use such products or services, or a warranty or endorsement thereof. Use of TI Resources may require a license from a third party under the patents or other intellectual property of the third party, or a license from TI under the patents or other intellectual property of TI.

TI RESOURCES ARE PROVIDED "AS IS" AND WITH ALL FAULTS. TI DISCLAIMS ALL OTHER WARRANTIES OR REPRESENTATIONS, EXPRESS OR IMPLIED, REGARDING RESOURCES OR USE THEREOF, INCLUDING BUT NOT LIMITED TO ACCURACY OR COMPLETENESS, TITLE, ANY EPIDEMIC FAILURE WARRANTY AND ANY IMPLIED WARRANTIES OF MERCHANTABILITY, FITNESS FOR A PARTICULAR PURPOSE, AND NON-INFRINGEMENT OF ANY THIRD PARTY INTELLECTUAL PROPERTY RIGHTS. TI SHALL NOT BE LIABLE FOR AND SHALL NOT DEFEND OR INDEMNIFY DESIGNER AGAINST ANY CLAIM, INCLUDING BUT NOT LIMITED TO ANY INFRINGEMENT CLAIM THAT RELATES TO OR IS BASED ON ANY COMBINATION OF PRODUCTS EVEN IF DESCRIBED IN TI RESOURCES OR OTHERWISE. IN NO EVENT SHALL TI BE LIABLE FOR ANY ACTUAL, DIRECT, SPECIAL, COLLATERAL, INDIRECT, PUNITIVE, INCIDENTAL, CONSEQUENTIAL OR EXEMPLARY DAMAGES IN CONNECTION WITH OR ARISING OUT OF TI RESOURCES OR USE THEREOF, AND REGARDLESS OF WHETHER TI HAS BEEN ADVISED OF THE POSSIBILITY OF SUCH DAMAGES.

Unless TI has explicitly designated an individual product as meeting the requirements of a particular industry standard (e.g., ISO/TS 16949 and ISO 26262), TI is not responsible for any failure to meet such industry standard requirements.

Where TI specifically promotes products as facilitating functional safety or as compliant with industry functional safety standards, such products are intended to help enable customers to design and create their own applications that meet applicable functional safety standards and requirements. Using products in an application does not by itself establish any safety features in the application. Designers must ensure compliance with safety-related requirements and standards applicable to their applications. Designer may not use any TI products in life-critical medical equipment unless authorized officers of the parties have executed a special contract specifically governing such use. Life-critical medical equipment is medical equipment where failure of such equipment would cause serious bodily injury or death (e.g., life support, pacemakers, defibrillators, heart pumps, neurostimulators, and implantables). Such equipment includes, without limitation, all medical devices identified by the U.S. Food and Drug Administration as Class III devices and equivalent classifications outside the U.S.

TI may expressly designate certain products as completing a particular qualification (e.g., Q100, Military Grade, or Enhanced Product). Designers agree that it has the necessary expertise to select the product with the appropriate qualification designation for their applications and that proper product selection is at Designers' own risk. Designers are solely responsible for compliance with all legal and regulatory requirements in connection with such selection.

Designer will fully indemnify TI and its representatives against any damages, costs, losses, and/or liabilities arising out of Designer's non-compliance with the terms and provisions of this Notice.