

CDC2509C

3.3-V PHASE-LOCK LOOP CLOCK DRIVER

SCAS620A – DECEMBER 1998 – REVISED DECEMBER 2004

- Use **CDCVF2509A** as a Replacement for this Device
- Designed to Meet PC SDRAM Registered DIMM Design Support Document Rev. 1.2
- Spread Spectrum Clock Compatible
- Operating Frequency 25 MHz to 125 MHz
- Static tPhase Error Distribution at 66MHz to 100 MHz is ± 150 ps
- Drop-In Replacement for TI CDC2509A With Enhanced Performance
- Jitter (cyc – cyc) at 66 MHz to 100 MHz is |100 ps|
- Available in Plastic 24-Pin TSSOP
- Phase-Lock Loop Clock Distribution for Synchronous DRAM Applications
- Distributes One Clock Input to One Bank of Five and One Bank of Four Outputs
- Separate Output Enable for Each Output Bank
- External Feedback (FBIN) Terminal Is Used to Synchronize the Outputs to the Clock Input
- On-Chip Series Damping Resistors
- No External RC Network Required
- Operates at 3.3 V

**PW PACKAGE
(TOP VIEW)**



description

The CDC2509C is a high-performance, low-skew, low-jitter, phase-lock loop (PLL) clock driver. It uses a PLL to precisely align, in both frequency and phase, the feedback (FBOUT) output to the clock (CLK) input signal. It is specifically designed for use with synchronous DRAMs. The CDC2509C operates at 3.3 V V_{CC}. It also provides integrated series-damping resistors that make it ideal for driving point-to-point loads.

One bank of five outputs and one bank of four outputs provide nine low-skew, low-jitter copies of CLK. Output signal duty cycles are adjusted to 50%, independent of the duty cycle at CLK. Each bank of outputs is enabled or disabled separately via the control (1G and 2G) inputs. When the G inputs are high, the outputs switch in phase and frequency with CLK; when the G inputs are low, the outputs are disabled to the logic-low state.

Unlike many products containing PLLs, the CDC2509C does not require external RC networks. The loop filter for the PLL is included on-chip, minimizing component count, board space, and cost.

Because it is based on PLL circuitry, the CDC2509C requires a stabilization time to achieve phase lock of the feedback signal to the reference signal. This stabilization time is required, following power up and application of a fixed-frequency, fixed-phase signal at CLK, and following any changes to the PLL reference or feedback signals. The PLL can be bypassed for test purposes by strapping AV_{CC} to ground.

The CDC2509C is characterized for operation from 0°C to 85°C.



Please be aware that an important notice concerning availability, standard warranty, and use in critical applications of Texas Instruments semiconductor products and disclaimers thereto appears at the end of this data sheet.

PRODUCTION DATA information is current as of publication date. Products conform to specifications per the terms of Texas Instruments standard warranty. Production processing does not necessarily include testing of all parameters.

**TEXAS
INSTRUMENTS**

POST OFFICE BOX 655303 • DALLAS, TEXAS 75265

Copyright © 1998 – 2004, Texas Instruments Incorporated

CDC2509C

3.3-V PHASE-LOCK LOOP CLOCK DRIVER

SCAS620A – DECEMBER 1998 – REVISED DECEMBER 2004

description (continued)

For application information refer to application reports *High Speed Distribution Design Techniques for CDC509/516/2509/2510/2516* (literature number SLMA003) and *Using CDC2509A/2510A PLL with Spread Spectrum Clocking (SSC)* (literature number SCAA039).

FUNCTION TABLE

INPUTS			OUTPUTS		
1G	2G	CLK	1Y (0:4)	2Y (0:3)	FBOU
X	X	L	L	L	L
L	L	H	L	L	H
L	H	H	L	H	H
H	L	H	H	L	H
H	H	H	H	H	H

functional block diagram

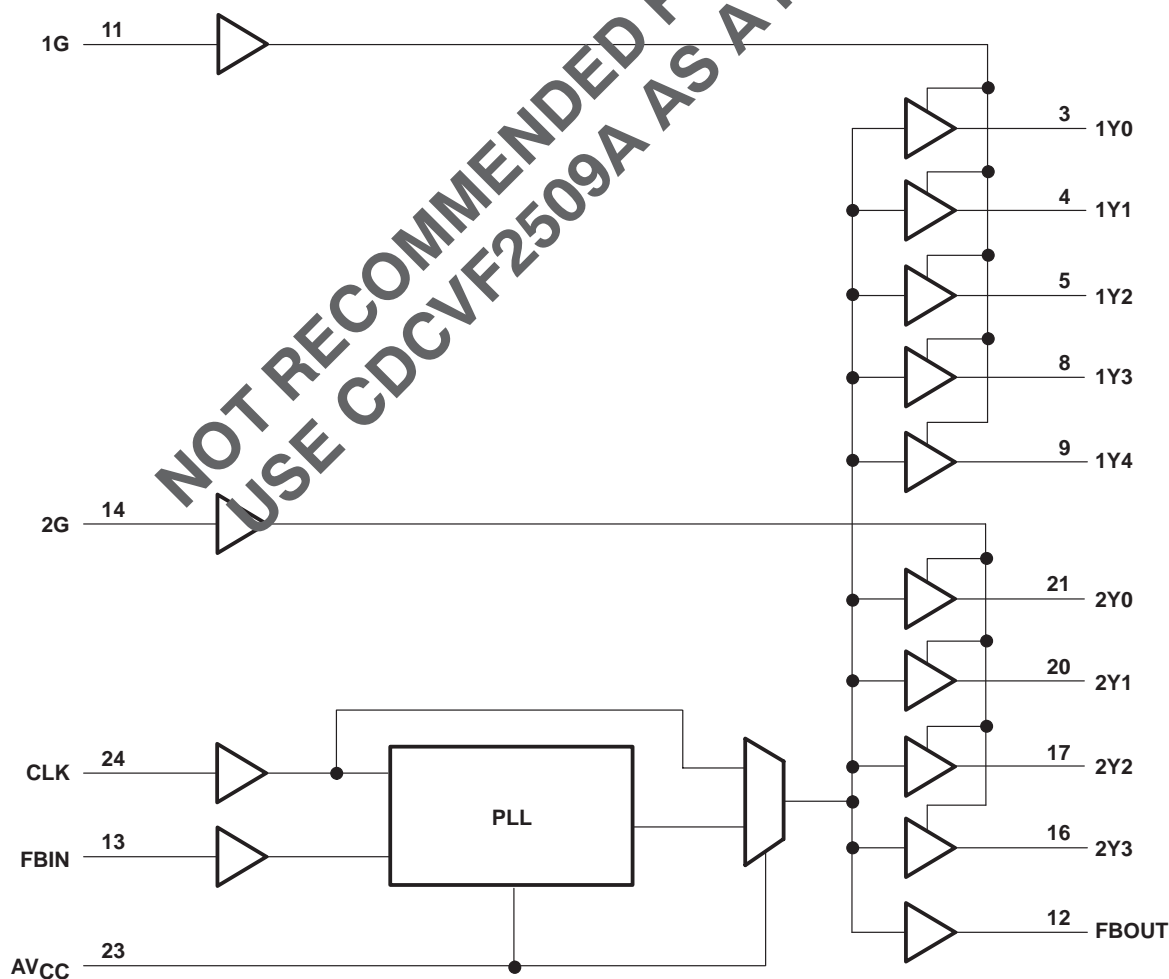

AVAILABLE OPTIONS



POST OFFICE BOX 655303 • DALLAS, TEXAS 75265

CDC2509C

3.3-V PHASE-LOCK LOOP CLOCK DRIVER

SCAS620A – DECEMBER 1998 – REVISED DECEMBER 2004

T_A	PACKAGE
	SMALL OUTLINE (PW)
0°C to 85°C	CDC2509CPWR

Terminal Functions

TERMINAL		TYPE	DESCRIPTION
NAME	NO.		
CLK	24	I	Clock input. CLK provides the clock signal to be distributed by the CDC2509C clock driver. CLK is used to provide the reference signal to the integrated PLL that generates the clock output signals. CLK must have a fixed frequency and fixed phase for the PLL to obtain phase lock. Once the circuit is powered up and a valid CLK signal is applied, a stabilization time is required for the PLL to phase lock the feedback signal to its reference signal.
FBIN	13	I	Feedback input. FBIN provides the feedback signal to the internal PLL. FBIN must be hard-wired to FBOUT to complete the PLL. The integrated PLL synchronizes CLK and FBIN so that there is nominally zero phase error between CLK and FBIN.
1G	11	I	Output bank enable. 1G is the output enable for outputs 1Y(0:4). When 1G is low, outputs 1Y(0:4) are disabled to a logic-low state. When 1G is high, all outputs 1Y(0:4) are enabled and switch at the same frequency as CLK.
2G	14	I	Output bank enable. 2G is the output enable for outputs 2Y(0:3). When 2G is low, outputs 2Y(0:3) are disabled to a logic-low state. When 2G is high, all outputs 2Y(0:3) are enabled and switch at the same frequency as CLK.
FBOUT	12	O	Feedback output. FBOUT is dedicated for external feedback. It switches at the same frequency as CLK. When externally wired to FBIN, FBOUT completes the feedback loop of the PLL. FBOUT has an integrated 25- Ω series-damping resistor.
1Y (0:4)	3, 4, 5, 8, 9	O	Clock outputs. These outputs provide low-skew copies of CLK. Output bank 1Y(0:4) is enabled via the 1G input. These outputs can be disabled to a logic-low state by deasserting the 1G control input. Each output has an integrated 25- Ω series-damping resistor.
2Y (0:3)	21, 20, 17, 16	O	Clock outputs. These outputs provide low-skew copies of CLK. Output bank 2Y(0:3) is enabled via the 2G input. These outputs can be disabled to a logic-low state by deasserting the 2G control input. Each output has an integrated 25- Ω series-damping resistor.
AV _{CC}	23	Power	Analog power supply. AV _{CC} provides the power reference for the analog circuitry. In addition, AV _{CC} can be used to bypass the PLL for test purposes. When AV _{CC} is strapped to ground, PLL is bypassed and CLK is buffered directly to the device outputs.
AGND	1	Ground	Analog ground. AGND provides the ground reference for the analog circuitry.
V _{CC}	2, 10, 15, 22	Power	Power supply
GND	6, 7, 18, 19	Ground	Ground



CDC2509C

3.3-V PHASE-LOCK LOOP CLOCK DRIVER

SCAS620A – DECEMBER 1998 – REVISED DECEMBER 2004

absolute maximum ratings over operating free-air temperature range (unless otherwise noted)†

Supply voltage range, AV_{CC} (see Note 1)	$AV_{CC} < V_{CC} + 0.7$ V
Supply voltage range, V_{CC}	-0.5 V to 4.6 V
Input voltage range, V_I (see Note 2)	-0.5 V to 6.5 V
Voltage range applied to any output in the high or low state, V_O (see Notes 2 and 3)	-0.5 V to $V_{CC} + 0.5$ V
Input clamp current, I_{IK} ($V_I < 0$)	-50 mA
Output clamp current, I_{OK} ($V_O < 0$ or $V_O > V_{CC}$)	±50 mA
Continuous output current, I_O ($V_O = 0$ to V_{CC})	±50 mA
Continuous current through each V_{CC} or GND	±100 mA
Maximum power dissipation at $T_A = 55^\circ\text{C}$ (in still air) (see Note 4)	0.7 W
Storage temperature range, T_{stg}	-65°C to 150°C

† Stresses beyond those listed under “absolute maximum ratings” may cause permanent damage to the device. These are stress ratings only, and functional operation of the device at these or any other conditions beyond those indicated under “recommended operating conditions” is not implied. Exposure to absolute-maximum-rated conditions for extended periods may affect device reliability.

NOTES: 1. AV_{CC} **must not** exceed V_{CC} .

2. The input and output negative-voltage ratings may be exceeded if the input and output clamp-current ratings are observed.

3. This value is limited to 4.6 V maximum.

4. The maximum package power dissipation is calculated using a junction temperature of 150°C and a board trace length of 750 mils. For more information, refer to the *Package Thermal Considerations* application note in the *ABT Advanced BiCMOS Technology Data Book*, literature number SCBD002.

recommended operating conditions (see Note 5)

	MIN	MAX	UNIT
V_{CC}, AV_{CC} Supply voltage	3	3.6	V
V_{IH} High-level input voltage	2		V
V_{IL} Low-level input voltage		0.8	V
V_I Input voltage	0	V_{CC}	V
I_{OH} High-level output current		-12	mA
I_{OL} Low-level output current		12	mA
T_A Operating free-air temperature	0	85	°C

NOTE 5: Unused inputs must be held high or low to prevent them from floating.

timing requirements over recommended ranges of supply voltage and operating free-air temperature

	MIN	MAX	UNIT
f_{clk} Clock frequency	25	125	MHz
Input clock duty cycle	40%	60%	
Stabilization time†		1	ms

† Time required for the integrated PLL circuit to obtain phase lock of its feedback signal to its reference signal. For phase lock to be obtained, a fixed-frequency, fixed-phase reference signal must be present at CLK. Until phase lock is obtained, the specifications for propagation delay, skew, and jitter parameters given in the switching characteristics table are not applicable. This parameter does not apply for input modulation under SSC application.



CDC2509C

3.3-V PHASE-LOCK LOOP CLOCK DRIVER

SCAS620A – DECEMBER 1998 – REVISED DECEMBER 2004

electrical characteristics over recommended operating free-air temperature range (unless otherwise noted)

PARAMETER		TEST CONDITIONS	V _{CC} , AV _{CC}	MIN	TYP [‡]	MAX	UNIT
V _{IK}	Input clamp voltage	I _I = -18 mA	3 V			-1.2	V
V _{OH}	High-level output voltage	I _{OH} = -100 μA	MIN to MAX	V _{CC} -0.2			V
		I _{OH} = -12 mA	3 V		2.1		
		I _{OH} = -6 mA	3 V		2.4		
V _{OL}	Low-level output voltage	I _{OL} = 100 μA	MIN to MAX			0.2	V
		I _{OL} = 12 mA	3 V			0.8	
		I _{OL} = 6 mA	3 V			0.55	
I _{OH}	High-level output current	V _O = 1 V	3.135 V			-32	mA
		V _O = 1.65 V	3.3 V			-36	
		V _O = 3.135 V	3.465 V			-12	
I _{OL}	Low-level output current	V _O = 1.95 V	3.135 V	34			mA
		V _O = 1.65 V	3.3 V		40		
		V _O = 0.4 V	3.465 V			14	
I _I	Input current	V _I = V _{CC} or GND	3.6 V			±5	μA
I _{CC} [§]	Supply current	V _I = V _{CC} or GND, V _O = 0, Outputs: low or high	3.6 V			10	μA
ΔI _{CC}	Change in supply current	One input at V _{CC} = 0.6 V, Other inputs = V _{CC} or GND	3.3 V to 3.6 V			500	μA
C _i	Input capacitance	V _I = V _{CC} or GND	3.3 V			4	pF
C _o	Output capacitance	V _O = V _{CC} or GND	3.3 V			6	pF

[‡] For conditions shown as MIN or MAX, use the appropriate value specified under recommended operating conditions.

[§] For I_{CC} of AV_{CC}, and I_{CC} vs Frequency (see Figures 11 and 12).

switching characteristics over recommended ranges of supply voltage and operating free-air temperature, C_L = 30 pF (see Note 6 and Figures 1 and 2)[‡]

PARAMETER	FROM (INPUT)/CONDITION	TO (OUTPUT)	V _{CC} , AV _{CC} = 3.3 V ± 0.165 V			UNIT
			MIN	TYP	MAX	
Phase error time – static (normalized) (See Figures 3 – 5)	CLKIN↑ = 66 MHz to 100 MHz	FBIN↑	-150		150	ps
t _{sk(o)} Output skew time [§]	Any Y or FBOUT	Any Y or FBOUT			200	ps
Phase error time – jitter (see Note 7)	Clkin = 66 MHz to 100 MHz	Any Y or FBOUT	-50		50	ps
Jitter _(cycle-cycle) (See Figures 9 and 10)		Any Y or FBOUT			100	
Duty cycle	F(clkin > 60 MHz)	Any Y or FBOUT	45%		55%	
t _r Rise time (See Notes 8 and 9)	V _O = 1.2 V to 1.8 V, IBIS simulation	Any Y or FBOUT	2.5		1	V/ns
t _f Fall time (See Notes 8 and 9)	V _O = 1.2 V to 1.8 V, IBIS simulation	Any Y or FBOUT	2.5		1	V/ns

[‡] These parameters are not production tested.

[§] The t_{sk(o)} specification is only valid for equal loading of all outputs.

NOTES: 6. The specifications for parameters in this table are applicable only after any appropriate stabilization time has elapsed.

7. Calculated per PC DRAM SPEC (t_{phase error, static – jitter_(cycle-to-cycle)}).

8. This is equivalent to 0.8 ns/2.5 ns and 0.8 ns/2.7 ns into standard 500 Ω/ 30 pF load for output swing of 0.4 V to 2 V.

9. 64 MB DIMM configuration according to PC SDRAM Registered DIMM Design Support Document, Figure 20 and Table 13.

Intel is a trademark of Intel Corporation.

PC SDRAM Register DIMM Design Support Document is published by Intel Corporation.



CDC2509C
3.3-V PHASE-LOCK LOOP CLOCK DRIVER

SCAS620A – DECEMBER 1998 – REVISED DECEMBER 2004

PARAMETER MEASUREMENT INFORMATION

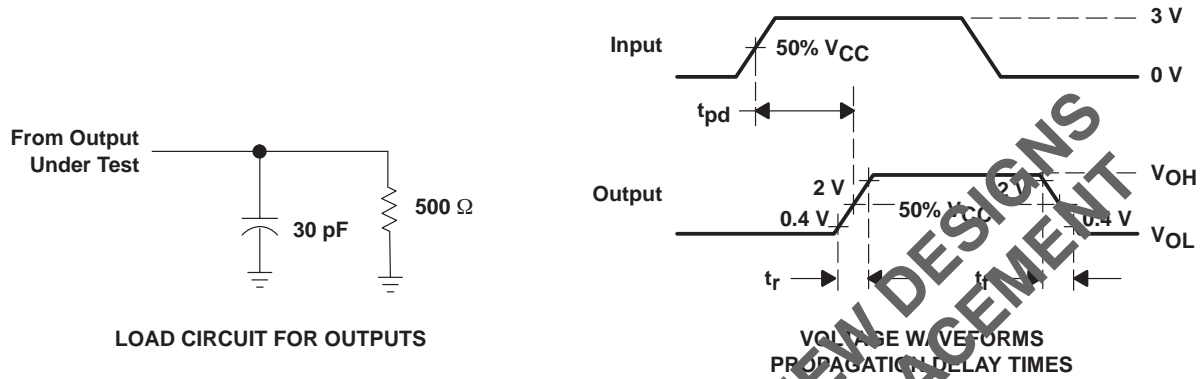

- NOTES: A. C_L includes probe and jig capacitance.
 B. All input pulses are supplied by generators having the following characteristics: PRR ≤ 100 MHz, Z_O = 50 Ω, t_r ≤ 1.2 ns, t_f ≤ 1.2 ns.
 C. The outputs are measured one at a time with one transition per measurement.

Figure 1. Load Circuit and Voltage Waveforms

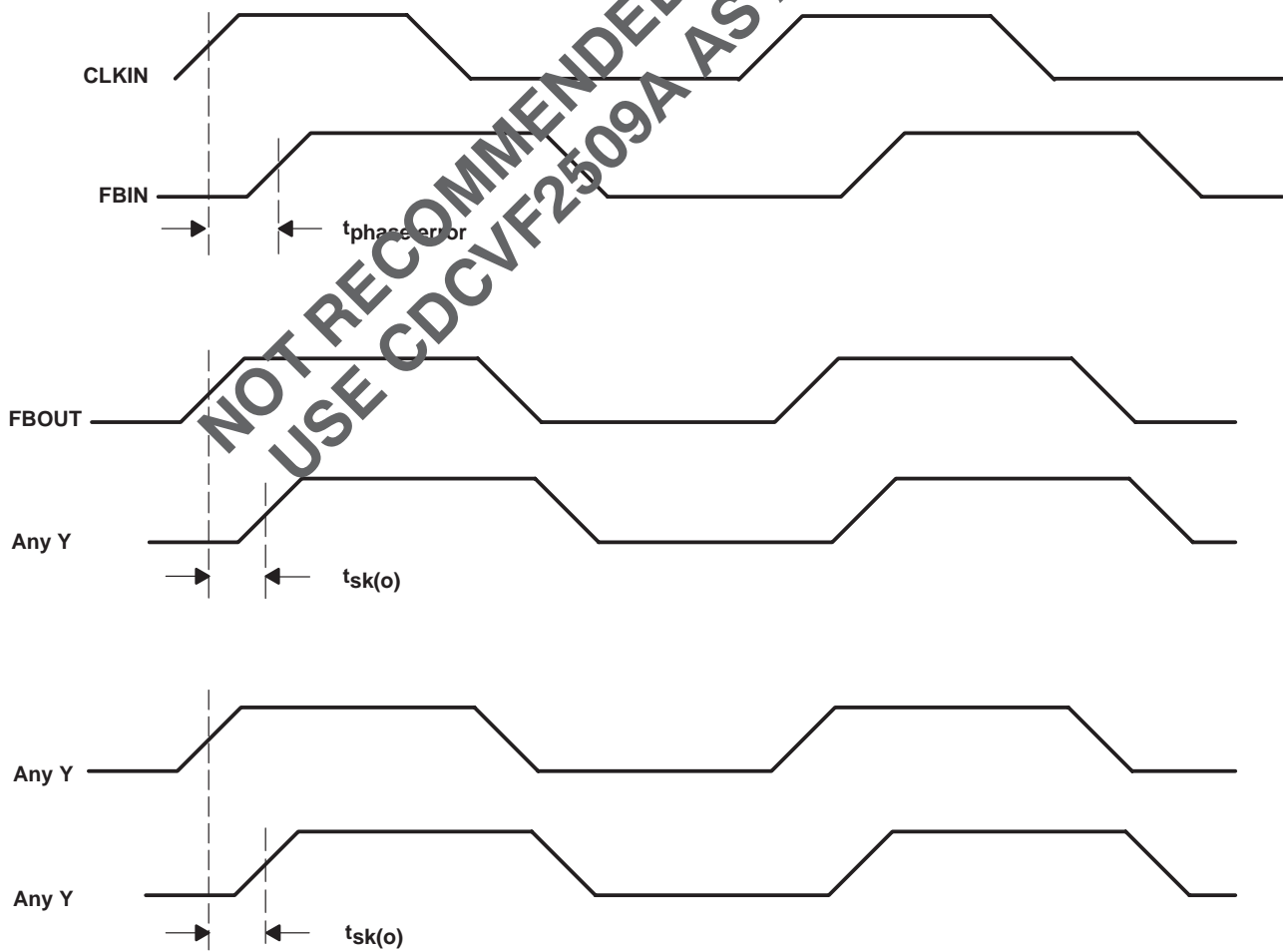

Figure 2. Phase Error and Skew Calculations

TYPICAL CHARACTERISTICS

CDC2509C
PHASE ADJUSTMENT SLOPE AND PHASE ERROR
vs
LOAD CAPACITANCE

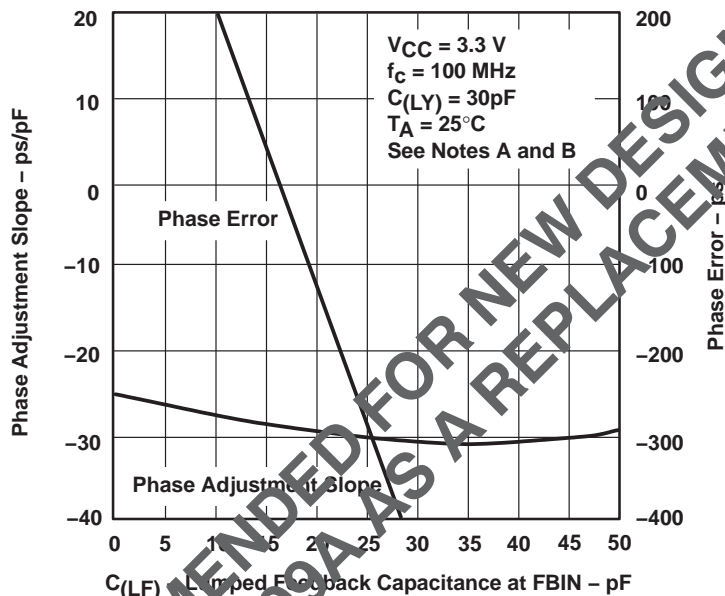

Figure 3
CDC2509A
PHASE ADJUSTMENT SLOPE AND PHASE ERROR
vs
LOAD CAPACITANCE

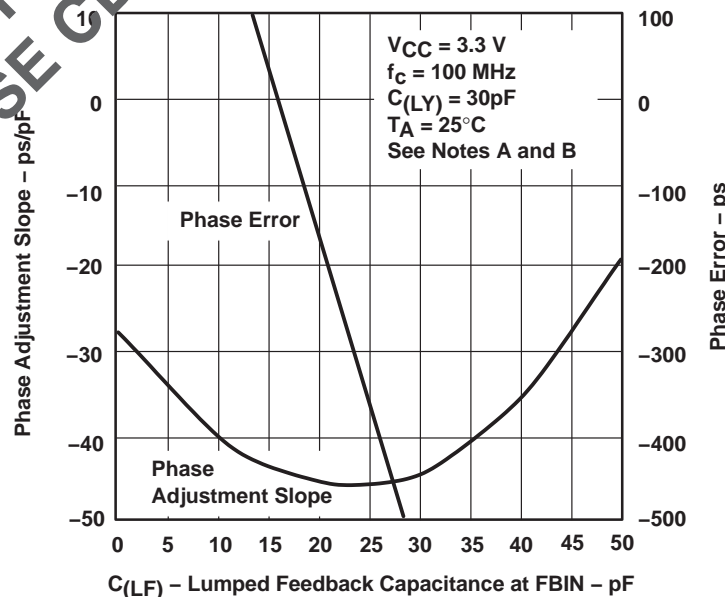

Figure 4

NOTES: A. Trace feedback length FBOUT to FBIN = 5 mm, $Z_0 = 50\ \Omega$ Phase error measured from CLK to Y
B. CLF = Lumped feedback capacitance at FBIN

CDC2509C

3.3-V PHASE-LOCK LOOP CLOCK DRIVER

SCAS620A – DECEMBER 1998 – REVISED DECEMBER 2004

TYPICAL CHARACTERISTICS

PHASE ERROR
vs
CLOCK FREQUENCY

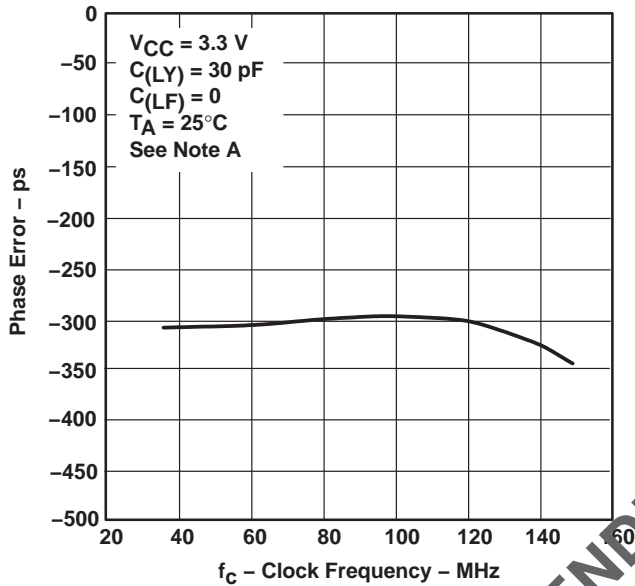

Figure 5

PHASE ERROR
vs
SUPPLY VOLTAGE

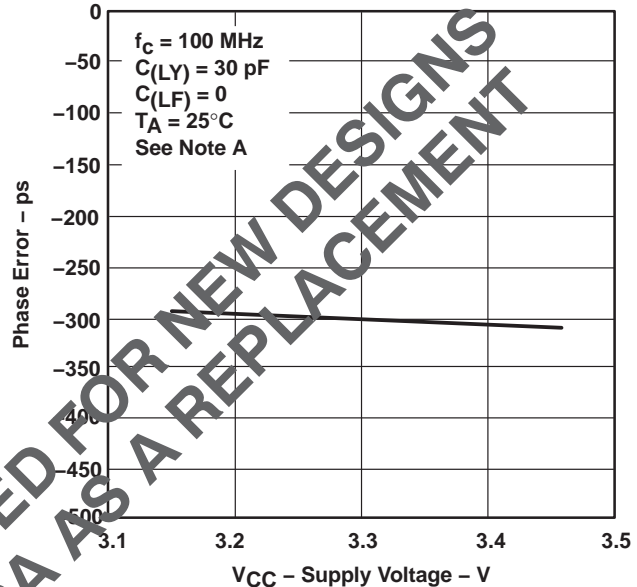

Figure 6

CDC2509C
STATIC PHASE ERROR
vs
CLOCK FREQUENCY

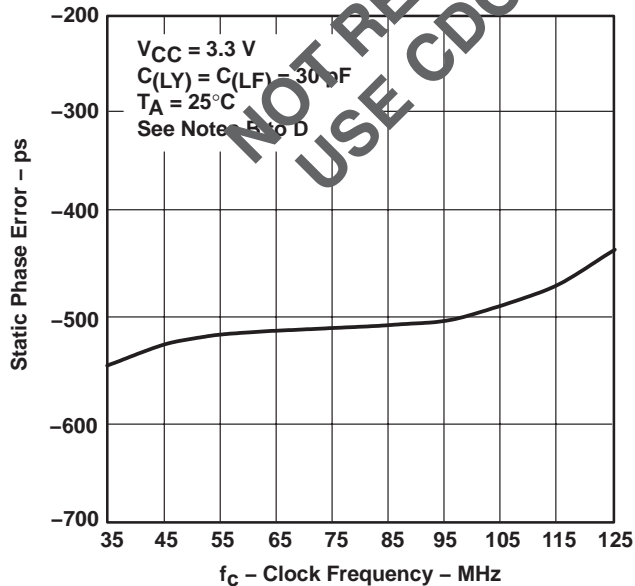

Figure 7

CDC2509A
STATIC PHASE ERROR
vs
CLOCK FREQUENCY

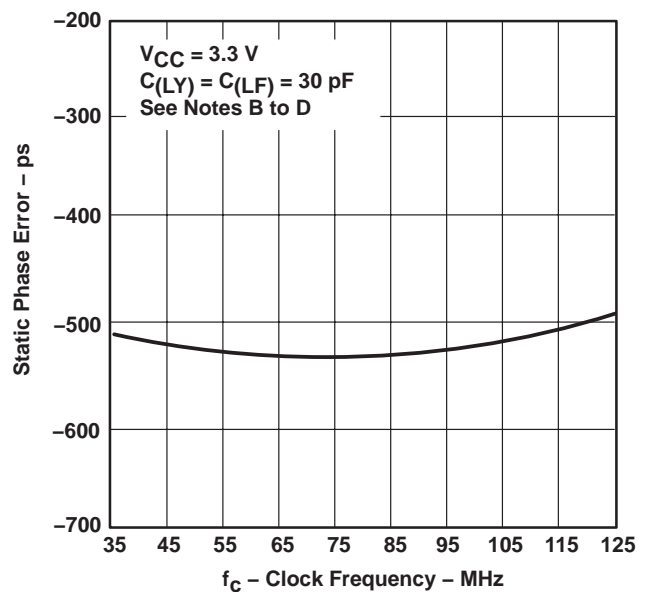
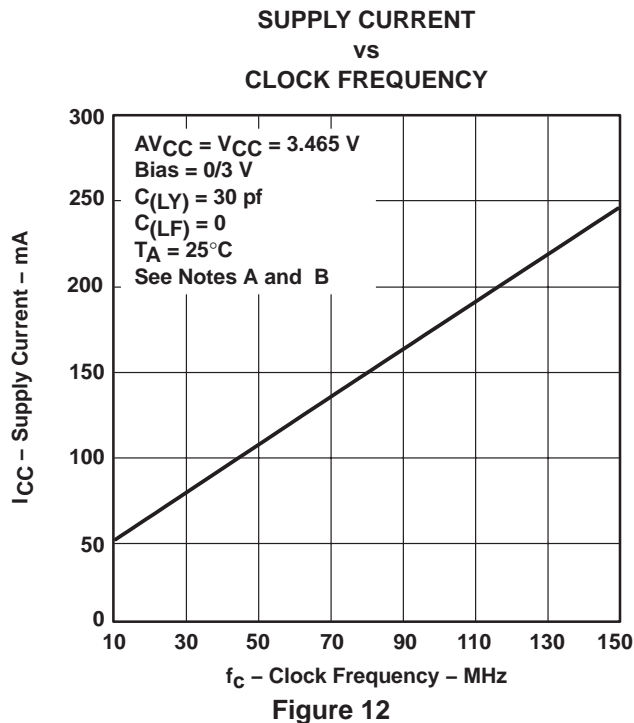
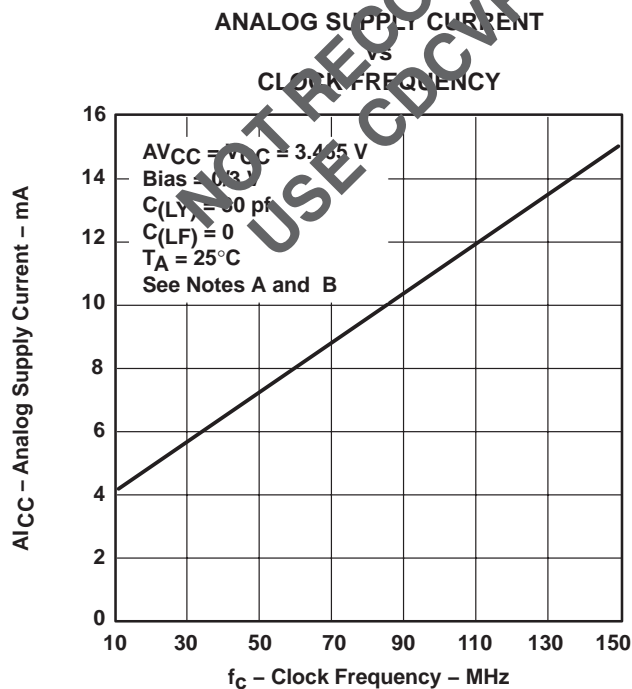
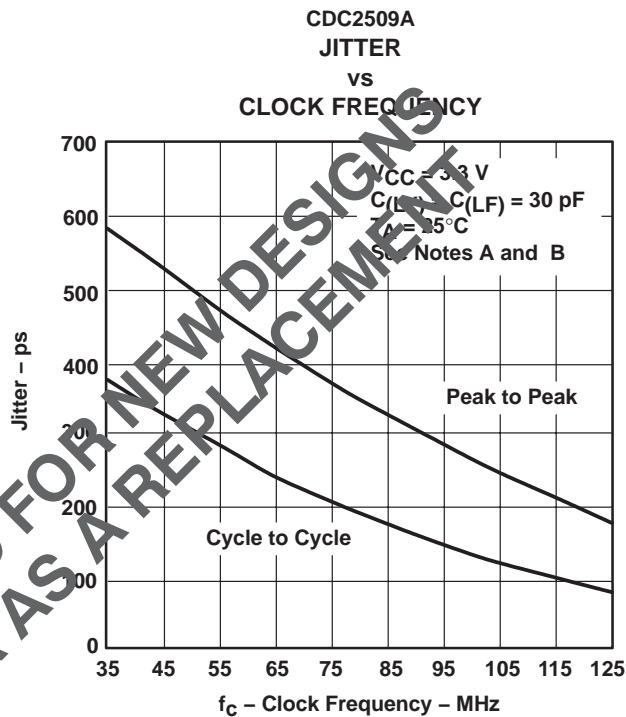
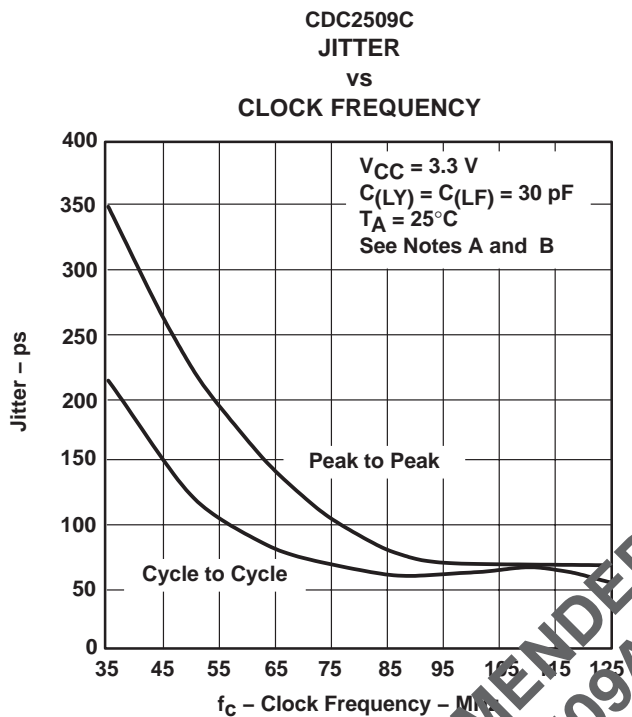

Figure 8

- NOTES: A. Trace feedback length FBOUT to FBIN = 5 mm, $Z_0 = 50\ \Omega$
 B. Phase error measured from CLK to FBIN
 C. CLY = Lumped capacitive load at Y
 D. CLF = Lumped feedback capacitance at FBIN

TYPICAL CHARACTERISTICS



NOTES: A. $C_{(LY)}$ = Lumped capacitive load at Y
B. $C_{(LF)}$ = Lumped feedback capacitance at FBIN

CDC2509C
3.3-V PHASE-LOCK LOOP CLOCK DRIVER

SCAS620A – DECEMBER 1998 – REVISED DECEMBER 2004

TYPICAL CHARACTERISTICS

**TI SILICON-BASED
 PLL PULLDOWN IBIS I/V**

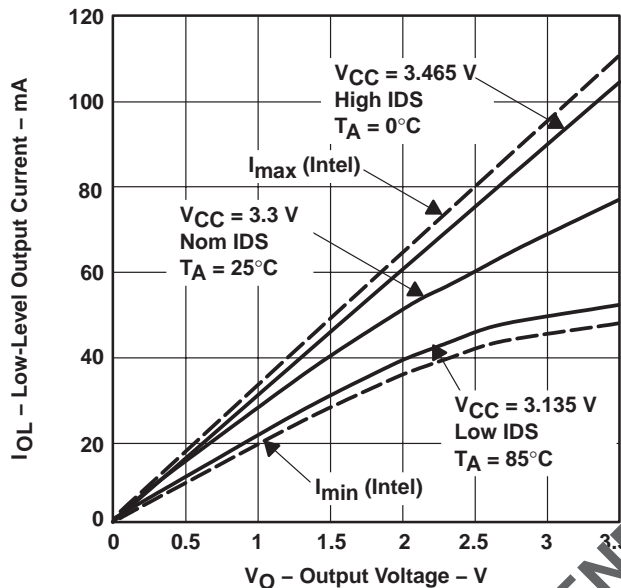

Figure 13

**TI SILICON-BASED
 PLL PULLUP IBIS I/V**

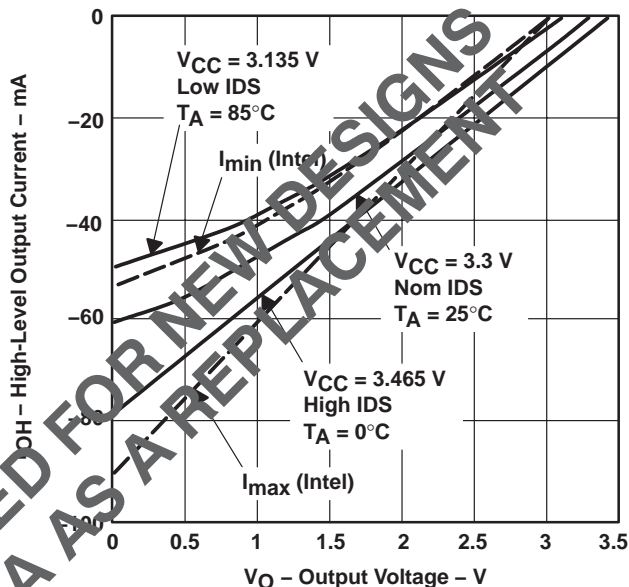

Figure 14

NOT RECOMMENDED FOR NEW DESIGNS
 USE CDCVF2509A AS A REPLACEMENT

PACKAGING INFORMATION

Orderable Device	Status (1)	Package Type	Package Drawing	Pins	Package Qty	Eco Plan (2)	Lead/Ball Finish	MSL Peak Temp (3)	Op Temp (°C)	Top-Side Markings (4)	Samples
CDC2509CPW	NRND	TSSOP	PW	24	60	Green (RoHS & no Sb/Br)	CU NIPDAU	Level-1-260C-UNLIM		CK2509C	
CDC2509CPWG4	NRND	TSSOP	PW	24	60	Green (RoHS & no Sb/Br)	CU NIPDAU	Level-1-260C-UNLIM		CK2509C	
CDC2509CPWR	NRND	TSSOP	PW	24	2000	Green (RoHS & no Sb/Br)	CU NIPDAU	Level-1-260C-UNLIM		CK2509C	
CDC2509CPWRG4	NRND	TSSOP	PW	24	2000	Green (RoHS & no Sb/Br)	CU NIPDAU	Level-1-260C-UNLIM		CK2509C	

(1) The marketing status values are defined as follows:

ACTIVE: Product device recommended for new designs.

LIFEBUY: TI has announced that the device will be discontinued, and a lifetime-buy period is in effect.

NRND: Not recommended for new designs. Device is in production to support existing customers, but TI does not recommend using this part in a new design.

PREVIEW: Device has been announced but is not in production. Samples may or may not be available.

OBSOLETE: TI has discontinued the production of the device.

(2) Eco Plan - The planned eco-friendly classification: Pb-Free (RoHS), Pb-Free (RoHS Exempt), or Green (RoHS & no Sb/Br) - please check <http://www.ti.com/productcontent> for the latest availability information and additional product content details.

TBD: The Pb-Free/Green conversion plan has not been defined.

Pb-Free (RoHS): TI's terms "Lead-Free" or "Pb-Free" mean semiconductor products that are compatible with the current RoHS requirements for all 6 substances, including the requirement that lead not exceed 0.1% by weight in homogeneous materials. Where designed to be soldered at high temperatures, TI Pb-Free products are suitable for use in specified lead-free processes.

Pb-Free (RoHS Exempt): This component has a RoHS exemption for either 1) lead-based flip-chip solder bumps used between the die and package, or 2) lead-based die adhesive used between the die and leadframe. The component is otherwise considered Pb-Free (RoHS compatible) as defined above.

Green (RoHS & no Sb/Br): TI defines "Green" to mean Pb-Free (RoHS compatible), and free of Bromine (Br) and Antimony (Sb) based flame retardants (Br or Sb do not exceed 0.1% by weight in homogeneous material)

(3) MSL, Peak Temp. -- The Moisture Sensitivity Level rating according to the JEDEC industry standard classifications, and peak solder temperature.

(4) Only one of markings shown within the brackets will appear on the physical device.

Important Information and Disclaimer: The information provided on this page represents TI's knowledge and belief as of the date that it is provided. TI bases its knowledge and belief on information provided by third parties, and makes no representation or warranty as to the accuracy of such information. Efforts are underway to better integrate information from third parties. TI has taken and continues to take reasonable steps to provide representative and accurate information but may not have conducted destructive testing or chemical analysis on incoming materials and chemicals. TI and TI suppliers consider certain information to be proprietary, and thus CAS numbers and other limited information may not be available for release.

In no event shall TI's liability arising out of such information exceed the total purchase price of the TI part(s) at issue in this document sold by TI to Customer on an annual basis.

TAPE AND REEL INFORMATION

REEL DIMENSIONS



TAPE DIMENSIONS



A0	Dimension designed to accommodate the component width
B0	Dimension designed to accommodate the component length
K0	Dimension designed to accommodate the component thickness
W	Overall width of the carrier tape
P1	Pitch between successive cavity centers

TAPE AND REEL INFORMATION

*All dimensions are nominal

Device	Package Type	Package Drawing	Pins	SPQ	Reel Diameter (mm)	Reel Width W1 (mm)	A0 (mm)	B0 (mm)	K0 (mm)	P1 (mm)	W (mm)	Pin1 Quadrant
CDC2509CPWR	TSSOP	PW	24	2000	330.0	16.4	6.95	8.3	1.6	8.0	16.0	Q1

TAPE AND REEL BOX DIMENSIONS



*All dimensions are nominal

Device	Package Type	Package Drawing	Pins	SPQ	Length (mm)	Width (mm)	Height (mm)
CDC2509CPWR	TSSOP	PW	24	2000	367.0	367.0	38.0

PW (R-PDSO-G24)

PLASTIC SMALL OUTLINE



4040064-6/G 02/11

- NOTES:
- A. All linear dimensions are in millimeters. Dimensioning and tolerancing per ASME Y14.5M-1994.
 - B. This drawing is subject to change without notice.
 - C. Body length does not include mold flash, protrusions, or gate burrs. Mold flash, protrusions, or gate burrs shall not exceed 0,15 each side.
 - D. Body width does not include interlead flash. Interlead flash shall not exceed 0,25 each side.
 - E. Falls within JEDEC MO-153

PW (R-PDSO-G24)

PLASTIC SMALL OUTLINE

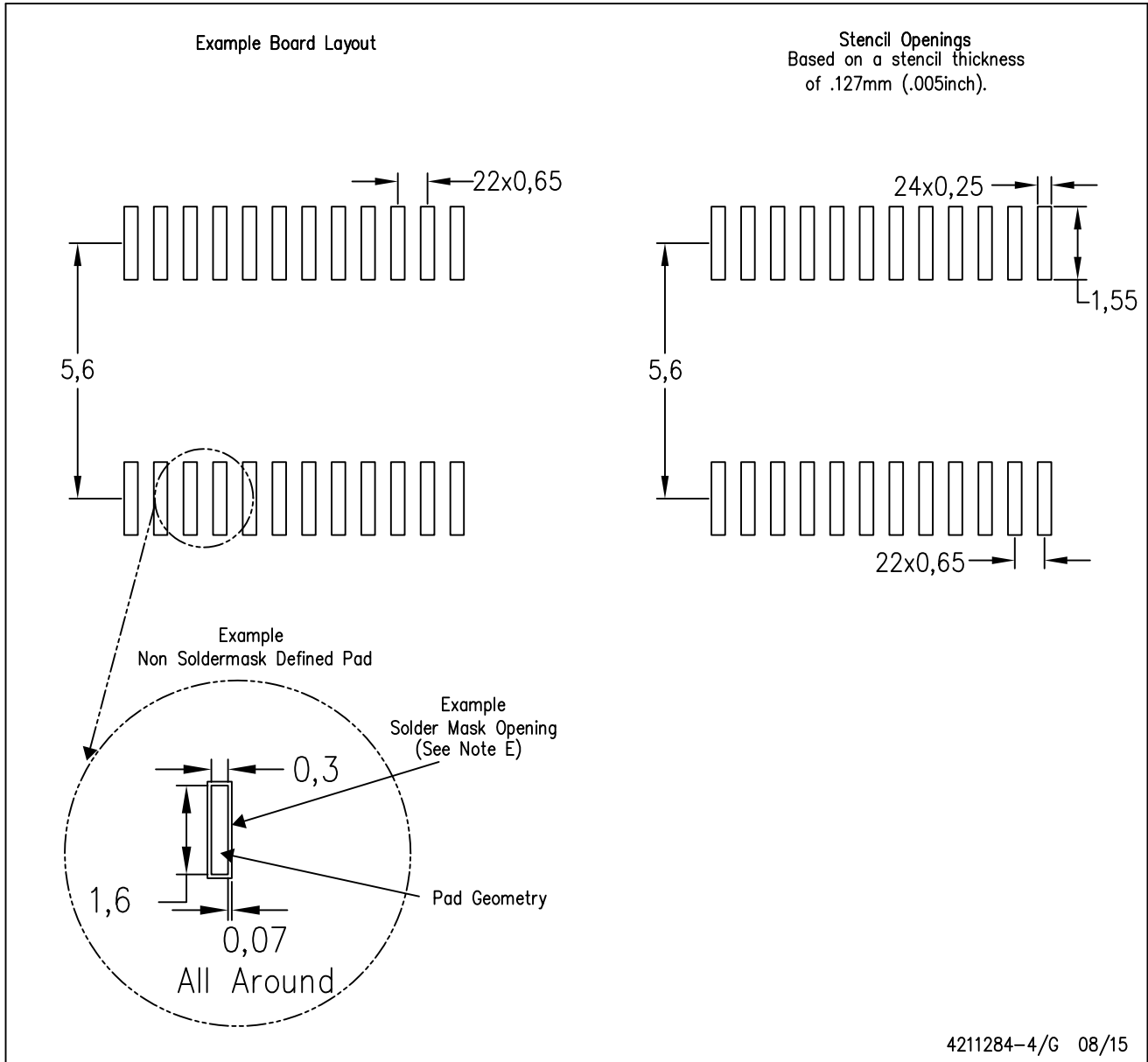

4211284-4/G 08/15

- NOTES:
- A. All linear dimensions are in millimeters.
 - B. This drawing is subject to change without notice.
 - C. Publication IPC-7351 is recommended for alternate design.
 - D. Laser cutting apertures with trapezoidal walls and also rounding corners will offer better paste release. Customers should contact their board assembly site for stencil design recommendations. Refer to IPC-7525 for other stencil recommendations.
 - E. Customers should contact their board fabrication site for solder mask tolerances between and around signal pads.

IMPORTANT NOTICE

Texas Instruments Incorporated and its subsidiaries (TI) reserve the right to make corrections, enhancements, improvements and other changes to its semiconductor products and services per JESD46, latest issue, and to discontinue any product or service per JESD48, latest issue. Buyers should obtain the latest relevant information before placing orders and should verify that such information is current and complete. All semiconductor products (also referred to herein as "components") are sold subject to TI's terms and conditions of sale supplied at the time of order acknowledgment.

TI warrants performance of its components to the specifications applicable at the time of sale, in accordance with the warranty in TI's terms and conditions of sale of semiconductor products. Testing and other quality control techniques are used to the extent TI deems necessary to support this warranty. Except where mandated by applicable law, testing of all parameters of each component is not necessarily performed.

TI assumes no liability for applications assistance or the design of Buyers' products. Buyers are responsible for their products and applications using TI components. To minimize the risks associated with Buyers' products and applications, Buyers should provide adequate design and operating safeguards.

TI does not warrant or represent that any license, either express or implied, is granted under any patent right, copyright, mask work right, or other intellectual property right relating to any combination, machine, or process in which TI components or services are used. Information published by TI regarding third-party products or services does not constitute a license to use such products or services or a warranty or endorsement thereof. Use of such information may require a license from a third party under the patents or other intellectual property of the third party, or a license from TI under the patents or other intellectual property of TI.

Reproduction of significant portions of TI information in TI data books or data sheets is permissible only if reproduction is without alteration and is accompanied by all associated warranties, conditions, limitations, and notices. TI is not responsible or liable for such altered documentation. Information of third parties may be subject to additional restrictions.

Resale of TI components or services with statements different from or beyond the parameters stated by TI for that component or service voids all express and any implied warranties for the associated TI component or service and is an unfair and deceptive business practice. TI is not responsible or liable for any such statements.

Buyer acknowledges and agrees that it is solely responsible for compliance with all legal, regulatory and safety-related requirements concerning its products, and any use of TI components in its applications, notwithstanding any applications-related information or support that may be provided by TI. Buyer represents and agrees that it has all the necessary expertise to create and implement safeguards which anticipate dangerous consequences of failures, monitor failures and their consequences, lessen the likelihood of failures that might cause harm and take appropriate remedial actions. Buyer will fully indemnify TI and its representatives against any damages arising out of the use of any TI components in safety-critical applications.

In some cases, TI components may be promoted specifically to facilitate safety-related applications. With such components, TI's goal is to help enable customers to design and create their own end-product solutions that meet applicable functional safety standards and requirements. Nonetheless, such components are subject to these terms.

No TI components are authorized for use in FDA Class III (or similar life-critical medical equipment) unless authorized officers of the parties have executed a special agreement specifically governing such use.

Only those TI components which TI has specifically designated as military grade or "enhanced plastic" are designed and intended for use in military/aerospace applications or environments. Buyer acknowledges and agrees that any military or aerospace use of TI components which have **not** been so designated is solely at the Buyer's risk, and that Buyer is solely responsible for compliance with all legal and regulatory requirements in connection with such use.

TI has specifically designated certain components as meeting ISO/TS16949 requirements, mainly for automotive use. In any case of use of non-designated products, TI will not be responsible for any failure to meet ISO/TS16949.

Products

Audio	www.ti.com/audio
Amplifiers	amplifier.ti.com
Data Converters	dataconverter.ti.com
DLP® Products	www.dlp.com
DSP	dsp.ti.com
Clocks and Timers	www.ti.com/clocks
Interface	interface.ti.com
Logic	logic.ti.com
Power Mgmt	power.ti.com
Microcontrollers	microcontroller.ti.com
RFID	www.ti-rfid.com
OMAP Applications Processors	www.ti.com/omap
Wireless Connectivity	www.ti.com/wirelessconnectivity

Applications

Automotive and Transportation	www.ti.com/automotive
Communications and Telecom	www.ti.com/communications
Computers and Peripherals	www.ti.com/computers
Consumer Electronics	www.ti.com/consumer-apps
Energy and Lighting	www.ti.com/energy
Industrial	www.ti.com/industrial
Medical	www.ti.com/medical
Security	www.ti.com/security
Space, Avionics and Defense	www.ti.com/space-avionics-defense
Video and Imaging	www.ti.com/video

TI E2E Community

e2e.ti.com