

CDCF2510

3.3-V PHASE-LOCK LOOP CLOCK DRIVER

SCAS628D – APRIL 1999 – REVISED DECEMBER 2004

- Use **CDCVF2510A** as a Replacement for this Device
- Designed to Meet PC133 SDRAM Registered DIMM Specification Rev. 0.9
- Spread Spectrum Clock Compatible
- Operating Frequency 25 MHz to 140 MHz
- Static Phase Error Distribution at 66 MHz to 133 MHz is ± 125 ps
- Jitter (cyc–cyc) at 66 MHz to 133 MHz Is $|70|$ ps
- Available in Plastic 24-Pin TSSOP
- Phase-Lock Loop Clock Distribution for Synchronous DRAM Applications
- Distributes One Clock Input to One Bank of 10 Outputs
- Output Enable Pin to Enable/Disable All 10 Outputs
- External Feedback (FBIN) Terminal Is Used to Synchronize the Outputs to the Clock Input
- On-Chip Series Damping Resistors
- No External RC Network Required
- Operates at 3.3 V

PW PACKAGE
(TOP VIEW)

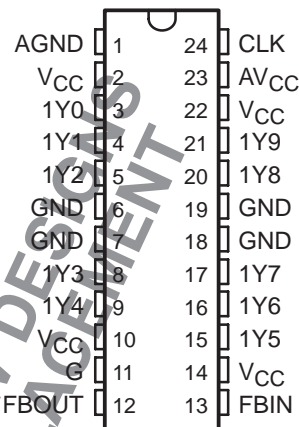

description

The CDCF2510 is a high-performance, low-skew, low-jitter, phase-lock loop (PLL) clock driver. It uses a PLL to precisely align, in both frequency and phase, the feedback (FBOUT) output to the clock (CLK) input signal. It is specifically designed for use with synchronous DRAMs. The CDCF2510 operates at a 3.3-V V_{CC}. It also provides integrated series-damping resistors that make it ideal for driving point-to-point loads.

One bank of ten outputs provide ten low-skew, low-jitter copies of CLK. Output signal duty cycles are adjusted to 50%, independent of the duty cycle at CLK. The outputs can be enabled/disabled with the control (G) input. When the G input is high, the outputs switch in phase and frequency with CLK; when the G input is low, the outputs are disabled to the logic-low state.

Unlike many products containing PLLs, the CDCF2510 does not require external RC networks. The loop filter for the PLL is included on-chip, minimizing component count, board space, and cost.

Because it is based on PLL circuitry, the CDCF2510 requires a stabilization time to achieve phase lock of the feedback signal to the reference signal. This stabilization time is required following power up and application of a fixed-frequency, fixed-phase signal at CLK, and following any changes to the PLL reference or feedback signals. The PLL can be bypassed for test purposes by strapping AV_{CC} to ground.

The CDCF2510 is characterized for operation from 0°C to 85°C.

For application information see the *High Speed Distribution Design Techniques for CDC509/516/2509/2510/2516* (literature number SLMA003) and *Using CDC2509A/2510A PLL with Spread Spectrum Clocking (SSC)* (literature number SCAA039) application reports.



Please be aware that an important notice concerning availability, standard warranty, and use in critical applications of Texas Instruments semiconductor products and disclaimers thereto appears at the end of this data sheet.

PRODUCTION DATA information is current as of publication date. Products conform to specifications per the terms of Texas Instruments standard warranty. Production processing does not necessarily include testing of all parameters.

 **TEXAS
INSTRUMENTS**

POST OFFICE BOX 655303 • DALLAS, TEXAS 75265

Copyright © 2004, Texas Instruments Incorporated

CDCF2510

3.3-V PHASE-LOCK LOOP CLOCK DRIVER

SCAS628D – APRIL 1999 – REVISED DECEMBER 2004

FUNCTION TABLE

| INPUTS | | OUTPUTS | |
|--------|-----|----------|-------|
| G | CLK | 1Y (0:9) | FBOUT |
| X | L | L | L |
| L | H | L | H |
| H | H | H | H |

functional block diagram

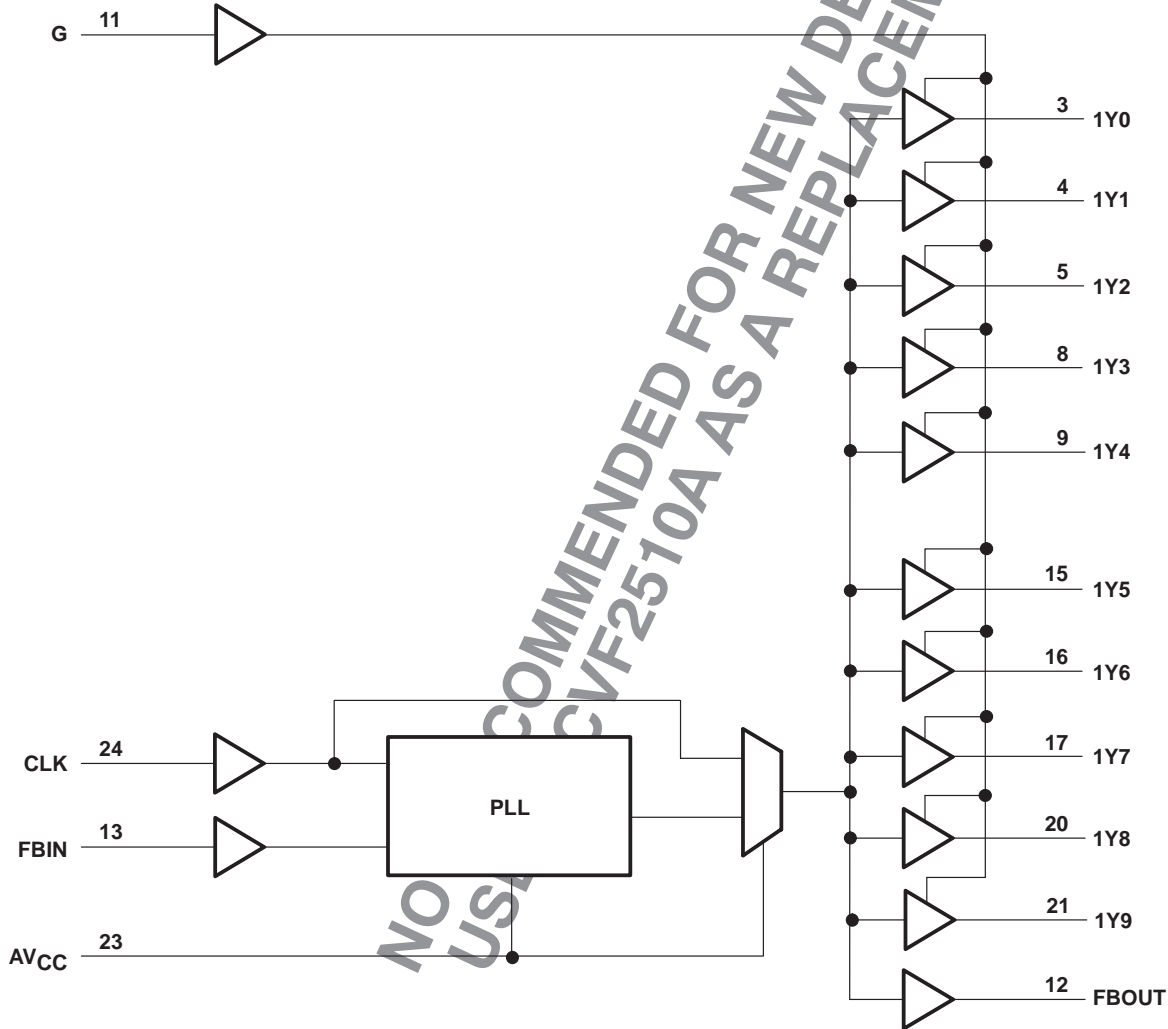

AVAILABLE OPTIONS

| T _A | PACKAGE |
|----------------|--------------------|
| | SMALL OUTLINE (PW) |
| 0°C to 85°C | CDCF2510PWR |

CDCF2510

3.3-V PHASE-LOCK LOOP CLOCK DRIVER

SCAS628D – APRIL 1999 – REVISED DECEMBER 2004

Terminal Functions

| TERMINAL NAME | NO. | TYPE | DESCRIPTION |
|------------------|---|--------|---|
| CLK | 24 | I | Clock input. CLK provides the clock signal to be distributed by the CDCF2510 clock driver. CLK is used to provide the reference signal to the integrated PLL that generates the clock output signals. CLK must have a fixed frequency and fixed phase for the PLL to obtain phase lock. Once the circuit is powered up and a valid CLK signal is applied, a stabilization time is required for the PLL to phase lock the feedback signal to its reference signal. |
| FBIN | 13 | I | Feedback input. FBIN provides the feedback signal to the internal PLL. FBIN must be hard-wired to FBOUT to complete the PLL. The integrated PLL synchronizes CLK and FBIN so that there is nominally zero phase error between CLK and FBIN. |
| G | 11 | I | Output bank enable. G is the output enable for outputs 1Y(0:9). When G is low, outputs 1Y(0:9) are disabled to a logic-low state. When G is high, all outputs 1Y(0:9) are enabled and switch at the same frequency as CLK. |
| FBOUT | 12 | O | Feedback output. FBOUT is dedicated for external feedback. It switches at the same frequency as CLK. When externally wired to FBIN, FBOUT completes the feedback loop of the PLL. FBOUT has an integrated 25-Ω series-damping resistor. |
| 1Y (0:9) | 3, 4, 5, 8, 9, 15, 16, 17, 20, 21 | O | Clock outputs. These outputs provide low-skew copies of CLK. Output bank 1Y(0:9) is enabled via the G input. These outputs can be disabled to a logic-low state by deasserting the G control input. Each output has an integrated 25-Ω series-damping resistor. |
| AV _{CC} | 23 | Power | Analog power supply. AV _{CC} provides the power reference for the analog circuitry. In addition, AV _{CC} can be used to bypass the PLL for test purposes. When AV _{CC} is strapped to ground, PLL is bypassed and CLK is buffered directly to the device outputs. |
| AGND | 1 | Ground | Analog ground. AGND provides the ground reference for the analog circuitry. |
| V _{CC} | 2, 10, 14, 22 | Power | Power supply |
| GND | 6, 7, 18, 19 | Ground | Ground |

NOT RECOMMENDED FOR NEW DESIGNS
USE CDCVF2510A AS REPLACEMENT



CDCF2510

3.3-V PHASE-LOCK LOOP CLOCK DRIVER

SCAS628D – APRIL 1999 – REVISED DECEMBER 2004

absolute maximum ratings over operating free-air temperature range (unless otherwise noted)[†]

| | |
|--|--|
| Supply voltage range, AV_{CC} (see Note 1) | $AV_{CC} < V_{CC} + 0.7\text{ V}$ |
| Supply voltage range, V_{CC} | -0.5 V to 4.6 V |
| Input voltage range, V_I (see Note 2) | -0.5 V to 6.5 V |
| Voltage range applied to any output in the high or low state, V_O (see Notes 2 and 3) | -0.5 V to $V_{CC} + 0.5\text{ V}$ |
| Input clamp current, I_{IK} ($V_I < 0$) | -50 mA |
| Output clamp current, I_{OK} ($V_O < 0$ or $V_O > V_{CC}$) | $\pm 50\text{ mA}$ |
| Continuous output current, I_O ($V_O = 0$ to V_{CC}) | $\pm 50\text{ mA}$ |
| Continuous current through each V_{CC} or GND | $\pm 100\text{ mA}$ |
| Maximum power dissipation at $T_A = 55^\circ\text{C}$ (in still air) (see Note 4) | 0.7 W |
| Storage temperature range, T_{stg} | -65°C to 150°C |

[†] Stresses beyond those listed under “absolute maximum ratings” may cause permanent damage to the device. These are stress ratings only, and functional operation of the device at these or any other conditions beyond those indicated under “recommended operating conditions” is not implied. Exposure to absolute-maximum-rated conditions for extended periods may affect device reliability.

NOTES: 1. AV_{CC} must not exceed V_{CC} .

2. The input and output negative-voltage ratings may be exceeded if the input and output clamp-current ratings are observed.

3. This value is limited to 4.6 V maximum.

4. The maximum package power dissipation is calculated using a junction temperature of 150°C and a board trace length of 750 mils. For more information, refer to the *Package Thermal Considerations* application note in the *ABT Advanced BiCMOS Technology Data Book*, literature number SCBD002.

recommended operating conditions (see Note 5)

| | MIN | MAX | UNIT |
|---------------------------------------|-----|----------|------------------|
| Supply voltage, V_{CC} , AV_{CC} | 3 | 3.6 | V |
| High-level input voltage, V_{IH} | 2 | | V |
| Low-level input voltage, V_{IL} | | 0.8 | V |
| Input voltage, V_I | 0 | V_{CC} | V |
| High-level output current, I_{OH} | | -12 | mA |
| Low-level output current, I_{OL} | | 12 | mA |
| Operating free-air temperature, T_A | 0 | 85 | $^\circ\text{C}$ |

NOTE 5: Unused inputs must be held high or low to prevent them from floating.

timing requirements over recommended ranges of supply voltage and operating free-air temperature

| | MIN | MAX | UNIT |
|---------------------------------|-----|-----|------|
| f_{clk} Clock frequency | 25 | 140 | MHz |
| Input clock duty cycle | 40% | 60% | |
| Stabilization time [‡] | | 1 | ms |

[‡] Time required for the integrated PLL circuit to obtain phase lock of its feedback signal to its reference signal. For phase lock to be obtained, a fixed-frequency, fixed-phase reference signal must be present at CLK. Until phase lock is obtained, the specifications for propagation delay, skew, and jitter parameters given in the switching characteristics table are not applicable. This parameter does not apply for input modulation under SSC application.



CDCF2510

3.3-V PHASE-LOCK LOOP CLOCK DRIVER

SCAS628D – APRIL 1999 – REVISED DECEMBER 2004

electrical characteristics over recommended operating free-air temperature range (unless otherwise noted)

| PARAMETER | | TEST CONDITIONS | V _{CC} , AV _{CC} | MIN | TYP† | MAX | UNIT |
|-------------------|---------------------------|---|------------------------------------|----------------------|------|------|------|
| V _{IK} | Input clamp voltage | I _I = -18 mA | 3 V | | | -1.2 | V |
| V _{OH} | High-level output voltage | I _{OH} = -100 μA | MIN to MAX | V _{CC} -0.2 | | | V |
| | | I _{OH} = -12 mA | 3 V | | 2.1 | | |
| | | I _{OH} = -6 mA | 3 V | | 2.4 | | |
| V _{OL} | Low-level output voltage | I _{OL} = 100 μA | MIN to MAX | | | 0.2 | V |
| | | I _{OL} = 12 mA | 3 V | | | 0.8 | |
| | | I _{OL} = 6 mA | 3 V | | | 0.55 | |
| I _{OH} | High-level output current | V _O = 1 V | 3.135 V | -32 | | | |
| | | V _O = 1.65 V | 3.3 V | | -36 | | |
| | | V _O = 3.135 V | 3.465 V | | | -12 | |
| I _{OL} | Low-level output current | V _O = 1.95 V | 3.135 V | 34 | | | |
| | | V _O = 1.65 V | 3.3 V | | 40 | | |
| | | V _O = 0.4 V | 3.465 V | | | 14 | |
| I _I | Input current | V _I = V _{CC} or GND | 3.6 V | | | ±5 | μA |
| I _{CC} § | Supply current | V _I = V _{CC} or GND, I _O = 0, Outputs: low or high | 3.6 V | | | 10 | μA |
| ΔI _{CC} | Change in supply current | One input at V _{CC} - 0.6 V, Other inputs at V _{CC} or GND | 3.3 V to 3.6 V | | | 500 | μA |
| C _i | Input capacitance | V _I = V _{CC} or GND | 3.3 V | | 4 | | pF |
| C _o | Output capacitance | V _O = V _{CC} or GND | 3.3 V | | 6 | | pF |

† For conditions shown as MIN or MAX, use the appropriate value specified under recommended operating conditions.

‡ For I_{CC} of AV_{CC}, and I_{CC} vs Frequency (see Figures 8 and 9).

switching characteristics over recommended ranges of supply voltage and operating free-air temperature, C_L = 25 pF (see Note 6 and Figures 1 and 2)§

| PARAMETER | FROM (INPUT) | TO (OUTPUT) | V _{CC} , AV _{CC} = 3.3 V ± 0.3 V | | | UNIT |
|--|--|----------------|--|------|------|------|
| | | | MIN | TYP | MAX | |
| Phase error time – static (normalized) (See Figures 3 – 6) | CLKIN↑ = 66 MHz to 133 MHz | FBIN↑ | -125 | | 125 | ps |
| t _{sk(o)} Output skew time¶ | Any Y or FBOUT | Any Y or FBOUT | | | 200 | ps |
| Phase error time – jitter (see Note 7) | Clkin = 66 MHz to 100 MHz | Any Y or FBOUT | -50 | | 50 | ps |
| Jitter _(cycle-cycle) (See Figure 7) | | Any Y or FBOUT | | [70] | | |
| | Clkin = 100 MHz to 133 MHz | Any Y or FBOUT | | | [65] | ps |
| Duty cycle | F(dkin > 60 MHz) | Any Y or FBOUT | 45% | | 55% | |
| t _r Rise time (See Notes 8 and 9) | V _O = 1.2 V to 1.8 V, IBIS simulation | Any Y or FBOUT | 2.5 | | 1 | V/ns |
| t _f Fall time (See Notes 8 and 9) | V _O = 1.2 V to 1.8 V, IBIS simulation | Any Y or FBOUT | 2.5 | | 1 | V/ns |

§ These parameters are not production tested.

¶ The t_{sk(o)} specification is only valid for equal loading of all outputs.

NOTES: 6. The specifications for parameters in this table are applicable only after any appropriate stabilization time has elapsed.

7. Calculated per PC DRAM SPEC (t_{phase error, static - jitter(cycle-to-cycle)}).

8. This is equivalent to 0.8 ns/2.5 ns and 0.8 ns/2.7 ns into standard 500 Ω/ 30 pF load for output swing of 0.4 V to 2 V.

9. 64 MB DIMM configuration according to PC SDRAM Registered DIMM Design Support Document, Figure 20 and Table 13.

Intel is a trademark of Intel Corporation.

PC SDRAM Register DIMM Design Support Document is published by Intel Corporation.



CDCF2510

3.3-V PHASE-LOCK LOOP CLOCK DRIVER

SCAS628D – APRIL 1999 – REVISED DECEMBER 2004

PARAMETER MEASUREMENT INFORMATION

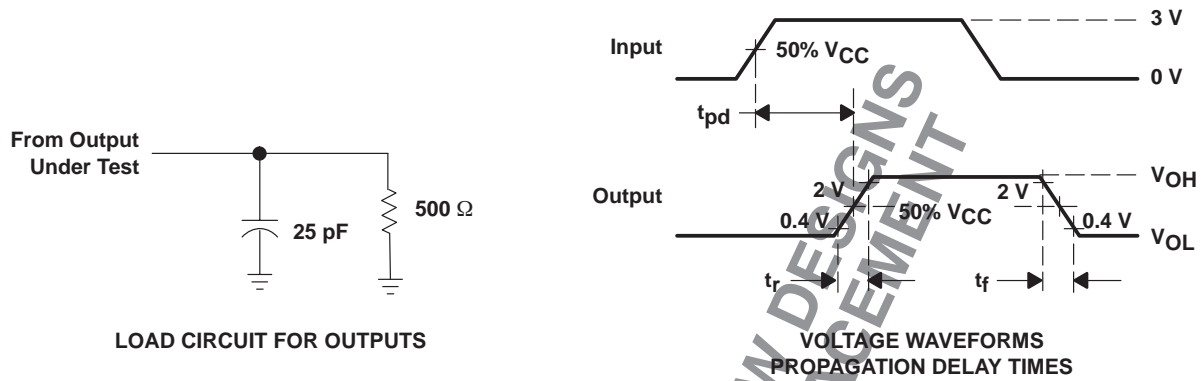

- NOTES:
- A. C_L includes probe and jig capacitance.
 - B. All input pulses are supplied by generators having the following characteristics: PRR \leq 133 MHz, $Z_O = 50 \Omega$, $t_r \leq 1.2$ ns, $t_f \leq 1.2$ ns.
 - C. The outputs are measured one at a time with one transition per measurement.

Figure 1. Load Circuit and Voltage Waveforms

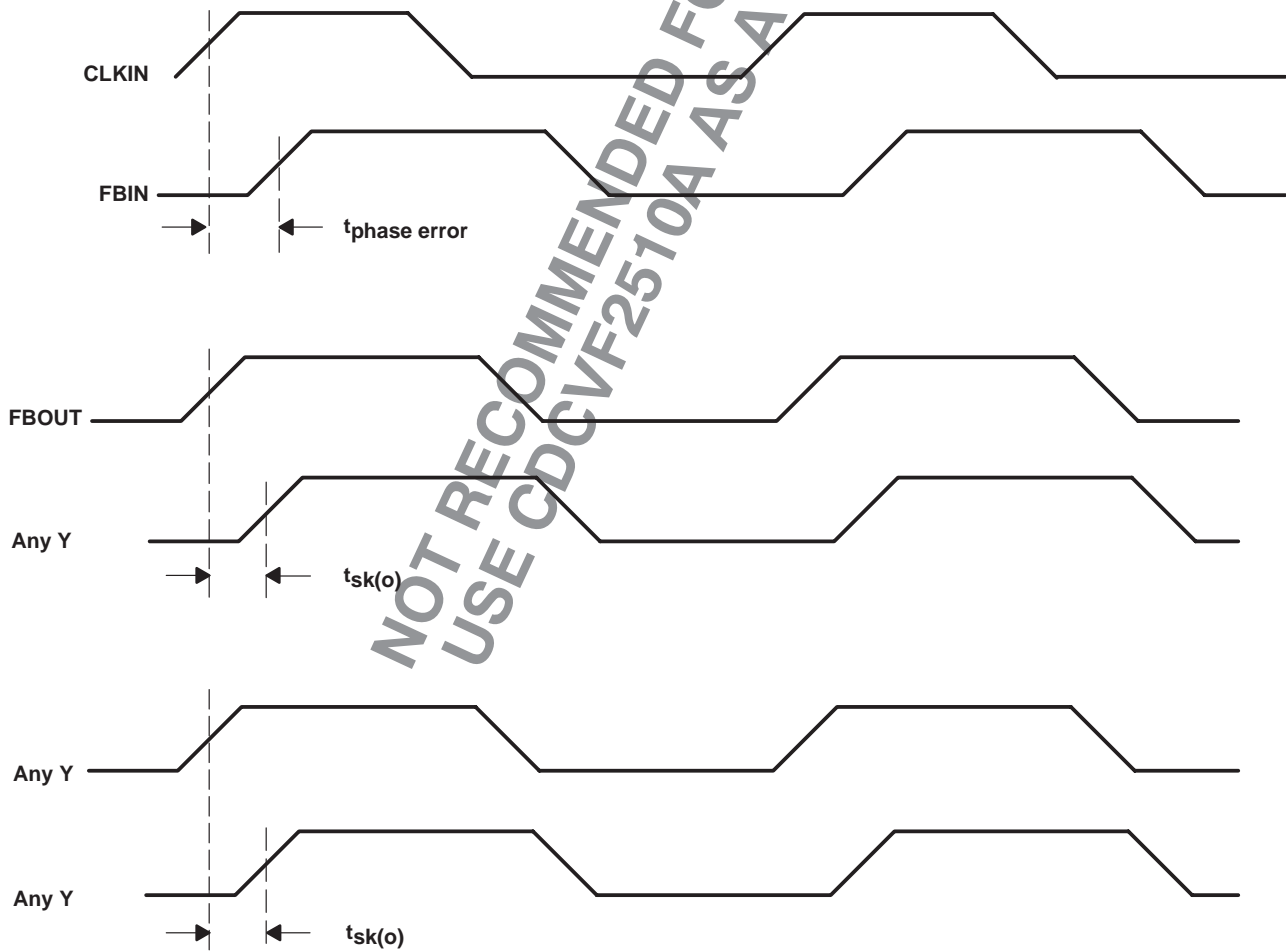
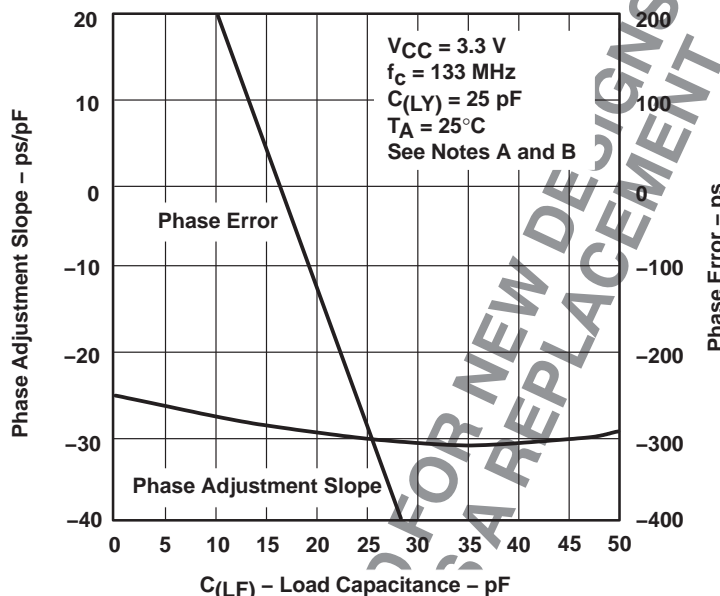

Figure 2. Phase Error and Skew Calculations

TYPICAL CHARACTERISTICS

PHASE ADJUSTMENT SLOPE AND PHASE ERROR
vs
LOAD CAPACITANCE



NOTES: A. Trace feedback length FBOUT to FBIN = 5 mm, $Z_O = 50\ \Omega$ Phase error measured from CLK to Y_N
 B. $C(LF)$ = Lumped feedback capacitance at FBIN

Figure 3

PHASE ERROR
vs
CLOCK FREQUENCY

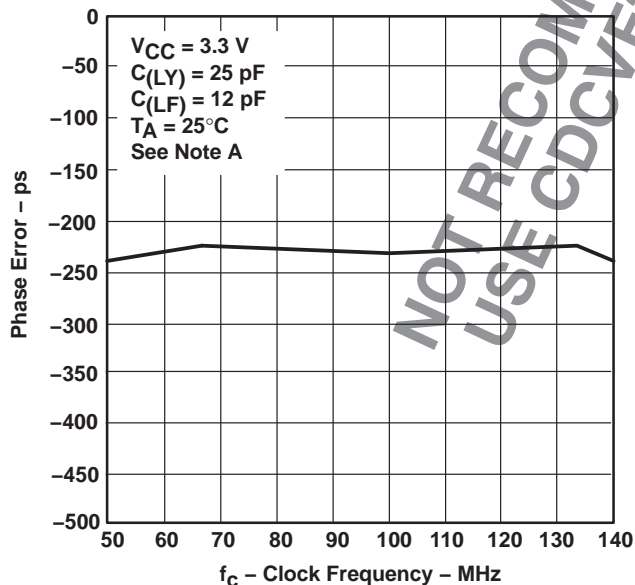

Figure 4

PHASE ERROR
vs
SUPPLY VOLTAGE

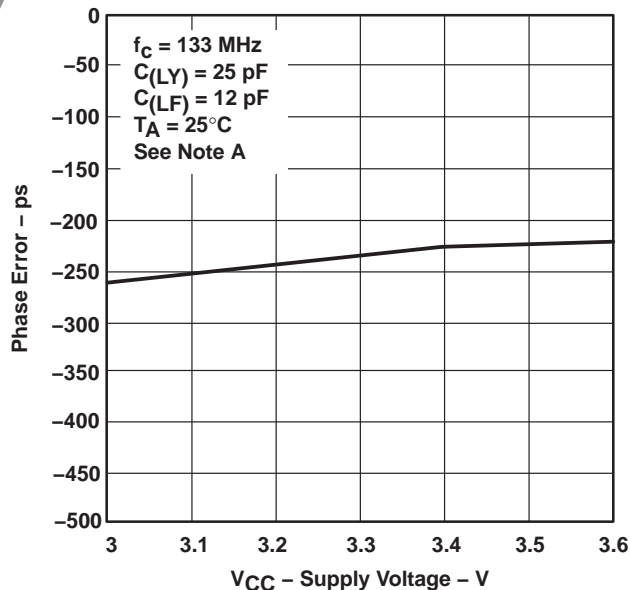

Figure 5

NOTE A: Trace feedback length FBOUT to FBIN = 5 mm, $Z_O = 50\ \Omega$

CDCF2510

3.3-V PHASE-LOCK LOOP CLOCK DRIVER

SCAS628D – APRIL 1999 – REVISED DECEMBER 2004

TYPICAL CHARACTERISTICS

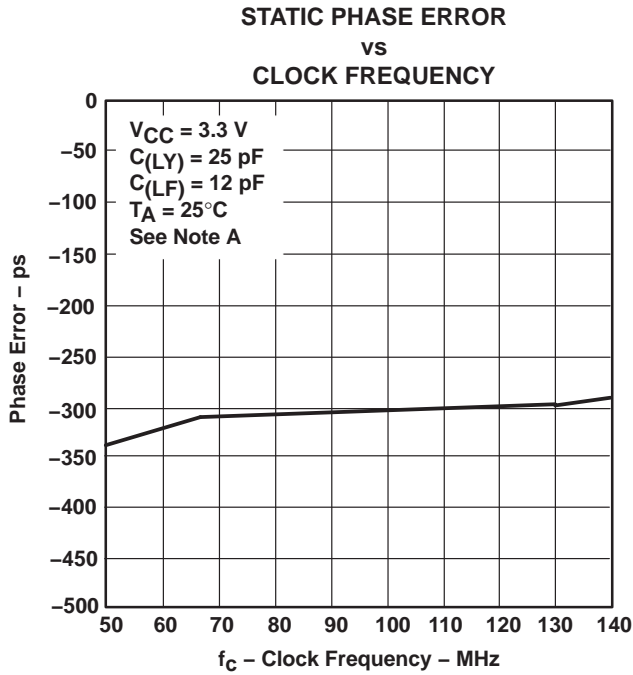

Figure 6

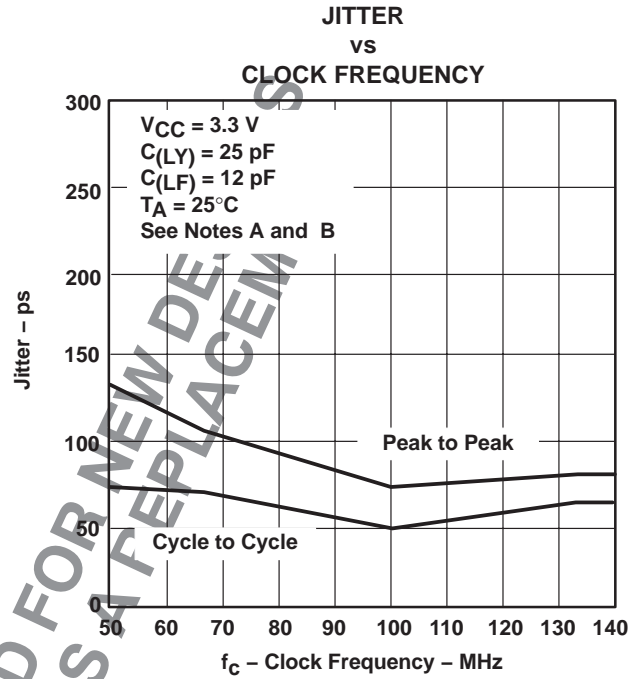

Figure 7

- NOTES: A. Trace feedback length FBOUT to FBIN = 5 mm, $Z_O = 50\ \Omega$
 B. Phase error measured from CLK to FBIN
 C. $C_{(LY)}$ = Lumped capacitive load at Y
 D. $C_{(LF)}$ = Lumped feedback capacitance at FBIN

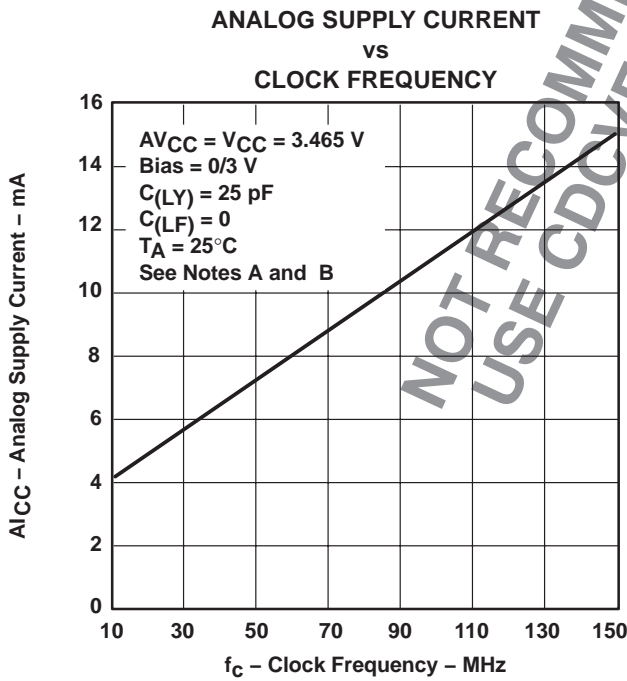

Figure 8

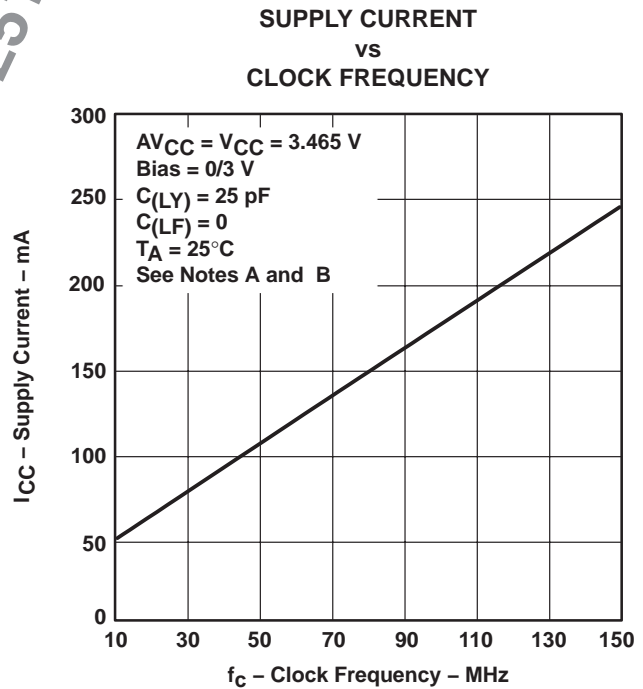

Figure 9

- NOTES: A. $C_{(LY)}$ = Lumped capacitive load at Y
 B. $C_{(LF)}$ = Lumped feedback capacitance at FBIN

PACKAGING INFORMATION

| Orderable Device | Status (1) | Package Type | Package Drawing | Pins | Package Qty | Eco Plan (2) | Lead/Ball Finish (6) | MSL Peak Temp (3) | Op Temp (°C) | Device Marking (4/5) | Samples |
|------------------|---------------|--------------|--------------------|------|----------------|----------------------------|-------------------------|----------------------|--------------|-------------------------|---------|
| CDCF2510PW | LIFEBUY | TSSOP | PW | 24 | 60 | Green (RoHS & no Sb/Br) | CU NIPDAU | Level-1-260C-UNLIM | 0 to 70 | CDCF2510 | |
| CDCF2510PWG4 | LIFEBUY | TSSOP | PW | 24 | 60 | Green (RoHS & no Sb/Br) | CU NIPDAU | Level-1-260C-UNLIM | 0 to 70 | CDCF2510 | |
| CDCF2510PWR | LIFEBUY | TSSOP | PW | 24 | 2000 | Green (RoHS & no Sb/Br) | CU NIPDAU | Level-1-260C-UNLIM | 0 to 70 | CDCF2510 | |
| CDCF2510PWRG4 | LIFEBUY | TSSOP | PW | 24 | 2000 | Green (RoHS & no Sb/Br) | CU NIPDAU | Level-1-260C-UNLIM | 0 to 70 | CDCF2510 | |
| HPA00016PWR | LIFEBUY | TSSOP | PW | 24 | 2000 | Green (RoHS & no Sb/Br) | CU NIPDAU | Level-1-260C-UNLIM | 0 to 70 | CDCF2510 | |

(1) The marketing status values are defined as follows:

ACTIVE: Product device recommended for new designs.

LIFEBUY: TI has announced that the device will be discontinued, and a lifetime-buy period is in effect.

NRND: Not recommended for new designs. Device is in production to support existing customers, but TI does not recommend using this part in a new design.

PREVIEW: Device has been announced but is not in production. Samples may or may not be available.

OBsolete: TI has discontinued the production of the device.

(2) **RoHS:** TI defines "RoHS" to mean semiconductor products that are compliant with the current EU RoHS requirements for all 10 RoHS substances, including the requirement that RoHS substance do not exceed 0.1% by weight in homogeneous materials. Where designed to be soldered at high temperatures, "RoHS" products are suitable for use in specified lead-free processes. TI may reference these types of products as "Pb-Free".

RoHS Exempt: TI defines "RoHS Exempt" to mean products that contain lead but are compliant with EU RoHS pursuant to a specific EU RoHS exemption.

Green: TI defines "Green" to mean the content of Chlorine (Cl) and Bromine (Br) based flame retardants meet JS709B low halogen requirements of <=1000ppm threshold. Antimony trioxide based flame retardants must also meet the <=1000ppm threshold requirement.

(3) MSL, Peak Temp. - The Moisture Sensitivity Level rating according to the JEDEC industry standard classifications, and peak solder temperature.

(4) There may be additional marking, which relates to the logo, the lot trace code information, or the environmental category on the device.

(5) Multiple Device Markings will be inside parentheses. Only one Device Marking contained in parentheses and separated by a "-" will appear on a device. If a line is indented then it is a continuation of the previous line and the two combined represent the entire Device Marking for that device.

(6) Lead/Ball Finish - Orderable Devices may have multiple material finish options. Finish options are separated by a vertical ruled line. Lead/Ball Finish values may wrap to two lines if the finish value exceeds the maximum column width.

Important Information and Disclaimer: The information provided on this page represents TI's knowledge and belief as of the date that it is provided. TI bases its knowledge and belief on information provided by third parties, and makes no representation or warranty as to the accuracy of such information. Efforts are underway to better integrate information from third parties. TI has taken and continues to take reasonable steps to provide representative and accurate information but may not have conducted destructive testing or chemical analysis on incoming materials and chemicals. TI and TI suppliers consider certain information to be proprietary, and thus CAS numbers and other limited information may not be available for release.

In no event shall TI's liability arising out of such information exceed the total purchase price of the TI part(s) at issue in this document sold by TI to Customer on an annual basis.

TAPE AND REEL INFORMATION

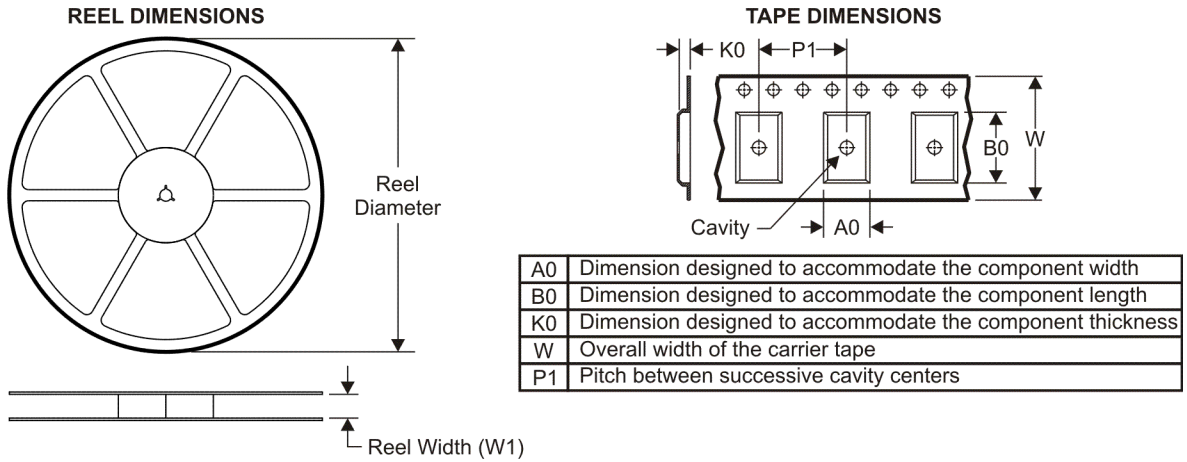

QUADRANT ASSIGNMENTS FOR PIN 1 ORIENTATION IN TAPE



*All dimensions are nominal

| Device | Package Type | Package Drawing | Pins | SPQ | Reel Diameter (mm) | Reel Width W1 (mm) | A0 (mm) | B0 (mm) | K0 (mm) | P1 (mm) | W (mm) | Pin1 Quadrant |
|-------------|--------------|-----------------|------|------|--------------------|--------------------|---------|---------|---------|---------|--------|---------------|
| CDCF2510PWR | TSSOP | PW | 24 | 2000 | 330.0 | 16.4 | 6.95 | 8.3 | 1.6 | 8.0 | 16.0 | Q1 |

TAPE AND REEL BOX DIMENSIONS



*All dimensions are nominal

| Device | Package Type | Package Drawing | Pins | SPQ | Length (mm) | Width (mm) | Height (mm) |
|-------------|--------------|-----------------|------|------|-------------|------------|-------------|
| CDCF2510PWR | TSSOP | PW | 24 | 2000 | 333.2 | 345.9 | 28.6 |

PW (R-PDSO-G24)

PLASTIC SMALL OUTLINE

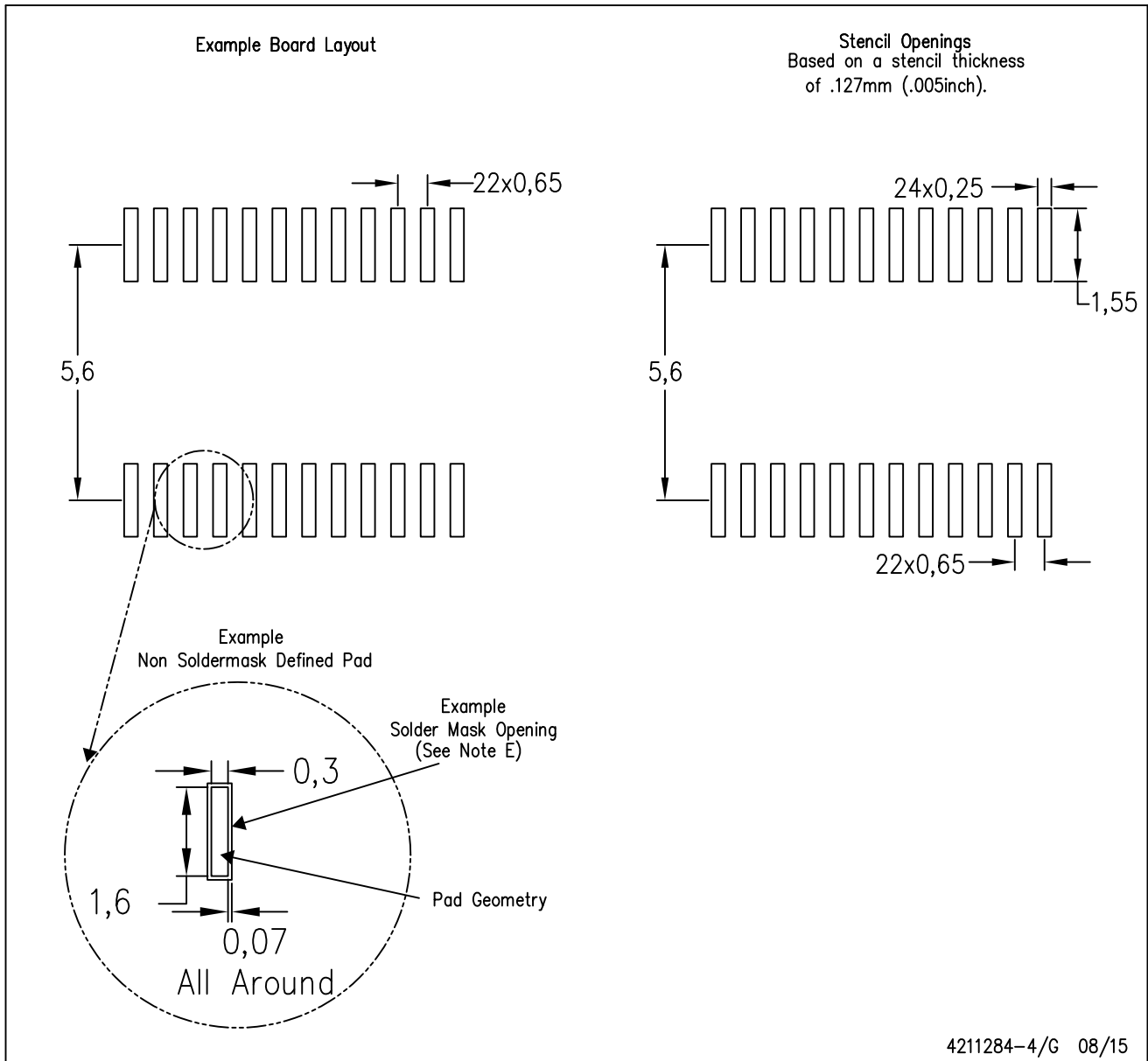

4211284-4/G 08/15

- NOTES:
- A. All linear dimensions are in millimeters.
 - B. This drawing is subject to change without notice.
 - C. Publication IPC-7351 is recommended for alternate design.
 - D. Laser cutting apertures with trapezoidal walls and also rounding corners will offer better paste release. Customers should contact their board assembly site for stencil design recommendations. Refer to IPC-7525 for other stencil recommendations.
 - E. Customers should contact their board fabrication site for solder mask tolerances between and around signal pads.

IMPORTANT NOTICE

Texas Instruments Incorporated (TI) reserves the right to make corrections, enhancements, improvements and other changes to its semiconductor products and services per JESD46, latest issue, and to discontinue any product or service per JESD48, latest issue. Buyers should obtain the latest relevant information before placing orders and should verify that such information is current and complete.

TI's published terms of sale for semiconductor products (<http://www.ti.com/sc/docs/stdterms.htm>) apply to the sale of packaged integrated circuit products that TI has qualified and released to market. Additional terms may apply to the use or sale of other types of TI products and services.

Reproduction of significant portions of TI information in TI data sheets is permissible only if reproduction is without alteration and is accompanied by all associated warranties, conditions, limitations, and notices. TI is not responsible or liable for such reproduced documentation. Information of third parties may be subject to additional restrictions. Resale of TI products or services with statements different from or beyond the parameters stated by TI for that product or service voids all express and any implied warranties for the associated TI product or service and is an unfair and deceptive business practice. TI is not responsible or liable for any such statements.

Buyers and others who are developing systems that incorporate TI products (collectively, "Designers") understand and agree that Designers remain responsible for using their independent analysis, evaluation and judgment in designing their applications and that Designers have full and exclusive responsibility to assure the safety of Designers' applications and compliance of their applications (and of all TI products used in or for Designers' applications) with all applicable regulations, laws and other applicable requirements. Designer represents that, with respect to their applications, Designer has all the necessary expertise to create and implement safeguards that (1) anticipate dangerous consequences of failures, (2) monitor failures and their consequences, and (3) lessen the likelihood of failures that might cause harm and take appropriate actions. Designer agrees that prior to using or distributing any applications that include TI products, Designer will thoroughly test such applications and the functionality of such TI products as used in such applications.

TI's provision of technical, application or other design advice, quality characterization, reliability data or other services or information, including, but not limited to, reference designs and materials relating to evaluation modules, (collectively, "TI Resources") are intended to assist designers who are developing applications that incorporate TI products; by downloading, accessing or using TI Resources in any way, Designer (individually or, if Designer is acting on behalf of a company, Designer's company) agrees to use any particular TI Resource solely for this purpose and subject to the terms of this Notice.

TI's provision of TI Resources does not expand or otherwise alter TI's applicable published warranties or warranty disclaimers for TI products, and no additional obligations or liabilities arise from TI providing such TI Resources. TI reserves the right to make corrections, enhancements, improvements and other changes to its TI Resources. TI has not conducted any testing other than that specifically described in the published documentation for a particular TI Resource.

Designer is authorized to use, copy and modify any individual TI Resource only in connection with the development of applications that include the TI product(s) identified in such TI Resource. NO OTHER LICENSE, EXPRESS OR IMPLIED, BY ESTOPPEL OR OTHERWISE TO ANY OTHER TI INTELLECTUAL PROPERTY RIGHT, AND NO LICENSE TO ANY TECHNOLOGY OR INTELLECTUAL PROPERTY RIGHT OF TI OR ANY THIRD PARTY IS GRANTED HEREIN, including but not limited to any patent right, copyright, mask work right, or other intellectual property right relating to any combination, machine, or process in which TI products or services are used. Information regarding or referencing third-party products or services does not constitute a license to use such products or services, or a warranty or endorsement thereof. Use of TI Resources may require a license from a third party under the patents or other intellectual property of the third party, or a license from TI under the patents or other intellectual property of TI.

TI RESOURCES ARE PROVIDED "AS IS" AND WITH ALL FAULTS. TI DISCLAIMS ALL OTHER WARRANTIES OR REPRESENTATIONS, EXPRESS OR IMPLIED, REGARDING RESOURCES OR USE THEREOF, INCLUDING BUT NOT LIMITED TO ACCURACY OR COMPLETENESS, TITLE, ANY EPIDEMIC FAILURE WARRANTY AND ANY IMPLIED WARRANTIES OF MERCHANTABILITY, FITNESS FOR A PARTICULAR PURPOSE, AND NON-INFRINGEMENT OF ANY THIRD PARTY INTELLECTUAL PROPERTY RIGHTS. TI SHALL NOT BE LIABLE FOR AND SHALL NOT DEFEND OR INDEMNIFY DESIGNER AGAINST ANY CLAIM, INCLUDING BUT NOT LIMITED TO ANY INFRINGEMENT CLAIM THAT RELATES TO OR IS BASED ON ANY COMBINATION OF PRODUCTS EVEN IF DESCRIBED IN TI RESOURCES OR OTHERWISE. IN NO EVENT SHALL TI BE LIABLE FOR ANY ACTUAL, DIRECT, SPECIAL, COLLATERAL, INDIRECT, PUNITIVE, INCIDENTAL, CONSEQUENTIAL OR EXEMPLARY DAMAGES IN CONNECTION WITH OR ARISING OUT OF TI RESOURCES OR USE THEREOF, AND REGARDLESS OF WHETHER TI HAS BEEN ADVISED OF THE POSSIBILITY OF SUCH DAMAGES.

Unless TI has explicitly designated an individual product as meeting the requirements of a particular industry standard (e.g., ISO/TS 16949 and ISO 26262), TI is not responsible for any failure to meet such industry standard requirements.

Where TI specifically promotes products as facilitating functional safety or as compliant with industry functional safety standards, such products are intended to help enable customers to design and create their own applications that meet applicable functional safety standards and requirements. Using products in an application does not by itself establish any safety features in the application. Designers must ensure compliance with safety-related requirements and standards applicable to their applications. Designer may not use any TI products in life-critical medical equipment unless authorized officers of the parties have executed a special contract specifically governing such use. Life-critical medical equipment is medical equipment where failure of such equipment would cause serious bodily injury or death (e.g., life support, pacemakers, defibrillators, heart pumps, neurostimulators, and implantables). Such equipment includes, without limitation, all medical devices identified by the U.S. Food and Drug Administration as Class III devices and equivalent classifications outside the U.S.

TI may expressly designate certain products as completing a particular qualification (e.g., Q100, Military Grade, or Enhanced Product). Designers agree that it has the necessary expertise to select the product with the appropriate qualification designation for their applications and that proper product selection is at Designers' own risk. Designers are solely responsible for compliance with all legal and regulatory requirements in connection with such selection.

Designer will fully indemnify TI and its representatives against any damages, costs, losses, and/or liabilities arising out of Designer's non-compliance with the terms and provisions of this Notice.