



**DAC7744**



For most current data sheet and other product information, visit [www.burr-brown.com](http://www.burr-brown.com)

## 16-Bit, Quad Voltage Output DIGITAL-TO-ANALOG CONVERTER

### FEATURES

- **LOW POWER: 200mW**
- **UNIPOLAR OR BIPOLAR OPERATION**
- **SINGLE-SUPPLY OUTPUT RANGE: +10V**
- **DUAL SUPPLY OUTPUT RANGE:  $\pm 10V$**
- **SETTLING TIME: 10 $\mu$ s to 0.003%**
- **16-BIT MONOTONICITY:  $-40^{\circ}C$  to  $+85^{\circ}C$**
- **PROGRAMMABLE RESET TO MID-SCALE OR ZERO-SCALE**
- **DATA READBACK**
- **DOUBLE-BUFFERED DATA INPUTS**

### APPLICATIONS

- **PROCESS CONTROL**
- **ATE PIN ELECTRONICS**
- **CLOSED-LOOP SERVO-CONTROL**
- **MOTOR CONTROL**
- **DATA ACQUISITION SYSTEMS**
- **DAC-PER-PIN PROGRAMMERS**

### DESCRIPTION

The DAC7744 is a 16-bit, quad voltage output digital-to-analog converter with guaranteed 16-bit monotonic performance over the specified temperature range. It accepts 16-bit parallel input data, has double-buffered DAC input logic (allowing simultaneous update of all DACs), and provides a readback mode of the internal input registers. Programmable asynchronous reset clears all registers to a mid-scale code of 8000<sub>H</sub> or to a zero-scale of 0000<sub>H</sub>. The DAC7744 operates from either a single +15V supply or from a +15V, -15V, and +5V supply.

Low power and small size per DAC make the DAC7744 ideal for automatic test equipment, DAC-per-pin programmers, data acquisition systems, and closed-loop servo-control. The DAC7744 is available in a 48-lead SSOP package, and offers guaranteed specifications over the  $-40^{\circ}C$  to  $+85^{\circ}C$  temperature range.

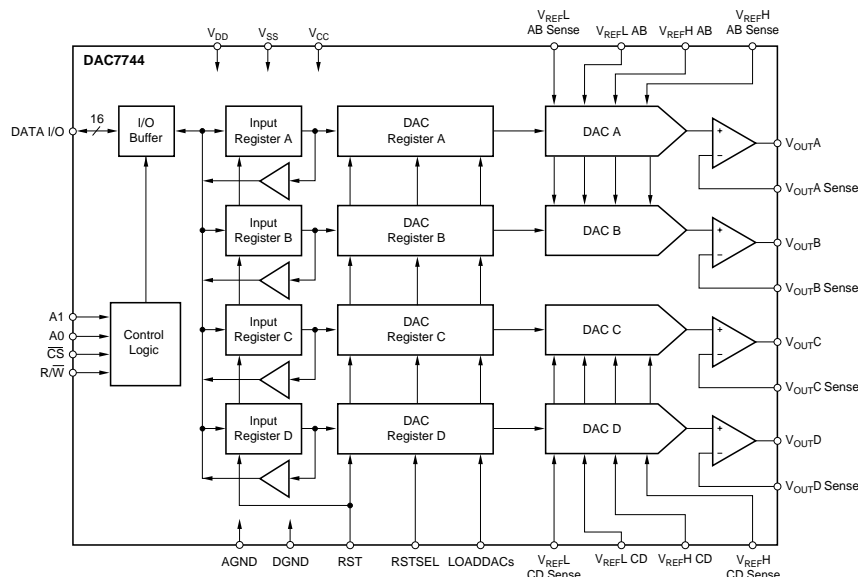

International Airport Industrial Park • Mailing Address: PO Box 11400, Tucson, AZ 85734 • Street Address: 6730 S. Tucson Blvd., Tucson, AZ 85706 • Tel: (520) 746-1111  
 Twx: 910-952-1111 • Internet: <http://www.burr-brown.com/> • Cable: BBRCORP • Telex: 066-6491 • FAX: (520) 889-1510 • Immediate Product Info: (800) 548-6132

# SPECIFICATIONS (Dual Supply)

At  $T_A = T_{MIN}$  to  $T_{MAX}$ ,  $V_{CC} = +15V$ ,  $V_{DD} = +5V$ ,  $V_{SS} = -15V$ ,  $V_{REFH} = +10V$ , and  $V_{REFL} = -10V$ , unless otherwise noted.

| PARAMETER  | CONDITIONS   | DAC7744E           |            |                    | DAC7744EB |     |     | DAC7744EC |                    |                    | UNITS          |
|--|--|--------------------|------------|--------------------|-----------|-----|-----|-----------|--------------------|--------------------|----------------|
|  |  | MIN                | TYP        | MAX                | MIN       | TYP | MAX | MIN       | TYP                | MAX                |                |
| <b>ACCURACY</b>  |  |                    |            |                    |           |     |     |           |                    |                    |                |
| Linearity Error<br>$T_{MIN}$ to $T_{MAX}$              | $T = 25^{\circ}C$                                  |                    |            | $\pm 3$<br>$\pm 4$ |           |     | *   |           |                    | $\pm 2$<br>$\pm 3$ | LSB<br>LSB     |
| Linearity Match  |  |                    | $\pm 4$    |                    |           | *   |     |           | $\pm 2$            |                    | LSB            |
| Differential Linearity Error<br>$T_{MIN}$ to $T_{MAX}$ | $T = 25^{\circ}C$                                  |                    |            | $\pm 3$<br>$\pm 3$ |           |     |     |           | $\pm 2$<br>$\pm 2$ |                    | LSB<br>LSB     |
| Monotonicity, $T_{MIN}$ to $T_{MAX}$                   |  | 14                 |            |                    | 15        |     |     | 16        |                    |                    | Bits           |
| Bipolar Zero Error                                     | $T = 25^{\circ}C$                                  |                    | $\pm 0.01$ | $\pm 0.025$        |           |     | *   |           |                    | *                  | % of FSR       |
| Bipolar Zero Error, $T_{MIN}$ to $T_{MAX}$             |  |                    |            | $\pm 0.05$         |           |     | *   |           |                    | *                  | % of FSR       |
| Full-Scale Error                                       | $T = 25^{\circ}C$                                  |                    |            | $\pm 0.025$        |           |     | *   |           |                    | *                  | % of FSR       |
| Full-Scale Error, $T_{MIN}$ to $T_{MAX}$               |  |                    |            | $\pm 0.05$         |           |     | *   |           |                    | *                  | % of FSR       |
| Bipolar Zero Matching                                  | Channel-to-Channel Matching                        |                    |            | $\pm 0.024$        |           |     | *   |           |                    | *                  | % of FSR       |
| Full-Scale Matching                                    | Channel-to-Channel Matching                        |                    |            | $\pm 0.024$        |           |     | *   |           |                    | *                  | % of FSR       |
| Power Supply Rejection Ratio (PSRR)                    | At Full Scale                                      |                    |            | 25                 |           |     | *   |           |                    | *                  | ppm/V          |
| <b>ANALOG OUTPUT</b>                                   |  |                    |            |                    |           |     |     |           |                    |                    |                |
| Voltage Output   |  | $V_{REFL}$         |            | $V_{REFH}$         | *         |     | *   | *         |                    | *                  | V              |
| Output Current   |  | $\pm 5$            |            |                    | *         |     | *   | *         |                    | *                  | mA             |
| Maximum Load Capacitance                               |  |                    | 500        |                    |           | *   |     | *         | *                  | *                  | pF             |
| Short-Circuit Current                                  |  |                    | $\pm 20$   |                    |           | *   |     | *         | *                  | *                  | mA             |
| Short-Circuit Duration                                 | To $V_{SS}$ , $V_{DD}$ or GND                      |                    | Indefinite |                    |           | *   |     | *         | *                  | *                  |                |
| <b>REFERENCE INPUT</b>                                 |  |                    |            |                    |           |     |     |           |                    |                    |                |
| Ref High Input Voltage Range                           |  | $V_{REFL} + 1.25$  |            | +10                | *         |     | *   | *         |                    | *                  | V              |
| Ref Low Input Voltage Range                            |  | -10                |            | $V_{REFH} - 1.25$  | *         |     | *   | *         |                    | *                  | V              |
| Ref High Input Current                                 |  | -0.3               |            | 2.6                |           | *   |     | *         | *                  | *                  | mA             |
| Ref Low Input Current                                  |  | -3.2               |            | -0.3               |           | *   |     | *         | *                  | *                  | mA             |
| <b>DYNAMIC PERFORMANCE</b>                             |  |                    |            |                    |           |     |     |           |                    |                    |                |
| Settling Time  | To $\pm 0.003\%$ , 20V Output Step<br>See Figure 5 |                    | 9          | 11                 |           | *   | *   |           | *                  | *                  | $\mu s$        |
| Channel-to-Channel Crosstalk                           |  |                    | 0.5        |                    |           | *   |     |           | *                  | *                  | LSB            |
| Digital Feedthrough                                    |  |                    | 2          |                    |           | *   |     |           | *                  | *                  | nV-s           |
| Output Noise Voltage                                   | $f = 10kHz$  |                    | 60         |                    |           | *   |     |           | *                  | *                  | $nV/\sqrt{Hz}$ |
| <b>DIGITAL INPUT</b>                                   |  |                    |            |                    |           |     |     |           |                    |                    |                |
| $V_{IH}$   |  | $0.7 \cdot V_{DD}$ |            | $V_{DD}$           | *         |     |     | *         |                    | *                  | V              |
| $V_{IL}$   |  | 0                  |            | $0.3 \cdot V_{DD}$ |           |     | *   |           |                    | *                  | V              |
| $I_{IH}$   |  |                    |            | $\pm 10$           |           |     | *   |           |                    | *                  | $\mu A$        |
| $I_{IL}$   |  |                    |            | $\pm 10$           |           |     | *   |           |                    | *                  | $\mu A$        |
| <b>DIGITAL OUTPUT</b>                                  |  |                    |            |                    |           |     |     |           |                    |                    |                |
| $V_{OH}$   | $I_{OH} = -0.8mA$                                  | 3.6                | 4.5        |                    | *         | *   |     | *         | *                  | *                  | V              |
| $V_{OL}$   | $I_{OL} = 1.6mA$                                   |                    | 0.3        | 0.4                |           | *   | *   |           | *                  | *                  | V              |
| <b>POWER SUPPLY</b>                                    |  |                    |            |                    |           |     |     |           |                    |                    |                |
| $V_{DD}$   |  | +4.75              | +5.0       | +5.25              | *         | *   | *   | *         | *                  | *                  | V              |
| $V_{CC}$   |  | +14.25             | +15.0      | +15.75             | *         | *   | *   | *         | *                  | *                  | V              |
| $V_{SS}$   |  | -14.25             | -15.0      | -15.75             | *         | *   | *   | *         | *                  | *                  | V              |
| $I_{DD}$   |  |                    | 50         |                    |           | *   |     | *         | *                  | *                  | $\mu A$        |
| $I_{CC}$   |  |                    | 6          |                    |           | *   |     | *         | *                  | *                  | mA             |
| $I_{SS}$   |  |                    | -5         |                    |           | *   |     | *         | *                  | *                  | mA             |
| Power  |  |                    | 170        | 200                |           | *   |     | *         | *                  | *                  | mW             |
| <b>TEMPERATURE RANGE</b>                               |  |                    |            |                    |           |     |     |           |                    |                    |                |
| Specified Performance                                  |  | -40                |            | +85                | *         |     | *   | *         |                    | *                  | $^{\circ}C$    |

\* Specifications same as grade to the left.

The information provided herein is believed to be reliable; however, BURR-BROWN assumes no responsibility for inaccuracies or omissions. BURR-BROWN assumes no responsibility for the use of this information, and all use of such information shall be entirely at the user's own risk. Prices and specifications are subject to change without notice. No patent rights or licenses to any of the circuits described herein are implied or granted to any third party. BURR-BROWN does not authorize or warrant any BURR-BROWN product for use in life support devices and/or systems.

# SPECIFICATIONS (Single Supply)

At  $T_A = T_{MIN}$  to  $T_{MAX}$ ,  $V_{CC} = +15V$ ,  $V_{DD} = +5V$ ,  $V_{SS} = GND$ ,  $V_{REFH} = +10V$ , and  $V_{REFL} = +50mV$ , unless otherwise noted.

| PARAMETER  | CONDITIONS  | DAC7744E           |            |                    | DAC7744EB |     |     | DAC7744EC |                    |                    | UNITS          |
|--|---|--------------------|------------|--------------------|-----------|-----|-----|-----------|--------------------|--------------------|----------------|
|  |   | MIN                | TYP        | MAX                | MIN       | TYP | MAX | MIN       | TYP                | MAX                |                |
| <b>ACCURACY</b>  |   |                    |            |                    |           |     |     |           |                    |                    |                |
| Linearity Error <sup>(1)</sup><br>$T_{MIN}$ to $T_{MAX}$ | $T = 25^\circ C$                                      |                    |            | $\pm 3$<br>$\pm 4$ |           |     | *   |           |                    | $\pm 2$<br>$\pm 3$ | LSB<br>LSB     |
| Linearity Match  |   |                    | $\pm 4$    |                    |           | *   |     |           | $\pm 2$            |                    | LSB            |
| Differential Linearity Error<br>$T_{MIN}$ to $T_{MAX}$   | $T = 25^\circ C$                                      |                    |            | $\pm 3$<br>$\pm 3$ |           |     |     |           | $\pm 2$<br>$\pm 2$ |                    | LSB<br>LSB     |
| Monotonicity, $T_{MIN}$ to $T_{MAX}$                     | $T = 25^\circ C$                                      | 14                 | $\pm 0.01$ | $\pm 0.025$        | 15        |     |     | 16        |                    | *                  | Bits           |
| Unipolar Zero  | $T = 25^\circ C$                                      |                    |            | $\pm 0.05$         |           |     | *   |           |                    | *                  | % of FSR       |
| Unipolar Zero Error, $T_{MIN}$ to $T_{MAX}$              |   |                    |            | $\pm 0.05$         |           |     | *   |           |                    | *                  | % of FSR       |
| Full-Scale Error   | $T = 25^\circ C$                                      |                    |            | $\pm 0.025$        |           |     | *   |           |                    | *                  | % of FSR       |
| Full-Scale Error, $T_{MIN}$ to $T_{MAX}$                 |   |                    |            | $\pm 0.05$         |           |     | *   |           |                    | *                  | % of FSR       |
| Unipolar Zero Matching                                   | Channel-to-Channel Matching                           |                    |            | $\pm 0.024$        |           |     | *   |           |                    | *                  | % of FSR       |
| Full-Scale Matching                                      | Channel-to-Channel Matching                           |                    |            | $\pm 0.024$        |           |     | *   |           |                    | *                  | % of FSR       |
| Power Supply Rejection Ratio (PSRR)                      | At Full Scale   |                    |            | 25                 |           |     | *   |           |                    | *                  | ppm/V          |
| <b>ANALOG OUTPUT</b>                                     |   |                    |            |                    |           |     |     |           |                    |                    |                |
| Voltage Output   | $V_{REFL} = 0V$ , $V_{SS} = 0V$<br>$R = 10k\Omega$    | 0                  |            | $V_{REFH}$         | *         |     | *   | *         |                    | *                  | V              |
| Output Current   |   | $\pm 5$            |            |                    | *         |     |     | *         |                    | *                  | mA             |
| Maximum Load Capacitance                                 |   |                    | 500        |                    |           | *   |     | *         | *                  | *                  | pF             |
| Short-Circuit Current                                    |   |                    | $\pm 20$   |                    |           | *   |     | *         | *                  | *                  | mA             |
| Short-Circuit Duration                                   | To $V_{SS}$ , $V_{CC}$ or GND                         |                    | Indefinite |                    |           | *   |     | *         | *                  | *                  |                |
| <b>REFERENCE INPUT</b>                                   |   |                    |            |                    |           |     |     |           |                    |                    |                |
| Ref High Input Voltage Range                             |   | $V_{REFL} + 1.25$  |            | +10                | *         |     | *   | *         |                    | *                  | V              |
| Ref Low Input Voltage Range                              |   | 0                  |            | $V_{REFH} - 1.25$  | *         |     | *   | *         |                    | *                  | V              |
| Ref High Input Current                                   |   | -0.3               |            | 1.0                |           | *   |     |           | *                  | *                  | mA             |
| Ref Low Input Current                                    |   | -1.5               |            | -0.3               |           | *   |     |           | *                  | *                  | mA             |
| <b>DYNAMIC PERFORMANCE</b>                               |   |                    |            |                    |           |     |     |           |                    |                    |                |
| Settling Time  | To $\pm 0.003\%$ , 10V<br>Output Step<br>See Figure 6 |                    | 8          | 10                 |           | *   | *   |           | *                  | *                  | $\mu s$        |
| Channel-to-Channel Crosstalk                             |   |                    | 0.5        |                    |           | *   |     |           | *                  | *                  | LSB            |
| Digital Feedthrough                                      |   |                    | 2          |                    |           | *   |     |           | *                  | *                  | nV-s           |
| Output Noise Voltage                                     | $f = 10kHz$   |                    | 60         |                    |           | *   |     |           | *                  | *                  | $nV/\sqrt{Hz}$ |
| <b>DIGITAL INPUT</b>                                     |   |                    |            |                    |           |     |     |           |                    |                    |                |
| $V_{IH}$   |   | $0.7 \cdot V_{DD}$ |            | $V_{DD}$           | *         |     |     | *         |                    | *                  | V              |
| $V_{IL}$   |   | 0                  |            | $0.3 \cdot V_{DD}$ |           |     | *   |           | *                  | *                  | V              |
| $I_{IH}$   |   |                    |            | $\pm 10$           |           |     | *   |           | *                  | *                  | $\mu A$        |
| $I_{IL}$   |   |                    |            | $\pm 10$           |           |     | *   |           | *                  | *                  | $\mu A$        |
| <b>DIGITAL OUTPUT</b>                                    |   |                    |            |                    |           |     |     |           |                    |                    |                |
| $V_{OH}$   | $I_{OH} = -0.8mA$                                     | 3.6                | 4.5        |                    | *         | *   |     | *         | *                  | *                  | V              |
| $V_{OL}$   | $I_{OL} = 1.6mA$                                      |                    | 0.3        | 0.4                |           | *   | *   |           | *                  | *                  | V              |
| <b>POWER SUPPLY</b>                                      |   |                    |            |                    |           |     |     |           |                    |                    |                |
| $V_{DD}$   |   | +4.75              | +5.0       | +5.25              | *         | *   | *   | *         | *                  | *                  | V              |
| $V_{CC}$   |   | +14.25             | +15.0      | +15.75             | *         | *   | *   | *         | *                  | *                  | V              |
| $V_{SS}$   |   |                    | 0          |                    |           | *   |     |           | *                  | *                  | V              |
| $I_{DD}$   |   |                    | 50         |                    |           | *   |     |           | *                  | *                  | $\mu A$        |
| $I_{CC}$   |   |                    | 3.5        |                    |           | *   |     |           | *                  | *                  | mA             |
| Power  |   |                    | 50         | 70                 |           | *   |     |           | *                  | *                  | mW             |
| <b>TEMPERATURE RANGE</b>                                 |   |                    |            |                    |           |     |     |           |                    |                    |                |
| Specified Performance                                    |   | -40                |            | +85                | *         |     | *   | *         |                    | *                  | $^\circ C$     |

\* Specifications same as grade to the left.

NOTE: (1) If  $V_{SS} = 0V$ , the specification applies at code 0021<sub>H</sub> and above, due to possible negative zero scale error.

## ABSOLUTE MAXIMUM RATINGS<sup>(1)</sup>

|   |                          |
|---|--------------------------|
| $V_{CC}$ to $V_{SS}$ .....              | -0.3V to +32V            |
| $V_{CC}$ to AGND .....                  | -0.3V to +16V            |
| $V_{SS}$ to AGND .....                  | +0.3V to -16V            |
| AGND to DGND .....                      | -0.3V to +0.3V           |
| $V_{REFH}$ to AGND .....                | -9V to +11V              |
| $V_{REFL}$ to AGND .....                | -11V to +9V              |
| $V_{DD}$ to GND .....                   | -0.3V to +6V             |
| $V_{REFH}$ to $V_{REFL}$ .....          | -1V to 22V               |
| Digital Input Voltage to GND .....      | -0.3V to $V_{DD} + 0.3V$ |
| Digital Output Voltage to GND .....     | -0.3V to $V_{DD} + 0.3V$ |
| Maximum Junction Temperature .....      | +150°C                   |
| Operating Temperature Range .....       | -40°C to +85°C           |
| Storage Temperature Range .....         | -65°C to +150°C          |
| Lead Temperature (soldering, 10s) ..... | +300°C                   |

NOTE: (1) Stresses above those listed under "Absolute Maximum Ratings" may cause permanent damage to the device. Exposure to absolute maximum conditions for extended periods may affect device reliability.



## ELECTROSTATIC DISCHARGE SENSITIVITY

This integrated circuit can be damaged by ESD. Burr-Brown recommends that all integrated circuits be handled with appropriate precautions. Failure to observe proper handling and installation procedures can cause damage.

ESD damage can range from subtle performance degradation to complete device failure. Precision integrated circuits may be more susceptible to damage because very small parametric changes could cause the device not to meet its published specifications.

## PACKAGE/ORDERING INFORMATION

| PRODUCT   | LINEARITY ERROR (LSB) | DIFFERENTIAL NONLINEARITY (LSB) | PACKAGE      | PACKAGE DRAWING NUMBER | SPECIFICATION TEMPERATURE RANGE | ORDERING NUMBER <sup>(1)</sup> | TRANSPORT MEDIA |
|-----------|-----------------------|---------------------------------|--------------|------------------------|---------------------------------|--------------------------------|-----------------|
| DAC7744E  | ±4                    | ±3                              | 48-Lead SSOP | 333                    | -40°C to +85°C                  | DAC7744E                       | Rails           |
| "         | "                     | "                               | "            | "                      | "                               | DAC7744E/1K                    | Tape and Reel   |
| DAC7744EB | ±4                    | ±2                              | 48-Lead SSOP | 333                    | -40°C to +85°C                  | DAC7744EB                      | Rails           |
| "         | "                     | "                               | "            | "                      | "                               | DAC7744EB/1K                   | Tape and Reel   |
| DAC7744EC | ±3                    | ±1                              | 48-Lead SSOP | 333                    | -40°C to +85°C                  | DAC7744EC                      | Rails           |
| "         | "                     | "                               | "            | "                      | "                               | DAC7744EC/1K                   | Tape and Reel   |

NOTE: (1) Models with a slash (/) are available only in Tape and Reel in the quantities indicated (e.g., /1K indicates 1000 devices per reel). Ordering 1000 pieces of "DAC7744E/1K" will get a single 1000-piece Tape and Reel.

## ESD PROTECTION CIRCUITS

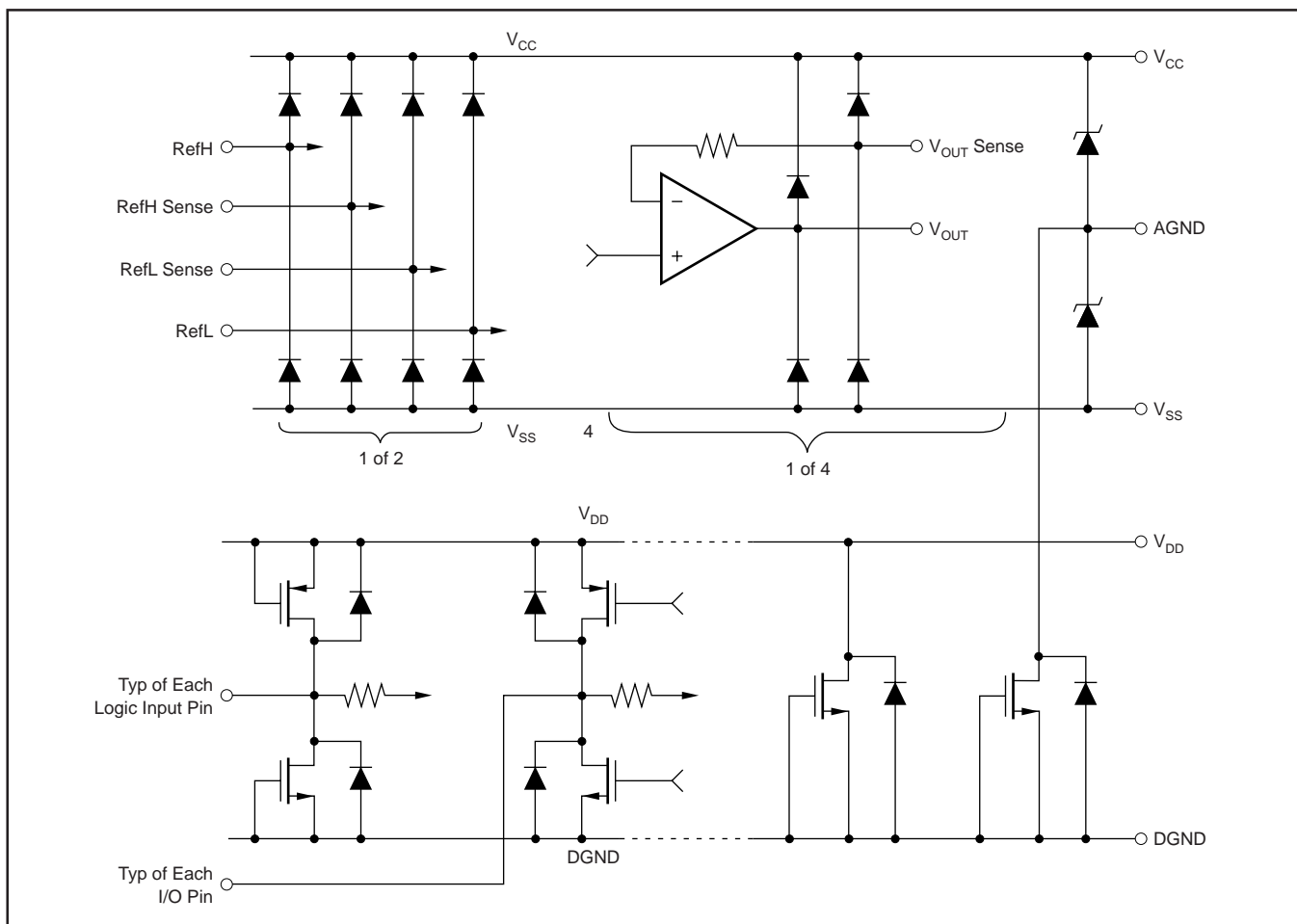

## PIN CONFIGURATION

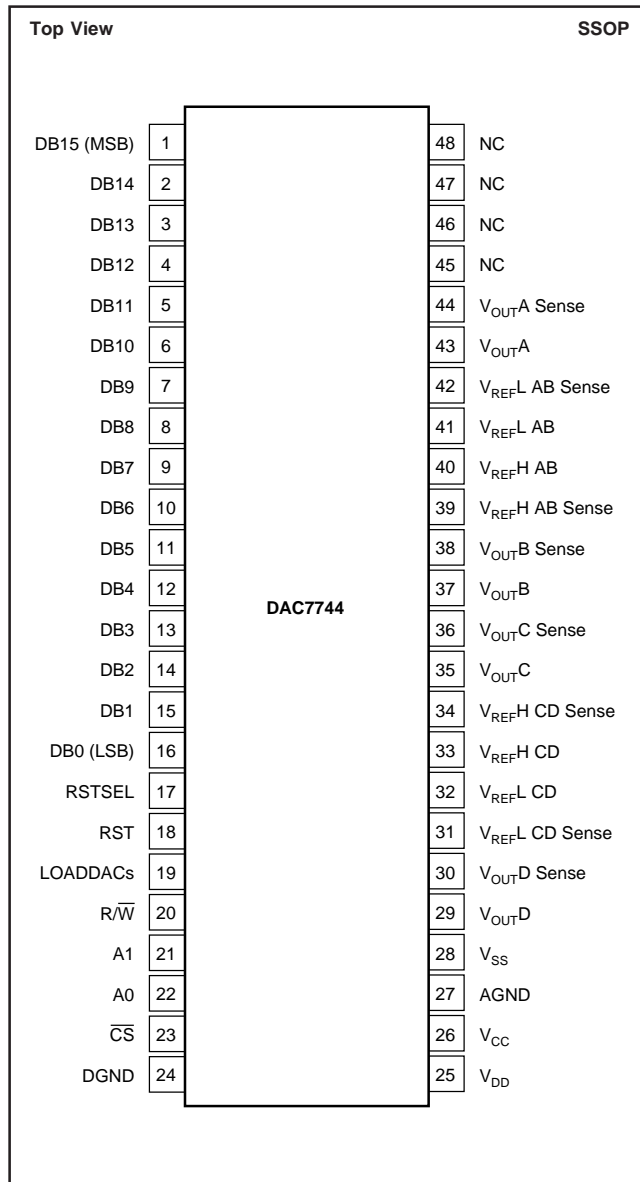

## PIN DESCRIPTIONS

| PIN | NAME                       | DESCRIPTION   |
|-----|----------------------------|---|
| 1   | DB15                       | Data Bit 15, MSB  |
| 2   | DB14                       | Data Bit 14   |
| 3   | DB13                       | Data Bit 13   |
| 4   | DB12                       | Data Bit 12   |
| 5   | DB11                       | Data Bit 11   |
| 6   | DB10                       | Data Bit 10   |
| 7   | DB9                        | Data Bit 9  |
| 8   | DB8                        | Data Bit 8  |
| 9   | DB7                        | Data Bit 7  |
| 10  | DB6                        | Data Bit 6  |
| 11  | DB5                        | Data Bit 5  |
| 12  | DB4                        | Data Bit 4  |
| 13  | DB3                        | Data Bit 3  |
| 14  | DB2                        | Data Bit 2  |
| 15  | DB1                        | Data Bit 1  |
| 16  | DB0                        | Data Bit 0, LSB   |
| 17  | RSTSEL                     | Reset Select. Determines the action of RST. If HIGH, a RST command will set the DAC registers to mid-scale. If LOW, a RST command will set the DAC registers to zero. |
| 18  | RST                        | Reset, Edge-Triggered. Depending on the state of RSTSEL, the DAC Input and Output registers are set to either mid-scale or zero.                                      |
| 19  | LOADDACs                   | DAC Output Registers Load Control. Rising edge triggered.   |
| 20  | R/W                        | Enabled by the CS, controls data read and write from the input register.  |
| 21  | A1                         | Enabled by the CS, in combination with A0 selects the Individual DAC Input Registers.   |
| 22  | A0                         | Enabled by the CS, in combination with A1 selects the individual DAC input registers.   |
| 23  | CS                         | Chip Select, Active LOW.  |
| 24  | DGND                       | Digital Ground  |
| 25  | V <sub>DD</sub>            | Positive Power Supply   |
| 26  | V <sub>CC</sub>            | Positive Power Supply   |
| 27  | AGND                       | Analog Ground   |
| 28  | V <sub>SS</sub>            | Negative Power Supply   |
| 29  | V <sub>OUTD</sub>          | DAC D Voltage Output  |
| 30  | V <sub>OUTD</sub> Sense    | DAC D's Output Amplifier Inverting Input. Used to close the feedback loop at the load.  |
| 31  | V <sub>REFL</sub> CD Sense | DAC C and D Reference Low Sense Input   |
| 32  | V <sub>REFL</sub> CD       | DAC C and D Reference Low Input   |
| 33  | V <sub>REFH</sub> CD       | DAC C and D Reference High Input  |
| 34  | V <sub>REFH</sub> CD Sense | DAC C and D Reference High Sense Input  |
| 35  | V <sub>OUTC</sub>          | DAC C Voltage Output  |
| 36  | V <sub>OUTC</sub> Sense    | DAC C's Output Amplifier Inverting Input. Used to close the feedback loop at the load.  |
| 37  | V <sub>OUTB</sub>          | DAC B Voltage Output  |
| 38  | V <sub>OUTB</sub> Sense    | DAC B's Output Amplifier Inverting Input. Used to close the feedback loop at the load.  |
| 39  | V <sub>REFH</sub> AB Sense | DAC A and B Reference High Sense Input  |
| 40  | V <sub>REFH</sub> AB       | DAC A and B Reference High Input  |
| 41  | V <sub>REFL</sub> AB       | DAC A and B Reference Low Input   |
| 42  | V <sub>REFL</sub> AB Sense | DAC A and B Reference Low Sense Input   |
| 43  | V <sub>OUTA</sub>          | DAC A Voltage Input   |
| 44  | V <sub>OUTA</sub> Sense    | DAC A's Output Amplifier Inverting Input. Used to close the feedback loop at the load.  |
| 45  | NC                         | No Connection   |
| 46  | NC                         | No Connection   |
| 47  | NC                         | No Connection   |
| 48  | NC                         | No Connection   |

# TYPICAL PERFORMANCE CURVES: $V_{SS} = 0V$

At  $T_A = +25^\circ C$ ,  $V_{DD} = +5V$ ,  $V_{CC} = +15V$ ,  $V_{SS} = 0$ ,  $V_{REFH} = +10V$ , and  $V_{REFL} = 0V$ , representative unit, unless otherwise specified.

## +25°C

LINEARITY ERROR AND  
DIFFERENTIAL LINEARITY ERROR vs CODE  
(DAC A, +25°C)

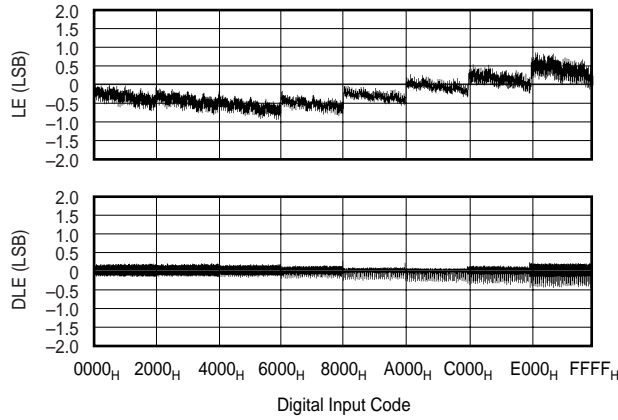

LINEARITY ERROR AND  
DIFFERENTIAL LINEARITY ERROR vs CODE  
(DAC B, +25°C)

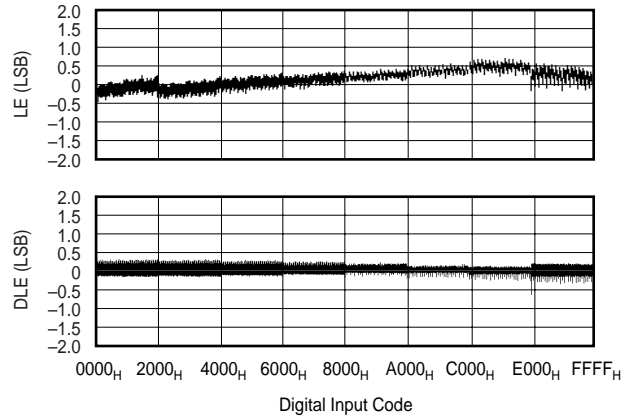

LINEARITY ERROR AND  
DIFFERENTIAL LINEARITY ERROR vs CODE  
(DAC C, +25°C)

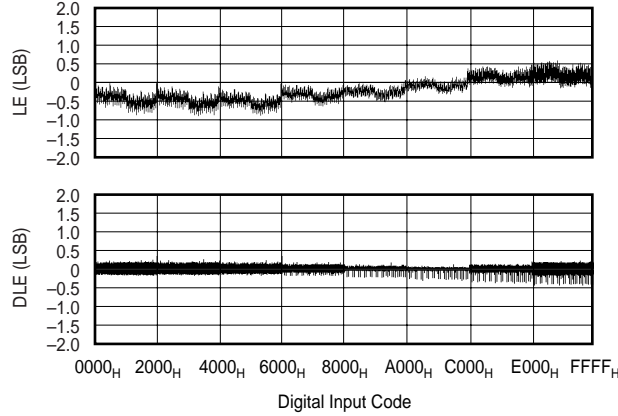

LINEARITY ERROR AND  
DIFFERENTIAL LINEARITY ERROR vs CODE  
(DAC D, +25°C)

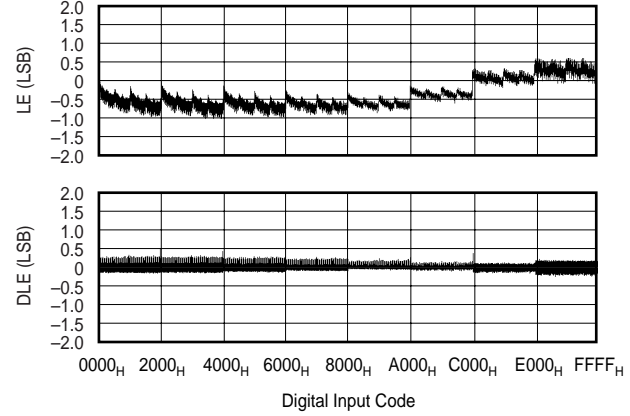

## +85°C

LINEARITY ERROR AND  
DIFFERENTIAL LINEARITY ERROR vs CODE  
(DAC A, +85°C)

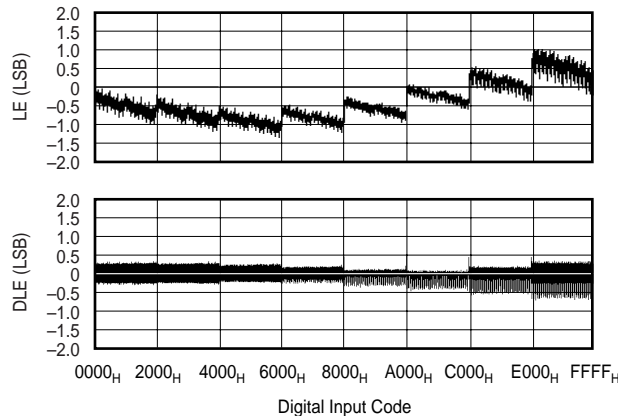

LINEARITY ERROR AND  
DIFFERENTIAL LINEARITY ERROR vs CODE  
(DAC B, +85°C)

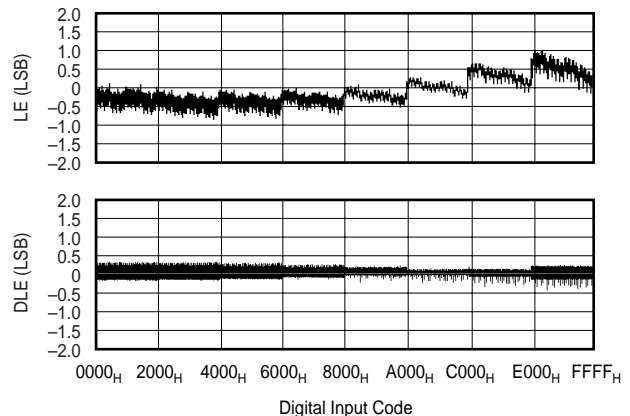

# TYPICAL PERFORMANCE CURVES: $V_{SS} = 0V$ (Cont.)

At  $T_A = +25^\circ C$ ,  $V_{DD} = +5V$ ,  $V_{CC} = +15V$ ,  $V_{SS} = 0$ ,  $V_{REFH} = +10V$ , and  $V_{REFL} = 0V$ , representative unit, unless otherwise specified.

## +85°C (cont.)

LINEARITY ERROR AND  
DIFFERENTIAL LINEARITY ERROR vs CODE  
(DAC C, +85°C)

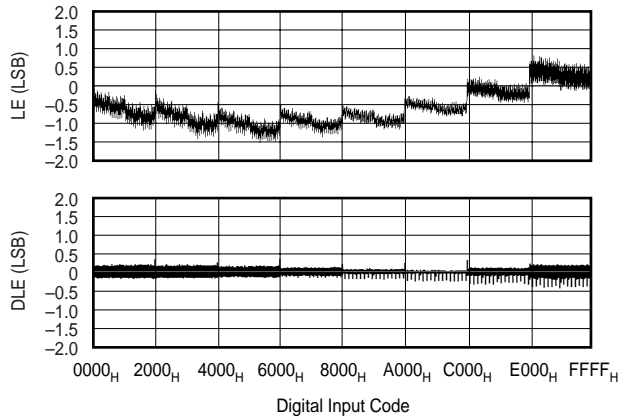

LINEARITY ERROR AND  
DIFFERENTIAL LINEARITY ERROR vs CODE  
(DAC D, +85°C)

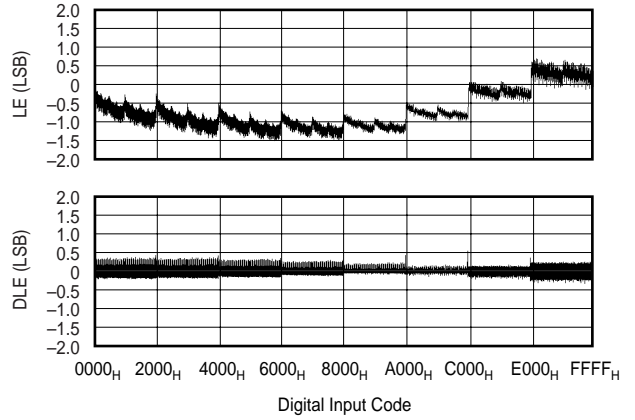

## -40°C

LINEARITY ERROR AND  
DIFFERENTIAL LINEARITY ERROR vs CODE  
(DAC A, -40°C)

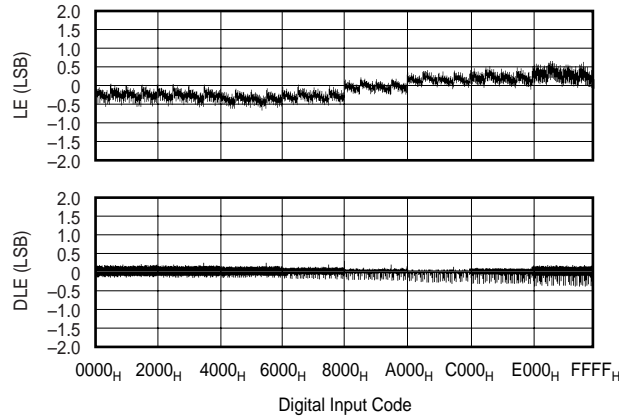

LINEARITY ERROR AND  
DIFFERENTIAL LINEARITY ERROR vs CODE  
(DAC B, -40°C)

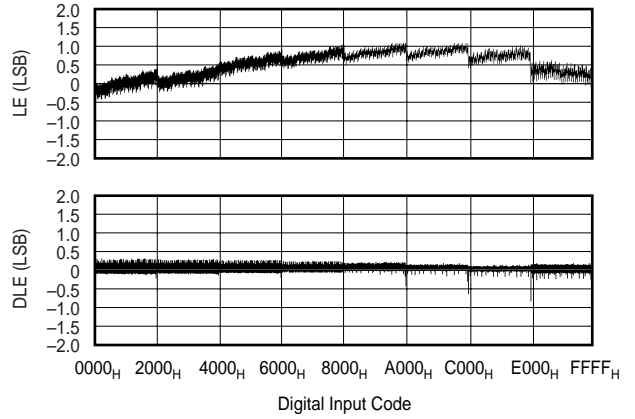

LINEARITY ERROR AND  
DIFFERENTIAL LINEARITY ERROR vs CODE  
(DAC C, -40°C)

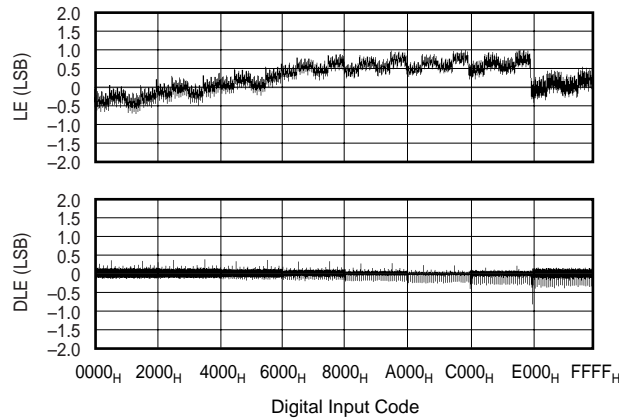

LINEARITY ERROR AND  
DIFFERENTIAL LINEARITY ERROR vs CODE  
(DAC D, -40°C)

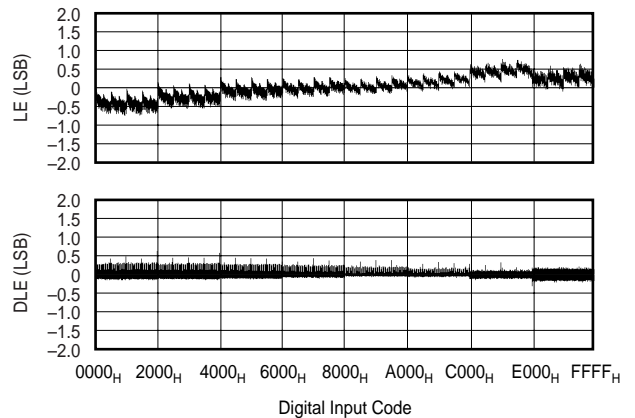

# TYPICAL PERFORMANCE CURVES: $V_{SS} = 0V$ (Cont.)

At  $T_A = +25^\circ C$ ,  $V_{DD} = +5V$ ,  $V_{CC} = +15V$ ,  $V_{SS} = 0$ ,  $V_{REFH} = +10V$ , and  $V_{REFL} = 0V$ , representative unit, unless otherwise specified.

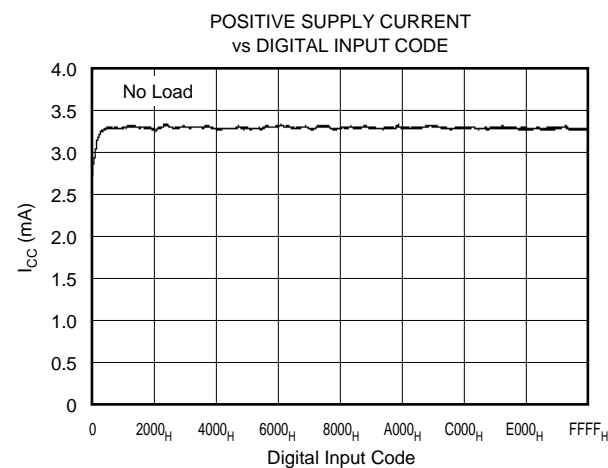
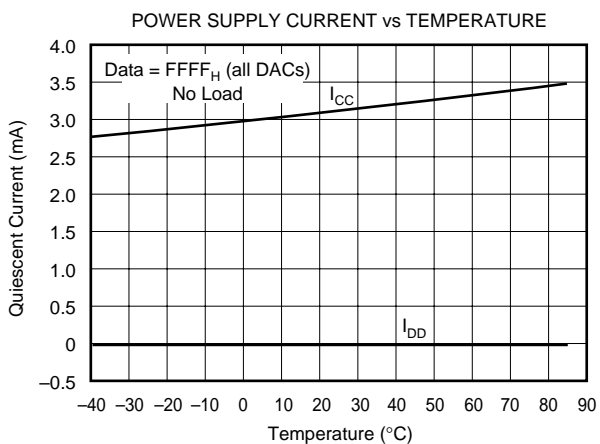
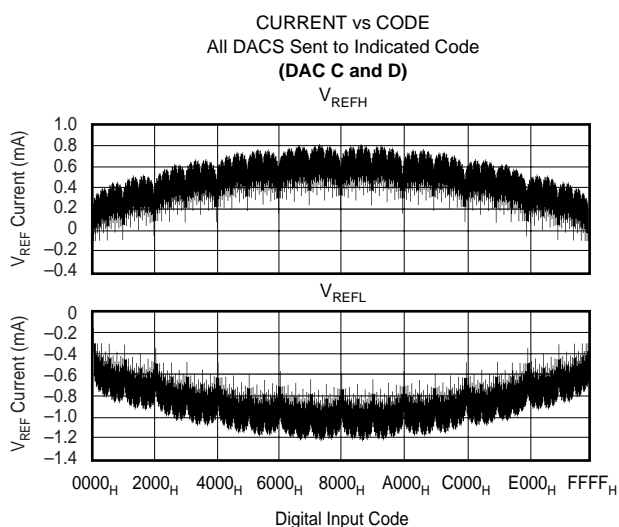
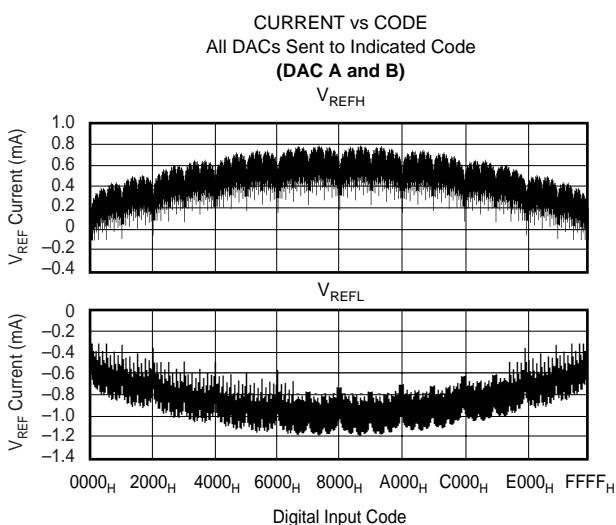
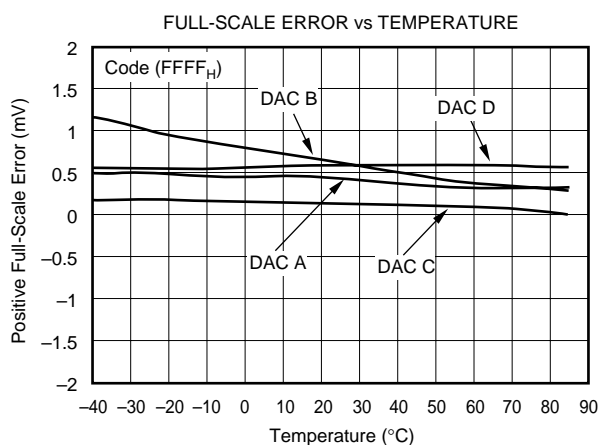
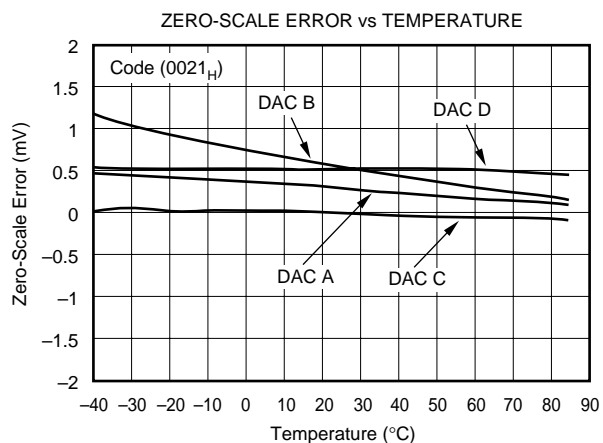



# TYPICAL PERFORMANCE CURVES: $V_{SS} = 0V$ (Cont.)

At  $T_A = +25^\circ C$ ,  $V_{DD} = +5V$ ,  $V_{CC} = +15V$ ,  $V_{SS} = 0$ ,  $V_{REFH} = +10V$ , and  $V_{REFL} = 0V$ , representative unit, unless otherwise specified.

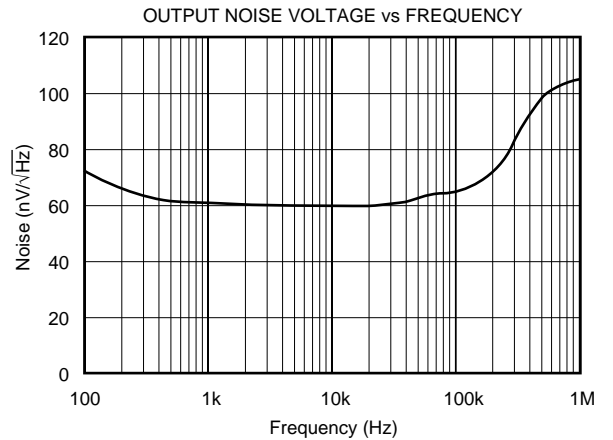
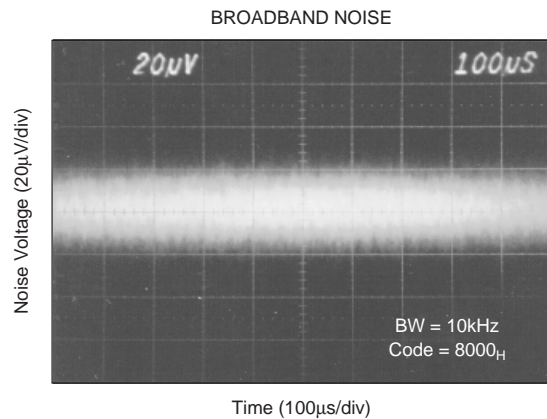
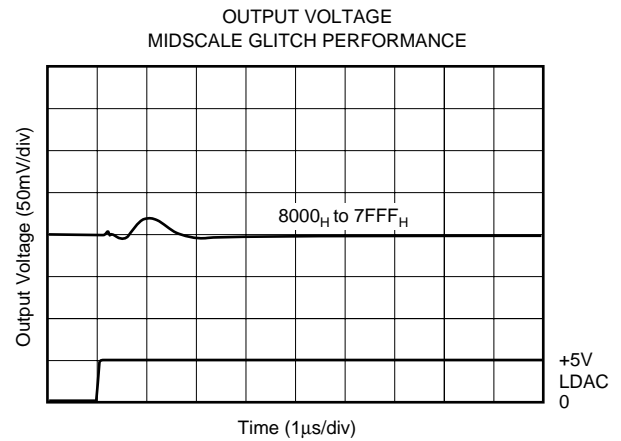
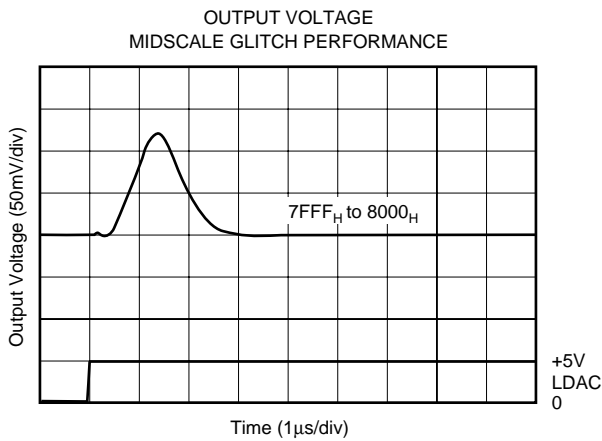
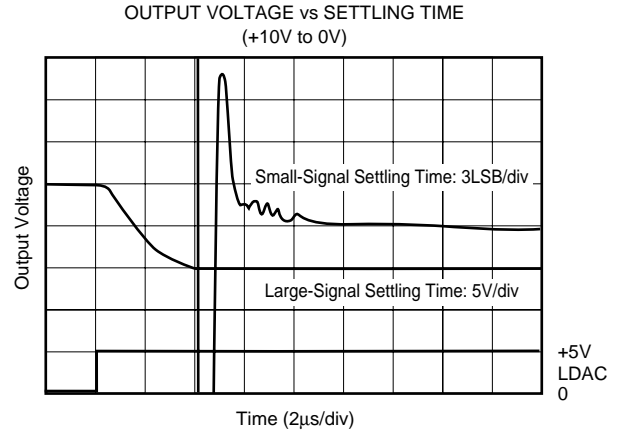
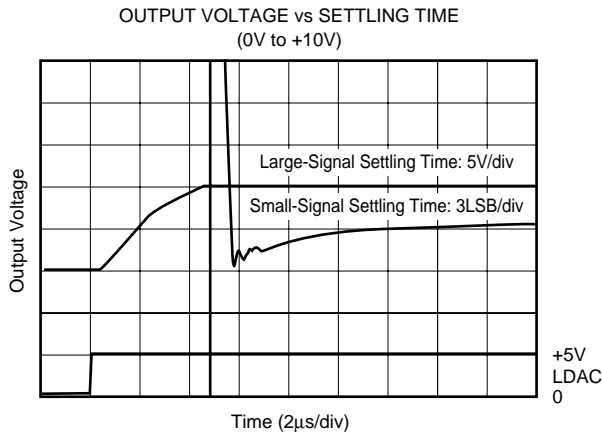

# TYPICAL PERFORMANCE CURVES: $V_{SS} = 0V$ (Cont.)

At  $T_A = +25^\circ C$ ,  $V_{DD} = +5V$ ,  $V_{CC} = +15V$ ,  $V_{SS} = 0$ ,  $V_{REFH} = +10V$ , and  $V_{REFL} = 0V$ , representative unit, unless otherwise specified.

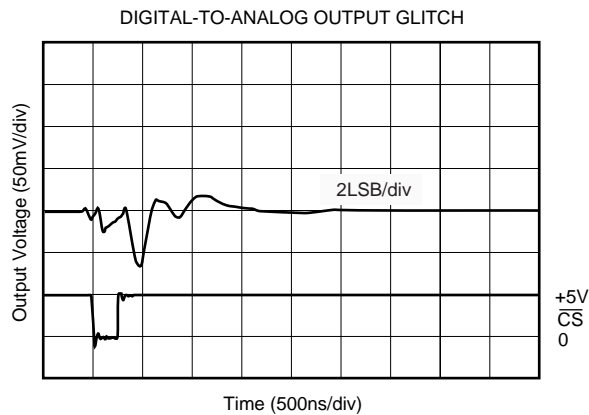
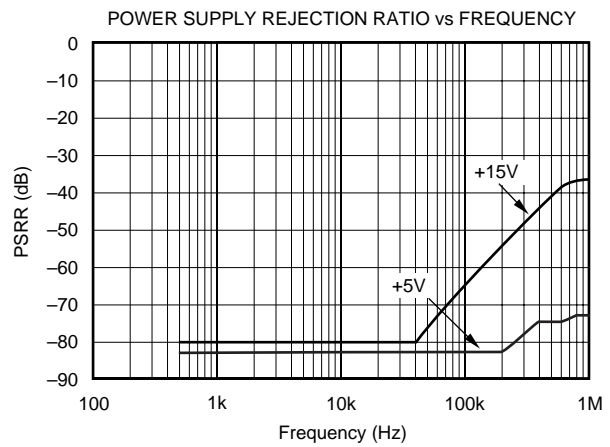
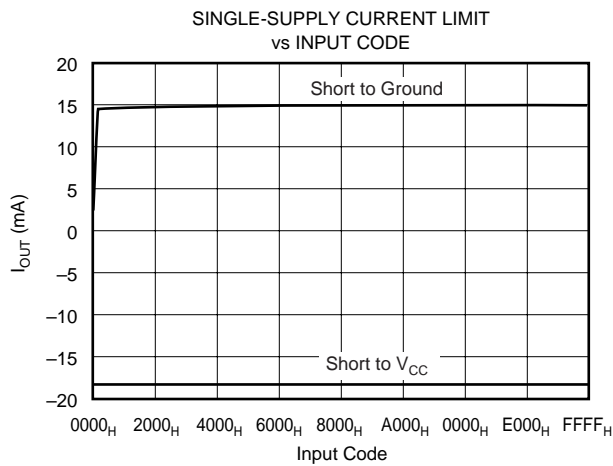
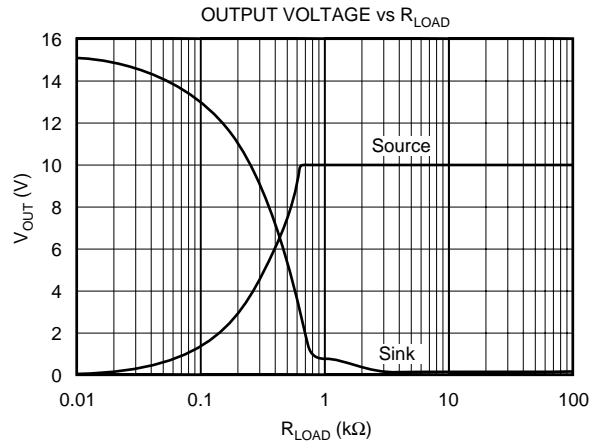
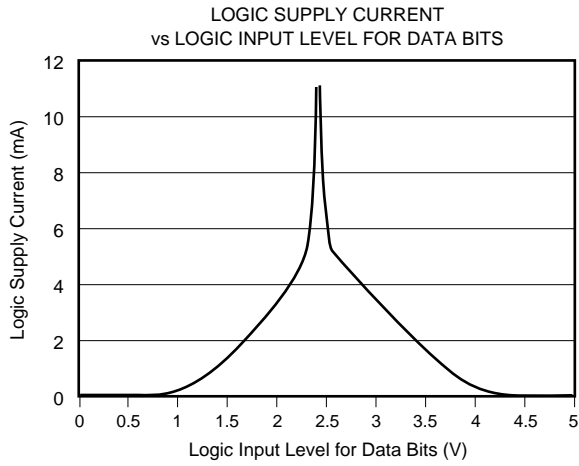

# TYPICAL PERFORMANCE CURVES: $V_{SS} = -15V$

At  $T_A = +25^\circ C$ ,  $V_{DD} = +5V$ ,  $V_{CC} = +15V$ ,  $V_{SS} = -15V$ ,  $V_{REFH} = +10V$ , and  $V_{REFL} = -10V$ , representative unit, unless otherwise specified.

## +25°C

LINEARITY ERROR AND  
DIFFERENTIAL LINEARITY ERROR vs CODE  
(DAC A, +25°C)

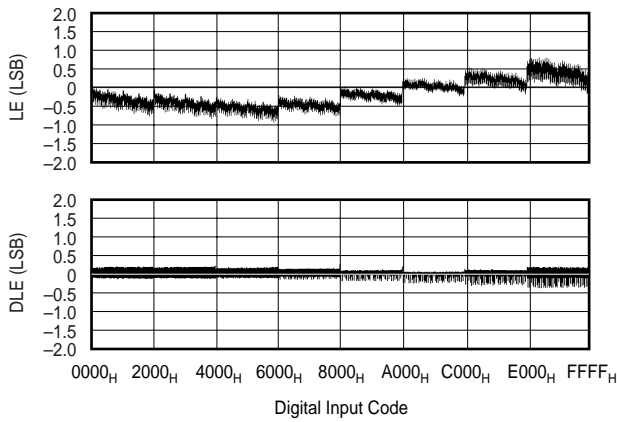

LINEARITY ERROR AND  
DIFFERENTIAL LINEARITY ERROR vs CODE  
(DAC B, +25°C)

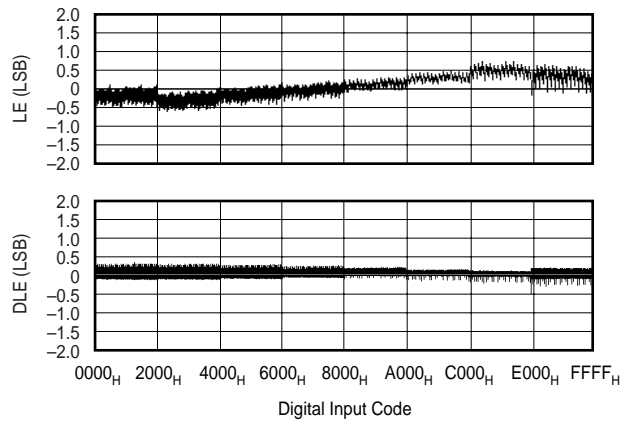

LINEARITY ERROR AND  
DIFFERENTIAL LINEARITY ERROR vs CODE  
(DAC C, +25°C)

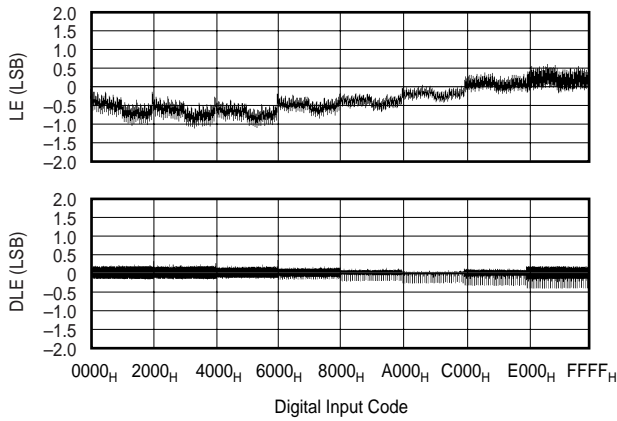

LINEARITY ERROR AND  
DIFFERENTIAL LINEARITY ERROR vs CODE  
(DAC D, +25°C)

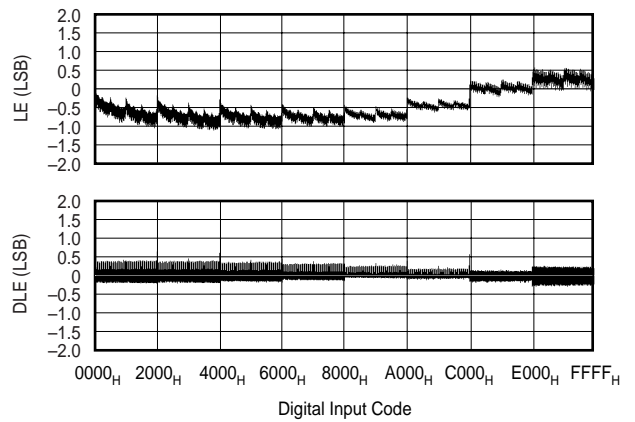

## +85°C

LINEARITY ERROR AND  
DIFFERENTIAL LINEARITY ERROR vs CODE  
(DAC A, +85°C)

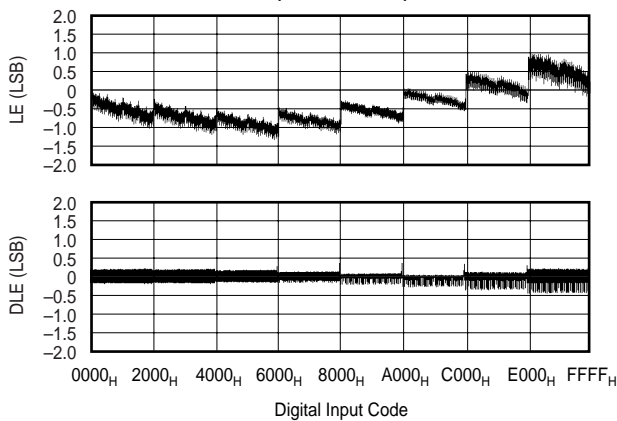

LINEARITY ERROR AND  
DIFFERENTIAL LINEARITY ERROR vs CODE  
(DAC B, +85°C)

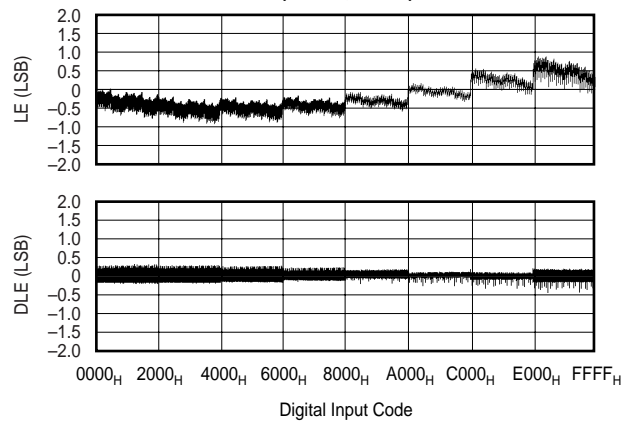

# TYPICAL PERFORMANCE CURVES: $V_{SS} = -15V$ (Cont.)

At  $T_A = +25^\circ C$ ,  $V_{DD} = +5V$ ,  $V_{CC} = +15V$ ,  $V_{SS} = -15V$ ,  $V_{REFH} = +10V$ , and  $V_{REFL} = -10V$ , representative unit, unless otherwise specified.

## +85°C (cont.)

LINEARITY ERROR AND  
DIFFERENTIAL LINEARITY ERROR vs CODE  
(DAC C, +85°C)

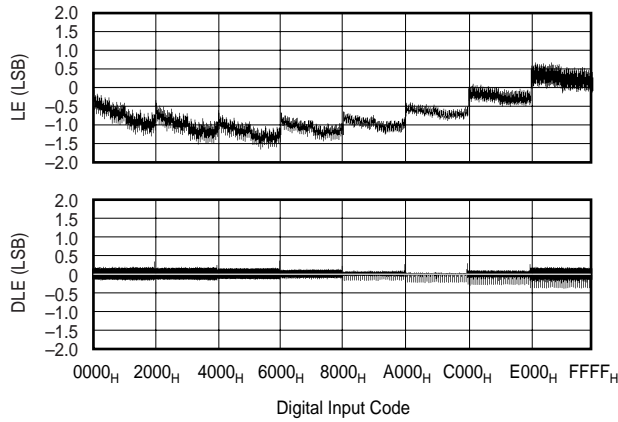

LINEARITY ERROR AND  
DIFFERENTIAL LINEARITY ERROR vs CODE  
(DAC D, +85°C)

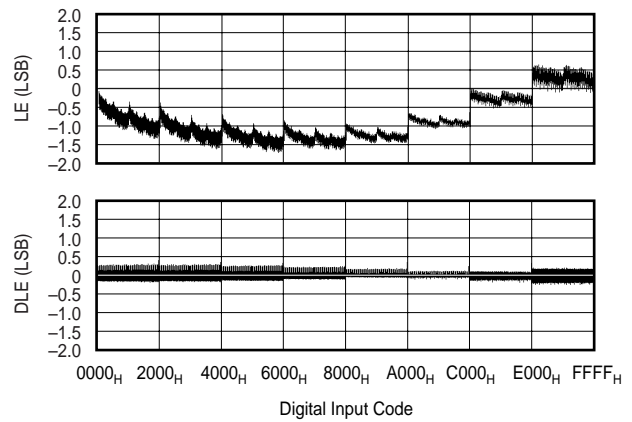

## -40°C

LINEARITY ERROR AND  
DIFFERENTIAL LINEARITY ERROR vs CODE  
(DAC A, -40°C)

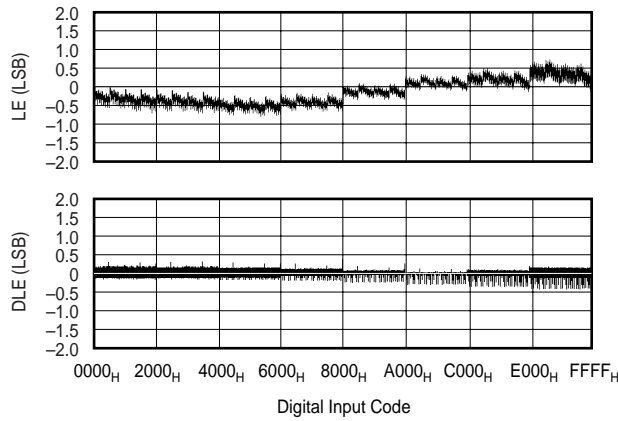

LINEARITY ERROR AND  
DIFFERENTIAL LINEARITY ERROR vs CODE  
(DAC B, -40°C)

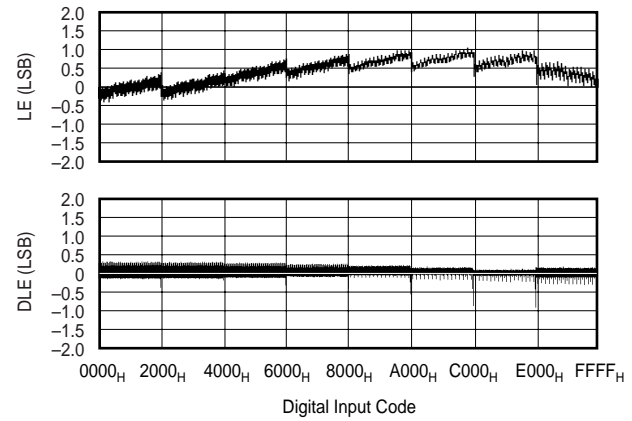

LINEARITY ERROR AND  
DIFFERENTIAL LINEARITY ERROR vs CODE  
(DAC C, -40°C)

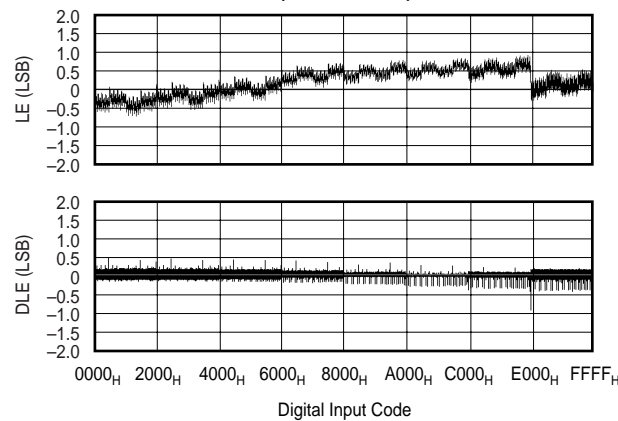

LINEARITY ERROR AND  
DIFFERENTIAL LINEARITY ERROR vs CODE  
(DAC D, -40°C)

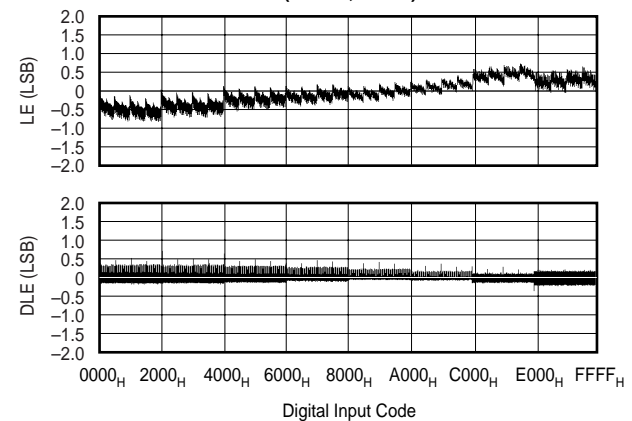

# TYPICAL PERFORMANCE CURVES: $V_{SS} = -15V$ (Cont.)

At  $T_A = +25^\circ C$ ,  $V_{DD} = +5V$ ,  $V_{CC} = +15V$ ,  $V_{SS} = -15V$ ,  $V_{REFH} = +10V$ , and  $V_{REFL} = -10V$ , representative unit, unless otherwise specified.

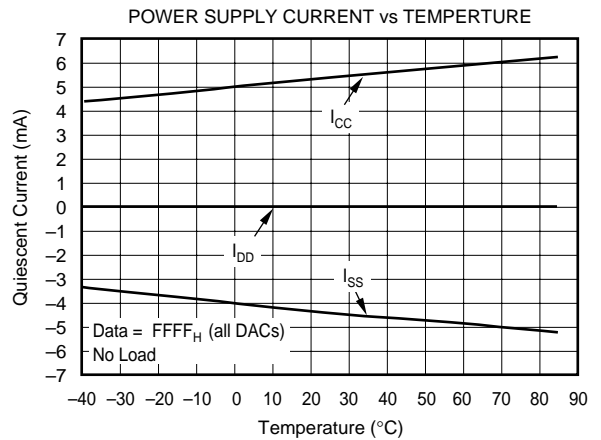
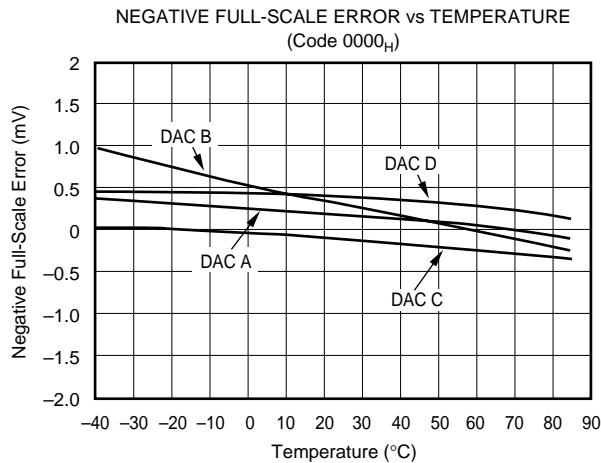
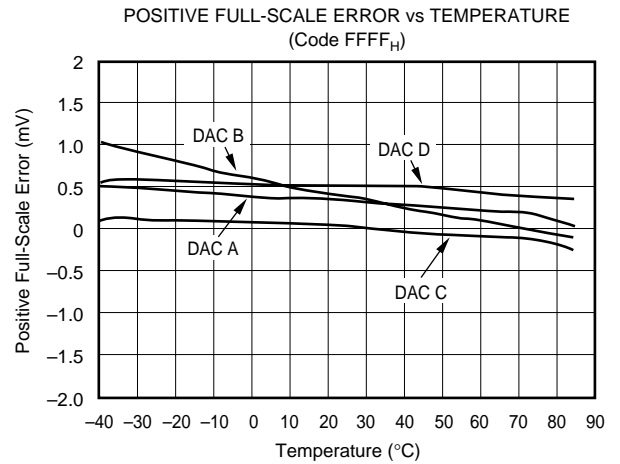
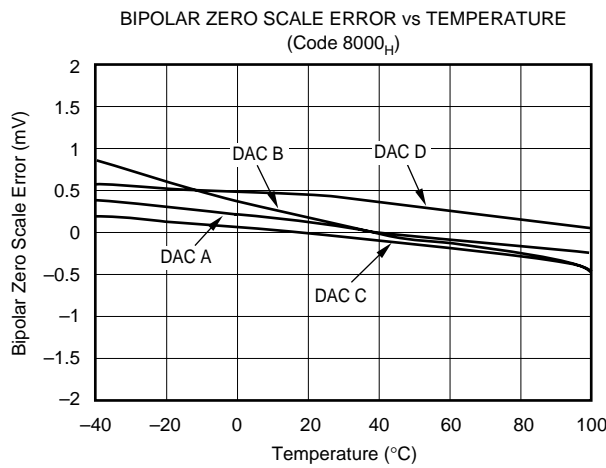
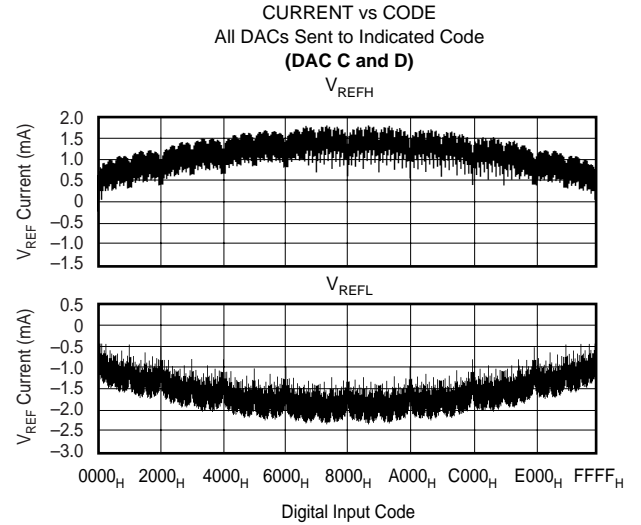
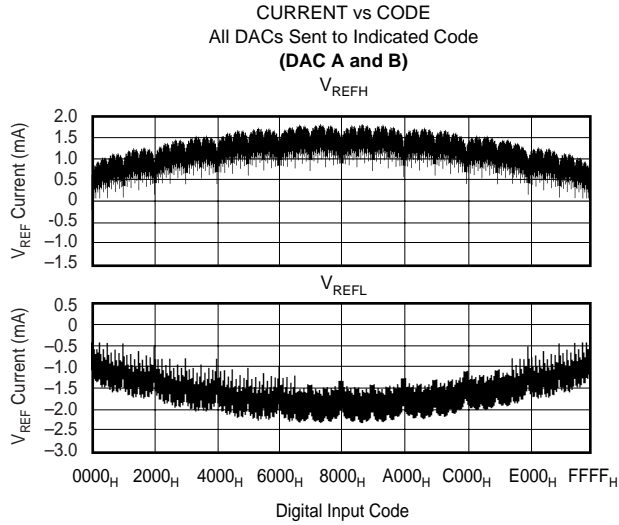

# TYPICAL PERFORMANCE CURVES: $V_{SS} = -15V$ (Cont.)

At  $T_A = +25^\circ C$ ,  $V_{DD} = +5V$ ,  $V_{CC} = +15V$ ,  $V_{SS} = -15V$ ,  $V_{REFH} = +10V$ , and  $V_{REFL} = -10V$ , representative unit, unless otherwise specified.

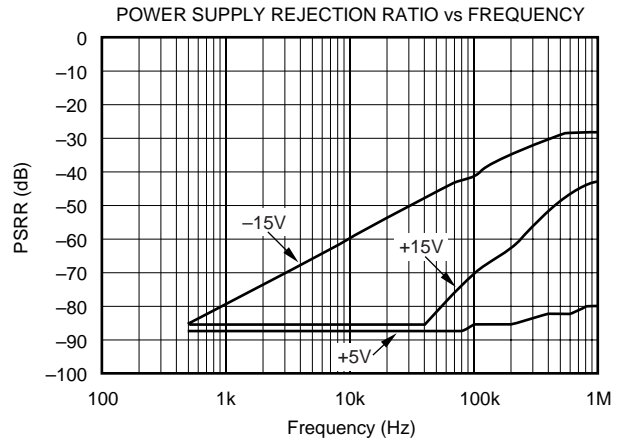
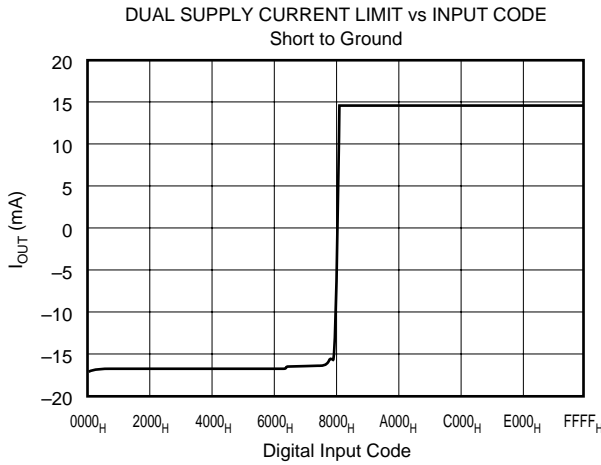
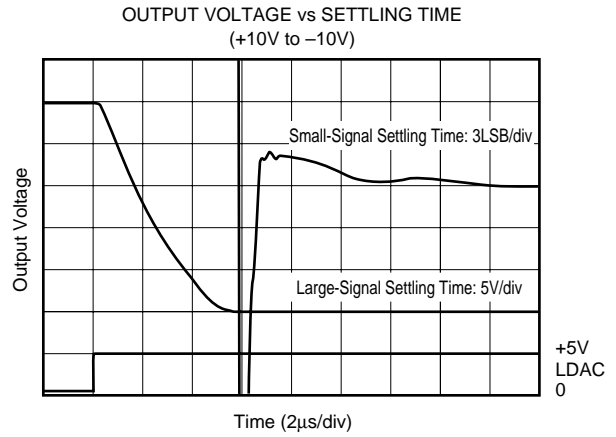
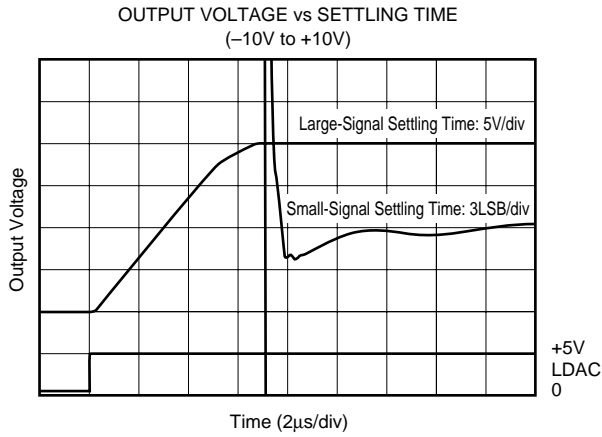
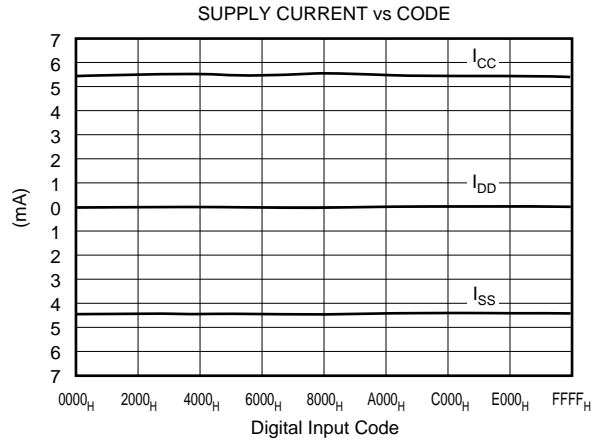
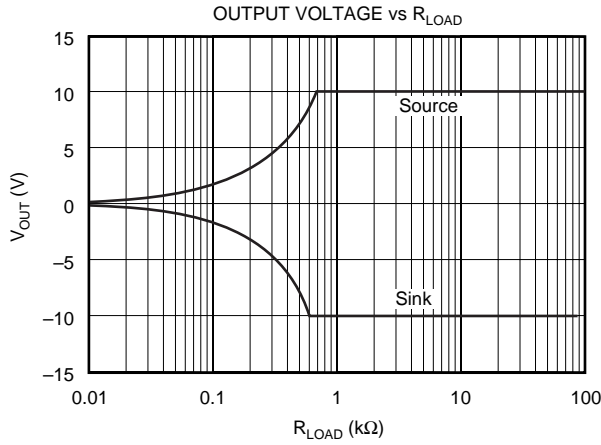

# TYPICAL PERFORMANCE CURVES: $V_{SS} = -15V$ (Cont.)

At  $T_A = +25^\circ C$ ,  $V_{DD} = +5V$ ,  $V_{CC} = +15V$ ,  $V_{SS} = -15V$ ,  $V_{REFH} = +10V$ , and  $V_{REFL} = -10V$ , representative unit, unless otherwise specified.

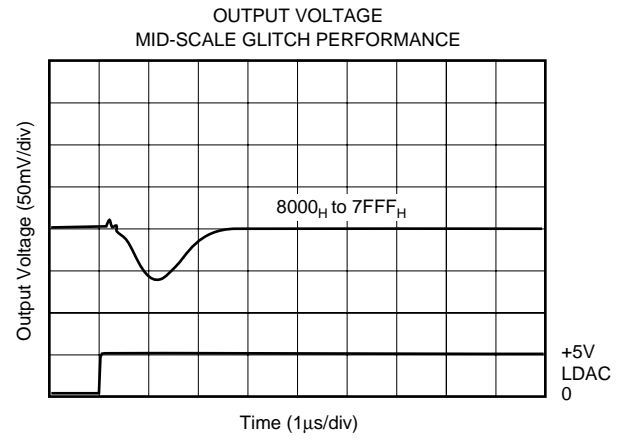
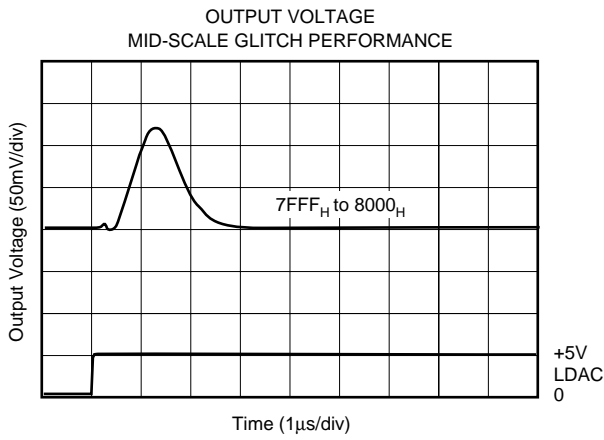

# THEORY OF OPERATION

The DAC7744 is a quad voltage output, 16-bit digital-to-analog converter (DAC). The architecture is an R-2R ladder configuration with the three MSB's segmented followed by an operational amplifier that serves as a buffer. Each DAC has its own R-2R ladder network, segmented MSBs and output op amp (see Figure 1). The minimum voltage output (zero scale) and maximum voltage output (full scale) are set

by the external voltage references ( $V_{REFL}$  and  $V_{REFH}$ , respectively). The digital input is a 16-bit parallel word and the DAC input registers offer a readback capability. The converters can be powered from either a single +15V supply or a dual  $\pm 15V$  supply. The device offers a reset function which immediately sets all DAC output voltages and DAC registers to mid-scale code  $8000_H$  or to zero scale, code  $0000_H$ . See Figures 2 and 3 for the basic operation of the DAC7744.

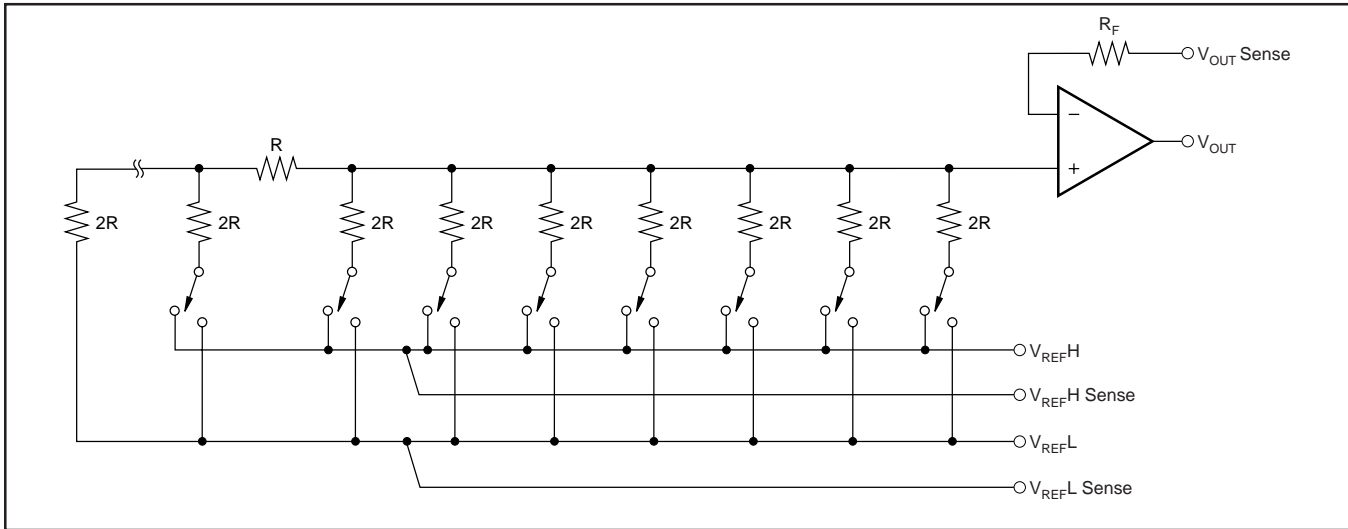

FIGURE 1. DAC7744 Architecture.

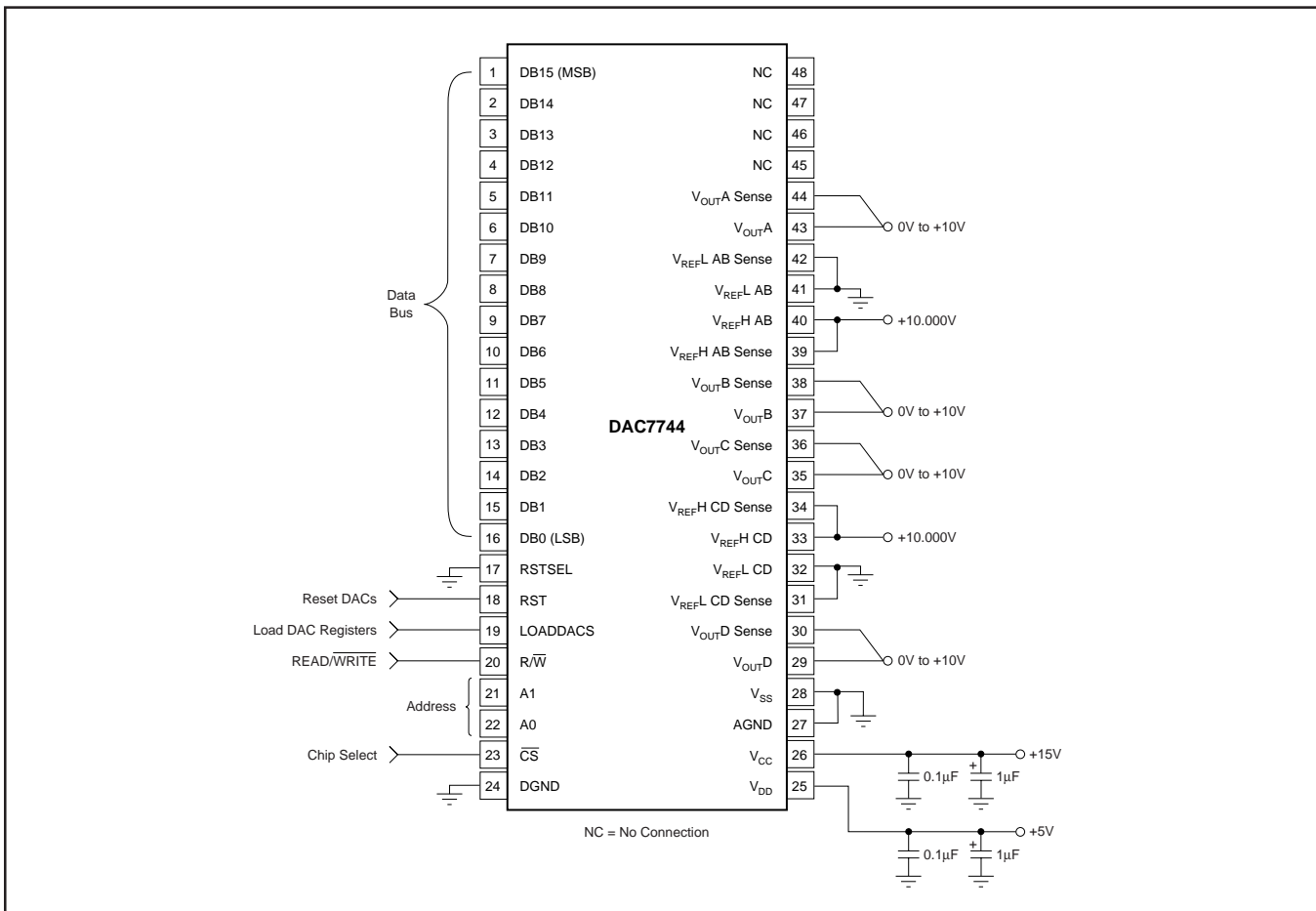

FIGURE 2. Basic Single-Supply Operation of the DAC7744.



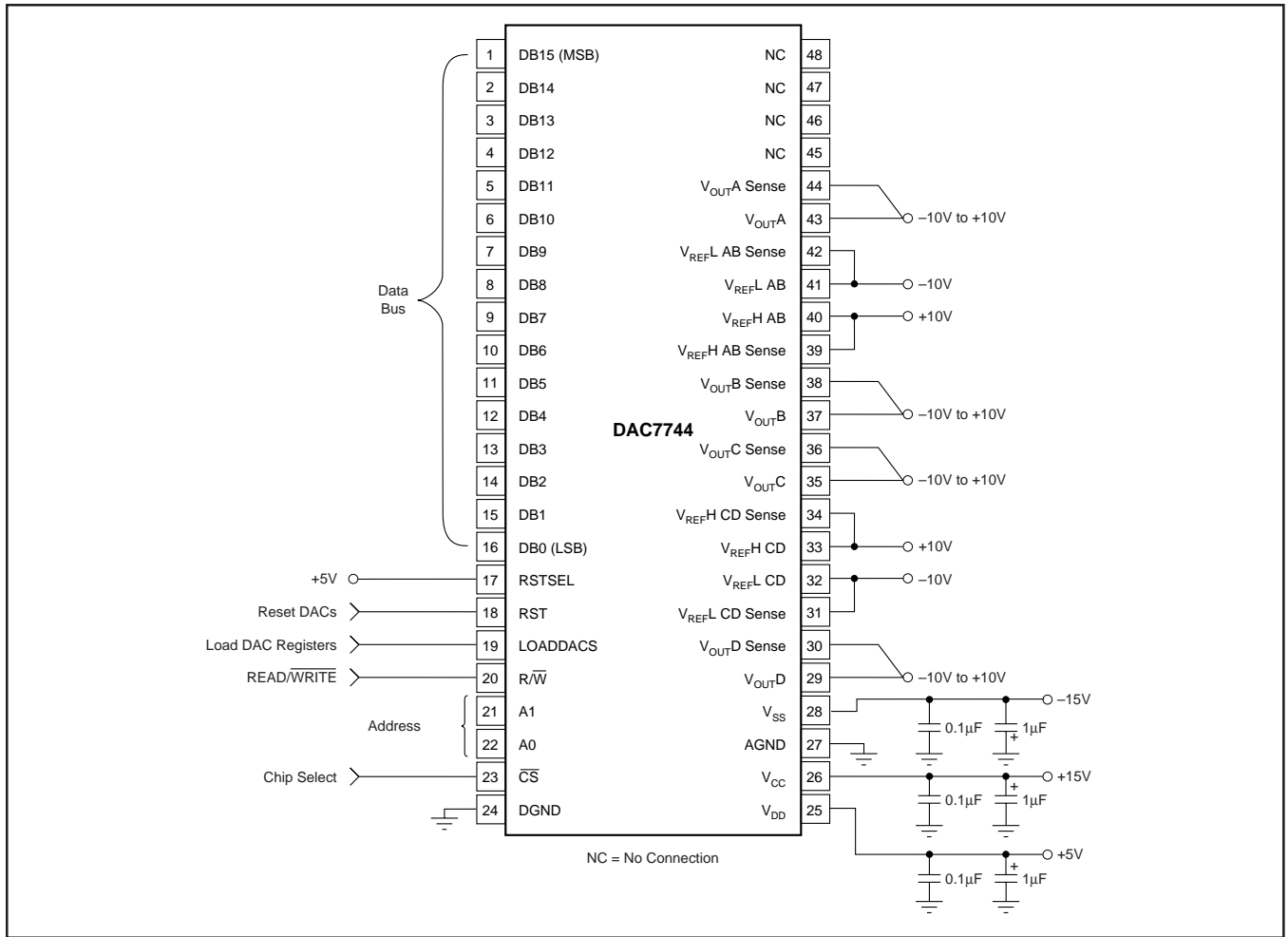

FIGURE 3. Basic Dual-Supply Operation of the DAC7744.

### ANALOG OUTPUTS

When  $V_{SS} = -15V$  (dual supply operation), the output amplifier can swing to within 4V of the supply rails, guaranteed over the  $-40^{\circ}C$  to  $+85^{\circ}C$  temperature range. With  $V_{SS} = 0V$  (single-supply operation), and with  $R_{LOAD}$  also connected to ground, the output can swing to ground. Care must also be taken when measuring the zero-scale error when  $V_{SS} = 0V$ . Since the output voltage cannot swing below ground, the output voltage may not change for the first few digital input codes (0000<sub>H</sub>, 0001<sub>H</sub>, 0002<sub>H</sub>, etc.), if the output amplifier has a negative offset. At the negative limit of  $-5mV$ , the first specified output starts at code 0021<sub>H</sub>.

Due to the high accuracy of these D/A converters, system design problems such as grounding and contact resistance become very important. A 16-bit converter with a 10V full-scale range has a 1LSB value of  $152\mu V$ . With a load current of 1mA, series wiring and connector resistance of only  $150m\Omega$  ( $R_{W2}$ ) will cause a voltage drop of  $150\mu V$ , as shown in Figure 4. To understand what this means in terms of a system layout, the resistivity of a typical 1 ounce copper-clad printed circuit board is  $1/2 m\Omega$  per square. For a 1mA load, a 20 milli-inch wide printed circuit conductor 6 inches long will result in a voltage drop of  $150\mu V$ .

The DAC7744 offers a force and sense output configuration for the high open-loop gain output amplifiers. This feature

allows the loop around the output amplifier to be closed at the load, thus ensuring an accurate output voltage, as shown in Figure 4.

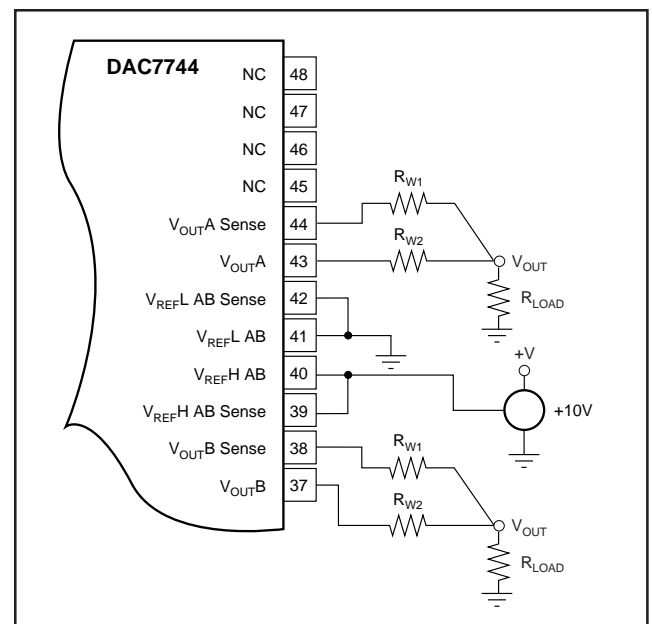

FIGURE 4. Analog Output Closed-Loop Configuration (1/2 DAC7744).  $R_W$  represents wiring resistances.

## REFERENCE INPUTS

The reference inputs,  $V_{REFL}$  and  $V_{REFH}$ , can be any voltage between  $V_{SS} + 4V$  and  $V_{CC} - 4V$ , provided that  $V_{REFH}$  is at least 1.25V greater than  $V_{REFL}$ . The minimum output of each DAC is equal to  $V_{REFL}$  plus a small offset voltage (essentially, the offset of the output op amp). The maximum output is equal to  $V_{REFH}$  plus a similar offset voltage. Note that  $V_{SS}$  (the negative power supply) must either be connected to ground or must be in the range of  $-14.25V$  to  $-15.75V$ . The voltage on  $V_{SS}$  sets several bias points within the converter. If  $V_{SS}$  is not in one of these two configurations, the bias values may be in error and proper operation of the device is not guaranteed.

The current into the  $V_{REFH}$  input and out of  $V_{REFL}$  depends on the DAC output voltages and can vary from a few

microamps to approximately 2.0mA. The reference input appears as a varying load to the reference. If the reference can sink or source the required current, a reference buffer is not required. The DAC7744 features a reference drive and sense connection such that the internal errors caused by the changing reference current and the circuit impedances can be minimized. Figures 5 through 12 show different reference configurations and the effect on the linearity and differential linearity.

The analog supplies (or the analog supplies and the reference power supplies) have to come up first. If the power supplies for the reference come up first, then the  $V_{CC}$  and  $V_{SS}$  supplies will be “powered from the reference via the ESD protection diode”, see page 4.

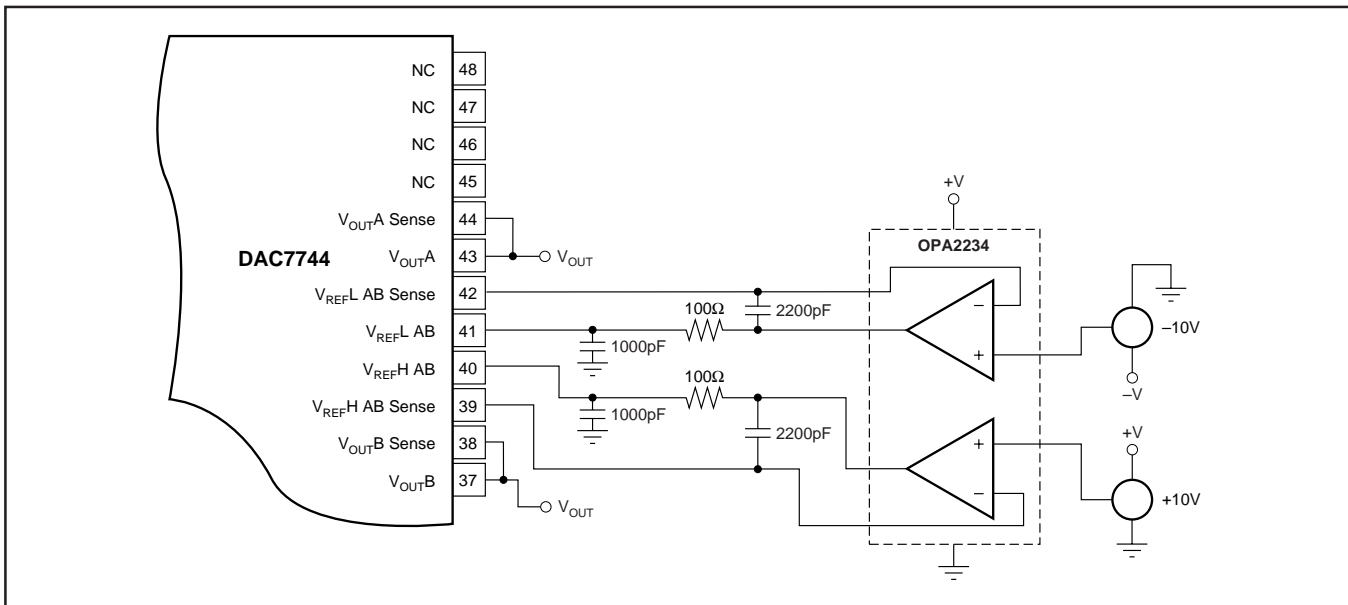

FIGURE 5. Dual Supply Configuration-Buffered References, used for Dual Supply Performance Curves (1/2 DAC7744).

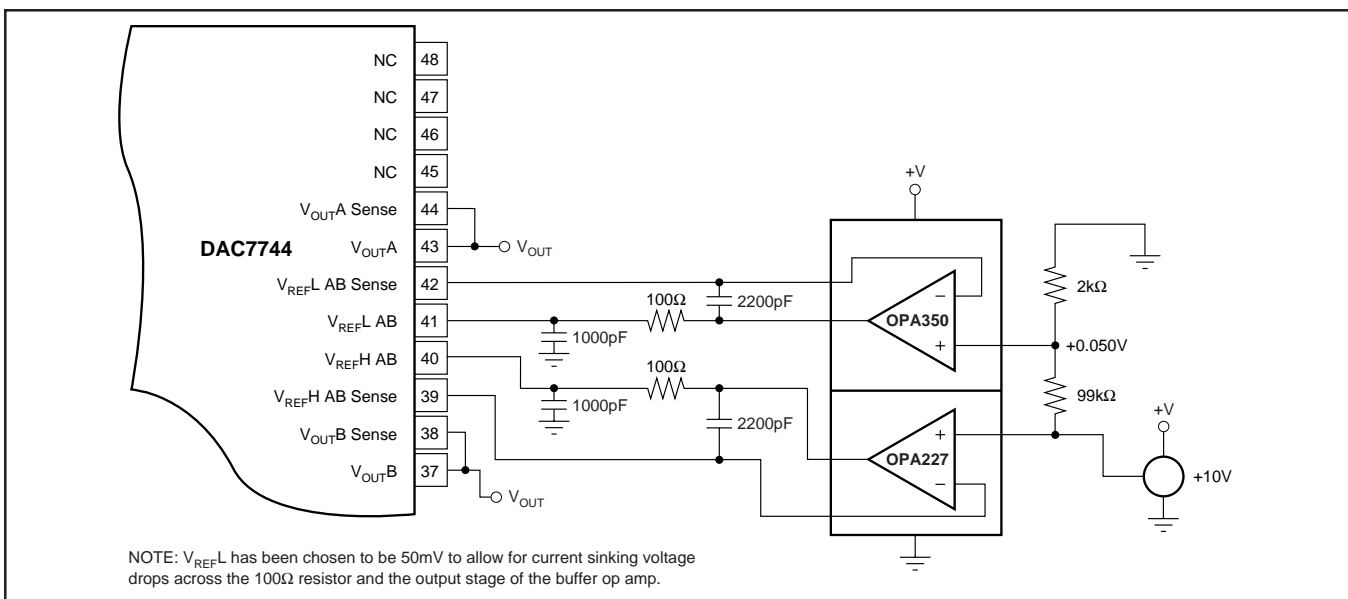

FIGURE 6. Single-Supply Buffered Reference with a Reference Low of 50mV Used for Single-Supply Performance Curves (1/2 DAC7744).

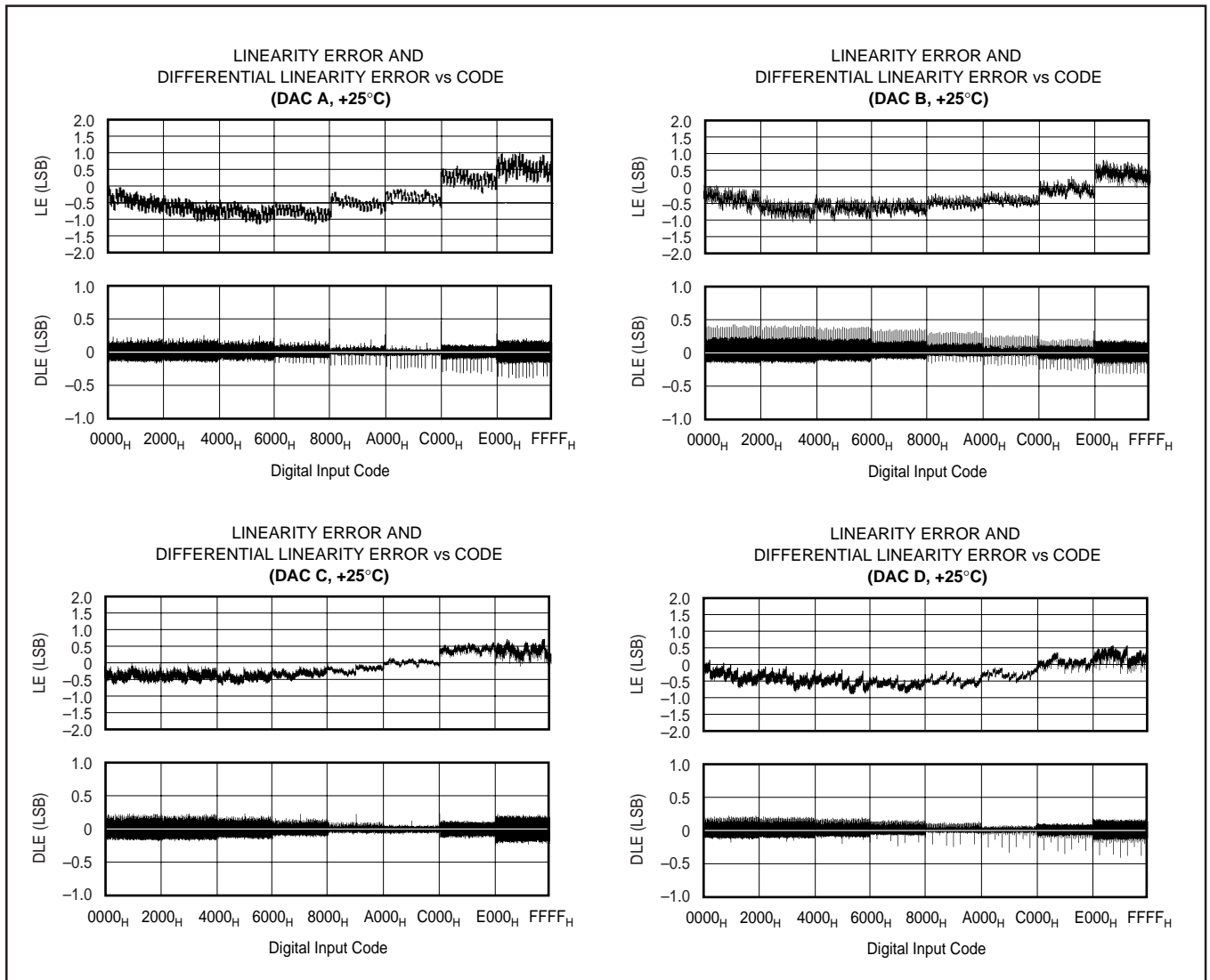

FIGURE 7. Integral Linearity and Differential Linearity Error Curves for Figure 8.

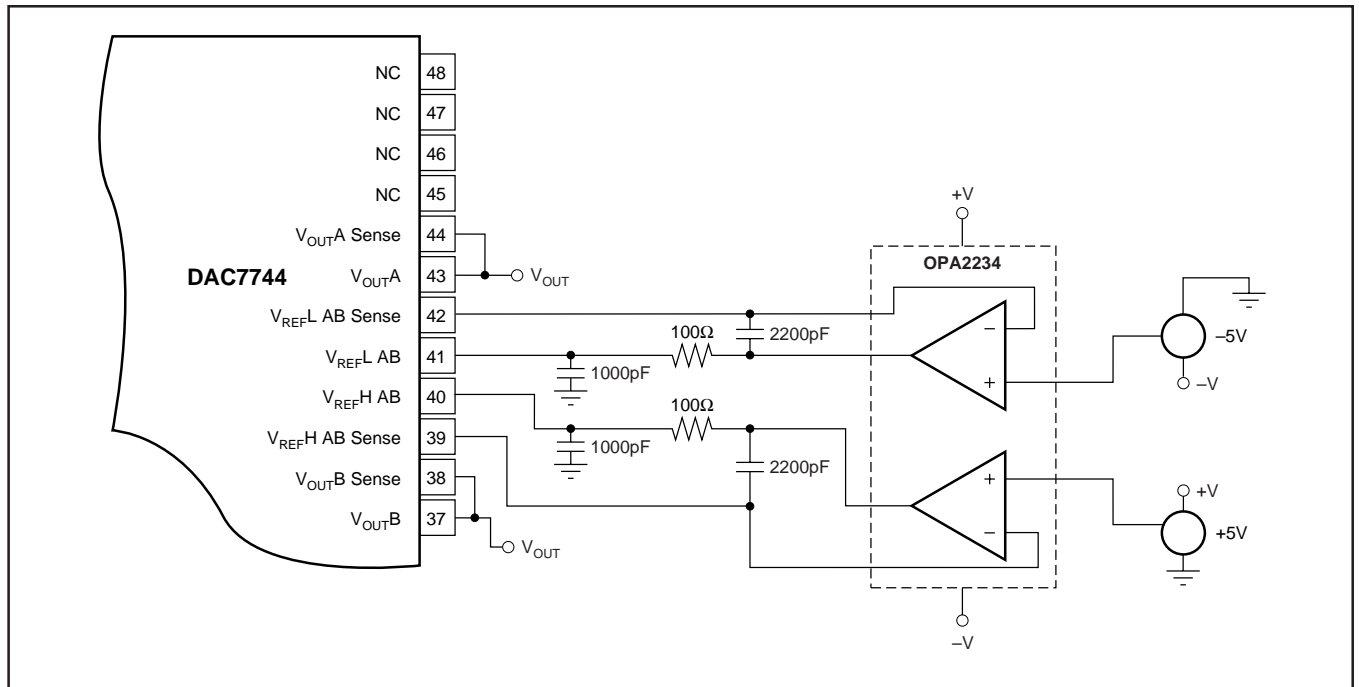

FIGURE 8. Dual-Supply Buffered Referenced with  $V_{REFL} = -5V$  and  $V_{REFH} = +5V$  (1/2 DAC7744).

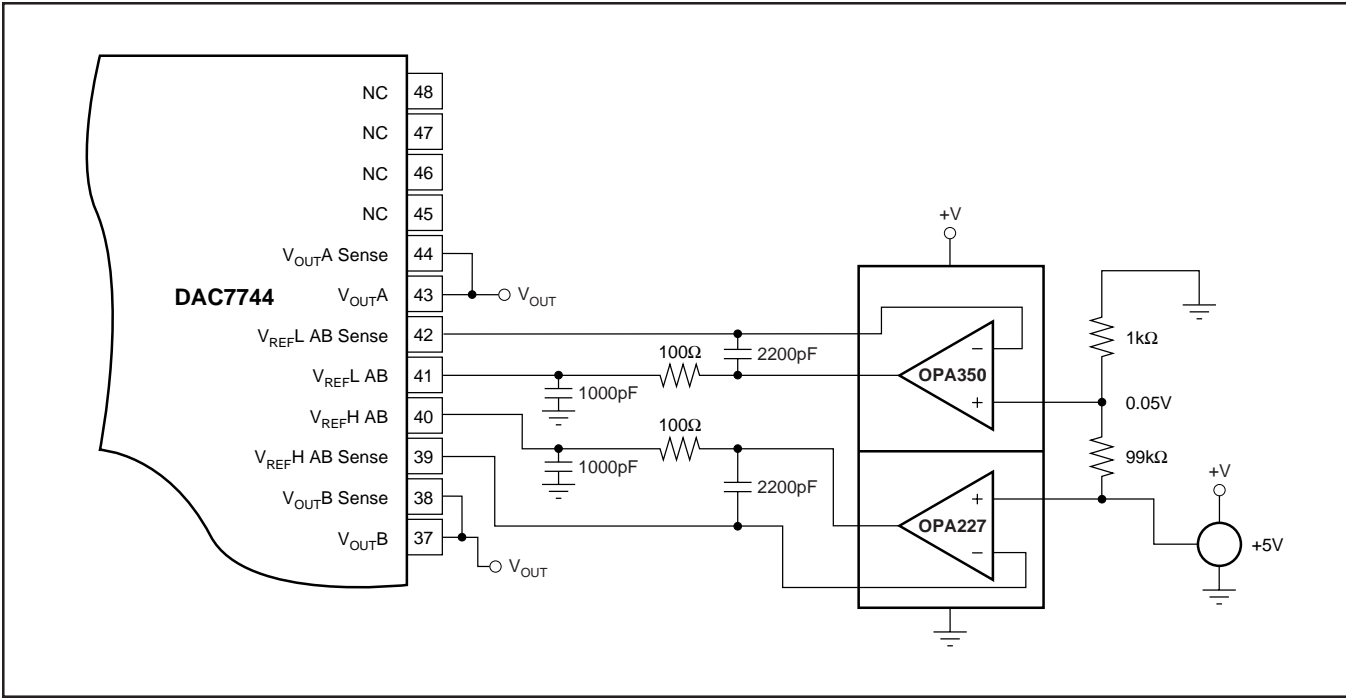

FIGURE 9. Single-Supply Buffered Reference with a Reference Low of 50mV and Reference High of +5V.

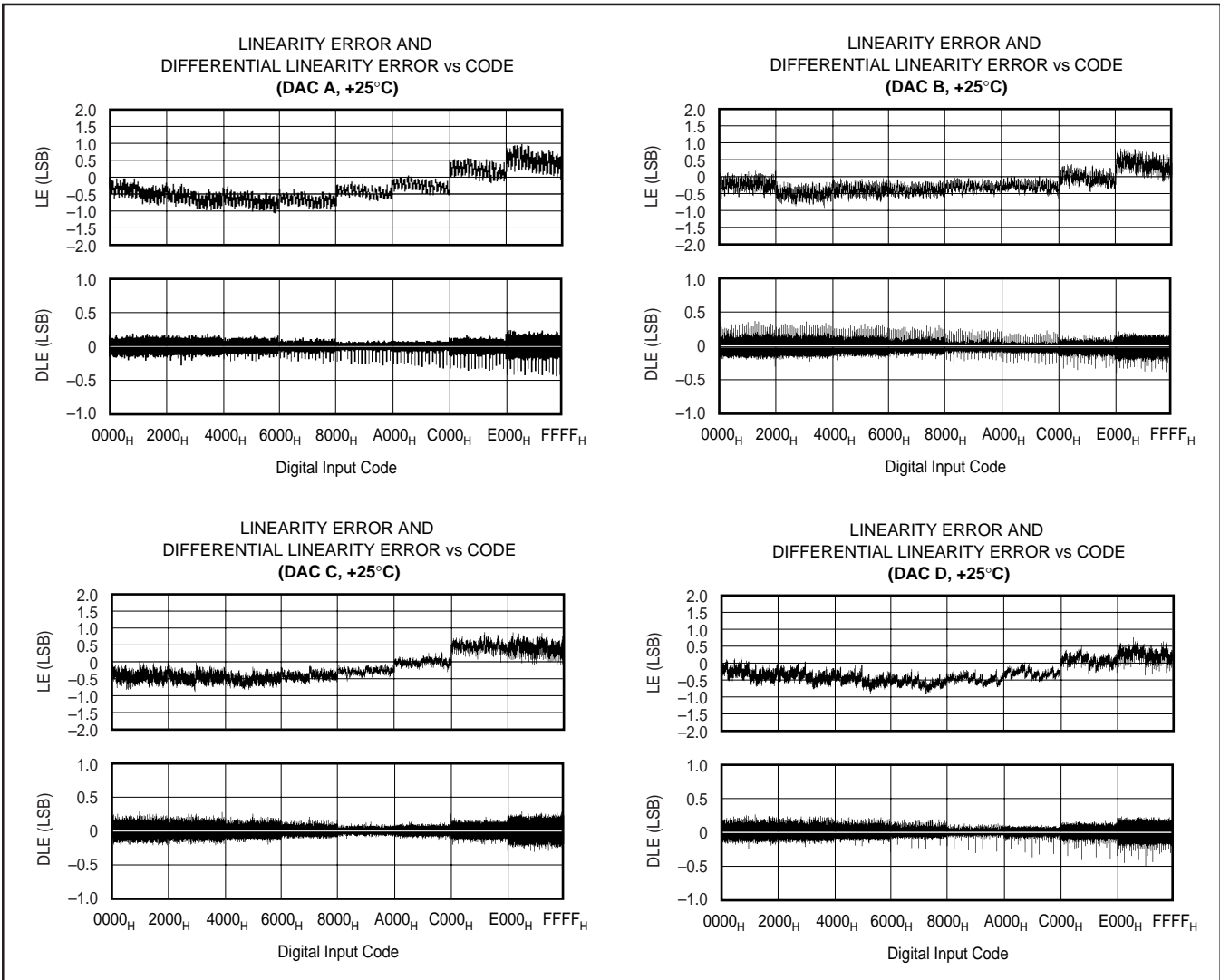

FIGURE 10. Integral Linearity and Differential Linearity Error Curves for Figure 9.

| A1 | A0 | R/W | $\overline{CS}$ | RST | RSTSEL | LOADDACS | INPUT REGISTER | DAC REGISTER      | MODE              | DAC |
|----|----|-----|-----------------|-----|--------|----------|----------------|-------------------|-------------------|-----|
| L  | L  | L   | L               | X   | X      | X        | Write          | Hold              | Write Input       | A   |
| L  | H  | L   | L               | X   | X      | X        | Write          | Hold              | Write Input       | B   |
| H  | L  | L   | L               | X   | X      | X        | Write          | Hold              | Write Input       | C   |
| H  | H  | L   | L               | X   | X      | X        | Write          | Hold              | Write Input       | D   |
| L  | L  | H   | L               | X   | X      | X        | Read           | Hold              | Read Input        | A   |
| L  | H  | H   | L               | X   | X      | X        | Read           | Hold              | Read Input        | B   |
| H  | L  | H   | L               | X   | X      | X        | Read           | Hold              | Read Input        | C   |
| H  | H  | H   | L               | X   | X      | X        | Read           | Hold              | Read Input        | D   |
| X  | X  | X   | H               | X   | X      | ↑        | Hold           | Write             | Update            | All |
| X  | X  | X   | H               | X   | X      | H        | Hold           | Hold              | Hold              | All |
| X  | X  | X   | X               | ↑   | L      | X        |                | Reset to Zero     | Reset to Zero     | All |
| X  | X  | X   | X               | ↑   | H      | X        |                | Reset to Midscale | Reset to Midscale | All |

TABLE I. DAC7744 Logic Truth Table.

## DIGITAL INTERFACE

Table I shows the basic control logic for the DAC7744. Note that each DAC register is edge triggered and not level triggered. When the LOADDACS signal is transitioned to HIGH, the digital word currently in the DAC register is latched. The first set of registers (the input registers) are triggered via the A0, A1, R/W, and  $\overline{CS}$  inputs. Only one of these registers is transparent at any given time.

The double-buffered architecture is designed mainly so that each DAC input register can be written to at any time and then all DAC voltages updated simultaneously by the rising edge of LOADDACS. It also allows a DAC input register to be written to at any point then the DAC output voltages can be synchronously changed via a trigger signal connected to LOADDACS.

## DIGITAL TIMING

Figure 11 and Table II provide detailed timing for the digital interface of the DAC7744.

## DIGITAL INPUT CODING

The DAC7744 input data is in Straight Binary format. The output voltage is given by Equation 1.

$$V_{OUT} = V_{REFL} + \frac{(V_{REFH} - V_{REFL}) \cdot N}{65,536} \quad (1)$$

where N is the digital input code. This equation does not include the effects of offset (zero scale) or gain (full scale) errors.

## DIGITALLY-PROGRAMMABLE CURRENT SOURCE

The DAC7744 offers a unique set of features that allows a wide range of flexibility in designing applications circuits such as programmable current sources. The DAC7744 offers both a differential reference input as well as an open-loop configuration around the output amplifier. The open-loop configuration around the output amplifier allows transistor to be placed within the loop to implement a digitally-programmable, uni-directional current source. The availability of a differential reference also allows programmability for both the full-scale and zero-scale currents. The output current is calculated as:

$$I_{OUT} = \left( \left( \frac{V_{REFH} - V_{REFL}}{R_{SENSE}} \right) \cdot \left( \frac{N}{65,536} \right) \right) + (V_{REFL} / R_{SENSE}) \quad (2)$$

Figure 12 shows a DAC7744 in a 4-to-20mA current output configuration. The output current can be determined by Equation 3:

$$I_{OUT} = \left( \left( \frac{5V - 1V}{250\Omega} \right) \cdot \left( \frac{N}{65,536} \right) \right) + \left( \frac{1V}{250\Omega} \right) \quad (3)$$

At full scale, the output current is 16mA plus the 4mA for the zero current. At zero scale, the output current is the offset current of 4mA (1V/250Ω).

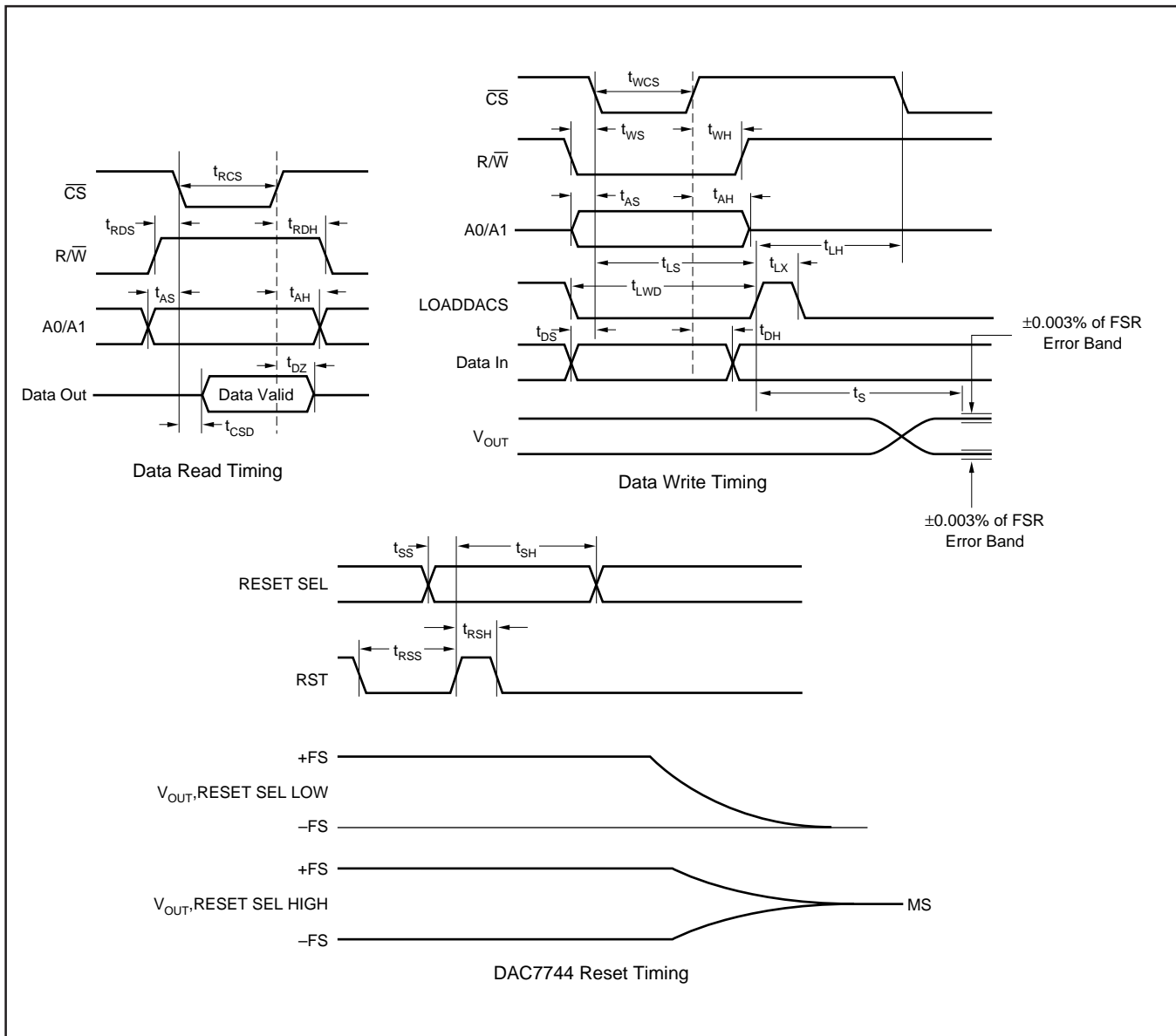

FIGURE 11. Digital Input and Output Timing.

| SYMBOL    | DESCRIPTION  | MIN | TYP | MAX | UNITS   |
|-----------|--|-----|-----|-----|---------|
| $t_{RCS}$ | $\overline{CS}$ LOW for Read                       | 100 |     |     | ns      |
| $t_{RDS}$ | $R/\overline{W}$ HIGH to $\overline{CS}$ LOW       | 10  |     |     | ns      |
| $t_{RDH}$ | $R/\overline{W}$ HIGH after $\overline{CS}$ HIGH   | 10  |     |     | ns      |
| $t_{DZ}$  | $\overline{CS}$ HIGH to Data Bus in High Impedance | 10  |     | 70  | ns      |
| $t_{CSD}$ | $\overline{CS}$ LOW to Data Bus Valid              |     | 85  | 130 | ns      |
| $t_{WCS}$ | $\overline{CS}$ LOW for Write                      | 40  |     |     | ns      |
| $t_{WS}$  | $R/\overline{W}$ LOW to $\overline{CS}$ LOW        | 0   |     |     | ns      |
| $t_{WH}$  | $R/\overline{W}$ LOW after $\overline{CS}$ HIGH    | 10  |     |     | ns      |
| $t_{AS}$  | Address Valid to $\overline{CS}$ LOW               | 0   |     |     | ns      |
| $t_{AH}$  | Address Valid after $\overline{CS}$ HIGH           | 15  |     |     | ns      |
| $t_{LS}$  | $\overline{CS}$ LOW to LOADDACS HIGH               | 40  |     |     | ns      |
| $t_{LH}$  | $\overline{CS}$ LOW after LOADDACS HIGH            | 80  |     |     | ns      |
| $t_{LX}$  | LOADDACS HIGH                                      | 40  |     |     | ns      |
| $t_{DS}$  | Data Valid to $\overline{CS}$ LOW                  | 0   |     |     | ns      |
| $t_{DH}$  | Data Valid after $\overline{CS}$ HIGH              | 15  |     |     | ns      |
| $t_{LWD}$ | LOADDACS LOW                                       | 40  |     |     | ns      |
| $t_{SS}$  | RSTSEL Valid Before RESET HIGH                     | 0   |     |     | ns      |
| $t_{SH}$  | RSTSEL Valid After RESET HIGH                      | 120 |     |     | ns      |
| $t_{RSS}$ | RESET LOW Before RESET HIGH                        | 10  |     |     | ns      |
| $t_{RSH}$ | RESET LOW After RESET HIGH                         | 10  |     |     | ns      |
| $t_s$     | Settling Time                                      |     |     | 11  | $\mu$ s |

TABLE II. Timing Specifications ( $T_A = -40^\circ\text{C}$  to  $+85^\circ\text{C}$ ).

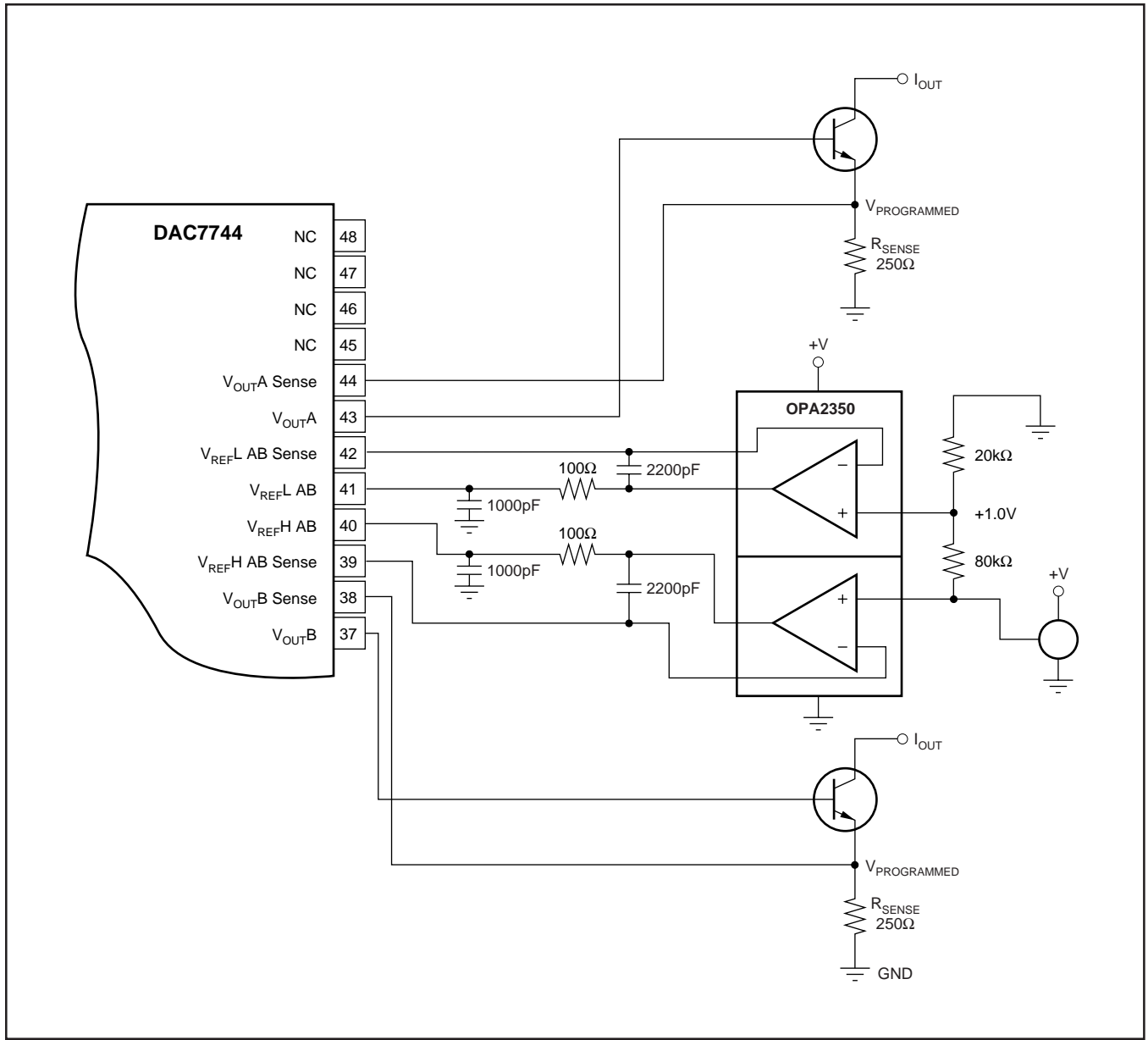

FIGURE 12. 4-to-20mA Digitally-Controlled Current Source (1/2 DAC7744).

**PACKAGING INFORMATION**

| Orderable Device | Status<br>(1) | Package Type | Package<br>Drawing | Pins | Package<br>Qty | Eco Plan<br>(2)            | Lead/Ball Finish<br>(6) | MSL Peak Temp<br>(3) | Op Temp (°C) | Device Marking<br>(4/5) | Samples                 |
|------------------|---------------|--------------|--------------------|------|----------------|----------------------------|-------------------------|----------------------|--------------|-------------------------|-------------------------|
| DAC7744E         | ACTIVE        | SSOP         | DL                 | 48   | 25             | Green (RoHS<br>& no Sb/Br) | CU NIPDAU               | Level-3-260C-168 HR  | -40 to 85    | DAC7744E                | <a href="#">Samples</a> |
| DAC7744E/1K      | ACTIVE        | SSOP         | DL                 | 48   | 1000           | Green (RoHS<br>& no Sb/Br) | CU NIPDAU               | Level-3-260C-168 HR  | -40 to 85    | DAC7744E                | <a href="#">Samples</a> |
| DAC7744E/1KG4    | ACTIVE        | SSOP         | DL                 | 48   | 1000           | Green (RoHS<br>& no Sb/Br) | CU NIPDAU               | Level-3-260C-168 HR  | -40 to 85    | DAC7744E                | <a href="#">Samples</a> |
| DAC7744EB        | ACTIVE        | SSOP         | DL                 | 48   | 25             | Green (RoHS<br>& no Sb/Br) | CU NIPDAU               | Level-3-260C-168 HR  | -40 to 85    | DAC7744E<br>B           | <a href="#">Samples</a> |
| DAC7744EB/1K     | ACTIVE        | SSOP         | DL                 | 48   | 1000           | Green (RoHS<br>& no Sb/Br) | CU NIPDAU               | Level-3-260C-168 HR  | -40 to 85    | DAC7744E<br>B           | <a href="#">Samples</a> |
| DAC7744EBG4      | ACTIVE        | SSOP         | DL                 | 48   | 25             | Green (RoHS<br>& no Sb/Br) | CU NIPDAU               | Level-3-260C-168 HR  | -40 to 85    | DAC7744E<br>B           | <a href="#">Samples</a> |
| DAC7744EC        | ACTIVE        | SSOP         | DL                 | 48   | 25             | Green (RoHS<br>& no Sb/Br) | CU NIPDAU               | Level-3-260C-168 HR  | -40 to 85    | DAC7744E<br>C           | <a href="#">Samples</a> |
| DAC7744EC/1K     | ACTIVE        | SSOP         | DL                 | 48   | 1000           | Green (RoHS<br>& no Sb/Br) | CU NIPDAU               | Level-3-260C-168 HR  | -40 to 85    | DAC7744E<br>C           | <a href="#">Samples</a> |
| DAC7744ECG4      | ACTIVE        | SSOP         | DL                 | 48   | 25             | Green (RoHS<br>& no Sb/Br) | CU NIPDAU               | Level-3-260C-168 HR  | -40 to 85    | DAC7744E<br>C           | <a href="#">Samples</a> |
| DAC7744EG4       | ACTIVE        | SSOP         | DL                 | 48   | 25             | Green (RoHS<br>& no Sb/Br) | CU NIPDAU               | Level-3-260C-168 HR  | -40 to 85    | DAC7744E                | <a href="#">Samples</a> |

(1) The marketing status values are defined as follows:

**ACTIVE:** Product device recommended for new designs.

**LIFEBUY:** TI has announced that the device will be discontinued, and a lifetime-buy period is in effect.

**NRND:** Not recommended for new designs. Device is in production to support existing customers, but TI does not recommend using this part in a new design.

**PREVIEW:** Device has been announced but is not in production. Samples may or may not be available.

**OBSOLETE:** TI has discontinued the production of the device.

(2) Eco Plan - The planned eco-friendly classification: Pb-Free (RoHS), Pb-Free (RoHS Exempt), or Green (RoHS & no Sb/Br) - please check <http://www.ti.com/productcontent> for the latest availability information and additional product content details.

**TBD:** The Pb-Free/Green conversion plan has not been defined.

**Pb-Free (RoHS):** TI's terms "Lead-Free" or "Pb-Free" mean semiconductor products that are compatible with the current RoHS requirements for all 6 substances, including the requirement that lead not exceed 0.1% by weight in homogeneous materials. Where designed to be soldered at high temperatures, TI Pb-Free products are suitable for use in specified lead-free processes.

**Pb-Free (RoHS Exempt):** This component has a RoHS exemption for either 1) lead-based flip-chip solder bumps used between the die and package, or 2) lead-based die adhesive used between the die and leadframe. The component is otherwise considered Pb-Free (RoHS compatible) as defined above.

**Green (RoHS & no Sb/Br):** TI defines "Green" to mean Pb-Free (RoHS compatible), and free of Bromine (Br) and Antimony (Sb) based flame retardants (Br or Sb do not exceed 0.1% by weight in homogeneous material)



- (3) MSL, Peak Temp. - The Moisture Sensitivity Level rating according to the JEDEC industry standard classifications, and peak solder temperature.
- (4) There may be additional marking, which relates to the logo, the lot trace code information, or the environmental category on the device.
- (5) Multiple Device Markings will be inside parentheses. Only one Device Marking contained in parentheses and separated by a "~" will appear on a device. If a line is indented then it is a continuation of the previous line and the two combined represent the entire Device Marking for that device.
- (6) Lead/Ball Finish - Orderable Devices may have multiple material finish options. Finish options are separated by a vertical ruled line. Lead/Ball Finish values may wrap to two lines if the finish value exceeds the maximum column width.

**Important Information and Disclaimer:**The information provided on this page represents TI's knowledge and belief as of the date that it is provided. TI bases its knowledge and belief on information provided by third parties, and makes no representation or warranty as to the accuracy of such information. Efforts are underway to better integrate information from third parties. TI has taken and continues to take reasonable steps to provide representative and accurate information but may not have conducted destructive testing or chemical analysis on incoming materials and chemicals. TI and TI suppliers consider certain information to be proprietary, and thus CAS numbers and other limited information may not be available for release.

In no event shall TI's liability arising out of such information exceed the total purchase price of the TI part(s) at issue in this document sold by TI to Customer on an annual basis.

**TAPE AND REEL INFORMATION**

**QUADRANT ASSIGNMENTS FOR PIN 1 ORIENTATION IN TAPE**

\*All dimensions are nominal

| Device       | Package Type | Package Drawing | Pins | SPQ  | Reel Diameter (mm) | Reel Width W1 (mm) | A0 (mm) | B0 (mm) | K0 (mm) | P1 (mm) | W (mm) | Pin1 Quadrant |
|--------------|--------------|-----------------|------|------|--------------------|--------------------|---------|---------|---------|---------|--------|---------------|
| DAC7744E/1K  | SSOP         | DL              | 48   | 1000 | 330.0              | 32.4               | 11.35   | 16.2    | 3.1     | 16.0    | 32.0   | Q1            |
| DAC7744EB/1K | SSOP         | DL              | 48   | 1000 | 330.0              | 32.4               | 11.35   | 16.2    | 3.1     | 16.0    | 32.0   | Q1            |
| DAC7744EC/1K | SSOP         | DL              | 48   | 1000 | 330.0              | 32.4               | 11.35   | 16.2    | 3.1     | 16.0    | 32.0   | Q1            |

**TAPE AND REEL BOX DIMENSIONS**

\*All dimensions are nominal

| Device       | Package Type | Package Drawing | Pins | SPQ  | Length (mm) | Width (mm) | Height (mm) |
|--------------|--------------|-----------------|------|------|-------------|------------|-------------|
| DAC7744E/1K  | SSOP         | DL              | 48   | 1000 | 367.0       | 367.0      | 55.0        |
| DAC7744EB/1K | SSOP         | DL              | 48   | 1000 | 367.0       | 367.0      | 55.0        |
| DAC7744EC/1K | SSOP         | DL              | 48   | 1000 | 367.0       | 367.0      | 55.0        |

## IMPORTANT NOTICE

Texas Instruments Incorporated and its subsidiaries (TI) reserve the right to make corrections, enhancements, improvements and other changes to its semiconductor products and services per JESD46, latest issue, and to discontinue any product or service per JESD48, latest issue. Buyers should obtain the latest relevant information before placing orders and should verify that such information is current and complete. All semiconductor products (also referred to herein as "components") are sold subject to TI's terms and conditions of sale supplied at the time of order acknowledgment.

TI warrants performance of its components to the specifications applicable at the time of sale, in accordance with the warranty in TI's terms and conditions of sale of semiconductor products. Testing and other quality control techniques are used to the extent TI deems necessary to support this warranty. Except where mandated by applicable law, testing of all parameters of each component is not necessarily performed.

TI assumes no liability for applications assistance or the design of Buyers' products. Buyers are responsible for their products and applications using TI components. To minimize the risks associated with Buyers' products and applications, Buyers should provide adequate design and operating safeguards.

TI does not warrant or represent that any license, either express or implied, is granted under any patent right, copyright, mask work right, or other intellectual property right relating to any combination, machine, or process in which TI components or services are used. Information published by TI regarding third-party products or services does not constitute a license to use such products or services or a warranty or endorsement thereof. Use of such information may require a license from a third party under the patents or other intellectual property of the third party, or a license from TI under the patents or other intellectual property of TI.

Reproduction of significant portions of TI information in TI data books or data sheets is permissible only if reproduction is without alteration and is accompanied by all associated warranties, conditions, limitations, and notices. TI is not responsible or liable for such altered documentation. Information of third parties may be subject to additional restrictions.

Resale of TI components or services with statements different from or beyond the parameters stated by TI for that component or service voids all express and any implied warranties for the associated TI component or service and is an unfair and deceptive business practice. TI is not responsible or liable for any such statements.

Buyer acknowledges and agrees that it is solely responsible for compliance with all legal, regulatory and safety-related requirements concerning its products, and any use of TI components in its applications, notwithstanding any applications-related information or support that may be provided by TI. Buyer represents and agrees that it has all the necessary expertise to create and implement safeguards which anticipate dangerous consequences of failures, monitor failures and their consequences, lessen the likelihood of failures that might cause harm and take appropriate remedial actions. Buyer will fully indemnify TI and its representatives against any damages arising out of the use of any TI components in safety-critical applications.

In some cases, TI components may be promoted specifically to facilitate safety-related applications. With such components, TI's goal is to help enable customers to design and create their own end-product solutions that meet applicable functional safety standards and requirements. Nonetheless, such components are subject to these terms.

No TI components are authorized for use in FDA Class III (or similar life-critical medical equipment) unless authorized officers of the parties have executed a special agreement specifically governing such use.

Only those TI components which TI has specifically designated as military grade or "enhanced plastic" are designed and intended for use in military/aerospace applications or environments. Buyer acknowledges and agrees that any military or aerospace use of TI components which have **not** been so designated is solely at the Buyer's risk, and that Buyer is solely responsible for compliance with all legal and regulatory requirements in connection with such use.

TI has specifically designated certain components as meeting ISO/TS16949 requirements, mainly for automotive use. In any case of use of non-designated products, TI will not be responsible for any failure to meet ISO/TS16949.

### Products

|                              |  |
|------------------------------|--|
| Audio                        | <a href="http://www.ti.com/audio">www.ti.com/audio</a>                               |
| Amplifiers                   | <a href="http://amplifier.ti.com">amplifier.ti.com</a>                               |
| Data Converters              | <a href="http://dataconverter.ti.com">dataconverter.ti.com</a>                       |
| DLP® Products                | <a href="http://www.dlp.com">www.dlp.com</a>   |
| DSP                          | <a href="http://dsp.ti.com">dsp.ti.com</a>   |
| Clocks and Timers            | <a href="http://www.ti.com/clocks">www.ti.com/clocks</a>                             |
| Interface                    | <a href="http://interface.ti.com">interface.ti.com</a>                               |
| Logic                        | <a href="http://logic.ti.com">logic.ti.com</a>                                       |
| Power Mgmt                   | <a href="http://power.ti.com">power.ti.com</a>                                       |
| Microcontrollers             | <a href="http://microcontroller.ti.com">microcontroller.ti.com</a>                   |
| RFID                         | <a href="http://www.ti-rfid.com">www.ti-rfid.com</a>                                 |
| OMAP Applications Processors | <a href="http://www.ti.com/omap">www.ti.com/omap</a>                                 |
| Wireless Connectivity        | <a href="http://www.ti.com/wirelessconnectivity">www.ti.com/wirelessconnectivity</a> |

### Applications

|                               |  |
|-------------------------------|--|
| Automotive and Transportation | <a href="http://www.ti.com/automotive">www.ti.com/automotive</a>                         |
| Communications and Telecom    | <a href="http://www.ti.com/communications">www.ti.com/communications</a>                 |
| Computers and Peripherals     | <a href="http://www.ti.com/computers">www.ti.com/computers</a>                           |
| Consumer Electronics          | <a href="http://www.ti.com/consumer-apps">www.ti.com/consumer-apps</a>                   |
| Energy and Lighting           | <a href="http://www.ti.com/energy">www.ti.com/energy</a>                                 |
| Industrial                    | <a href="http://www.ti.com/industrial">www.ti.com/industrial</a>                         |
| Medical                       | <a href="http://www.ti.com/medical">www.ti.com/medical</a>                               |
| Security                      | <a href="http://www.ti.com/security">www.ti.com/security</a>                             |
| Space, Avionics and Defense   | <a href="http://www.ti.com/space-avionics-defense">www.ti.com/space-avionics-defense</a> |
| Video and Imaging             | <a href="http://www.ti.com/video">www.ti.com/video</a>                                   |

### TI E2E Community

[e2e.ti.com](http://e2e.ti.com)