

# DAC8560 16-Bit, Ultra-Low Glitch, Voltage Output Digital-to-Analog Converter With 2.5-V, 2-ppm/°C Internal Reference

## 1 Features

- Relative Accuracy: 4 LSB
- Glitch Energy: 0.15 nV-s
- *MicroPower* Operation: 510  $\mu$ A at 2.7 V
- Internal Reference:
  - 2.5-V Reference Voltage (Enabled by Default)
  - 0.02% Initial Accuracy
  - 2-ppm/°C Temperature Drift (Typical)
  - 5-ppm/°C Temperature Drift (Maximum)
  - 20-mA Sink/Source Capability
- Power-On Reset to Zero
- Power Supply: 2.7 V to 5.5 V
- 16-Bit Monotonic Over Temperature Range
- Settling Time: 10  $\mu$ s to  $\pm$ 0.003% FSR
- Low-Power Serial Interface With Schmitt-Triggered Inputs
- On-Chip Output Buffer Amplifier With Rail-to-Rail Operation
- Power-Down Capability
- Drop-In Compatible With [DAC8531/01](#) and [DAC8550 /51](#)
- Temperature Range:  $-40^{\circ}\text{C}$  to  $+105^{\circ}\text{C}$
- Available in a Tiny 8-Pin VSSOP Package

## 2 Applications

- Process Control
- Data Acquisition Systems
- Closed-Loop Servo-Control
- PC Peripherals
- Portable Instrumentation

## 3 Description

The DAC8560 is a low-power, voltage output, 16-bit digital-to-analog converter (DAC). The DAC8560 includes a 2.5-V, 2-ppm/°C internal reference (enabled by default), giving a full-scale output voltage range of 0 V to 2.5 V. The internal reference has an initial accuracy of 0.02% and can source up to 20 mA at the  $V_{\text{REF}}$  pin. The device is monotonic, provides very good linearity, and minimizes undesired code-to-code transient voltages (glitch). The DAC8560 uses a versatile 3-wire serial interface that operates at clock rates up to 30 MHz. It is compatible with standard SPI, QSPI, Microwire, and digital-signal-processor (DSP) interfaces.

The DAC8560 incorporates a power-on-reset (POR) circuit that ensures the DAC output powers up at zero scale and remains there until a valid code is written to the device. The DAC8560 contains a power-down feature, accessed over the serial interface, that reduces the current consumption of the device to 1.2  $\mu$ A at 5 V.

The low-power consumption, internal reference, and small footprint make this device ideal for portable, battery-operated equipment. The power consumption is 2.6 mW at 5 V, reducing to 6  $\mu$ W in power-down mode.

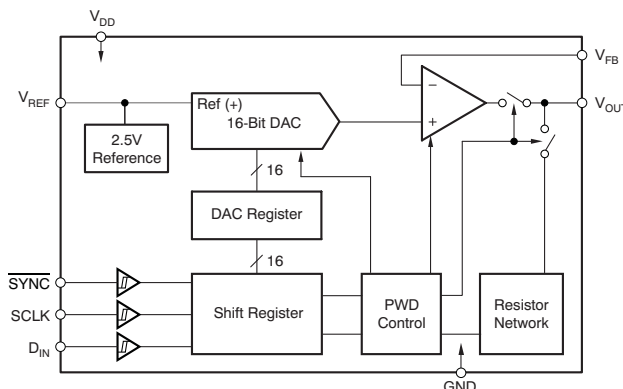
The DAC8560 is available in an 8-pin VSSOP package.

### Device Information<sup>(1)</sup>

PART NUMBER	PACKAGE	BODY SIZE (NOM)
DAC8560	VSSOP (8)	3.00 mm x 3.00 mm

(1) For all available packages, see the orderable addendum at the end of the data sheet.

### Functional Block Diagram



## Table of Contents

<b>1 Features</b> .....	<b>1</b>	7.3 Feature Description .....	<b>19</b>
<b>2 Applications</b> .....	<b>1</b>	7.4 Device Functional Modes .....	<b>24</b>
<b>3 Description</b> .....	<b>1</b>	7.5 Programming .....	<b>25</b>
<b>4 Revision History</b> .....	<b>2</b>	7.6 Register Maps .....	<b>26</b>
<b>5 Pin Configuration and Functions</b> .....	<b>3</b>	<b>8 Application and Implementation</b> .....	<b>27</b>
<b>6 Specifications</b> .....	<b>4</b>	8.1 Application Information .....	<b>27</b>
6.1 Absolute Maximum Ratings .....	<b>4</b>	8.2 Typical Applications .....	<b>27</b>
6.2 ESD Ratings .....	<b>4</b>	<b>9 Power Supply Recommendations</b> .....	<b>32</b>
6.3 Recommended Operating Conditions .....	<b>4</b>	<b>10 Layout</b> .....	<b>32</b>
6.4 Thermal Information .....	<b>4</b>	10.1 Layout Guidelines .....	<b>32</b>
6.5 Electrical Characteristics .....	<b>5</b>	10.2 Layout Example .....	<b>32</b>
6.6 Timing Requirements .....	<b>7</b>	<b>11 Device and Documentation Support</b> .....	<b>33</b>
6.7 Typical Characteristics: Internal Reference .....	<b>8</b>	11.1 Documentation Support .....	<b>33</b>
6.8 Typical Characteristics: DAC at $V_{DD} = 5\text{ V}$ .....	<b>10</b>	11.2 Receiving Notification of Documentation Updates .....	<b>33</b>
6.9 Typical Characteristics: DAC at $V_{DD} = 3.6\text{ V}$ .....	<b>15</b>	11.3 Community Resource .....	<b>33</b>
6.10 Typical Characteristics: DAC at $V_{DD} = 2.7\text{ V}$ .....	<b>15</b>	11.4 Trademarks .....	<b>33</b>
<b>7 Detailed Description</b> .....	<b>19</b>	11.5 Electrostatic Discharge Caution .....	<b>33</b>
7.1 Overview .....	<b>19</b>	11.6 Glossary .....	<b>33</b>
7.2 Functional Block Diagram .....	<b>19</b>	<b>12 Mechanical, Packaging, and Orderable Information</b> .....	<b>33</b>

## 4 Revision History

NOTE: Page numbers for previous revisions may differ from page numbers in the current version.

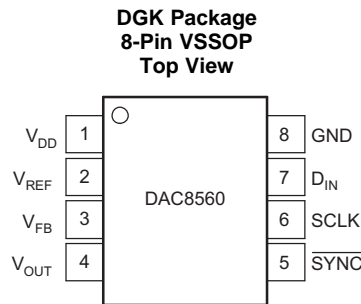
<b>Changes from Revision B (November 2011) to Revision C</b>	<b>Page</b>
<ul style="list-style-type: none"> <li>Added topnav link for TI Designs, <i>Device Information</i>, <i>ESD Ratings</i>, <i>Recommended Operating Conditions</i>, and <i>Thermal Information</i> tables, <i>Feature Description</i> section, <i>Device Functional Modes</i>, <i>Application and Implementation</i> section, <i>Power Supply Recommendations</i> section, <i>Layout</i> section, <i>Device and Documentation Support</i> section, and <i>Mechanical, Packaging, and Orderable Information</i> section .....</li> </ul>	<b>1</b>

<b>Changes from Revision A (November 2011) to Revision B</b>	<b>Page</b>
<ul style="list-style-type: none"> <li>Changed Revision date from A, May 2011 to B, November 2011 .....</li> <li>Changed "Zero-code error drift" in the ELEC CHARA table, TYP from <math>\pm 20</math> to <math>\pm 4</math> .....</li> </ul>	<b>1</b> <b>5</b>

<b>Changes from Original (December 2006) to Revision A</b>	<b>Page</b>
<ul style="list-style-type: none"> <li>Changed Output Voltage parameter min/max values from 2.4995 and 2.5005 to 2.4975 and 2.5025, respectively .....</li> <li>Changed Initial Accuracy parameter min/max values from <math>-0.02</math> and <math>0.02</math> to <math>-0.1</math> and <math>0.1</math>, respectively .....</li> </ul>	<b>6</b> <b>6</b>

<b>Changes from Revision A (May 2011) to Revision B</b>	<b>Page</b>
<ul style="list-style-type: none"> <li>Changed Revision date from A, May 2011 to B, November 2011 .....</li> <li>Changed "Zero-code error drift" in the ELEC CHARA table, TYP from <math>\pm 20</math> to <math>\pm 4</math> .....</li> </ul>	<b>1</b> <b>5</b>

## 5 Pin Configuration and Functions



### Pin Functions

PIN		I/O	DESCRIPTION
NO.	NAME		
1	V <sub>DD</sub>	PWR	Power supply input, 2.7 V to 5.5 V
2	V <sub>REF</sub>	I/O	Reference voltage input/output
3	V <sub>FB</sub>	I	Feedback connection for the output amplifier. For voltage output operation, tie to V <sub>OUT</sub> externally.
4	V <sub>OUT</sub>	O	Analog output voltage from DAC. The output amplifier has rail-to-rail operation.
5	$\overline{\text{SYNC}}$	I	Level-triggered control input (active LOW). This is the frame synchronization signal for the input data. When $\overline{\text{SYNC}}$ goes LOW, it enables the input shift register, and data is sampled on subsequent falling clock edges. The DAC output updates following the 24th clock. If $\overline{\text{SYNC}}$ is taken HIGH before the 24th clock edge, the rising edge of $\overline{\text{SYNC}}$ acts as an interrupt, and the write sequence is ignored by the DAC8560. Schmitt-Trigger logic input.
6	SCLK	I	Serial clock input, Schmitt-Trigger logic input.
7	D <sub>IN</sub>	I	Serial data input. Data is clocked into the 24-bit input shift register on each falling edge of the serial clock input. Schmitt-Trigger logic input.
8	GND	GND	Ground reference point for all circuitry on the device.

## 6 Specifications

### 6.1 Absolute Maximum Ratings

over operating free-air temperature range (unless otherwise noted)<sup>(1)</sup>

	MIN	MAX	UNIT
V <sub>DD</sub> to GND	–0.3	6	V
Digital input voltage to GND	–0.3	V <sub>DD</sub> + 0.3	V
V <sub>OUT</sub> to GND	–0.3	V <sub>DD</sub> + 0.3	V
Power dissipation (DGK)		(T <sub>J(MAX)</sub> – T <sub>A</sub> ) / R <sub>θJA</sub>	
Operating temperature	–40	105	°C
Junction temperature, T <sub>J(MAX)</sub>		150	°C
Storage temperature, T <sub>stg</sub>	–65	150	°C

- (1) Stresses beyond those listed under *Absolute Maximum Ratings* may cause permanent damage to the device. These are stress ratings only, which do not imply functional operation of the device at these or any other conditions beyond those indicated under *Recommended Operating Conditions*. Exposure to absolute-maximum-rated conditions for extended periods may affect device reliability.

### 6.2 ESD Ratings

		VALUE	UNIT
V <sub>(ESD)</sub> Electrostatic discharge	Human-body model (HBM), per ANSI/ESDA/JEDEC JS-001 <sup>(1)</sup>	±4000	V
	Charged-device model (CDM), per JEDEC specification JESD22-C101 <sup>(2)</sup>	±1500	

- (1) JEDEC document JEP155 states that 500-V HBM allows safe manufacturing with a standard ESD control process.

- (2) JEDEC document JEP157 states that 250-V CDM allows safe manufacturing with a standard ESD control process.

### 6.3 Recommended Operating Conditions

over operating free-air temperature range (unless otherwise noted)

		MIN	NOM	MAX	UNIT
V <sub>DD</sub> Supply voltage (V <sub>DD</sub> to GND)		2.7		5.5	V
	Digital input voltage (D <sub>IN</sub> , SCLK, and SYNC)	0		V <sub>DD</sub>	V
V <sub>FB</sub> Output amplifier feedback input			V <sub>OUT</sub>		V
T <sub>A</sub> Operating ambient temperature		–40		125	°C

### 6.4 Thermal Information

THERMAL METRIC <sup>(1)</sup>		DAC8560	UNIT
		DGK (VSSOP)	
		8 PINS	
R <sub>θJA</sub>	Junction-to-ambient thermal resistance	206	°C/W
R <sub>θJC(top)</sub>	Junction-to-case (top) thermal resistance	44	°C/W
R <sub>θJB</sub>	Junction-to-board thermal resistance	94.2	°C/W
ψ <sub>JT</sub>	Junction-to-top characterization parameter	10.2	°C/W
ψ <sub>JB</sub>	Junction-to-board characterization parameter	92.7	°C/W

- (1) For more information about traditional and new thermal metrics, see the [Semiconductor and IC Package Thermal Metrics](#) application report.

## 6.5 Electrical Characteristics

 $V_{DD} = 2.7\text{ V to }5.5\text{ V}$ ,  $-40^{\circ}\text{C to }+105^{\circ}\text{C}$  range (unless otherwise noted)

PARAMETER		TEST CONDITIONS	MIN	TYP	MAX	UNIT
<b>STATIC PERFORMANCE<sup>(1)</sup></b>						
Resolution			16			Bits
Relative accuracy	Measured by line passing through codes 485 and 64714	DAC8560A, DAC8560C		$\pm 4$	$\pm 12$	LSB
		DAC8560B, DAC8560D		$\pm 4$	$\pm 8$	LSB
Differential nonlinearity		16-bit Monotonic		$\pm 0.5$	$\pm 1$	LSB
Zero-code error	Measured by line passing through codes 485 and 64714.			$\pm 5$	$\pm 12$	mV
Full-scale error			$\pm 0.2$	$\pm 0.5$	% of FSR	
Gain error			$\pm 0.05$	$\pm 0.2$	% of FSR	
Zero-code error drift				$\pm 4$		$\mu\text{V}/^{\circ}\text{C}$
Gain temperature coefficient	$V_{DD} = 5\text{ V}$			$\pm 1$		ppm of FSR/ $^{\circ}\text{C}$
	$V_{DD} = 2.7\text{ V}$			$\pm 3$		
PSRR	Power supply rejection ratio	Output unloaded		1		mV/V
<b>OUTPUT CHARACTERISTICS<sup>(2)</sup></b>						
Output voltage range			0		$V_{REF}$	V
Output voltage settling time	To $\pm 0.003\%$ FSR, 0200h to FD00h, $R_L = 2\text{ k}\Omega$ , $0\text{ pF} < C_L < 200\text{ pF}$			8	10	$\mu\text{s}$
	$R_L = 2\text{ k}\Omega$ , $C_L = 500\text{ pF}$			12		
Slew rate				1.8		V/ $\mu\text{s}$
Capacitive load stability	$R_L = \infty$			470		pF
	$R_L = 2\text{ k}\Omega$			1000		
Code change glitch impulse	1 LSB change around major carry			0.15		nV-s
Digital feedthrough	SCLK toggling, $\overline{\text{SYNC}}$ high			0.15		nV-s
DC output impedance	At mid-code input			1		$\Omega$
Short-circuit current	$V_{DD} = 5\text{ V}$			50		mA
	$V_{DD} = 3\text{ V}$			20		
Power-up time	Coming out of power-down mode $V_{DD} = 5\text{ V}$			2.5		$\mu\text{s}$
	Coming out of power-down mode $V_{DD} = 3\text{ V}$			5		
<b>AC PERFORMANCE<sup>(2)</sup></b>						
SNR				88		dB
THD	$T_A = 25^{\circ}\text{C}$ , BW = 20 kHz, $V_{DD} = 5\text{ V}$ , $f_{OUT} = 1\text{ kHz}$ , 1st 19 harmonics removed for SNR calculation			-77		dB
SFDR				79		dB
SINAD				77		dB
DAC output noise density			$T_A = 25^{\circ}\text{C}$ , at mid-code input, $f_{OUT} = 1\text{ kHz}$		170	
DAC output noise	$T_A = 25^{\circ}\text{C}$ , at mid-code input, 0.1 Hz to 10 Hz			50		$\mu\text{V}_{PP}$

(1) Linearity calculated using a reduced code range of 485 to 64714; output unloaded.

(2) Ensured by design and characterization, not production tested.

**Electrical Characteristics (continued)**
 $V_{DD} = 2.7\text{ V to }5.5\text{ V}$ ,  $-40^{\circ}\text{C to }+105^{\circ}\text{C}$  range (unless otherwise noted)

PARAMETER		TEST CONDITIONS	MIN	TYP	MAX	UNIT
<b>REFERENCE OUTPUT</b>						
Output voltage	$T_A = 25^{\circ}\text{C}$		2.4975	2.5	2.5025	V
Initial accuracy	$T_A = 25^{\circ}\text{C}$		-0.1%	$\pm 0.004\%$	0.1%	
Output voltage temperature drift	DAC8560A, DAC8560B <sup>(3)</sup>			5	25	ppm/ $^{\circ}\text{C}$
	DAC8560C, DAC8560D <sup>(4)</sup>			2	5	
Output voltage noise	$f = 0.1\text{ Hz to }10\text{ Hz}$			16		$\mu\text{V}_{PP}$
Output voltage noise density (high-frequency noise)	$T_A = 25^{\circ}\text{C}$ , $f = 1\text{ MHz}$ , $C_L = 0\text{ }\mu\text{F}$			125		nV/ $\sqrt{\text{Hz}}$
	$T_A = 25^{\circ}\text{C}$ , $f = 1\text{ MHz}$ , $C_L = 1\text{ }\mu\text{F}$			20		
	$T_A = 25^{\circ}\text{C}$ , $f = 1\text{ MHz}$ , $C_L = 4\text{ }\mu\text{F}$			2		
Load regulation, sourcing <sup>(5)</sup>	$T_A = 25^{\circ}\text{C}$			30		$\mu\text{V}/\text{mA}$
Load regulation, sinking <sup>(5)</sup>	$T_A = 25^{\circ}\text{C}$			15		$\mu\text{V}/\text{mA}$
Output current load capability <sup>(2)</sup>				$\pm 20$		mA
Line regulation	$T_A = 25^{\circ}\text{C}$			10		$\mu\text{V}/\text{V}$
Long-term stability/drift (aging) <sup>(5)</sup>	$T_A = 25^{\circ}\text{C}$ , time = 0 to 1900 hours			50		ppm
Thermal hysteresis <sup>(5)</sup>	First cycle			100		ppm
	Additional cycles			25		
<b>REFERENCE</b>						
Internal reference current consumption	$V_{DD} = 5.5\text{ V}$			360		$\mu\text{A}$
	$V_{DD} = 3.6\text{ V}$			348		
External reference current	External $V_{REF} = 2.5\text{ V}$ , if internal reference is disabled			20		$\mu\text{A}$
Reference input range			0		$V_{DD}$	V
Reference input impedance				125		k $\Omega$
<b>LOGIC INPUTS<sup>(2)</sup></b>						
Input current				$\pm 1$		$\mu\text{A}$
$V_{INL}$	Logic input LOW voltage	$V_{DD} = 5\text{ V}$			0.8	V
		$V_{DD} = 3\text{ V}$			0.6	
$V_{INH}$	Logic input HIGH voltage	$V_{DD} = 5\text{ V}$	2.4			V
		$V_{DD} = 3\text{ V}$	2.1			
Pin capacitance					3	pF
<b>POWER REQUIREMENTS</b>						
$V_{DD}$			2.7		5.5	V
$I_{DD}$ <sup>(6)</sup>	Normal mode	$V_{DD} = 3.6\text{ V to }5.5\text{ V}$ , $V_{IH} = V_{DD}$ and $V_{IL} = \text{GND}$		0.53	0.85	mA
		$V_{DD} = 2.7\text{ V to }3.6\text{ V}$ , $V_{IH} = V_{DD}$ and $V_{IL} = \text{GND}$		0.51	0.84	
	All power-down modes	$V_{DD} = 3.6\text{ V to }5.5\text{ V}$ , $V_{IH} = V_{DD}$ and $V_{IL} = \text{GND}$		1.2	2.5	$\mu\text{A}$
		$V_{DD} = 2.7\text{ V to }3.6\text{ V}$ , $V_{IH} = V_{DD}$ and $V_{IL} = \text{GND}$		0.7	2.2	
Power dissipation <sup>(6)</sup>	Normal mode	$V_{DD} = 3.6\text{ V to }5.5\text{ V}$		2.6	4.7	mW
		$V_{DD} = 2.7\text{ V to }3.6\text{ V}$		1.5	3	
	All power-down modes	$V_{DD} = 3.6\text{ V to }5.5\text{ V}$		6	14	$\mu\text{W}$
		$V_{DD} = 2.7\text{ V to }3.6\text{ V}$		2	8	
<b>TEMPERATURE RANGE</b>						
Specified performance			-40		105	$^{\circ}\text{C}$

(3) Reference is trimmed and tested at room temperature, and is characterized from  $-40^{\circ}\text{C}$  to  $+120^{\circ}\text{C}$ .

(4) Reference is trimmed and tested at two temperatures ( $25^{\circ}\text{C}$  and  $105^{\circ}\text{C}$ ), and is characterized from  $-40^{\circ}\text{C}$  to  $+120^{\circ}\text{C}$ .

(5) Explained in more detail in [Application and Implementation](#).

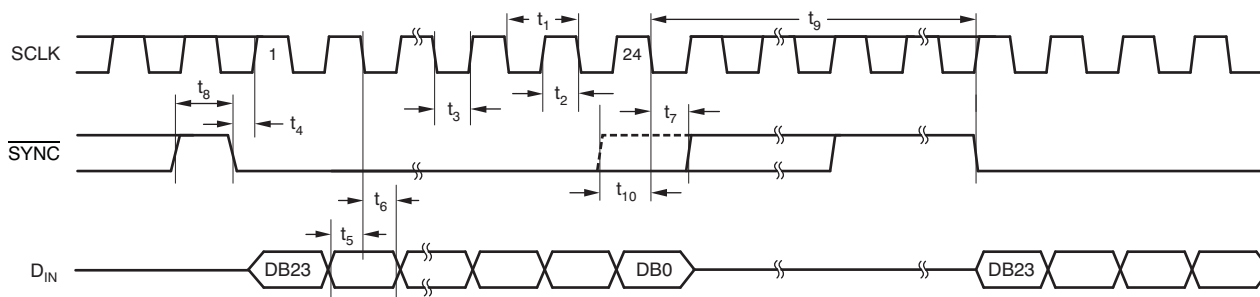
(6) Input code = 32768, reference current included, no load.

### 6.6 Timing Requirements

V<sub>DD</sub> = 2.7 V to 5.5 V, all specifications –40°C to +105°C (unless otherwise noted)<sup>(1) (2)</sup>

PARAMETER		MIN	NOM	MAX	UNIT
t <sub>1</sub> <sup>(3)</sup>	SCLK cycle time	V <sub>DD</sub> = 2.7 V to 3.6 V	50		ns
		V <sub>DD</sub> = 3.6 V to 5.5 V	33		
t <sub>2</sub>	SCLK HIGH time	V <sub>DD</sub> = 2.7 V to 3.6 V	13		ns
		V <sub>DD</sub> = 3.6 V to 5.5 V	13		
t <sub>3</sub>	SCLK LOW time	V <sub>DD</sub> = 2.7 V to 3.6 V	22.5		ns
		V <sub>DD</sub> = 3.6 V to 5.5 V	13		
t <sub>4</sub>	$\overline{\text{SYNC}}$ to SCLK rising edge setup time	V <sub>DD</sub> = 2.7 V to 3.6 V	0		ns
		V <sub>DD</sub> = 3.6 V to 5.5 V	0		
t <sub>5</sub>	Data setup time	V <sub>DD</sub> = 2.7 V to 3.6 V	5		ns
		V <sub>DD</sub> = 3.6 V to 5.5 V	5		
t <sub>6</sub>	Data hold time	V <sub>DD</sub> = 2.7 V to 3.6 V	4.5		ns
		V <sub>DD</sub> = 3.6 V to 5.5 V	4.5		
t <sub>7</sub>	SCLK falling edge to $\overline{\text{SYNC}}$ rising edge	V <sub>DD</sub> = 2.7 V to 3.6 V	0		ns
		V <sub>DD</sub> = 3.6 V to 5.5 V	0		
t <sub>8</sub>	Minimum $\overline{\text{SYNC}}$ HIGH time	V <sub>DD</sub> = 2.7 V to 3.6 V	50		ns
		V <sub>DD</sub> = 3.6 V to 5.5 V	33		
t <sub>9</sub>	24th SCLK falling edge to $\overline{\text{SYNC}}$ falling edge	V <sub>DD</sub> = 2.7 V to 3.6 V	100		ns
		V <sub>DD</sub> = 3.6 V to 5.5 V	100		
t <sub>10</sub>	$\overline{\text{SYNC}}$ rising edge to 24th SCLK falling edge (for successful SYNC interrupt)	V <sub>DD</sub> = 2.7 V to 3.6 V	15		ns
		V <sub>DD</sub> = 3.6 V to 5.5 V	15		

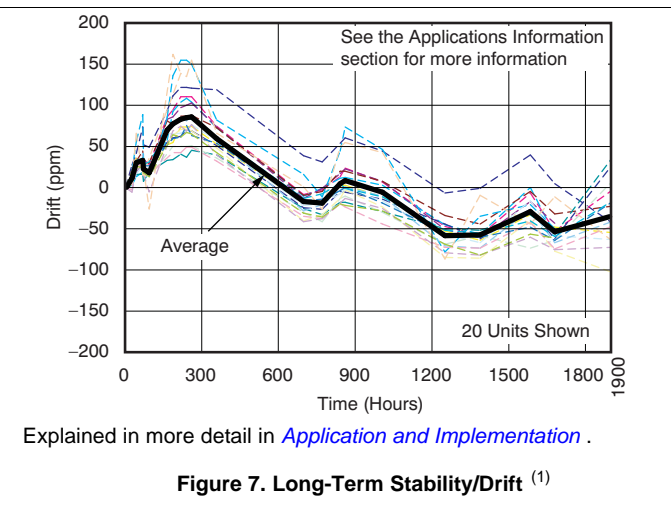
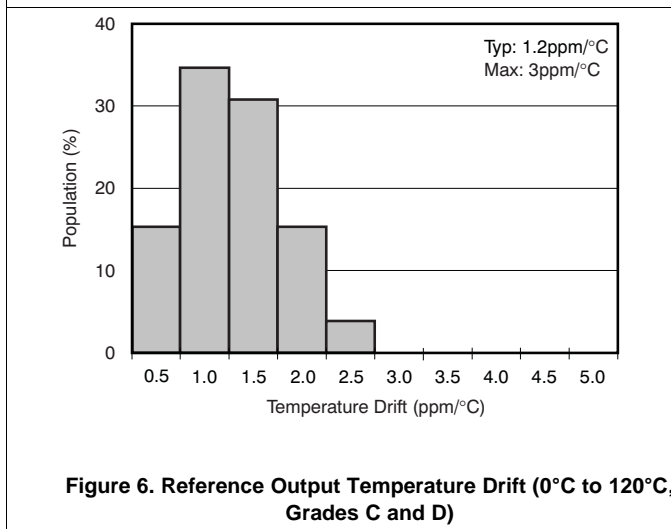
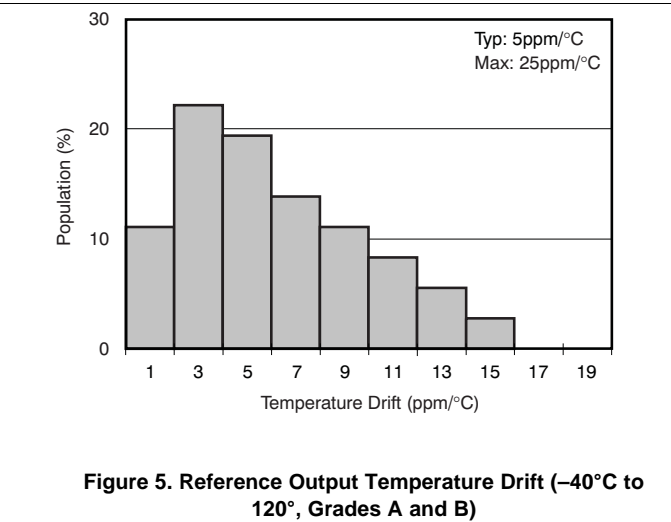
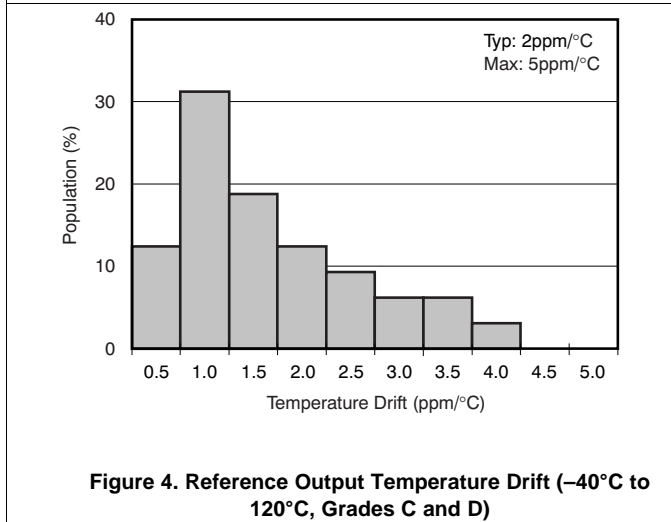
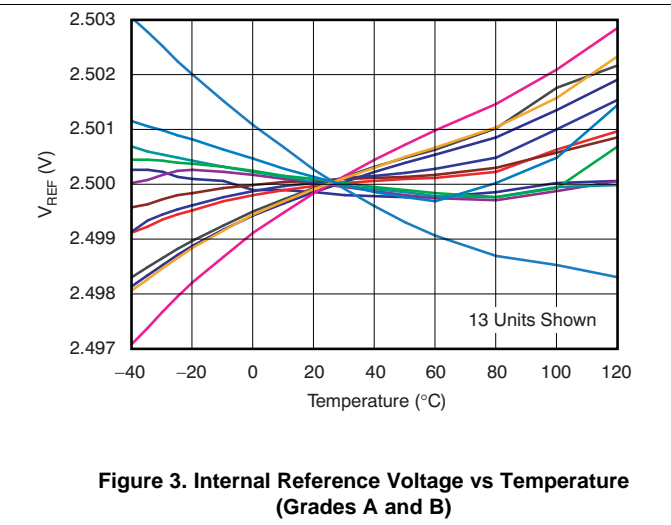
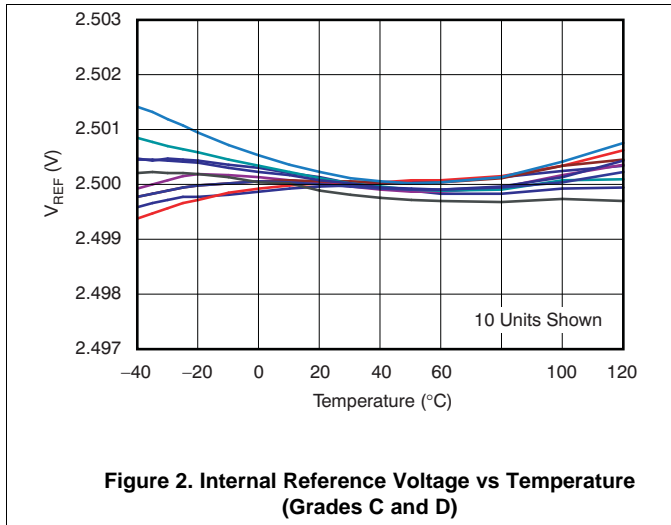
- (1) All input signals are specified with t<sub>R</sub> = t<sub>F</sub> = 3 ns (10% to 90% of V<sub>DD</sub>) and timed from a voltage level of (V<sub>IL</sub> + V<sub>IH</sub>) / 2.
- (2) See Figure 1.
- (3) Maximum SCLK frequency is 3 0MHz at V<sub>DD</sub> = 3.6 V to 5.5 V and 20 MHz at V<sub>DD</sub> = 2.7 V to 3.6 V.



**Figure 1. Serial Write Operation**

### 6.7 Typical Characteristics: Internal Reference

At  $T_A = 25^\circ\text{C}$ , unless otherwise noted.

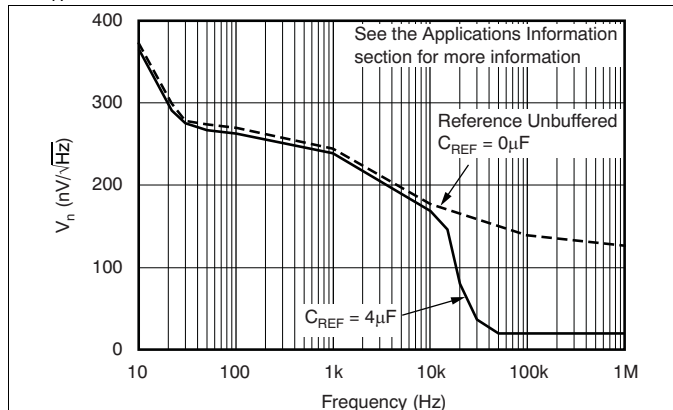


(1)



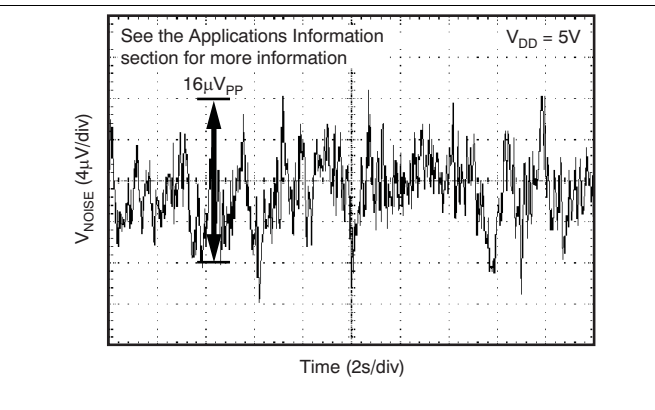
Typical Characteristics: Internal Reference (continued)

At  $T_A = 25^\circ\text{C}$ , unless otherwise noted.



Explained in more detail in [Application and Implementation](#).

Figure 8. Internal Reference Noise Density vs Frequency



Explained in more detail in [Application and Implementation](#).

Figure 9. Internal Reference Noise 0.1 Hz to 10 Hz

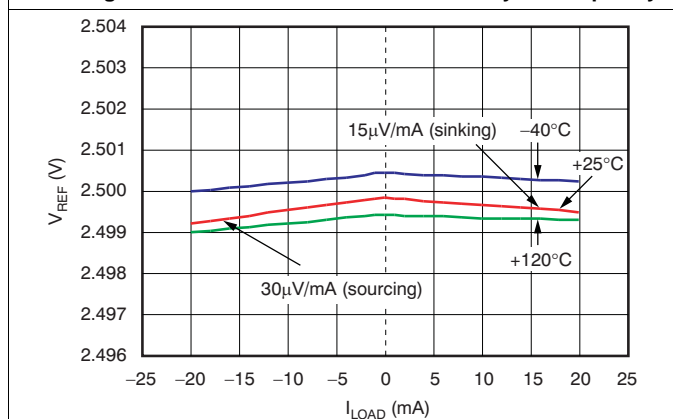


Figure 10. Internal Reference Voltage vs Load Current (Grades C and D)

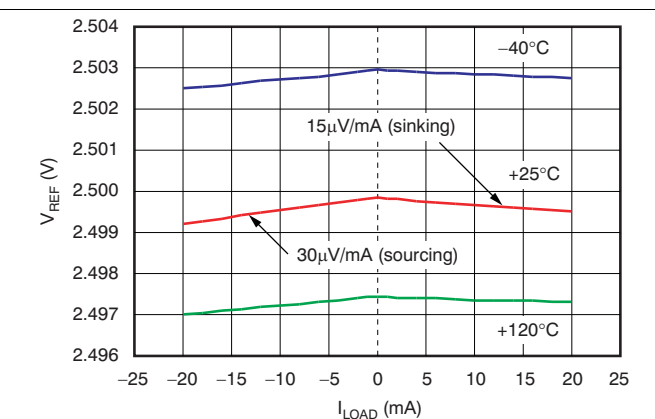


Figure 11. Internal Reference Voltage vs Load Current (Grades A and B)

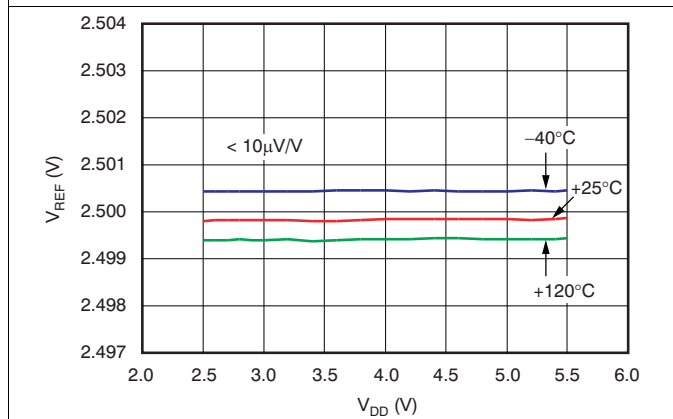


Figure 12. Internal Reference Voltage vs Supply Voltage (Grades C and D)

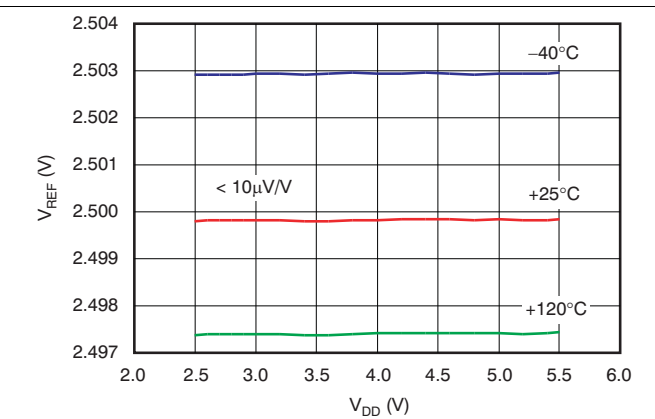


Figure 13. Internal Reference Voltage vs Supply Voltage (Grades A and B)

### 6.8 Typical Characteristics: DAC at $V_{DD} = 5\text{ V}$

At  $T_A = 25^\circ\text{C}$ , external reference used, and DAC output not loaded, unless otherwise noted.

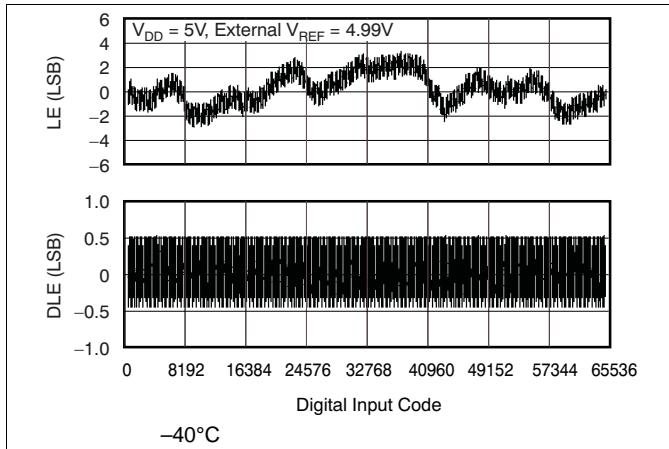


Figure 14. Linearity Error and Differential Linearity Error vs Digital Input Code

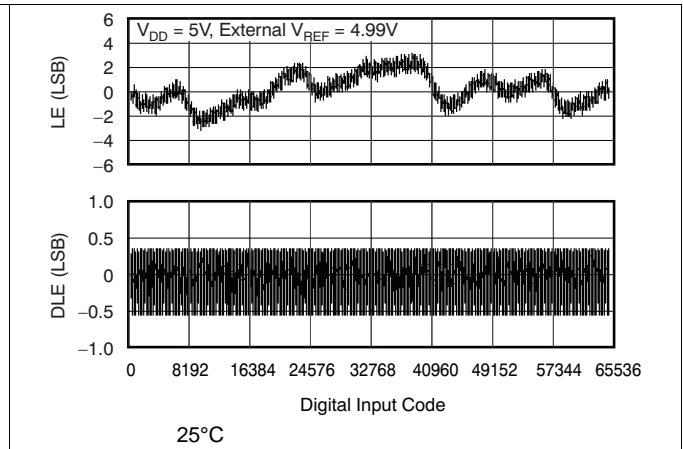


Figure 15. Linearity Error and Differential Linearity Error vs Digital Input Code

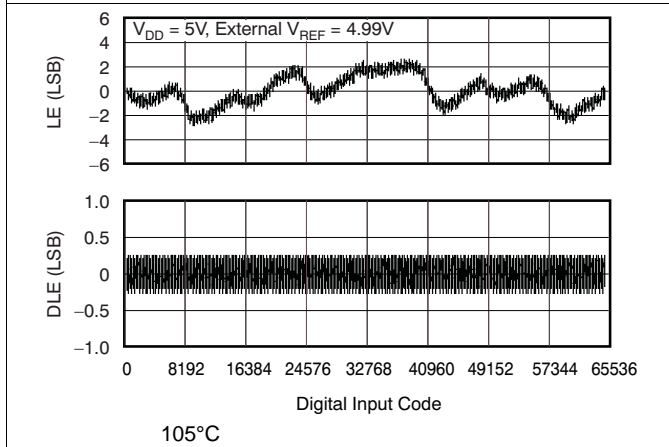


Figure 16. Linearity Error and Differential Linearity Error vs Digital Input Code

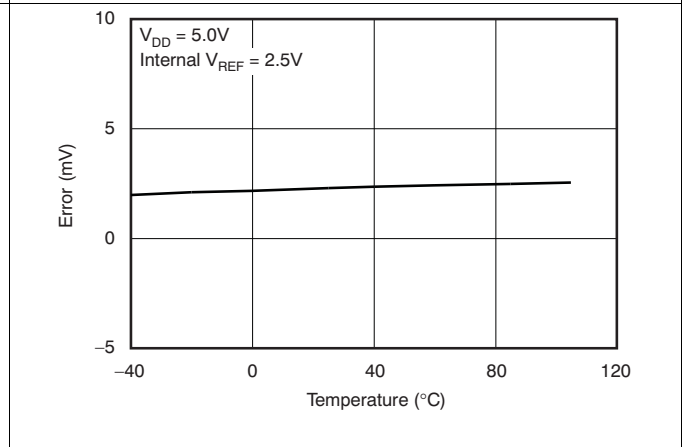


Figure 17. Zero-Scale Error vs Temperature

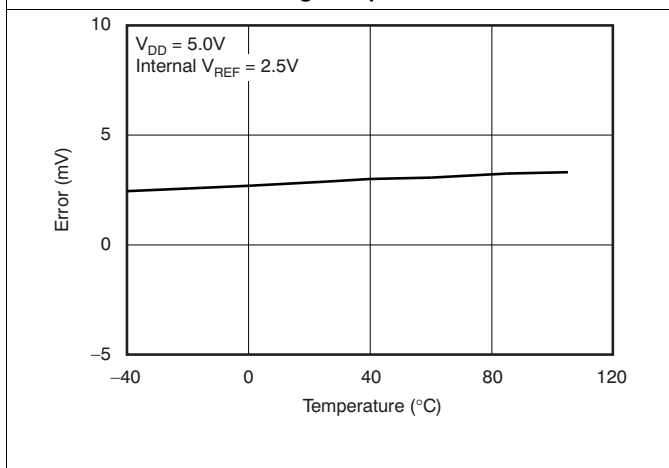


Figure 18. Full-Scale Error vs Temperature

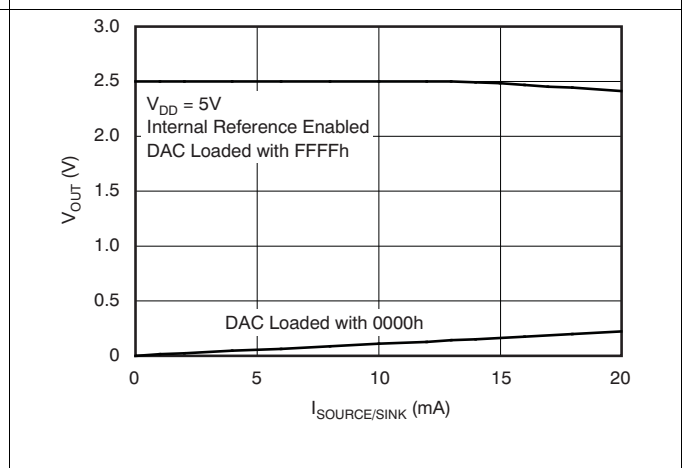
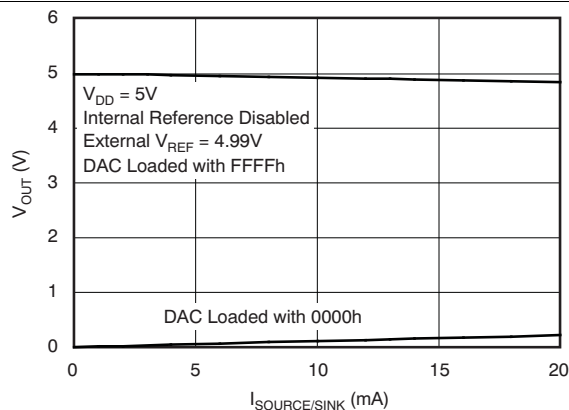


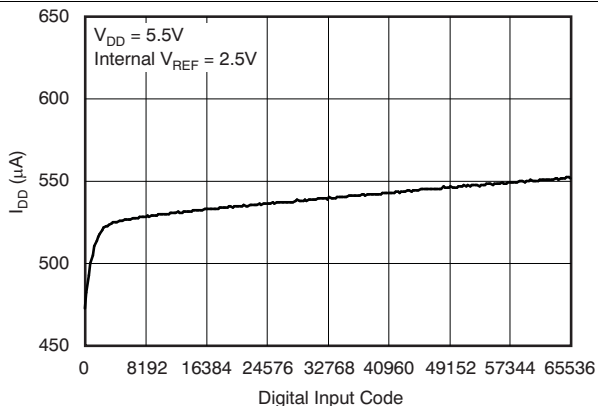
Figure 19. Source and Sink Current Capability

**Typical Characteristics: DAC at  $V_{DD} = 5\text{ V}$  (continued)**

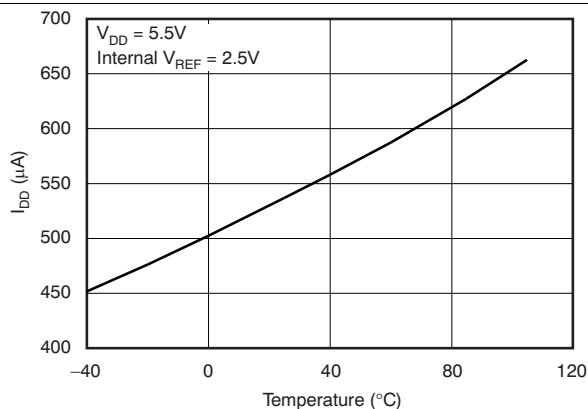
At  $T_A = 25^\circ\text{C}$ , external reference used, and DAC output not loaded, unless otherwise noted.



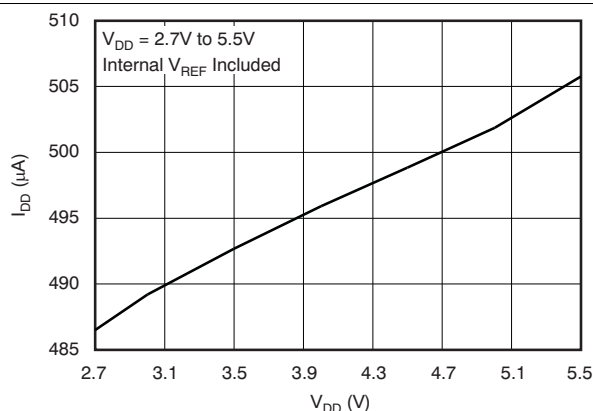
**Figure 20. Source and Sink Current Capability**



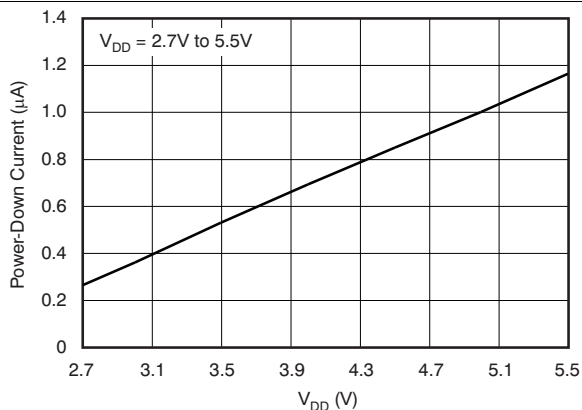
**Figure 21. Power-Supply Current vs Digital Input Code**



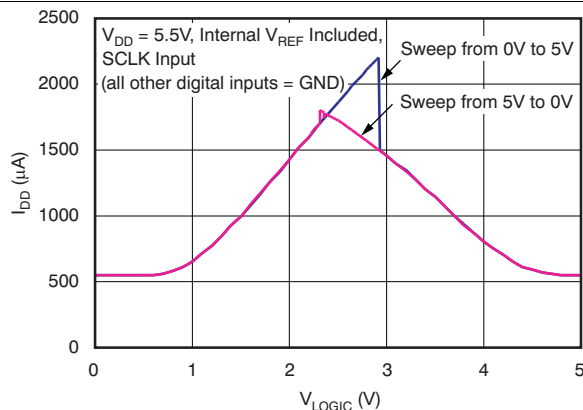
**Figure 22. Power-Supply Current vs Temperature**



**Figure 23. Power-Supply Current vs Power-Supply Voltage**



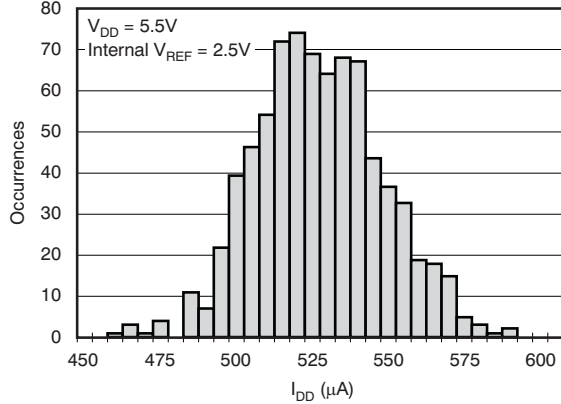
**Figure 24. Power-Down Current vs Power-Supply Voltage**



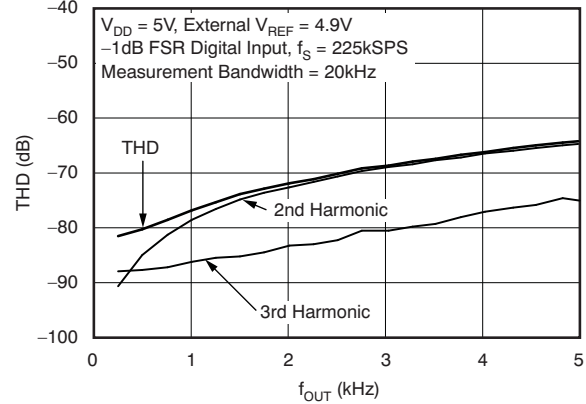
**Figure 25. Power-Supply Current vs Logic Input Voltage**

**Typical Characteristics: DAC at  $V_{DD} = 5\text{ V}$  (continued)**

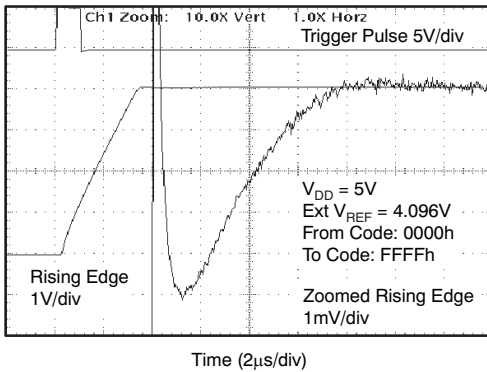
At  $T_A = 25^\circ\text{C}$ , external reference used, and DAC output not loaded, unless otherwise noted.



**Figure 26. Power-Supply Current Histogram**

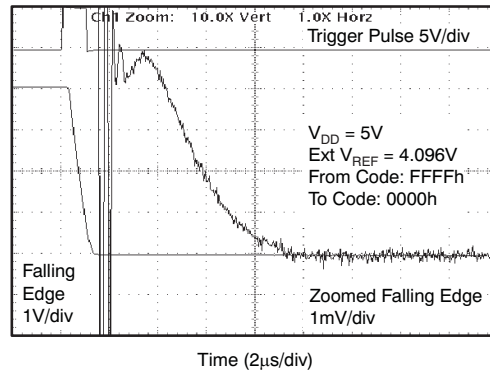


**Figure 27. Total Harmonic Distortion vs Output Frequency**



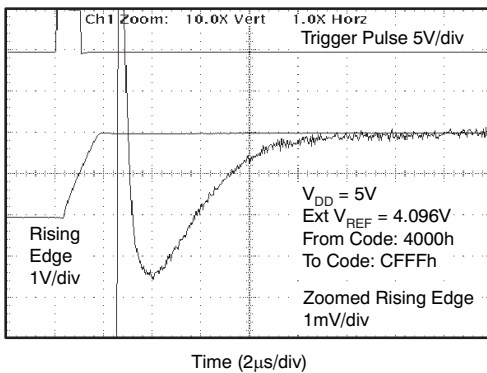
5-V Rising Edge

**Figure 28. Full-Scale Settling Time**



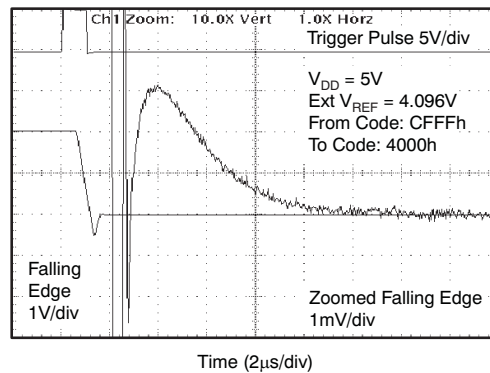
5-V Falling Edge

**Figure 29. Full-Scale Settling Time**



5-V Rising Edge

**Figure 30. Half-Scale Settling Time**

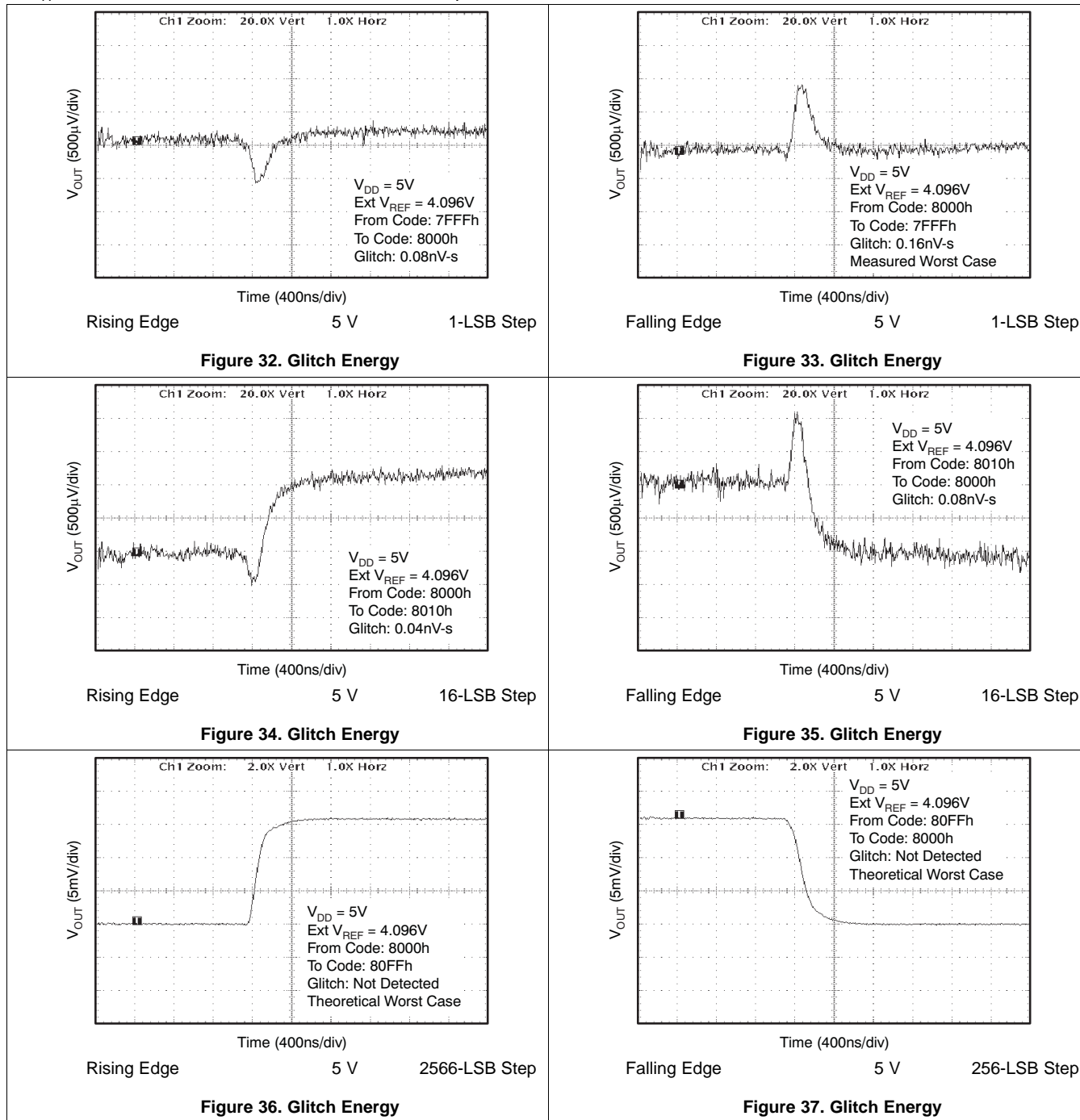


5-V Falling Edge

**Figure 31. Half-Scale Settling Time**

Typical Characteristics: DAC at  $V_{DD} = 5\text{ V}$  (continued)

At  $T_A = 25^\circ\text{C}$ , external reference used, and DAC output not loaded, unless otherwise noted.



Typical Characteristics: DAC at  $V_{DD} = 5\text{ V}$  (continued)

At  $T_A = 25^\circ\text{C}$ , external reference used, and DAC output not loaded, unless otherwise noted.

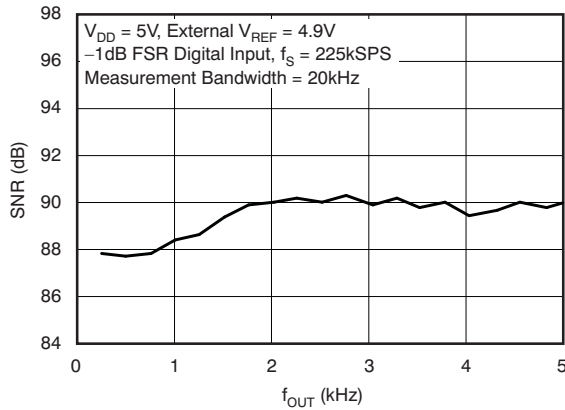


Figure 38. Signal-to-Noise Ratio vs Output Frequency

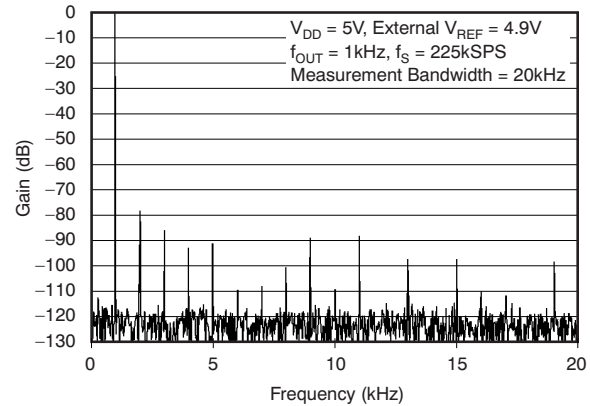
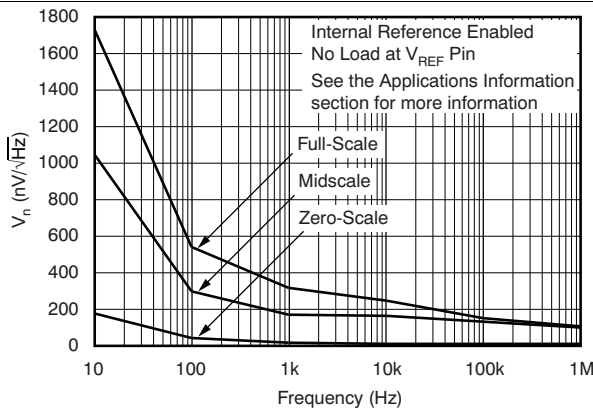
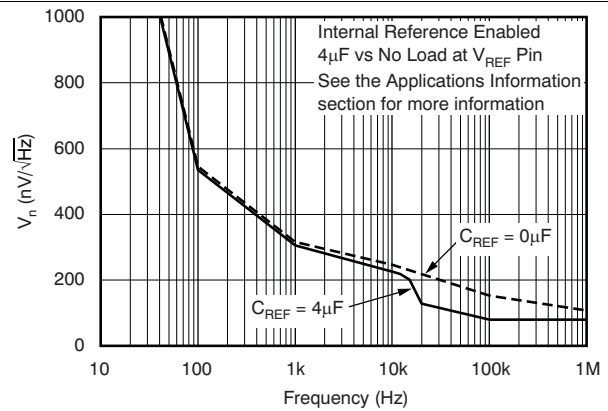


Figure 39. Power Spectral Density



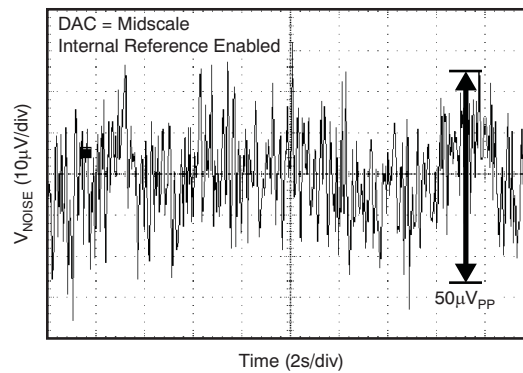
Explained in more detail in [Application and Implementation](#).

Figure 40. DAC Output Noise Density vs Frequency



Explained in more detail in the [Application and Implementation](#)

Figure 41. DAC Output Noise Density vs Frequency

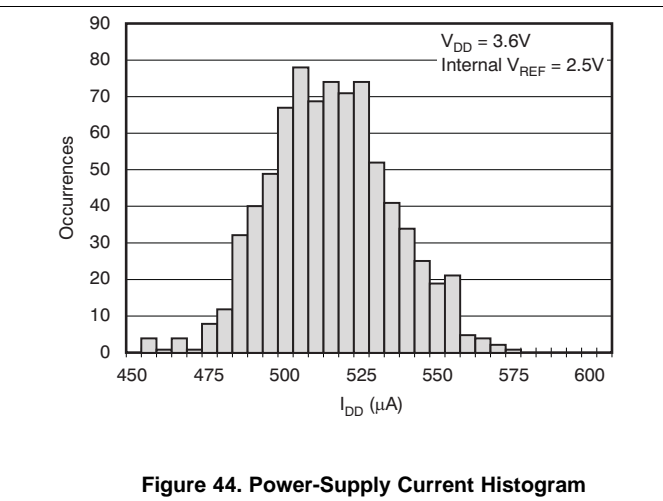
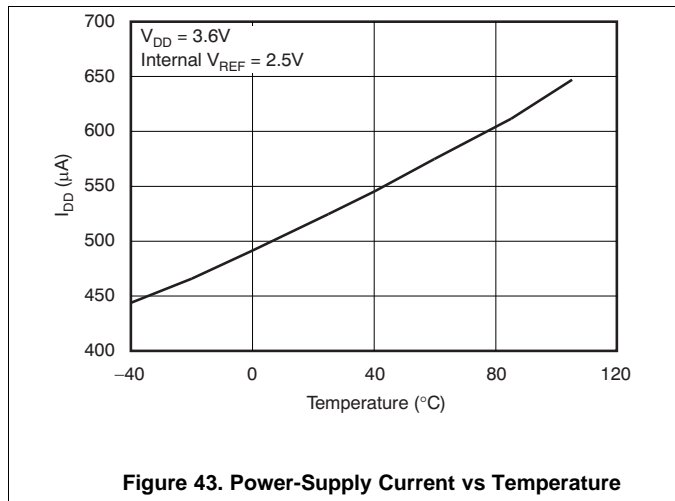


0.1 Hz to 10 Hz

Figure 42. DAC Output Noise

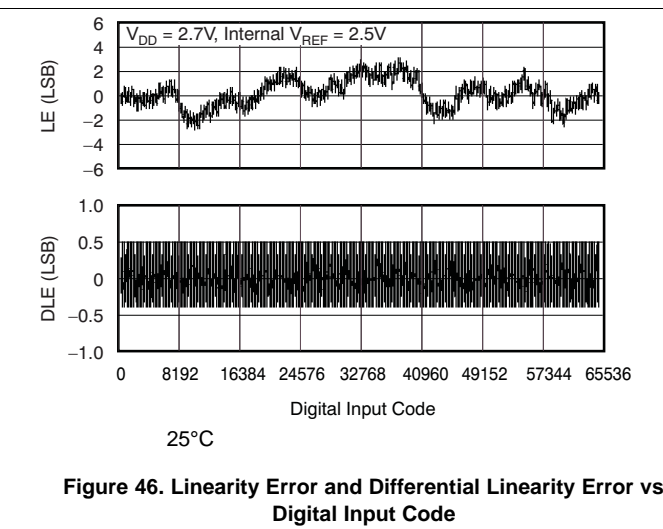
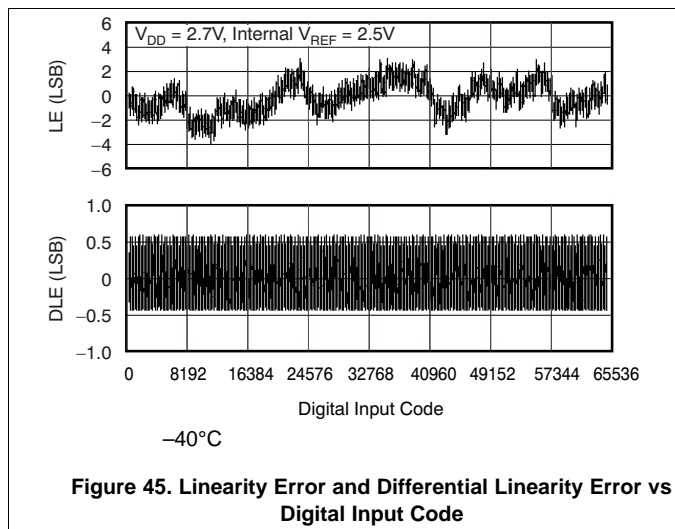
### 6.9 Typical Characteristics: DAC at $V_{DD} = 3.6\text{ V}$

At  $T_A = 25^\circ\text{C}$ , internal reference used, and DAC output not loaded, unless otherwise noted



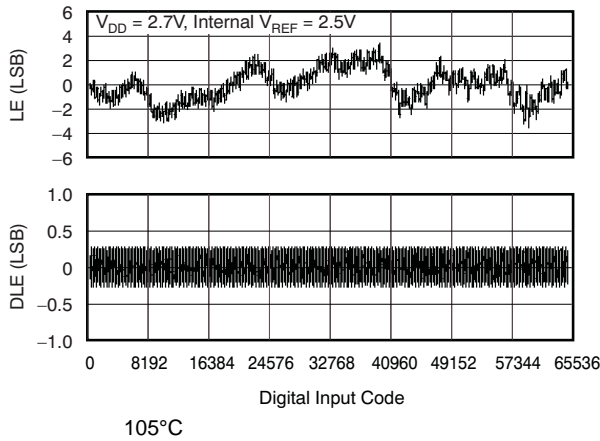
### 6.10 Typical Characteristics: DAC at $V_{DD} = 2.7\text{ V}$

At  $T_A = 25^\circ\text{C}$ , internal reference used, and DAC output not loaded, unless otherwise noted

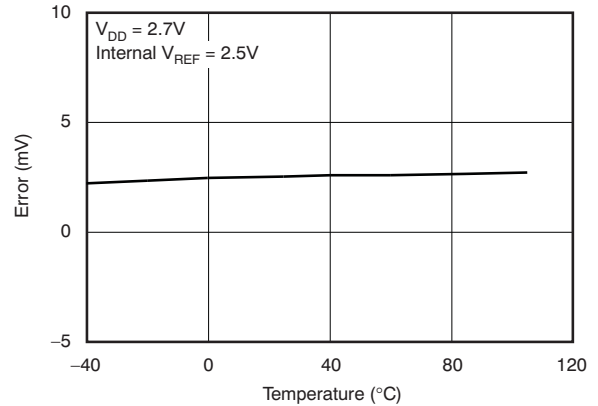


**Typical Characteristics: DAC at  $V_{DD} = 2.7\text{ V}$  (continued)**

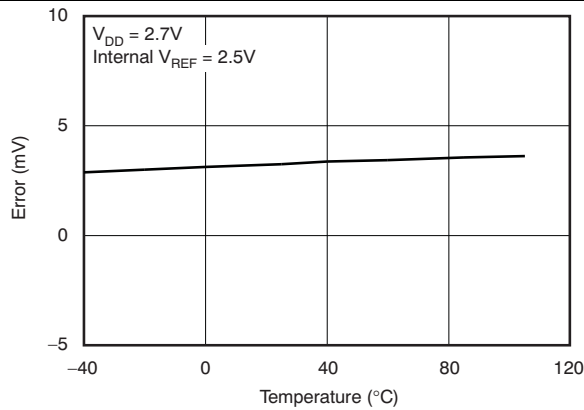
At  $T_A = 25^\circ\text{C}$ , internal reference used, and DAC output not loaded, unless otherwise noted



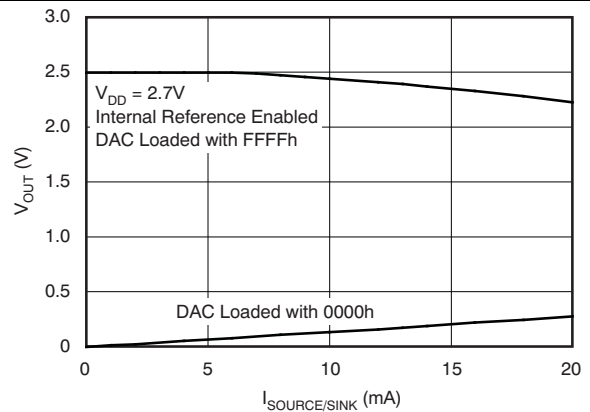
**Figure 47. Linearity Error and Differential Linearity Error vs Digital Input Code**



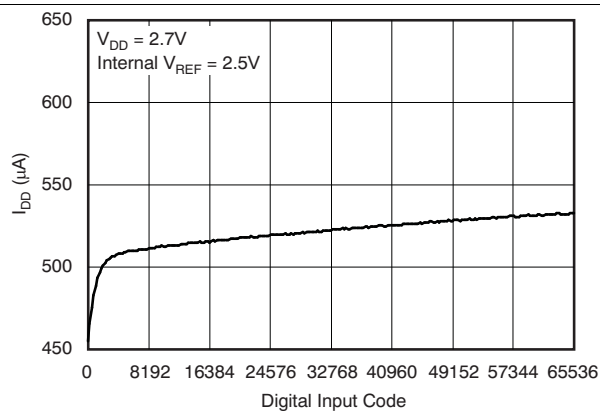
**Figure 48. Zero-Scale Error vs Temperature**



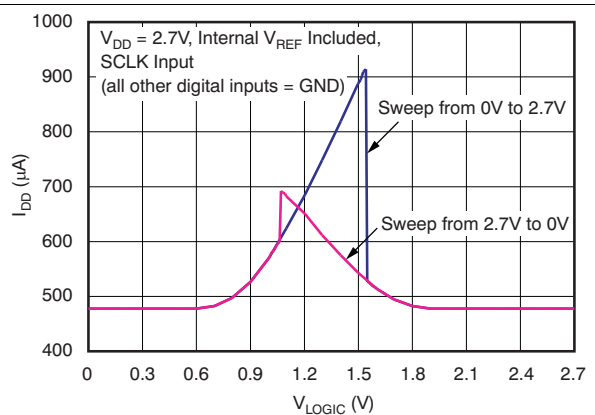
**Figure 49. Full-Scale Error vs Temperature**



**Figure 50. Source and Sink Current Capability**



**Figure 51. Supply Current vs Digital Input Code**

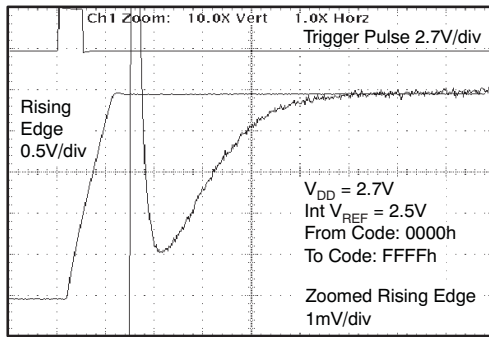


**Figure 52. Power-Supply Current vs Logic Input Voltage**



Typical Characteristics: DAC at  $V_{DD} = 2.7\text{ V}$  (continued)

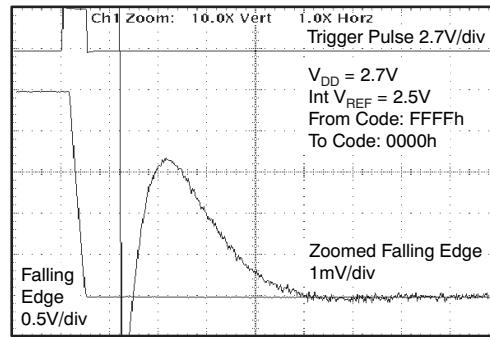
At  $T_A = 25^\circ\text{C}$ , internal reference used, and DAC output not loaded, unless otherwise noted



Time (2µs/div)

2.7-V Rising Edge

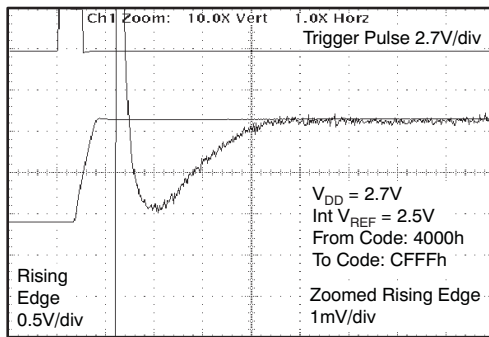
Figure 53. Full-Scale Settling Time



Time (2µs/div)

2.7-V Falling Edge

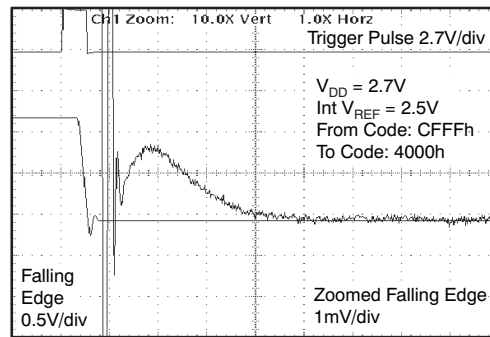
Figure 54. Full-Scale Settling Time: 2.7-V Falling Edge



Time (2µs/div)

2.7-V Rising Edge

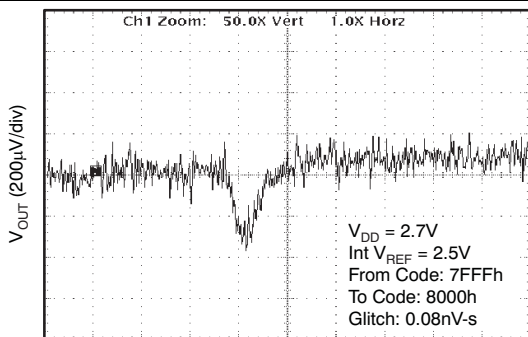
Figure 55. Half-Scale Settling Time



Time (2µs/div)

2.7-V Falling Edge

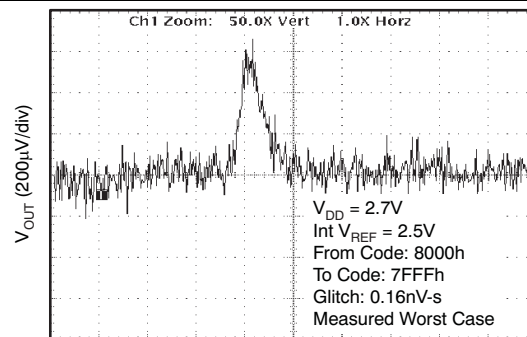
Figure 56. Half-Scale Settling Time



Time (400ns/div)

Rising Edge 2.7 V 1-LSB Step

Figure 57. Glitch Energy



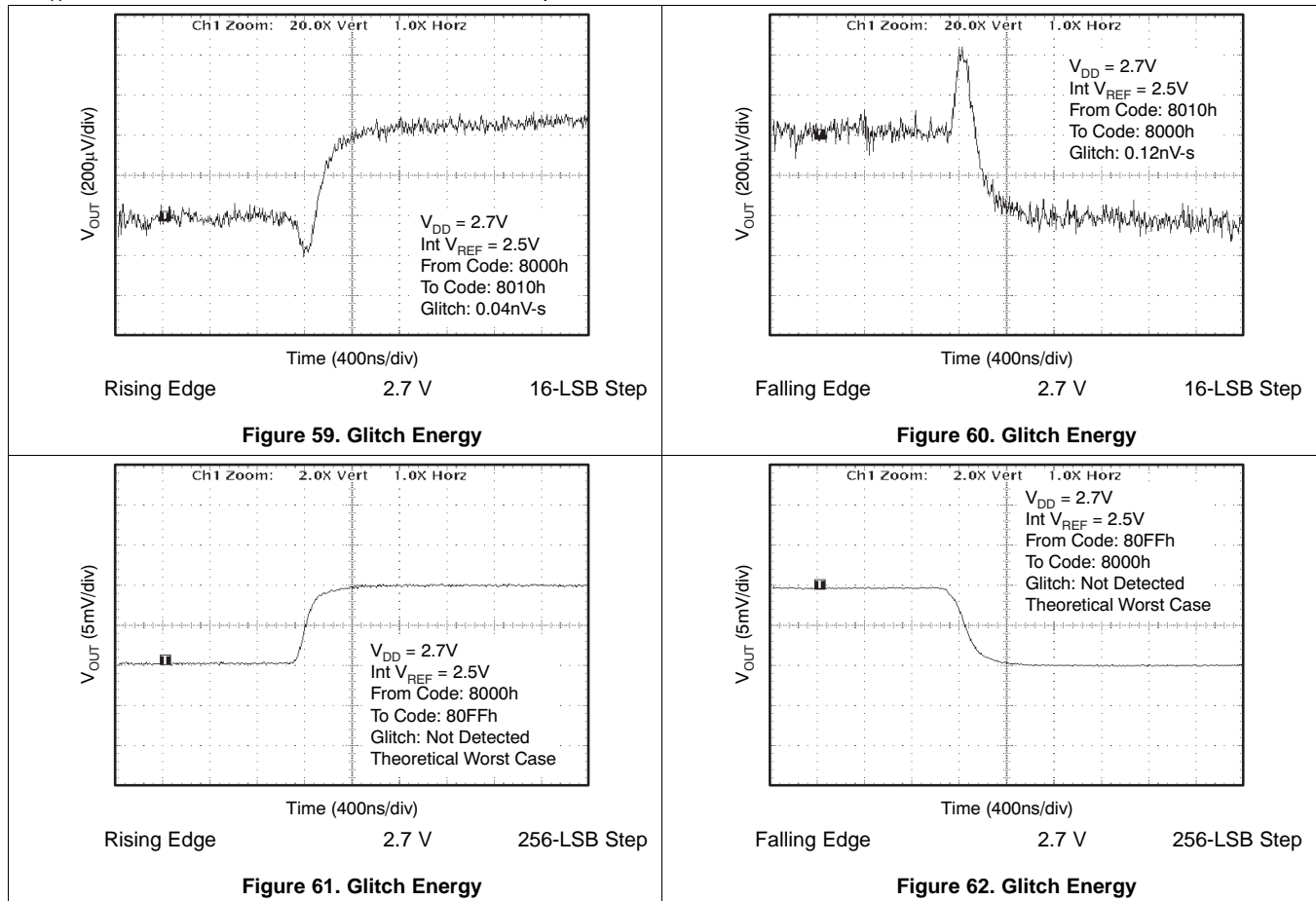
Time (400ns/div)

Falling Edge 2.7 V 1-LSB Step

Figure 58. Glitch Energy

**Typical Characteristics: DAC at  $V_{DD} = 2.7\text{ V}$  (continued)**

At  $T_A = 25^\circ\text{C}$ , internal reference used, and DAC output not loaded, unless otherwise noted

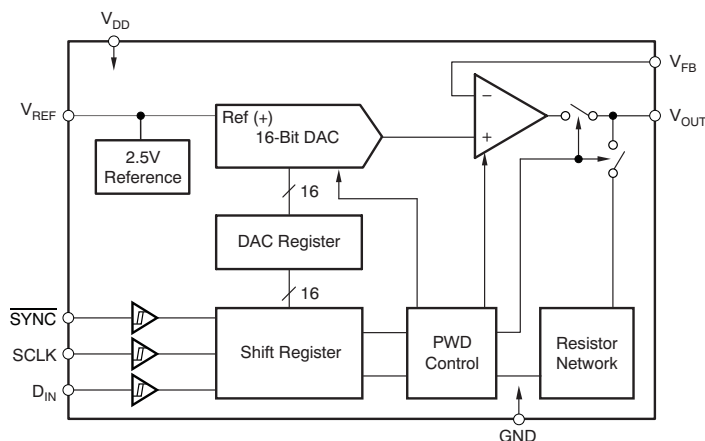


## 7 Detailed Description

### 7.1 Overview

The DAC8560 is a low-power, voltage output, 16-bit digital-to-analog converter (DAC). The DAC8560 includes a 2.5-V, 2-ppm/°C internal reference (enabled by default), giving a full-scale output voltage range of 2.5 V. The internal reference has an initial accuracy of 0.02% and can source up to 20 mA at the  $V_{REF}$  pin. The device is monotonic, provides very good linearity, and minimizes undesired code-to-code transient voltages (glitch). The DAC8560 uses a versatile 3-wire serial interface that operates at clock rates up to 30 MHz. It is compatible with standard SPI, QSPI, Microwire, and digital-signal-processor (DSP) interfaces.

### 7.2 Functional Block Diagram



### 7.3 Feature Description

#### 7.3.1 Digital-to-Analog Converter (DAC)

The DAC8560 architecture consists of a string DAC followed by an output buffer amplifier. Figure 63 shows a block diagram of the DAC architecture.

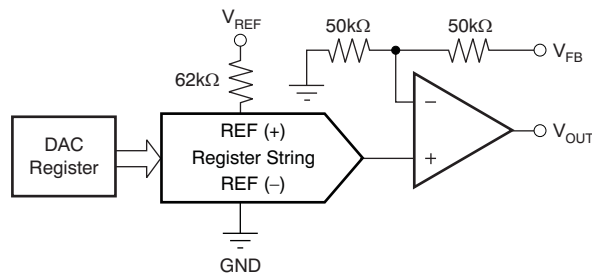


Figure 63. DAC8560 Architecture

The input coding to the DAC8560 is straight binary, so the ideal output voltage is given by:

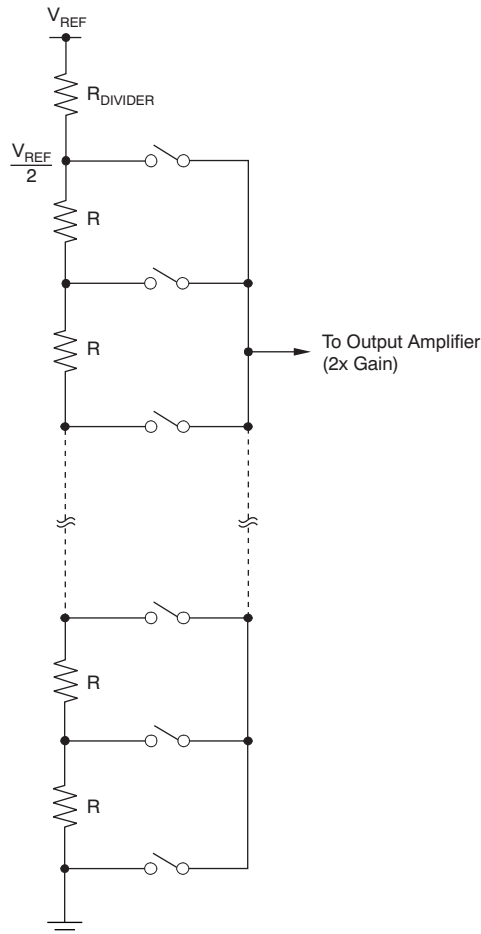
$$V_{OUT} = \frac{D_{IN}}{65536} \times V_{REF}$$

where  $D_{IN}$  = decimal equivalent of the binary code that is loaded to the DAC register; it can range from 0 to 65535. (1)

## Feature Description (continued)

### 7.3.2 Resistor String

The resistor string section is shown in [Figure 64](#). It is simply a string of resistors, each of value  $R$ . The code loaded into the DAC register determines at which node on the string the voltage is tapped off to be fed into the output amplifier by closing one of the switches connecting the string to the amplifier. It is monotonic because it is a string of resistors.



**Figure 64. Resistor String**

### 7.3.3 Output Amplifier

The output buffer amplifier is capable of generating rail-to-rail voltages on its output, giving an output range of 0 V to  $V_{DD}$ . It is capable of driving a load of 2 k $\Omega$  in parallel with 1000 pF to GND. The source and sink capabilities of the output amplifier can be seen in the [Typical Characteristics: DAC at  \$V\_{DD} = 5\$  V](#). The slew rate is 1.8 V/ $\mu$ s with a full-scale settling time of 8  $\mu$ s with the output unloaded.

The inverting input of the output amplifier is available at the  $V_{FB}$  pin. This feature allows better accuracy in critical applications by tying the  $V_{FB}$  point and the amplifier output together directly at the load. Other signal conditioning circuitry may also be connected between these points for specific applications.

## Feature Description (continued)

### 7.3.4 DAC Noise Performance

Typical noise performance for the DAC8560 with the internal reference enabled is shown in Figure 40 to Figure 42. Output noise spectral density at pin  $V_{OUT}$  versus frequency is depicted in Figure 40 for full-scale, midscale, and zero-scale input codes. The typical noise density for midscale code is 170 nV/ $\sqrt{\text{Hz}}$  at 1 kHz and 100nV/ $\sqrt{\text{Hz}}$  at 1MHz. High-frequency noise can be improved by filtering the reference noise as shown in Figure 41, where a 4- $\mu\text{F}$  load capacitor is connected to the  $V_{REF}$  pin and compared to the no-load condition. Integrated output noise between 0.1 Hz and 10 Hz is close to 50  $\mu\text{V}_{PP}$  (midscale), as shown in Figure 42.

### 7.3.5 Internal Reference

The DAC8560 includes a 2.5-V internal reference that is enabled by default. The internal reference is externally available at the  $V_{REF}$  pin. TI recommends a minimum 100-nF capacitor between the reference output and GND for noise filtering.

The internal reference of the DAC8560 is a bipolar transistor-based, precision bandgap voltage reference. The basic bandgap topology is shown in Figure 65. Transistors  $Q_1$  and  $Q_2$  are biased such that the current density of  $Q_1$  is greater than that of  $Q_2$ . The difference of the two base-emitter voltages ( $V_{BE1} - V_{BE2}$ ) has a positive temperature coefficient and is forced across resistor  $R_1$ . This voltage is gained up and added to the base-emitter voltage of  $Q_2$ , which has a negative temperature coefficient. The resulting output voltage is virtually independent of temperature. The short-circuit current is limited by design to approximately 100 mA.

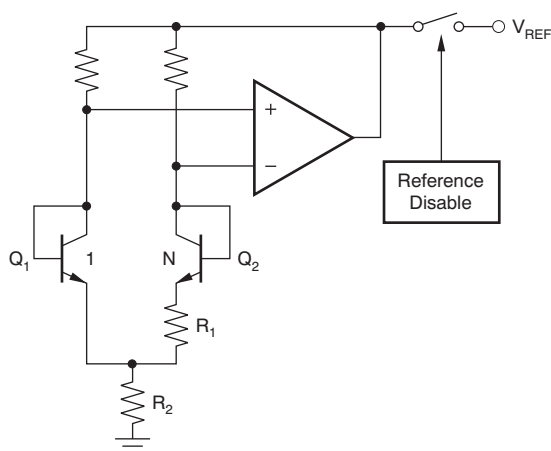


Figure 65. Simplified Schematic of the Bandgap Reference

#### 7.3.5.1 Enable/Disable Internal Reference

The DAC8560 internal reference is enabled by default; however, the reference can be disabled for debugging or evaluation purposes. A serial command requiring at least two additional SCLK cycles at the end of the 24-bit write sequence (see [Serial Interface](#)) must be used to disable the internal reference. For proper operation, a total of at least 26 SCLK cycles are required for each enable/disable internal reference update sequence, during which  $\overline{\text{SYNC}}$  must be held low. To disable the internal reference, execute the write sequence illustrated in [Table 2](#) followed by at least two additional SCLK falling edges while  $\overline{\text{SYNC}}$  is low.

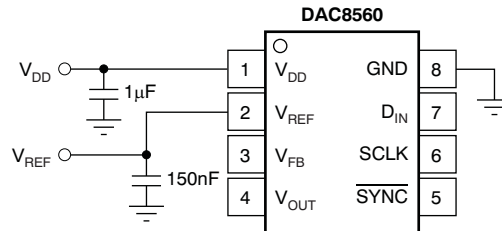
To then enable the reference, either perform a power-cycle to reset the device, or sequentially execute the two write sequences in [Table 3](#) and [Table 4](#). Each of these write sequences must be followed by at least two additional SCLK falling edges while  $\overline{\text{SYNC}}$  remains low.

During the time that the internal reference is disabled, the DAC will function normally using an external reference. At this point, the internal reference is disconnected from the  $V_{REF}$  pin (tri-state). Do not attempt to drive the  $V_{REF}$  pin externally and internally at the same time indefinitely.

## Feature Description (continued)

### 7.3.5.2 Internal Reference Load

The DAC8560 internal reference does not require an external load capacitor for stability because it is stable with any capacitive load. However, for improved noise performance, TI recommends an external load capacitor of 150 nF or larger connected to the  $V_{REF}$  output. [Figure 66](#) shows the typical connections required for operation of the DAC8560 internal reference. A supply bypass capacitor at the  $V_{DD}$  input is also recommended.



**Figure 66. Typical Connections for Operating the DAC8560 Internal Reference**

#### 7.3.5.2.1 Supply Voltage

The DAC8560 internal reference features an extremely low dropout voltage. It can be operated with a supply of only 5mV above the reference output voltage in an unloaded condition. For loaded conditions, refer to the [Load Regulation](#) section. The stability of the DAC8560 internal reference with variations in supply voltage (line regulation, DC PSRR) is also exceptional. Within the specified supply voltage range of 2.7 V to 5.5 V, the variation at  $V_{REF}$  is smaller than 10  $\mu\text{V/V}$ ; see the [Typical Characteristics: Internal Reference](#).

#### 7.3.5.2.2 Temperature Drift

The DAC8560 internal reference is designed to exhibit minimal drift error, defined as the change in reference output voltage over varying temperature. The drift is calculated using the *box* method, which is described by [Equation 2](#):

$$\text{Drift Error} = \left( \frac{V_{REF\_MAX} - V_{REF\_MIN}}{V_{REF} \times T_{RANGE}} \right) \times 10^6 \text{ (ppm/}^\circ\text{C)}$$

where

- $V_{REF\_MAX}$  = maximum reference voltage observed within temperature range  $T_{RANGE}$
  - $V_{REF\_MIN}$  = minimum reference voltage observed within temperature range  $T_{RANGE}$
  - $V_{REF} = 2.5 \text{ V}$ , target value for reference output voltage
- (2)

The DAC8560 internal reference (grades C and D) features an exceptional typical drift coefficient of 2 ppm/ $^\circ\text{C}$  from  $-40^\circ\text{C}$  to  $+120^\circ\text{C}$ . Characterizing a large number of units, a maximum drift coefficient of 5 ppm/ $^\circ\text{C}$  (grades C and D) is observed. Temperature drift results are summarized in the [Typical Characteristics: Internal Reference](#).

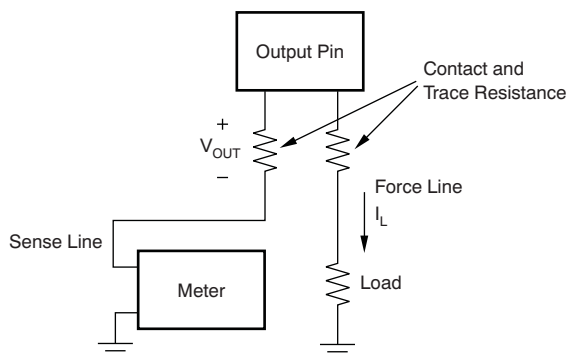
#### 7.3.5.2.3 Noise Performance

Typical 0.1-Hz to 10-Hz voltage noise can be seen in [Figure 9](#). Additional filtering can be used to improve output noise levels, although care should be taken to ensure the output impedance does not degrade the AC performance. The output noise spectrum at  $V_{REF}$  without any external components is depicted in [Figure 8, Internal Reference Noise Density vs Frequency](#). Another noise density spectrum is also shown in [Figure 8](#), which was obtained using a 4 $\mu\text{F}$  load capacitor at  $V_{REF}$  for noise filtering. Internal reference noise impacts the DAC output noise; see the [DAC Noise Performance](#) section for more details.

## Feature Description (continued)

### 7.3.5.2.4 Load Regulation

Load regulation is defined as the change in reference output voltage as a result of changes in load current. The load regulation of the DAC8560 internal reference is measured using force and sense contacts as pictured in [Figure 67](#). The force and sense lines reduce the impact of contact and trace resistance, resulting in accurate measurement of the load regulation contributed solely by the DAC8560 internal reference. Measurement results are summarized in the [Typical Characteristics: Internal Reference](#). Force and sense lines should be used for applications requiring improved load regulation.



**Figure 67. Accurate Load Regulation of the DAC8560 Internal Reference**

### 7.3.5.2.5 Long-Term Stability

Long-term stability/aging refers to the change of the output voltage of a reference over a period of months or years. This effect lessens as time progresses, as shown in [Figure 7](#), the typical long-term stability curve. The typical drift value for the DAC8560 internal reference is 50 ppm from 0 hours to 1900 hours. This parameter is characterized by powering up and measuring 20 units at regular intervals for a period of 1900 hours.

### 7.3.5.2.6 Thermal Hysteresis

Thermal hysteresis for a reference is defined as the change in output voltage after operating the device at 25°C, cycling the device through the specified temperature range, and returning to 25°C. It is expressed in [Equation 3](#):

$$V_{\text{HYST}} = \left( \frac{|V_{\text{REF\_PRE}} - V_{\text{REF\_POST}}|}{V_{\text{REF\_NOM}}} \right) \times 10^6 \text{ (ppm)}$$

where

- $V_{\text{HYST}}$  = thermal hysteresis
- $V_{\text{REF\_PRE}}$  = output voltage measured at 25°C pre-temperature cycling
- $V_{\text{REF\_POST}}$  = output voltage measured after the device has been cycled through the temperature range of –40°C to +120°C, and returned to 25°C (3)

## 7.4 Device Functional Modes

### 7.4.1 Power-Down Modes

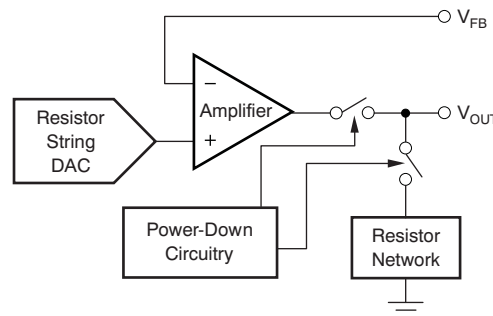
The DAC8560 supports four separate modes of operation. These modes are programmable by setting two bits (PD1 and PD0) in the control register. Table 1 shows how to control the operating mode with data bits PD1 (DB17) and PD0 (DB16).

**Table 1. Operating Modes**

PD1 (DB17)	PD0 (DB16)	OPERATING MODE
0	0	Normal operation
0	1	Power-down 1 kΩ to GND
1	0	Power-down 100 kΩ to GND
1	1	Power-down High-Z

When both bits are set to 0, the device works normally with its typical current consumption of 530 μA at 5.5 V. However, for the three power-down modes, the supply current falls to 1.2 μA at 5.5 V (0.7 μA at 3.6 V). Not only does the supply current fall, but the output stage is also internally switched from the output of the amplifier to a resistor network of known values.

The advantage of this switching is that the output impedance of the device is known while it is in power-down mode. As shown in Table 1, there are three different power-down options. V<sub>OUT</sub> can be connected internally to GND through a 1-kΩ resistor, a 100-kΩ resistor, or open-circuited (High-Z). The output stage is shown in Figure 68.



**Figure 68. Output Stage During Power Down**

All analog circuitry is shut down when the power-down mode is activated. However, the contents of the DAC register are unaffected when in power down. The time to exit power down is typically 2.5 μs for V<sub>DD</sub> = 5 V, and 5 μs for V<sub>DD</sub> = 3 V. See the *Typical Characteristics: DAC at V<sub>DD</sub> = 5 V* for more information.



## 7.5 Programming

### 7.5.1 Serial Interface

The DAC8560 has a 3-wire serial interface (  $\overline{\text{SYNC}}$ , SCLK, and  $\text{D}_{\text{IN}}$ ) that is compatible with SPI, QSPI, and Microwire interface standards, as well as most DSPs. See [Figure 1](#) for an example of a typical write sequence.

The write sequence begins by bringing the  $\overline{\text{SYNC}}$  line LOW. Data from the  $\text{D}_{\text{IN}}$  line is clocked into the 24-bit shift register on each falling edge of SCLK. The serial clock frequency can be as high as 30 MHz, making the DAC8560 compatible with high-speed DSPs. On the 24th falling edge of the serial clock, the last data bit is clocked in and the programmed function is executed.

At this point, the  $\overline{\text{SYNC}}$  line may be kept LOW or brought HIGH. In either case, it must be brought HIGH for a minimum of 33 ns before the next write sequence so that a falling edge of  $\overline{\text{SYNC}}$  can initiate the next write sequence. As previously mentioned, it must be brought HIGH again before the next write sequence.

### 7.5.2 Input Shift Register

The input shift register is 24 bits wide, as shown in [Table 5](#). The first six bits must be 000000. The next two bits (PD1 and PD0) are control bits that set the desired mode of operation (normal mode or any one of three power-down modes) as indicated in [Table 1](#).

A more complete description of the various modes is located in [Power-Down Modes](#). The next 16 bits are the data bits, which are transferred to the DAC register on the 24th falling edge of SCLK under normal operation (see [Table 1](#)).

### 7.5.3 $\overline{\text{SYNC}}$ Interrupt

In a normal write sequence, the  $\overline{\text{SYNC}}$  line is kept LOW for at least 24 falling edges of SCLK and the DAC is updated on the 24th falling edge. However, if  $\overline{\text{SYNC}}$  is brought HIGH before the 24th falling edge, it acts as an interrupt to the write sequence. The shift register is reset, and the write sequence is seen as invalid. Neither an update of the DAC register contents, nor a change in the operating mode occurs, as shown in [Figure 69](#).

### 7.5.4 Power-On Reset

The DAC8560 contains a power-on-reset circuit that controls the output voltage during power up. On power up, all registers are filled with zeros and the output voltage is zero-scale; it remains there until a valid write sequence is made to the DAC. This feature is useful in applications where it is important to know the state of the output of the DAC while it is in the process of powering up.

# DAC8560

## 7.6 Register Maps

### 7.6.1 Write Sequence for Disabling the DAC8560 Internal Reference

**Table 2. Write Sequence for Disabling the DAC8560 Internal Reference**

DB23																							DB0	
0	1	0	0	1	0	0	0	0	0	0	0	0	0	0	1	0	0	0	0	0	0	0	0	1

### 7.6.2 Enabling the DAC8560 Internal Reference (Write Sequence 1 of 2)

**Table 3. Enabling the DAC8560 Internal Reference (Write Sequence 1 of 2)**

DB23																							DB0
0	1	0	0	1	1	0	0	0	0	0	0	0	0	1	0	0	0	0	0	0	0	0	0

### 7.6.3 Enabling the DAC8560 Internal Reference (Write Sequence 2 of 2)

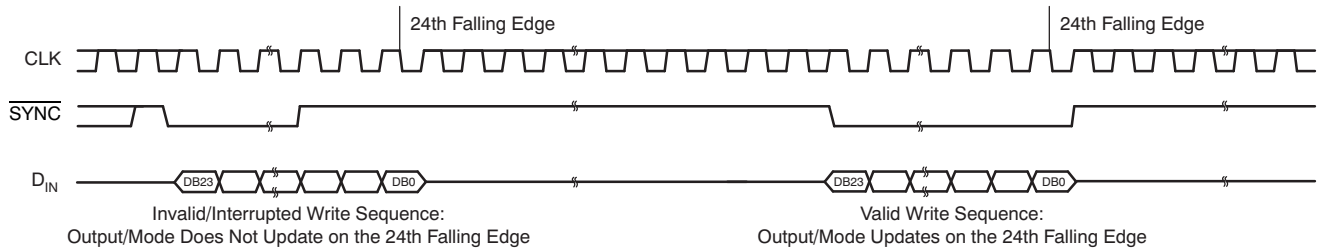
**Table 4. Enabling the DAC8560 Internal Reference (Write Sequence 2 of 2)**

DB23																							DB0
0	1	0	0	1	0	0	1	0	0	0	0	0	0	1	0	0	0	0	0	0	0	0	1

### 7.6.4 DAC8560 Data Input Register Format

**Table 5. DAC8560 Data Input Register Format**

DB23																							DB0
0	0	0	0	0	0	PD	PD	D15	D14	D13	D12	D11	D10	D9	D8	D7	D6	D5	D4	D3	D2	D1	D0
						1	0																



**Figure 69. SYNC Interrupt Facility**

## 8 Application and Implementation

### NOTE

Information in the following applications sections is not part of the TI component specification, and TI does not warrant its accuracy or completeness. TI's customers are responsible for determining suitability of components for their purposes. Customers should validate and test their design implementation to confirm system functionality.

### 8.1 Application Information

The low-power consumption of the DAC8560, coupled with the ultra-low current power-down modes, makes the device a great choice for battery-operated and portable applications such as oscilloscopes and similar test and measurement equipment. In addition to the low-power requirement, these applications often require a bipolar output range for offset and gain calibration as described in the following sections.

### 8.2 Typical Applications

The output voltage with [Figure 70](#) and [Figure 71](#) for any input code can be calculated using [Equation 4](#):

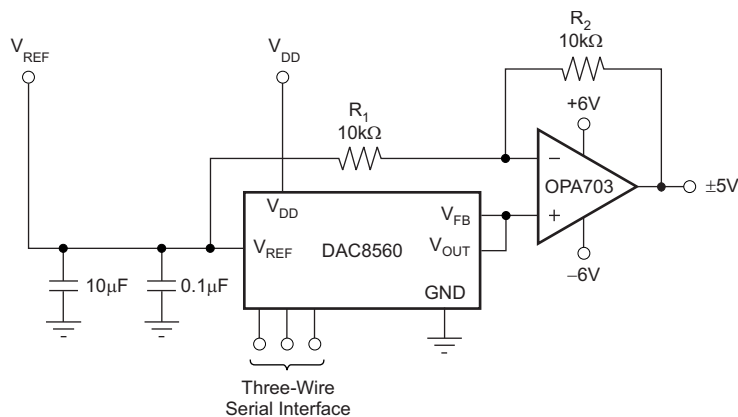
$$V_O = \left[ V_{REF} \times \left( \frac{D}{65536} \right) \times \left( \frac{R_1 + R_2}{R_1} \right) - V_{REF} \times \left( \frac{R_2}{R_1} \right) \right] \quad (4)$$

where D represents the input code in decimal (0–65535).

With  $V_{REF} = 5\text{ V}$ ,  $R_1 = R_2 = 10\text{ k}\Omega$ .

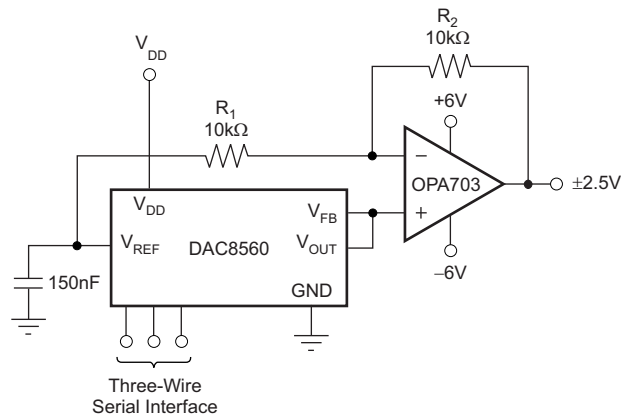
$$V_O = \left( \frac{10 \times D}{65536} \right) - 5\text{V} \quad (5)$$

This result has an output voltage range of  $\pm 5\text{ V}$  with 0000h corresponding to a  $-5\text{-V}$  output and FFFFh corresponding to a  $5\text{-V}$  output, as shown in [Figure 70](#). Similarly, using the internal reference, a  $\pm 2.5\text{-V}$  output voltage range can be achieved, as shown in [Figure 71](#).

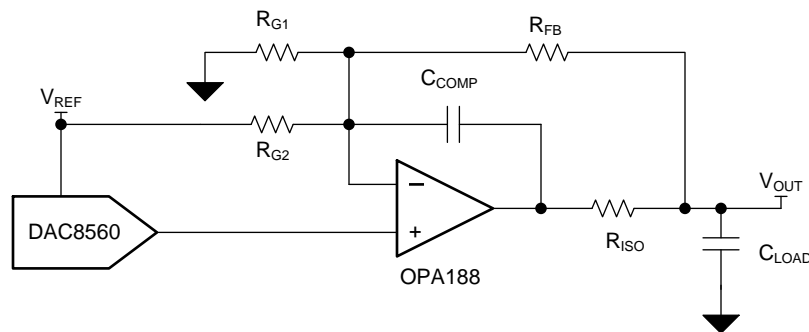


Copyright © 2018, Texas Instruments Incorporated

**Figure 70. Bipolar Output Range Using External Reference at 5 V**

**Typical Applications (continued)**


Copyright © 2018, Texas Instruments Incorporated

**Figure 71. Bipolar Output Range Using Internal Reference**


Copyright © 2018, Texas Instruments Incorporated

**Figure 72. Bipolar Output Range  $> \pm V_{REF}$** 
**8.2.1 Design Requirements**

The design requirements and performance goals are summarized as follows:

- DAC Supply Voltage: +5-V DC
- Amplifier Supply Voltage:  $\pm 15$ -V DC
- Input: 3-wire, 24-bit SPI
- Output:  $\pm 10$ -V DC
- Capacitance Load: 20 nF

**Table 6. Comparison of Design Goal, Simulation, and Measured Performance**

	GOAL	SIMULATED	MEASURED
Total unadjusted error (%FSR)	0.25	0.23	0.0939

## 8.2.2 Detailed Design Procedure or Bipolar Operation > $\pm V_{REF}$

### 8.2.2.1 Bipolar Operation Greater Than $\pm V_{REF}$

The DAC8560 has been designed for single-supply operation; a bipolar output range is also possible using the circuit in [Figure 71](#). This unipolar-to-bipolar signal conditioning circuit uses an operational amplifier (op amp) with negative feedback and three resistors in a modified summing amplifier configuration to generate high-voltage bipolar outputs. The DC transfer function is based on the ratio of the feedback resistor  $R_{FB}$  and gain setting resistors  $R_{G1}$  and  $R_{G2}$ . This design takes consideration for generating voltage outputs and for driving reactive loads such as long cables common in industrial process control applications. The circuit shown in [Figure 72](#) gives an output voltage range greater than  $\pm V_{REF}$ .

The DC transfer function for this design is defined as:

$$V_{OUT} = \left(1 + \frac{R_{FB}}{R_{G2}} + \frac{R_{FB}}{R_{G1}}\right) V_{DAC} - \frac{R_{FB}}{R_{G2}} V_{REF} \quad (6)$$

#### 8.2.2.1.1 Passive Component Selection

The amplifier in this circuit uses negative feedback to ensure that the voltages at the inverting and non-inverting terminals are equal. When the DAC output is at zero scale (0 V) the inverting terminal is a virtual ground so no current flows across  $R_{G1}$ ; this causes the circuit to function as an inverting amplifier with gain equal to  $R_{FB} / R_{G2}$ . When the DAC output is full-scale ( $V_{REF}$ ) the inverting terminal potential is equal to  $V_{REF}$  so no current flows across  $R_{G2}$ ; this causes the circuit to function as a non-inverting amplifier with gain equal to  $(1 + R_{FB} / R_{G1})$ . A simple three-step process can be used to select the resistor values used to realize any bipolar output range using DAC8560. The internal  $V_{REF}$  value is 2.5 V. The desired output range for this design is  $\pm 10$  V. First, using the transfer function shown in [Equation 6](#), consider the negative full-scale output case when  $V_{DAC}$  is equal to 0 V,  $V_{REF}$  is equal to 2.5 V, and  $V_{OUT}$  is equal to  $-10$  V. This case is used to calculate the ratio of  $R_{FB}$  to  $R_{G2}$  and is shown explicitly in [Equation 7](#).

$$\begin{aligned} -10 \text{ V} &= \left(1 + \frac{R_{FB}}{R_{G2}} + \frac{R_{FB}}{R_{G1}}\right) (0) - \frac{R_{FB}}{R_{G2}} (2.5 \text{ V}) \\ -10 \text{ V} &= -\frac{R_{FB}}{R_{G2}} (2.5 \text{ V}) \\ R_{FB} &= 4 \times R_{G2} \end{aligned} \quad (7)$$

Second, consider the positive full-scale output case when  $V_{DAC}$  is equal to 2.5 V,  $V_{REF}$  is equal to 2.5 V, and  $V_{OUT}$  is equal to 10 V. This case is used to calculate the ratio of  $R_{FB}$  to  $R_{G1}$  and is shown explicitly in [Equation 8](#).

$$\begin{aligned} 10 \text{ V} &= \left(1 + \frac{R_{FB}}{R_{G2}} + \frac{R_{FB}}{R_{G1}}\right) (2.5) - \frac{R_{FB}}{R_{G2}} (2.5 \text{ V}) \\ 10 \text{ V} &= \left(1 + \frac{R_{FB}}{R_{G1}}\right) (2.5 \text{ V}) \\ R_{G1} &= \frac{R_{FB}}{3} \end{aligned} \quad (8)$$

Finally, seed the ideal value of  $R_{G2}$  to calculate the ideal values of  $R_{FB}$  and  $R_{G1}$ . The key considerations for seeding the value of  $R_{G2}$  should be the drive strength of the reference source as well as choosing small resistor values to minimize noise contributed by the resistor network. For this design  $R_{G2}$  of 8.25 k $\Omega$  was chosen, which limits the peak current drawn from the reference source to approximately 333  $\mu$ A under nominal conditions, well within the 20-mA limit of the DAC8560. In this case the nearest, 0.1% tolerance, 0603 package values for each resistor are ideal.

Standard values for 0.1% resistors can be an obstacle for this design and it may take multiple iterations of seeding the values to find real components or they may not exist. Workarounds can include utilizing multiple resistors in series and/or parallel, using potentiometers for analog trim calibration, or providing extra gain in the output circuit and applying digital calibration. In systems where the output voltage must reach the design-goal end-points ( $\pm 10$  V) it may be desirable to apply additional gain to the circuit. This approach may contribute additional overall system error since the end-point errors vary from system to system. For this design, use the exact values calculated in the design process to keep error analysis easy to follow.

To deliver a near-universal cable drive solution, choose  $C_{LOAD}$  to be relatively large compared to typical cable capacitance such that its capacitance dominates the reactive load seen by the output amplifier. To drive larger capacitive loads  $R_{ISO}$ ,  $C_{COMP}$ , and  $C_{LOAD}$  may need to be adjusted. An  $R_{ISO}$  of 70  $\Omega$  and  $C_{COMP}$  of 150 pF are used for this design.

Resistor matching for the op amp resistor network is critical for the success of this design; choose components with tight tolerances. For this design 0.1% resistor values are implemented but this constraint may be adjusted based on application specific design goals. Resistor matching contributes to both offset error and gain error in this design. The tolerance of stability components  $R_{ISO}$  and  $C_{COMP}$  is not critical and 1% components are acceptable.

**Table 7. Values of Resistor Network**

RESISTOR	VALUE
$R_{G1}$	11 k $\Omega$
$R_{G2}$	8.25 k $\Omega$
$R_{FB}$	33 k $\Omega$

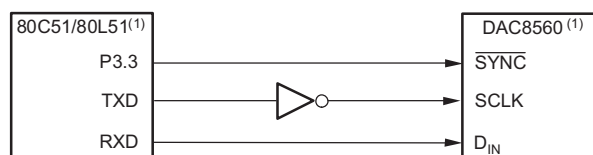
### 8.2.2.1.2 Amplifier Selection

Amplifier input offset voltage ( $V_{OS}$ ) is a key consideration for this design.  $V_{OS}$  of an op amp is a typical data-sheet specification but in-circuit performance is also impacted by drift over temperature, the common-mode rejection ratio (CMRR), and power supply rejection ratio (PSRR). Thus, consider these parameters as well. For AC operation also consider slew rate and settling time. Input-bias current (IB) can also be a factor, but typically the resistor network is implemented with sufficiently small resistor values that the effects of input-bias current are negligible.

## 8.2.2.2 Microprocessor Interfacing

### 8.2.2.2.1 DAC8560 to 8051 Interface

See [Figure 73](#) for a serial interface between the DAC8560 and a typical 8051-type microcontroller. The setup for the interface is as follows: TXD of the 8051 drives SCLK of the DAC8560, while RXD drives the serial data line of the device. The  $\overline{SYNC}$  signal is derived from a bit-programmable pin on the port of the 8051. In this case, port line P3.3 is used. When data is to be transmitted to the DAC8560, P3.3 is taken LOW. The 8051 transmits data in 8-bit bytes; thus, only eight falling clock edges occur in the transmit cycle. To load data to the DAC, P3.3 is left LOW after the first eight bits are transmitted, then a second write cycle is initiated to transmit the second byte of data. P3.3 is taken HIGH following the completion of the third write cycle. The 8051 outputs the serial data in a format which has the LSB first. The DAC8560 requires its data with the MSB as the first bit received. The 8051 transmit routine must therefore take this into account, and *mirror* the data as needed.

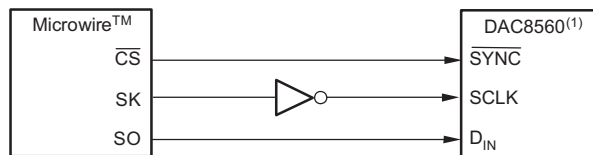


NOTE: (1) Additional pins omitted for clarity.

**Figure 73. DAC8560 to 80C51/80L51 Interface**

### 8.2.2.2.2 DAC8560 to Microwire Interface

[Figure 74](#) shows an interface between the DAC8560 and any Microwire compatible device. Serial data is shifted out on the falling edge of the serial clock and is clocked into the DAC8560 on the rising edge of the SK signal.

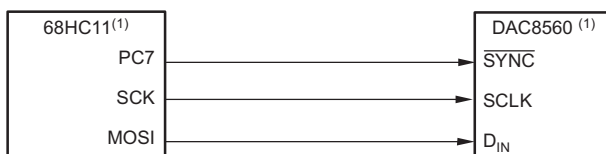


NOTE: (1) Additional pins omitted for clarity.

Figure 74. DAC8560 to Microwire Interface

### 8.2.2.2.3 DAC8560 to 68HC11 Interface

Figure 75 shows a serial interface between the DAC8560 and the 68HC11 microcontroller. SCK of the 68HC11 drives the SCLK of the DAC8560, while the MOSI output drives the serial data line of the DAC. The SYNC signal is derived from a port line (PC7), similar to the 8051 diagram.



NOTE: (1) Additional pins omitted for clarity.

Figure 75. DAC8560 to 68HC11 Interface

Configure the 68HC11 so that its CPOL bit is 0, and its CPHA bit is 1. This configuration causes data appearing on the MOSI output to be valid on the falling edge of SCK. When data is being transmitted to the DAC, the SYNC line is held LOW (PC7). Serial data from the 68HC11 is transmitted in 8-bit bytes with only eight falling clock edges occurring in the transmit cycle. (Data is transmitted MSB first.) In order to load data to the DAC8560, PC7 is left LOW after the first eight bits are transferred, then a second and third serial write operation is performed to the DAC. PC7 is taken HIGH at the end of this procedure.

### 8.2.3 Application Curves

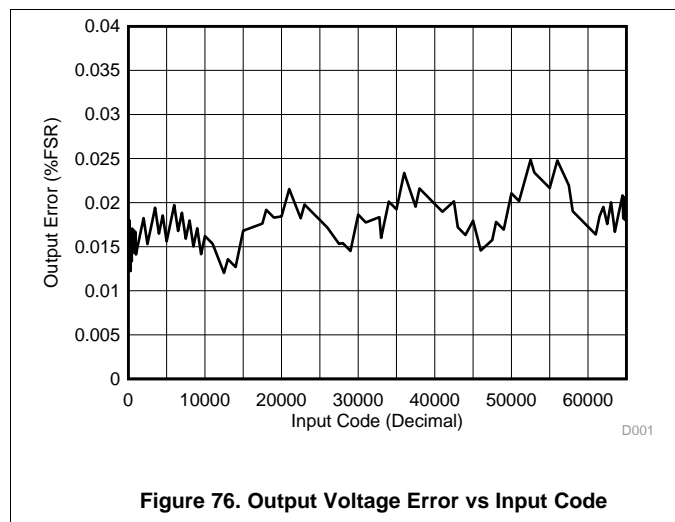


Figure 76. Output Voltage Error vs Input Code

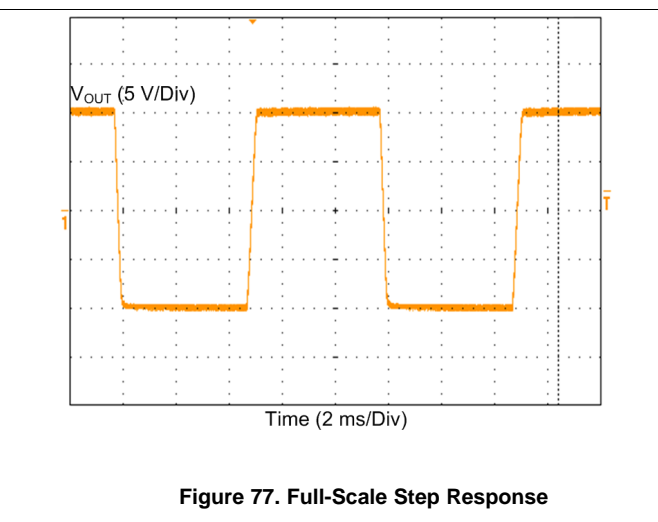


Figure 77. Full-Scale Step Response

## 9 Power Supply Recommendations

The DAC8560 can operate within the specified supply voltage range of 2.7 V to 5.5 V. The power applied to VDD must be well-regulated and low-noise. Switching power supplies and DC-DC converters often have high-frequency glitches or spikes riding on the output voltage. In addition, digital components can create similar high-frequency spikes. This noise can easily couple into the DAC output voltage through various paths between the power connections and analog output. In order to further minimize noise from the power supply, TI strongly recommends a 1- $\mu$ F to 10- $\mu$ F capacitor and 0.1- $\mu$ F bypass capacitor. The current consumption on the VDD pin, the short-circuit current limit, and the load current for the device is listed in [Electrical Characteristics](#). The power supply must meet the aforementioned current requirements.

## 10 Layout

### 10.1 Layout Guidelines

A precision analog component requires careful layout, adequate bypassing, and clean, well-regulated power supplies.

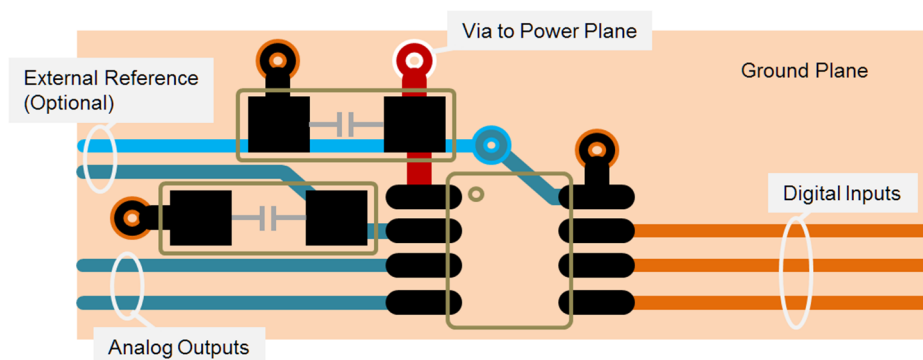
The DAC8560 offers single-supply operation, and it often is used in close proximity with digital logic, microcontrollers, microprocessors, and digital signal processors. The more digital logic present in the design and the higher the switching speed, the more difficult it is to keep digital noise from appearing at the output.

As a result of the single ground pin of the DAC8560, all return currents, including digital and analog return currents for the DAC, must flow through a single point. Ideally, connect GND directly to an analog ground plane. This plane would be separate from the ground connection for the digital components until they were connected at the power-entry point of the system.

The power applied to V<sub>DD</sub> must be well regulated and low noise. Switching power supplies and DC-DC converters often have high-frequency glitches or spikes riding on the output voltage. In addition, digital components can create similar high-frequency spikes as their internal logic switches states. This noise can easily couple into the DAC output voltage through various paths between the power connections and analog output.

As with the GND connection, connect V<sub>DD</sub> to a power-supply plane or trace that is separate from the connection for digital logic until they are connected at the power-entry point. In addition, a 1- $\mu$ F to 10- $\mu$ F capacitor and 0.1- $\mu$ F bypass capacitor are strongly recommended. In some situations, additional bypassing may be required, such as a 100- $\mu$ F electrolytic capacitor or even a *Pi* filter made up of inductors and capacitors – all designed to essentially low-pass filter the supply, removing the high-frequency noise.

### 10.2 Layout Example



**Figure 78. DAC8560 Layout Example**



## 11 Device and Documentation Support

### 11.1 Documentation Support

#### 11.1.1 Related Documentation

[CMOS, Rail-to-Rail, I/O OPERATIONAL AMPLIFIERS](#)

### 11.2 Receiving Notification of Documentation Updates

To receive notification of documentation updates, navigate to the device product folder on ti.com. In the upper right corner, click on *Alert me* to register and receive a weekly digest of any product information that has changed. For change details, review the revision history included in any revised document.

### 11.3 Community Resource

The following links connect to TI community resources. Linked contents are provided "AS IS" by the respective contributors. They do not constitute TI specifications and do not necessarily reflect TI's views; see TI's [Terms of Use](#).

**TI E2E™ Online Community** *TI's Engineer-to-Engineer (E2E) Community*. Created to foster collaboration among engineers. At e2e.ti.com, you can ask questions, share knowledge, explore ideas and help solve problems with fellow engineers.

**Design Support** *TI's Design Support* Quickly find helpful E2E forums along with design support tools and contact information for technical support.

### 11.4 Trademarks

E2E is a trademark of Texas Instruments.  
All other trademarks are the property of their respective owners.

### 11.5 Electrostatic Discharge Caution



These devices have limited built-in ESD protection. The leads should be shorted together or the device placed in conductive foam during storage or handling to prevent electrostatic damage to the MOS gates.

### 11.6 Glossary

[SLYZ022](#) — *TI Glossary*.

This glossary lists and explains terms, acronyms, and definitions.

## 12 Mechanical, Packaging, and Orderable Information

The following pages include mechanical, packaging, and orderable information. This information is the most current data available for the designated devices. This data is subject to change without notice and revision of this document. For browser-based versions of this data sheet, refer to the left-hand navigation.

**PACKAGING INFORMATION**

Orderable Device	Status (1)	Package Type	Package Drawing	Pins	Package Qty	Eco Plan (2)	Lead/Ball Finish (6)	MSL Peak Temp (3)	Op Temp (°C)	Device Marking (4/5)	Samples
DAC8560IADGKR	ACTIVE	VSSOP	DGK	8	2500	Green (RoHS & no Sb/Br)	CU NIPDAU   CU NIPDAUAG	Level-2-260C-1 YEAR	-40 to 105	D860	<a href="#">Samples</a>
DAC8560IADGKRG4	ACTIVE	VSSOP	DGK	8	2500	Green (RoHS & no Sb/Br)	CU NIPDAUAG	Level-2-260C-1 YEAR	-40 to 105	D860	<a href="#">Samples</a>
DAC8560IADGKT	ACTIVE	VSSOP	DGK	8	250	Green (RoHS & no Sb/Br)	CU NIPDAU   CU NIPDAUAG	Level-2-260C-1 YEAR	-40 to 105	D860	<a href="#">Samples</a>
DAC8560IADGKTG4	ACTIVE	VSSOP	DGK	8	250	Green (RoHS & no Sb/Br)	CU NIPDAUAG	Level-2-260C-1 YEAR	-40 to 105	D860	<a href="#">Samples</a>
DAC8560IBDGKR	ACTIVE	VSSOP	DGK	8	2500	Green (RoHS & no Sb/Br)	CU NIPDAU   CU NIPDAUAG	Level-2-260C-1 YEAR	-40 to 105	D860	<a href="#">Samples</a>
DAC8560IBDGKT	ACTIVE	VSSOP	DGK	8	250	Green (RoHS & no Sb/Br)	CU NIPDAU   CU NIPDAUAG	Level-2-260C-1 YEAR	-40 to 105	D860	<a href="#">Samples</a>
DAC8560IBDGKTG4	ACTIVE	VSSOP	DGK	8	250	Green (RoHS & no Sb/Br)	CU NIPDAUAG	Level-2-260C-1 YEAR	-40 to 105	D860	<a href="#">Samples</a>
DAC8560ICDGKR	ACTIVE	VSSOP	DGK	8	2500	Green (RoHS & no Sb/Br)	CU NIPDAU   CU NIPDAUAG	Level-2-260C-1 YEAR	-40 to 105	D860	<a href="#">Samples</a>
DAC8560ICDGKT	ACTIVE	VSSOP	DGK	8	250	Green (RoHS & no Sb/Br)	CU NIPDAU   CU NIPDAUAG	Level-2-260C-1 YEAR	-40 to 105	D860	<a href="#">Samples</a>
DAC8560ICDGKTG4	ACTIVE	VSSOP	DGK	8	250	Green (RoHS & no Sb/Br)	CU NIPDAUAG	Level-2-260C-1 YEAR	-40 to 105	D860	<a href="#">Samples</a>
DAC8560IDDGKR	ACTIVE	VSSOP	DGK	8	2500	Green (RoHS & no Sb/Br)	CU NIPDAU   CU NIPDAUAG	Level-2-260C-1 YEAR	-40 to 105	D860	<a href="#">Samples</a>
DAC8560IDDGKT	ACTIVE	VSSOP	DGK	8	250	Green (RoHS & no Sb/Br)	CU NIPDAU   CU NIPDAUAG	Level-2-260C-1 YEAR	-40 to 105	D860	<a href="#">Samples</a>
DAC8560IDDGKTG4	ACTIVE	VSSOP	DGK	8	250	Green (RoHS & no Sb/Br)	CU NIPDAUAG	Level-2-260C-1 YEAR	-40 to 105	D860	<a href="#">Samples</a>

(1) The marketing status values are defined as follows:

**ACTIVE:** Product device recommended for new designs.

**LIFEBUY:** TI has announced that the device will be discontinued, and a lifetime-buy period is in effect.

**NRND:** Not recommended for new designs. Device is in production to support existing customers, but TI does not recommend using this part in a new design.

**PREVIEW:** Device has been announced but is not in production. Samples may or may not be available.

**OBSOLETE:** TI has discontinued the production of the device.

(2) **RoHS:** TI defines "RoHS" to mean semiconductor products that are compliant with the current EU RoHS requirements for all 10 RoHS substances, including the requirement that RoHS substance do not exceed 0.1% by weight in homogeneous materials. Where designed to be soldered at high temperatures, "RoHS" products are suitable for use in specified lead-free processes. TI may reference these types of products as "Pb-Free".

**RoHS Exempt:** TI defines "RoHS Exempt" to mean products that contain lead but are compliant with EU RoHS pursuant to a specific EU RoHS exemption.

**Green:** TI defines "Green" to mean the content of Chlorine (Cl) and Bromine (Br) based flame retardants meet JS709B low halogen requirements of  $\leq 1000$ ppm threshold. Antimony trioxide based flame retardants must also meet the  $\leq 1000$ ppm threshold requirement.

(3) MSL, Peak Temp. - The Moisture Sensitivity Level rating according to the JEDEC industry standard classifications, and peak solder temperature.

(4) There may be additional marking, which relates to the logo, the lot trace code information, or the environmental category on the device.

(5) Multiple Device Markings will be inside parentheses. Only one Device Marking contained in parentheses and separated by a "~" will appear on a device. If a line is indented then it is a continuation of the previous line and the two combined represent the entire Device Marking for that device.

(6) Lead/Ball Finish - Orderable Devices may have multiple material finish options. Finish options are separated by a vertical ruled line. Lead/Ball Finish values may wrap to two lines if the finish value exceeds the maximum column width.

**Important Information and Disclaimer:** The information provided on this page represents TI's knowledge and belief as of the date that it is provided. TI bases its knowledge and belief on information provided by third parties, and makes no representation or warranty as to the accuracy of such information. Efforts are underway to better integrate information from third parties. TI has taken and continues to take reasonable steps to provide representative and accurate information but may not have conducted destructive testing or chemical analysis on incoming materials and chemicals. TI and TI suppliers consider certain information to be proprietary, and thus CAS numbers and other limited information may not be available for release.

In no event shall TI's liability arising out of such information exceed the total purchase price of the TI part(s) at issue in this document sold by TI to Customer on an annual basis.

**TAPE AND REEL INFORMATION**

**QUADRANT ASSIGNMENTS FOR PIN 1 ORIENTATION IN TAPE**


\*All dimensions are nominal

Device	Package Type	Package Drawing	Pins	SPQ	Reel Diameter (mm)	Reel Width W1 (mm)	A0 (mm)	B0 (mm)	K0 (mm)	P1 (mm)	W (mm)	Pin1 Quadrant
DAC8560IADGKR	VSSOP	DGK	8	2500	330.0	12.4	5.3	3.4	1.4	8.0	12.0	Q1
DAC8560IADGKT	VSSOP	DGK	8	250	180.0	12.4	5.3	3.4	1.4	8.0	12.0	Q1
DAC8560IBDGKR	VSSOP	DGK	8	2500	330.0	12.4	5.3	3.4	1.4	8.0	12.0	Q1
DAC8560IBDGKT	VSSOP	DGK	8	250	180.0	12.4	5.3	3.4	1.4	8.0	12.0	Q1
DAC8560ICDGKR	VSSOP	DGK	8	2500	330.0	12.4	5.3	3.4	1.4	8.0	12.0	Q1
DAC8560ICDGKT	VSSOP	DGK	8	250	180.0	12.4	5.3	3.4	1.4	8.0	12.0	Q1
DAC8560IDDGKR	VSSOP	DGK	8	2500	330.0	12.4	5.3	3.4	1.4	8.0	12.0	Q1
DAC8560IDDGKT	VSSOP	DGK	8	250	180.0	12.4	5.3	3.4	1.4	8.0	12.0	Q1

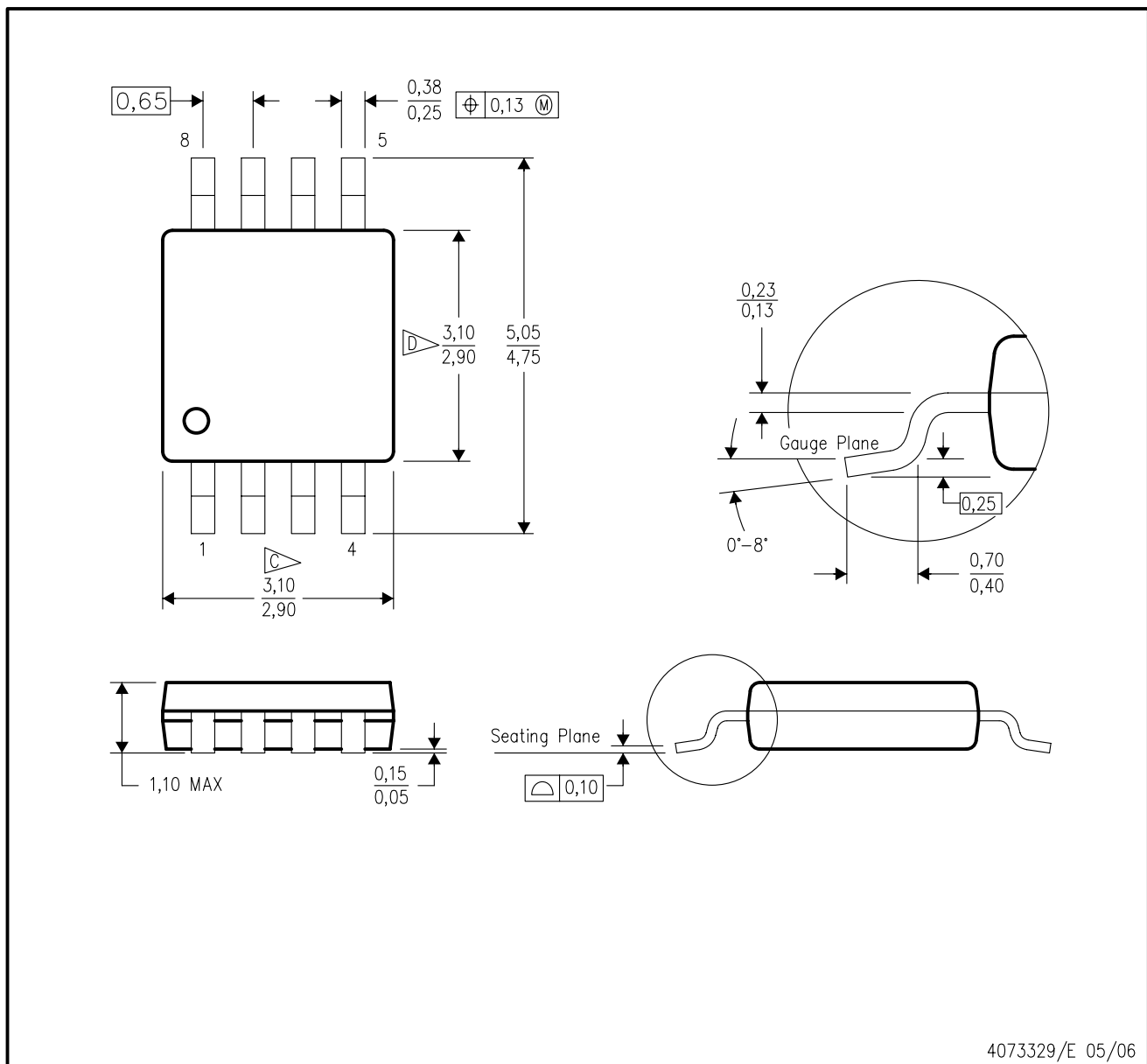
**TAPE AND REEL BOX DIMENSIONS**


\*All dimensions are nominal

Device	Package Type	Package Drawing	Pins	SPQ	Length (mm)	Width (mm)	Height (mm)
DAC8560IADGKR	VSSOP	DGK	8	2500	367.0	367.0	38.0
DAC8560IADGKT	VSSOP	DGK	8	250	210.0	185.0	35.0
DAC8560IBDGKR	VSSOP	DGK	8	2500	367.0	367.0	38.0
DAC8560IBDGKT	VSSOP	DGK	8	250	210.0	185.0	35.0
DAC8560ICDGKR	VSSOP	DGK	8	2500	367.0	367.0	38.0
DAC8560ICDGKT	VSSOP	DGK	8	250	210.0	185.0	35.0
DAC8560IDDGKR	VSSOP	DGK	8	2500	367.0	367.0	38.0
DAC8560IDDGKT	VSSOP	DGK	8	250	210.0	185.0	35.0

DGK (S-PDSO-G8)

PLASTIC SMALL-OUTLINE PACKAGE



- NOTES:
- A. All linear dimensions are in millimeters.
  - B. This drawing is subject to change without notice.
  - C. Body length does not include mold flash, protrusions, or gate burrs. Mold flash, protrusions, or gate burrs shall not exceed 0.15 per end.
  - D. Body width does not include interlead flash. Interlead flash shall not exceed 0.50 per side.
  - E. Falls within JEDEC MO-187 variation AA, except interlead flash.



- NOTES:
- A. All linear dimensions are in millimeters.
  - B. This drawing is subject to change without notice.
  - C. Publication IPC-7351 is recommended for alternate designs.
  - D. Laser cutting apertures with trapezoidal walls and also rounding corners will offer better paste release. Customers should contact their board assembly site for stencil design recommendations. Refer to IPC-7525 for other stencil recommendations.
  - E. Customers should contact their board fabrication site for solder mask tolerances between and around signal pads.

## IMPORTANT NOTICE

Texas Instruments Incorporated (TI) reserves the right to make corrections, enhancements, improvements and other changes to its semiconductor products and services per JESD46, latest issue, and to discontinue any product or service per JESD48, latest issue. Buyers should obtain the latest relevant information before placing orders and should verify that such information is current and complete.

TI's published terms of sale for semiconductor products (<http://www.ti.com/sc/docs/stdterms.htm>) apply to the sale of packaged integrated circuit products that TI has qualified and released to market. Additional terms may apply to the use or sale of other types of TI products and services.

Reproduction of significant portions of TI information in TI data sheets is permissible only if reproduction is without alteration and is accompanied by all associated warranties, conditions, limitations, and notices. TI is not responsible or liable for such reproduced documentation. Information of third parties may be subject to additional restrictions. Resale of TI products or services with statements different from or beyond the parameters stated by TI for that product or service voids all express and any implied warranties for the associated TI product or service and is an unfair and deceptive business practice. TI is not responsible or liable for any such statements.

Buyers and others who are developing systems that incorporate TI products (collectively, "Designers") understand and agree that Designers remain responsible for using their independent analysis, evaluation and judgment in designing their applications and that Designers have full and exclusive responsibility to assure the safety of Designers' applications and compliance of their applications (and of all TI products used in or for Designers' applications) with all applicable regulations, laws and other applicable requirements. Designer represents that, with respect to their applications, Designer has all the necessary expertise to create and implement safeguards that (1) anticipate dangerous consequences of failures, (2) monitor failures and their consequences, and (3) lessen the likelihood of failures that might cause harm and take appropriate actions. Designer agrees that prior to using or distributing any applications that include TI products, Designer will thoroughly test such applications and the functionality of such TI products as used in such applications.

TI's provision of technical, application or other design advice, quality characterization, reliability data or other services or information, including, but not limited to, reference designs and materials relating to evaluation modules, (collectively, "TI Resources") are intended to assist designers who are developing applications that incorporate TI products; by downloading, accessing or using TI Resources in any way, Designer (individually or, if Designer is acting on behalf of a company, Designer's company) agrees to use any particular TI Resource solely for this purpose and subject to the terms of this Notice.

TI's provision of TI Resources does not expand or otherwise alter TI's applicable published warranties or warranty disclaimers for TI products, and no additional obligations or liabilities arise from TI providing such TI Resources. TI reserves the right to make corrections, enhancements, improvements and other changes to its TI Resources. TI has not conducted any testing other than that specifically described in the published documentation for a particular TI Resource.

Designer is authorized to use, copy and modify any individual TI Resource only in connection with the development of applications that include the TI product(s) identified in such TI Resource. NO OTHER LICENSE, EXPRESS OR IMPLIED, BY ESTOPPEL OR OTHERWISE TO ANY OTHER TI INTELLECTUAL PROPERTY RIGHT, AND NO LICENSE TO ANY TECHNOLOGY OR INTELLECTUAL PROPERTY RIGHT OF TI OR ANY THIRD PARTY IS GRANTED HEREIN, including but not limited to any patent right, copyright, mask work right, or other intellectual property right relating to any combination, machine, or process in which TI products or services are used. Information regarding or referencing third-party products or services does not constitute a license to use such products or services, or a warranty or endorsement thereof. Use of TI Resources may require a license from a third party under the patents or other intellectual property of the third party, or a license from TI under the patents or other intellectual property of TI.

TI RESOURCES ARE PROVIDED "AS IS" AND WITH ALL FAULTS. TI DISCLAIMS ALL OTHER WARRANTIES OR REPRESENTATIONS, EXPRESS OR IMPLIED, REGARDING RESOURCES OR USE THEREOF, INCLUDING BUT NOT LIMITED TO ACCURACY OR COMPLETENESS, TITLE, ANY EPIDEMIC FAILURE WARRANTY AND ANY IMPLIED WARRANTIES OF MERCHANTABILITY, FITNESS FOR A PARTICULAR PURPOSE, AND NON-INFRINGEMENT OF ANY THIRD PARTY INTELLECTUAL PROPERTY RIGHTS. TI SHALL NOT BE LIABLE FOR AND SHALL NOT DEFEND OR INDEMNIFY DESIGNER AGAINST ANY CLAIM, INCLUDING BUT NOT LIMITED TO ANY INFRINGEMENT CLAIM THAT RELATES TO OR IS BASED ON ANY COMBINATION OF PRODUCTS EVEN IF DESCRIBED IN TI RESOURCES OR OTHERWISE. IN NO EVENT SHALL TI BE LIABLE FOR ANY ACTUAL, DIRECT, SPECIAL, COLLATERAL, INDIRECT, PUNITIVE, INCIDENTAL, CONSEQUENTIAL OR EXEMPLARY DAMAGES IN CONNECTION WITH OR ARISING OUT OF TI RESOURCES OR USE THEREOF, AND REGARDLESS OF WHETHER TI HAS BEEN ADVISED OF THE POSSIBILITY OF SUCH DAMAGES.

Unless TI has explicitly designated an individual product as meeting the requirements of a particular industry standard (e.g., ISO/TS 16949 and ISO 26262), TI is not responsible for any failure to meet such industry standard requirements.

Where TI specifically promotes products as facilitating functional safety or as compliant with industry functional safety standards, such products are intended to help enable customers to design and create their own applications that meet applicable functional safety standards and requirements. Using products in an application does not by itself establish any safety features in the application. Designers must ensure compliance with safety-related requirements and standards applicable to their applications. Designer may not use any TI products in life-critical medical equipment unless authorized officers of the parties have executed a special contract specifically governing such use. Life-critical medical equipment is medical equipment where failure of such equipment would cause serious bodily injury or death (e.g., life support, pacemakers, defibrillators, heart pumps, neurostimulators, and implantables). Such equipment includes, without limitation, all medical devices identified by the U.S. Food and Drug Administration as Class III devices and equivalent classifications outside the U.S.

TI may expressly designate certain products as completing a particular qualification (e.g., Q100, Military Grade, or Enhanced Product). Designers agree that it has the necessary expertise to select the product with the appropriate qualification designation for their applications and that proper product selection is at Designers' own risk. Designers are solely responsible for compliance with all legal and regulatory requirements in connection with such selection.

Designer will fully indemnify TI and its representatives against any damages, costs, losses, and/or liabilities arising out of Designer's non-compliance with the terms and provisions of this Notice.