

## ±3-A HIGH-EFFICIENCY PWM POWER DRIVER

 Check for Samples: [DRV593](#), [DRV594](#)

### FEATURES

- Operation Reduces Output Filter Size and Cost by 50% Compared to DRV591
- ±3-A Maximum Output Current
- Low Supply Voltage Operation: 2.8 V to 5.5 V
- High Efficiency Generates Less Heat
- Overcurrent and Thermal Protection
- Fault Indicators for Overcurrent, Thermal and Undervoltage Conditions
- Two Selectable Switching Frequencies
- Internal or External Clock Sync
- PWM Scheme Optimized for EMI
- 9×9 mm PowerPAD™ Quad Flatpack Package

### APPLICATIONS

- Thermoelectric Cooler (TEC) Driver
- Laser Diode Biasing

### DESCRIPTION

The DRV593 and DRV594 are high-efficiency, high-current power amplifiers ideal for driving a wide variety of thermoelectric cooler elements in systems powered from 2.8 V to 5.5 V. The operation of the device requires only one inductor and capacitor for the output filter, saving significant printed-circuit board area. Pulse-width modulation (PWM) operation and low output stage on-resistance significantly decrease power dissipation in the amplifier.

The DRV593 and DRV594 are internally protected against thermal and current overloads. Logic-level fault indicators signal when the junction temperature has reached approximately 128°C to allow for system-level shutdown before the amplifier's internal thermal shutdown circuitry activates. The fault indicators also signal when an overcurrent event has occurred. If the overcurrent circuitry is tripped, the devices automatically reset (see application information section for more details).

The PWM switching frequency may be set to 500 kHz or 100 kHz depending on system requirements. To eliminate external components, the gain is fixed at 2.3 V/V for the DRV593. For the DRV594, the gain is fixed at 14.5 V/V.

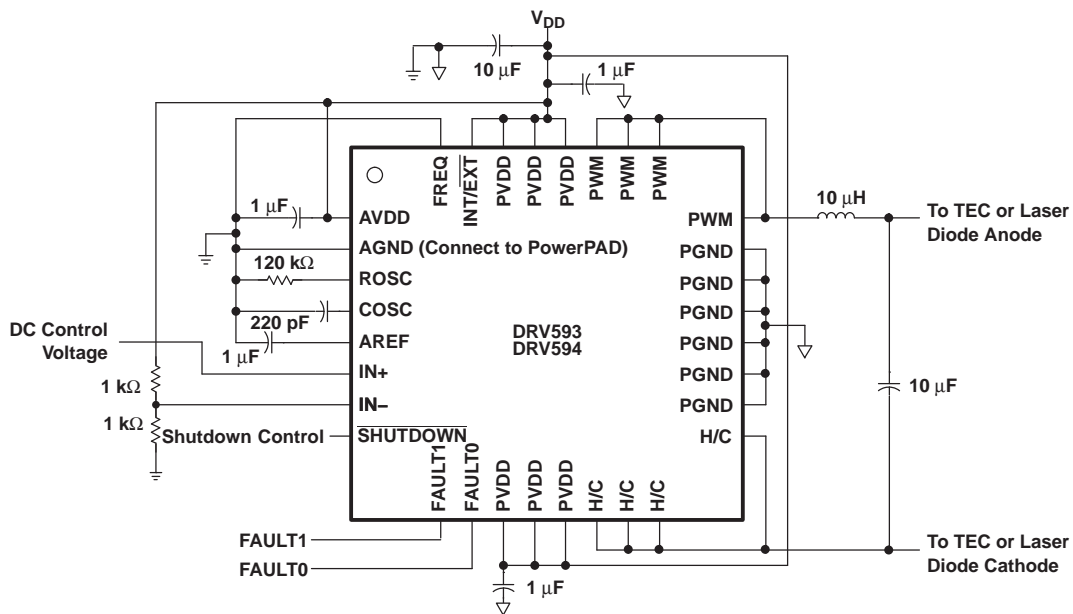

Please be aware that an important notice concerning availability, standard warranty, and use in critical applications of Texas Instruments semiconductor products and disclaimers thereto appears at the end of this data sheet.

PowerPAD is a trademark of Texas Instruments.



This integrated circuit can be damaged by ESD. Texas Instruments recommends that all integrated circuits be handled with appropriate precautions. Failure to observe proper handling and installation procedures can cause damage.

ESD damage can range from subtle performance degradation to complete device failure. Precision integrated circuits may be more susceptible to damage because very small parametric changes could cause the device not to meet its published specifications.

**Table 1. ORDERING INFORMATION<sup>(1)</sup>**

| $T_A$         | PowerPAD QUAD FLATPACK (VFP) |
|---------------|------------------------------|
| -40°C to 85°C | DRV593VFP <sup>(2)</sup>     |
|               | DRV594VFP <sup>(2)</sup>     |

- (1) For the most current package and ordering information, see the Package Option Addendum at the end of this document, or see the TI Web site at [www.ti.com](http://www.ti.com)
- (2) This package is available taped and reeled. To order this packaging option, add an R suffix to the part number (e.g., DRV593VFPR or DRV594VFPR).

## ABSOLUTE MAXIMUM RATINGS

over operating free-air temperature range unless otherwise noted<sup>(1)</sup>

|                                    |                                      | DRV593, DRV594               |
|------------------------------------|--------------------------------------|------------------------------|
| AVDD, PVDD                         | Supply voltage                       | -0.3 V to 5.5 V              |
| $V_I$                              | Input voltage                        | -0.3 V to $V_{DD} + 0.3$ V   |
| $I_O$ (FAULT0, FAULT1)             | Output current                       | 1 mA                         |
| Continuous total power dissipation |                                      | See Dissipation Rating Table |
| $T_A$                              | Operating free-air temperature range | -40°C to 85°C                |
| $T_J$                              | Operating junction temperature range | -40°C to 150°C               |
| $T_{stg}$                          | Storage temperature range            | -65°C to 165°C               |

- (1) Stresses beyond those listed under absolute maximum ratings may cause permanent damage to the device. These are stress ratings only, and functional operation of the device at these or any other conditions beyond those indicated under recommended operating conditions is not implied. Exposure to absolute-maximum-rated conditions for extended periods may affect device reliability.

## RECOMMENDED OPERATING CONDITIONS

|            |                                |                               | MIN | MAX | UNIT |
|------------|--------------------------------|-------------------------------|-----|-----|------|
| AVDD, PVDD | Supply voltage                 |                               | 2.8 | 5.5 | V    |
| $V_{IH}$   | High-level input voltage       | FREQ, INT/EXT, SHUTDOWN, COSC | 2   |     | V    |
| $V_{IL}$   | Low-level input voltage        | FREQ, INT/EXT, SHUTDOWN, COSC |     | 0.8 | V    |
| $T_A$      | Operating free-air temperature |                               | -40 | 85  | °C   |

## PACKAGE DISSIPATION RATINGS

| PACKAGE | $\theta_{JA}$ <sup>(1)</sup><br>(°C/W) | $\theta_{JC}$<br>(°C/W) | $T_A=25^\circ\text{C}$<br>POWER RATING |
|---------|--|-------------------------|--|
| VFP     | 29.4                                   | 1.2                     | 4.1 W                                  |

- (1) This data was taken using 2 oz trace and copper pad that is soldered directly to a JEDEC standard 4-layer 3 in x 3 in PCB.

## ELECTRICAL CHARACTERISTICS

over operating free-air temperature range unless otherwise noted

| PARAMETER    |  | TEST CONDITIONS  | MIN       | TYP  | MAX  | UNIT       |            |
|--------------|--|--|-----------|------|------|------------|------------|
| $ V_{OO} $   | Output offset voltage (measured differentially)                              | $V_I = V_{DD}/2$ ,<br>$I_O = 0$ A                              | 14        | 100  |      | mV         |            |
| $ I_{IH} $   | High-level input current   | $V_{DD} = 5.5$ V,<br>$V_I = V_{DD}$                            |           |      | 1    | $\mu$ A    |            |
| $ I_{IL} $   | Low-level input current  | $V_{DD} = 5.5$ V,<br>$V_I = 0$ V                               |           |      | 1    | $\mu$ A    |            |
| $V_n$        | Integrated output noise voltage  | $f = <1$ Hz to 10 kHz  |           | 40   |      | $\mu$ V    |            |
| $V_{ICM}$    | Common-mode voltage range  | $V_{DD} = 5$ V   | 1.2       |      | 3.8  | V          |            |
|              |  | $V_{DD} = 3.3$ V   | 1.2       |      | 2.1  |            |            |
| $A_v$        | Closed-loop voltage gain   | DRV593   | 2.1       | 2.3  | 2.6  | V/V        |            |
|              |  | DRV594   | 13.7      | 14.5 | 15.3 | V/V        |            |
|              | Full power bandwidth   |  |           | 60   |      | kHz        |            |
| $V_O$        | Voltage output (measured differentially)                                     | $I_O = \pm 1$ A, $r_{DS(on)} = 65$ m $\Omega$ , $V_{DD} = 5$ V |           | 4.87 |      | V          |            |
|              |  | $I_O = \pm 3$ A, $r_{DS(on)} = 65$ m $\Omega$ , $V_{DD} = 5$ V |           | 4.61 |      |            |            |
| $r_{DS(on)}$ | Drain-source on-state resistance   | $V_{DD} = 5$ V, $I_O = 4$ A,<br>$T_A = 25^\circ$ C             | High side | 25   | 60   | 95         | m $\Omega$ |
|              |  |  | Low side  | 25   | 65   | 95         |            |
|              |  | $V_{DD} = 3.3$ V, $I_O = 4$ A,<br>$T_A = 25^\circ$ C           | High side | 25   | 80   | 140        | m $\Omega$ |
|              |  |  | Low side  | 25   | 90   | 140        |            |
|              | Maximum continuous current output  |  |           | 3    |      | A          |            |
|              | Status flag output pins (FAULT0, FAULT1)<br>Fault active (open drain output) | Sinking 200 $\mu$ A  |           |      | 0.1  | V          |            |
|              | External clock frequency range   | For 500 kHz operation  | 225       | 250  | 300  | kHz        |            |
|              |  | For 100 kHz operation  | 45        | 50   | 55   |            |            |
| $I_q$        | Quiescent current  | $V_{DD} = 5$ V, No load or filter                              |           | 4    | 12   | mA         |            |
|              |  | $V_{DD} = 3.3$ V, No load or filter                            |           | 2.5  | 8    |            |            |
| $I_{q(SD)}$  | Quiescent current in shutdown mode   | $V_{DD} = 5$ V, $\overline{\text{SHUTDOWN}} = 0.8$ V           | 0         | 40   | 80   | $\mu$ A    |            |
|              | Output resistance in shutdown  | $\overline{\text{SHUTDOWN}} = 0.8$ V                           | 1         | 2    |      | k $\Omega$ |            |
|              | Power-on threshold   |  | 1.7       |      | 2.8  | V          |            |
|              | Power-off threshold  |  | 1.6       |      | 2.6  | V          |            |
|              | Thermal trip point   | FAULT0 active  |           | 128  |      | $^\circ$ C |            |
|              | Thermal shutdown   | Power off  |           | 158  |      | $^\circ$ C |            |
| $Z_I$        | Input impedance (IN+, IN-)   |  |           | 100  |      | k $\Omega$ |            |

## PIN ASSIGNMENTS

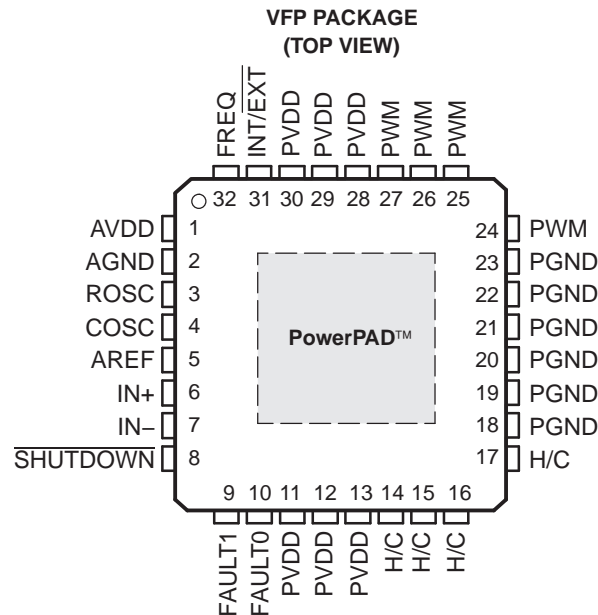

## TERMINAL FUNCTIONS

| TERMINAL NAME | TERMINAL NO.                 | I/O | DESCRIPTION  |
|---------------|------------------------------|-----|--|
| AGND          | 2                            |     | Analog ground  |
| AREF          | 5                            | O   | Connect 1 $\mu$ F capacitor to ground for AREF voltage filtering   |
| AVDD          | 1                            | I   | Analog power supply  |
| COSC          | 4                            | I   | Connect capacitor to ground to set oscillation frequency (220 pF for 500 kHz, 1 nF for 100 kHz) when the internal oscillator is selected; connect clock signal when an external oscillator is used |
| FAULT0        | 10                           | O   | Fault flag 0, low when active open drain output (see application information)  |
| FAULT1        | 9                            | O   | Fault flag 1, high when active open drain output (see application information)   |
| FREQ          | 32                           | I   | Selects 500 kHz switching frequency when a TTL logic low is applied to this terminal; selects 100 kHz switching frequency when a TTL logic high is applied   |
| IN-           | 7                            | I   | Negative differential input  |
| IN+           | 6                            | I   | Positive differential input  |
| INT/EXT       | 31                           | I   | Selects the internal oscillator when a TTL logic high is applied to this terminal; selects the use of an external oscillator when a TTL logic low is applied to this terminal                      |
| H/C           | 14, 15,<br>16, 17            | O   | Direction control output for heat and cool modes (4 pins)  |
| PWM           | 24, 25,<br>26, 27            | O   | PWM output for voltage magnitude (4 pins)  |
| PGND          | 18, 19,<br>20, 21,<br>22, 23 |     | High-current ground (6 pins)   |
| PVDD          | 11, 12,<br>13, 28,<br>29, 30 | I   | High-current power supply (6 pins)   |
| ROSC          | 3                            | I   | Connect 120-k $\Omega$ resistor to AGND to set oscillation frequency (either 500 kHz or 100 kHz). Not needed if an external clock is used.   |
| SHUTDOWN      | 8                            | I   | Places the amplifier in shutdown mode when a TTL logic low is applied to this terminal; places the amplifier in normal operation when a TTL logic high is applied                                  |

FUNCTIONAL BLOCK DIAGRAM

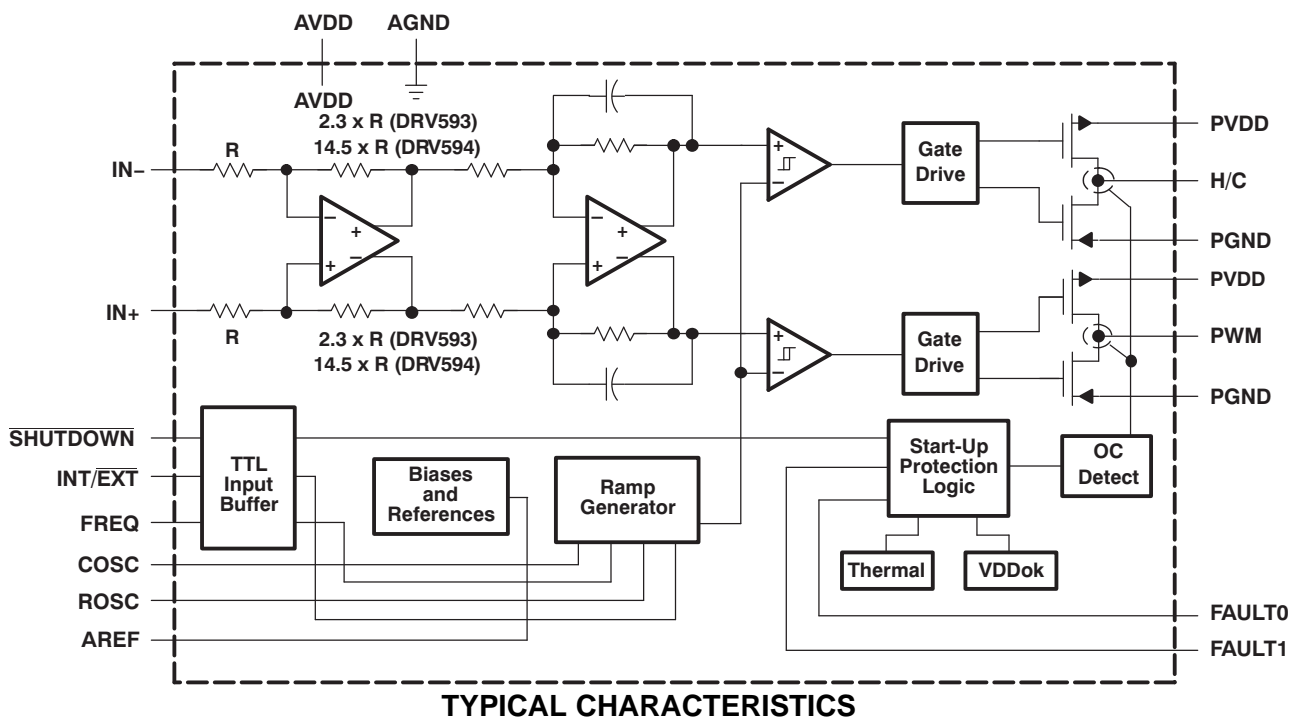
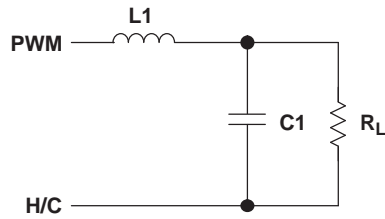

Table of Graphs

|              |                                  |                           | FIGURE |
|--------------|----------------------------------|---------------------------|--------|
| Efficiency   |                                  | vs Load resistance        | 2, 3   |
| $r_{DS(on)}$ | Drain-source on-state resistance | vs Supply voltage         | 4      |
|              |                                  | vs Free-air temperature   | 5      |
|              |                                  | vs Free-air temperature   | 6      |
|              |                                  | vs Supply voltage         | 7      |
| PSRR         | Power supply rejection ratio     | vs Frequency              | 8, 9   |
|              | Closed loop response             |                           | 12, 13 |
| $I_O$        | Maximum output current           | vs Output voltage         | 14     |
|              |                                  | vs Ambient temperature    | 15     |
| $V_{IO}$     | Input offset voltage             | Common-mode input voltage | 16, 17 |

## TEST SETUP FOR GRAPHS

The LC output filter used in [Figure 2](#), [Figure 3](#), [Figure 8](#), and [Figure 9](#) is shown below.



L1 = 10  $\mu$ H (part number: CDRH104R, manufacturer: Sumida)  
C1 = 10  $\mu$ F (part number: ECJ-4YB1C106K, manufacturer: Panasonic)

**Figure 1. LC Output Filter**

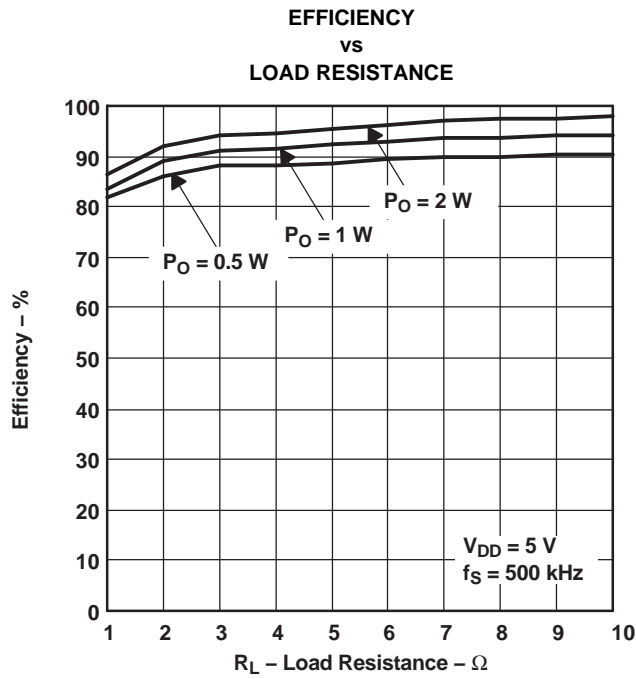

**Figure 2.**

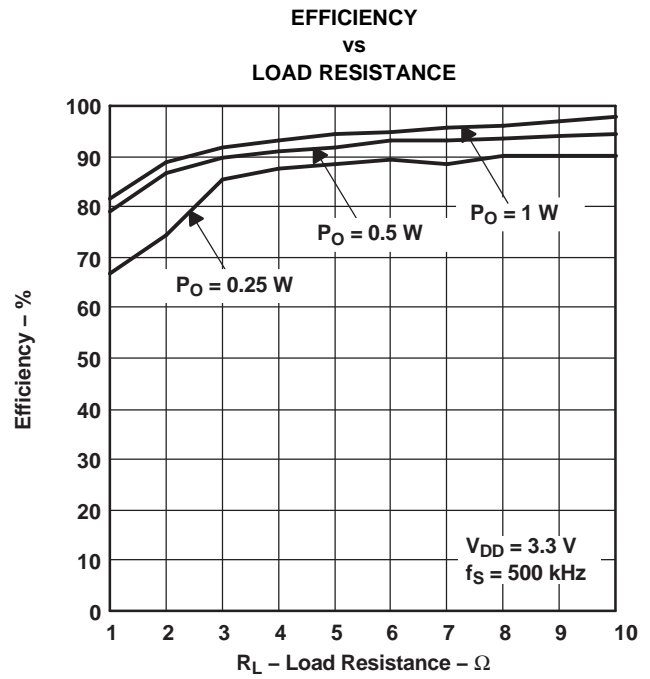

**Figure 3.**

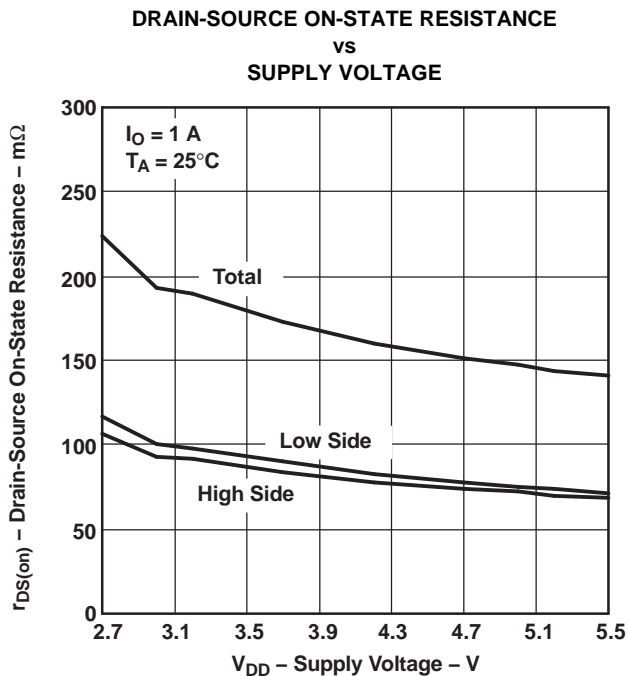

Figure 4.

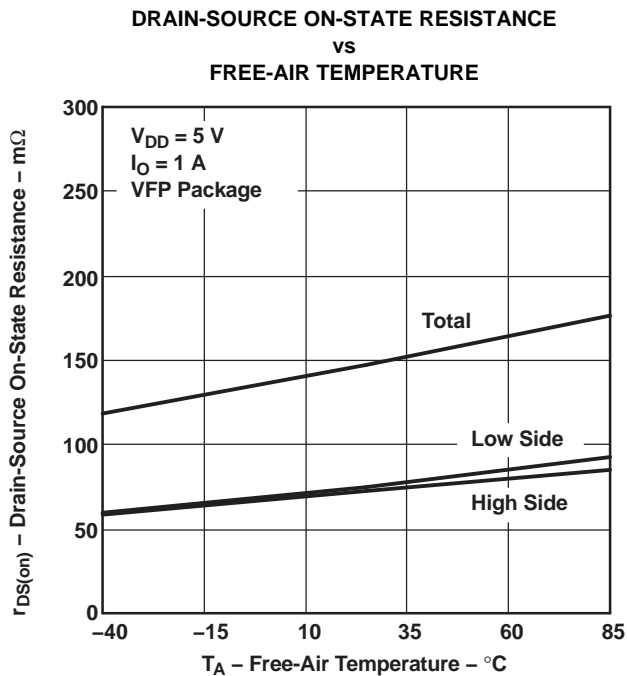

Figure 5.

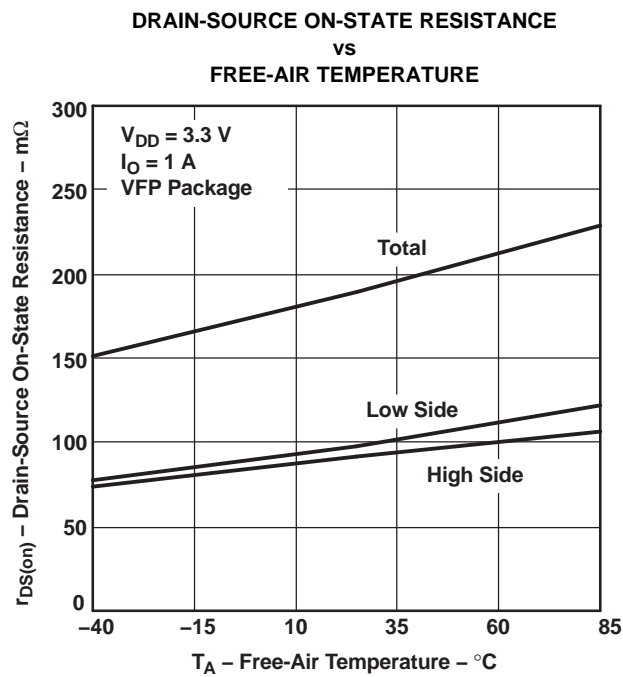

Figure 6.

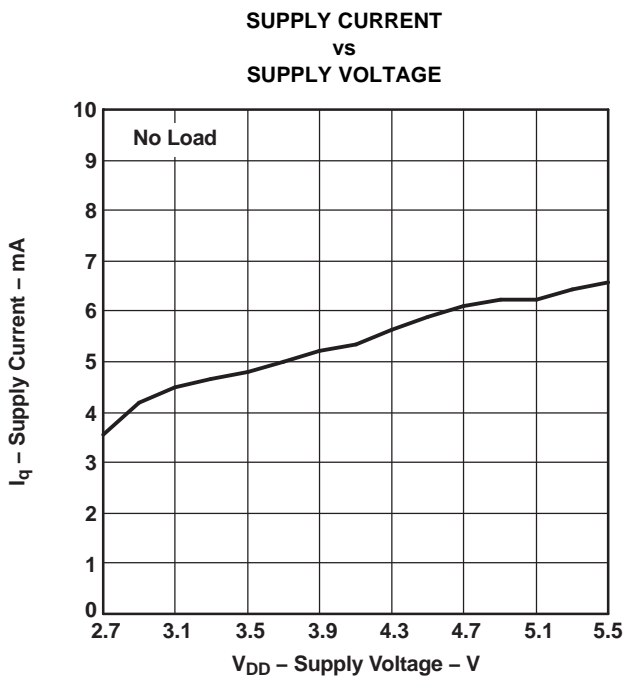

Figure 7.

POWER SUPPLY REJECTION RATIO  
vs  
FREQUENCY

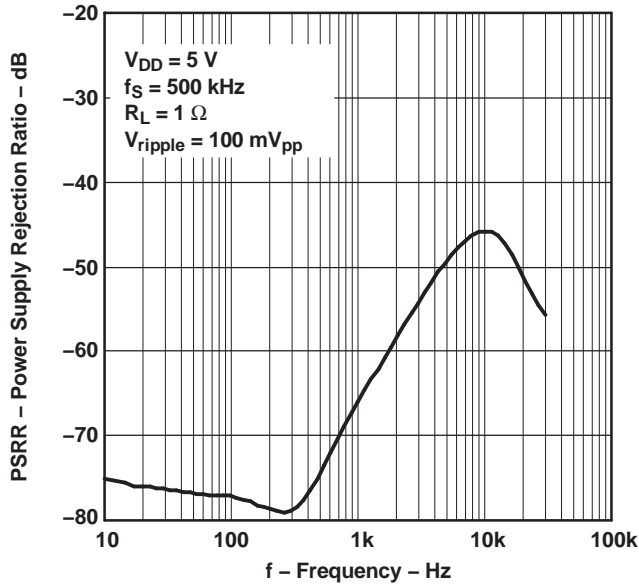

Figure 8.

POWER SUPPLY REJECTION RATIO  
vs  
FREQUENCY

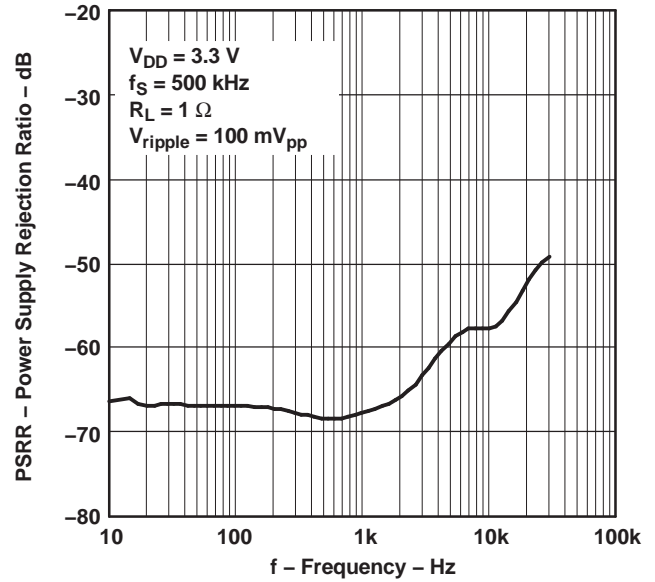

Figure 9.

DRV593  
CLOSED LOOP RESPONSE

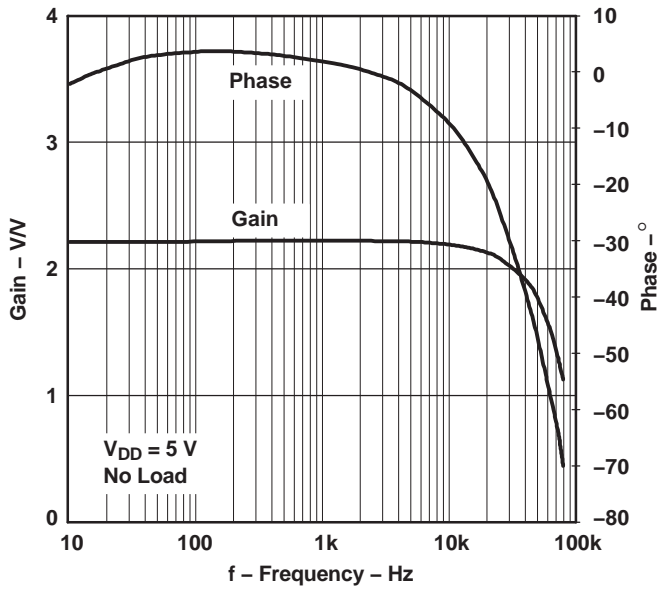

Figure 10.

DRV594  
CLOSED LOOP RESPONSE

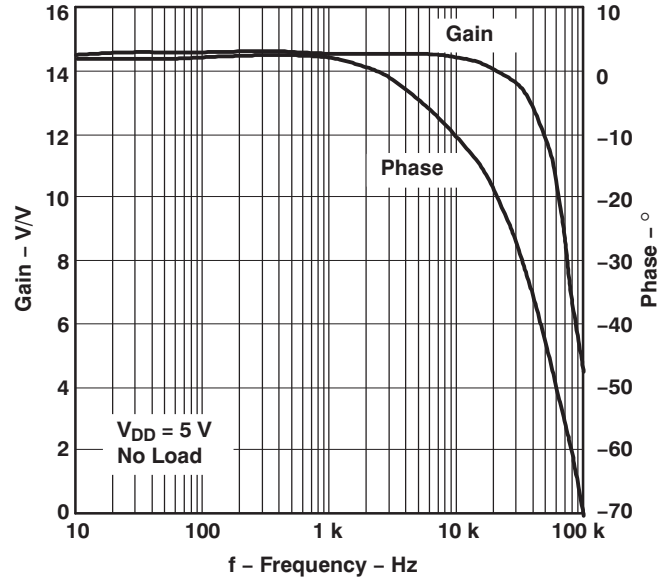

Figure 11.



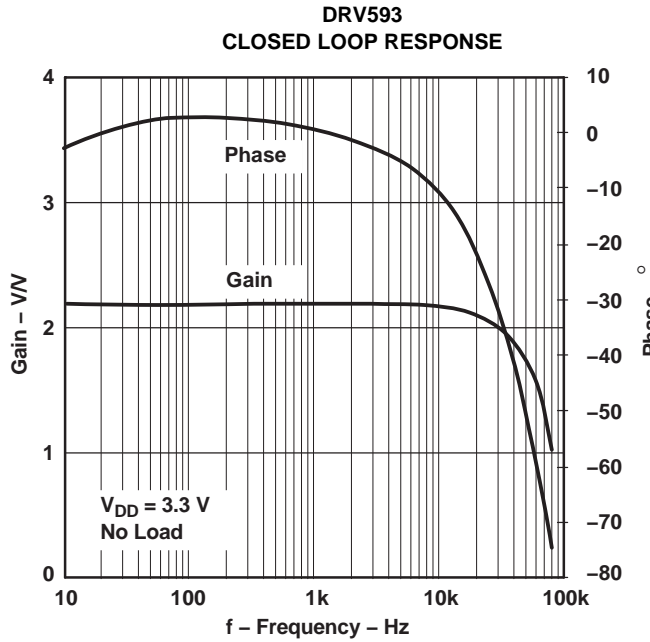

Figure 12.

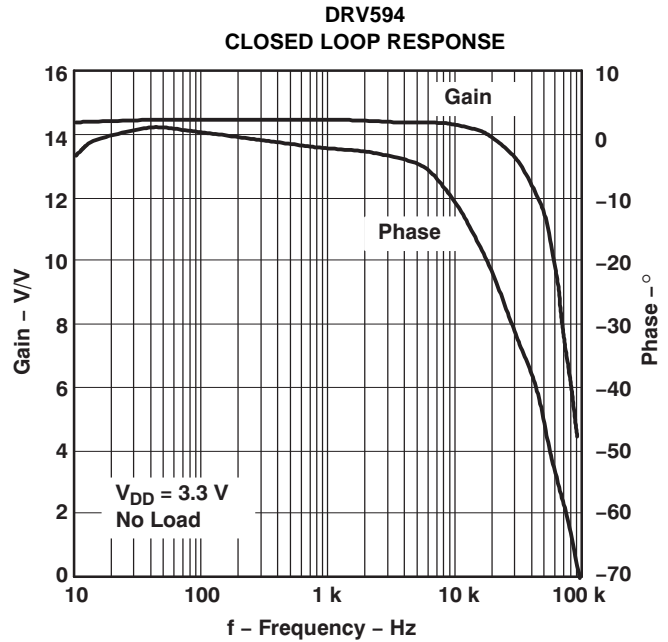

Figure 13.

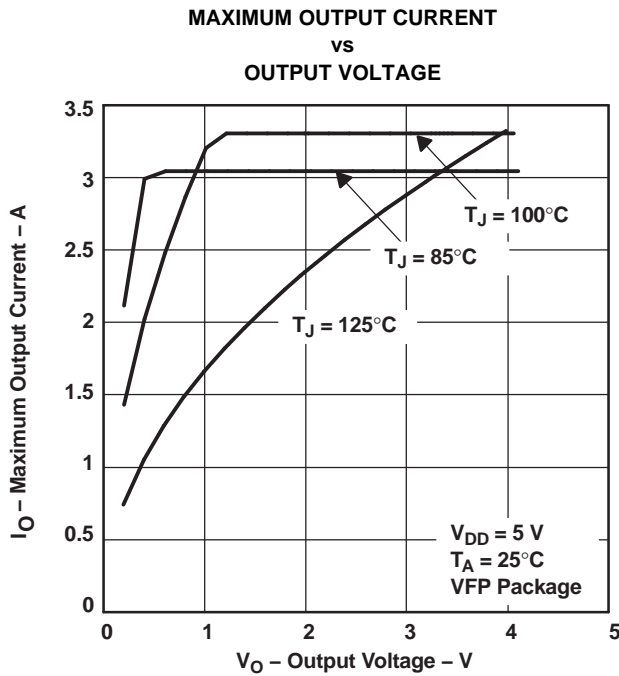

Figure 14.

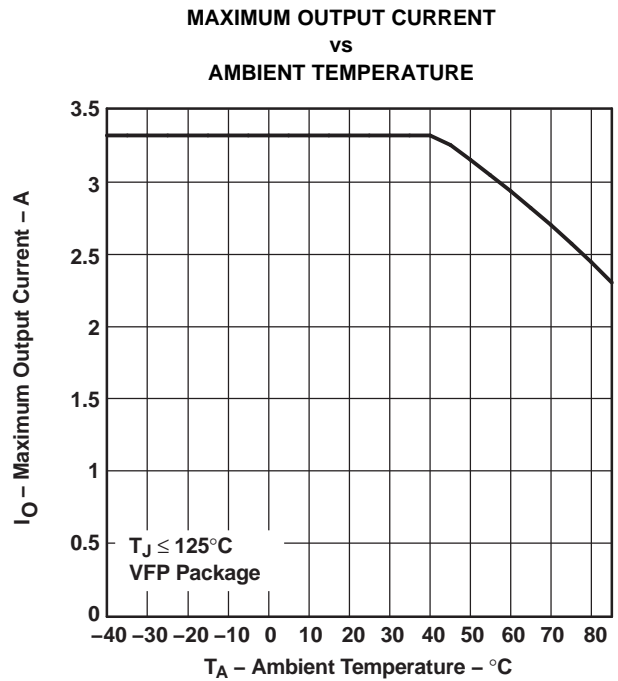

Figure 15.

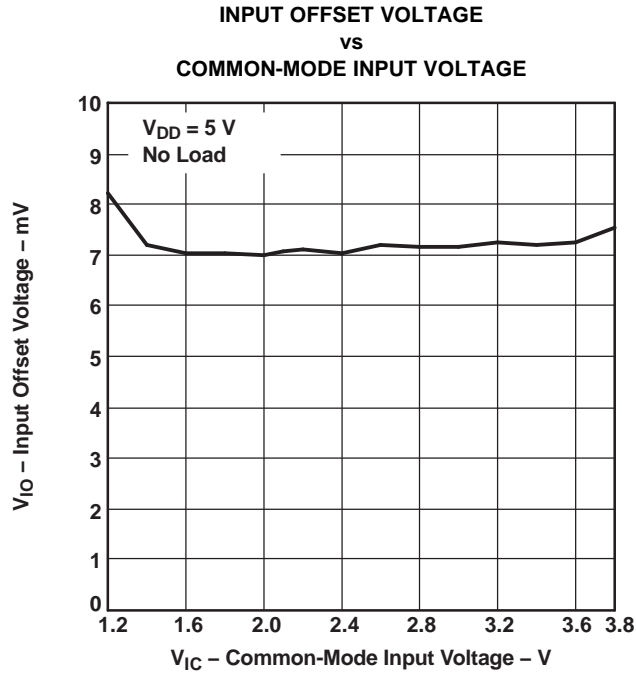

Figure 16.

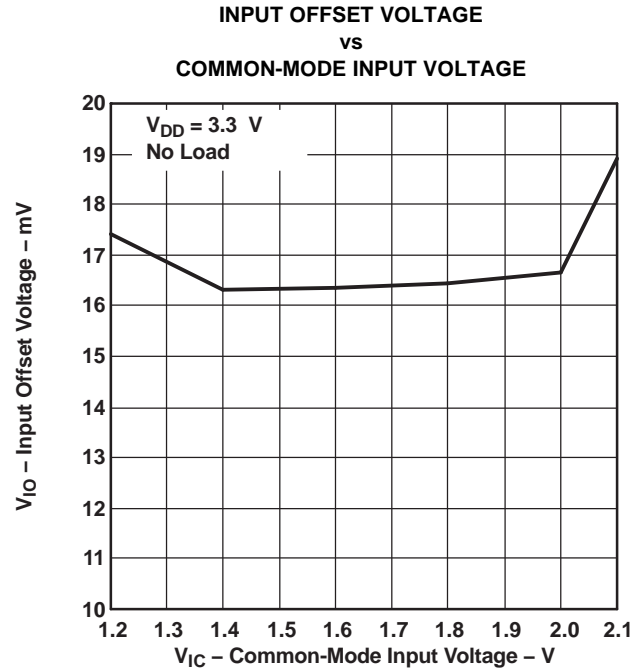

Figure 17.

## APPLICATION INFORMATION

### PULSE-WIDTH MODULATION SCHEME FOR DRV593 AND DRV594

The pulse-width modulation scheme implemented in the DRV593 and DRV594 eliminates one-half of the full output filter previously required for PWM drivers. The DRV593 and DRV594 require only one inductor and capacitor for the output filter. The H/C outputs determine the direction of the current and do not switch back and forth. The PWM outputs switch to produce a voltage across the load that is proportional to the input control voltage.

### COOLING MODE

Figure 18 shows the DRV593 and DRV594 in cooling mode. The H/C outputs (pins 14-17) are at ground and the PWM outputs (pins 24-27) create a voltage across the load that is proportional to the input voltage.

The differential voltage across the load is determined using Equation 1 and the duty cycle using Equation 2. The differential voltage is defined as the voltage measured after the filter on the PWM output relative to the H/C output.

$$V_{\text{Load}} = D \times V_{\text{DD}} \quad (1)$$

$$D = \frac{A_v(V_{\text{IN}+} - V_{\text{IN}-})}{V_{\text{DD}}} \quad (2)$$

where D duty cycle of the PWM signal  $A_v$  Gain of DRV593/594 (DRV593: 2.3 V/V, DRV594: 14.5 V/V)  $V_{\text{IN}+}$  Positive input terminal of the DRV593/594  $V_{\text{IN}-}$  Negative input terminal of the DRV593/594  $V_{\text{DD}}$  Power supply voltage

For example, a 50% duty cycle, shown in Figure 18, results in 2.5 V across the load for  $V_{\text{DD}} = 5 \text{ V}$ .

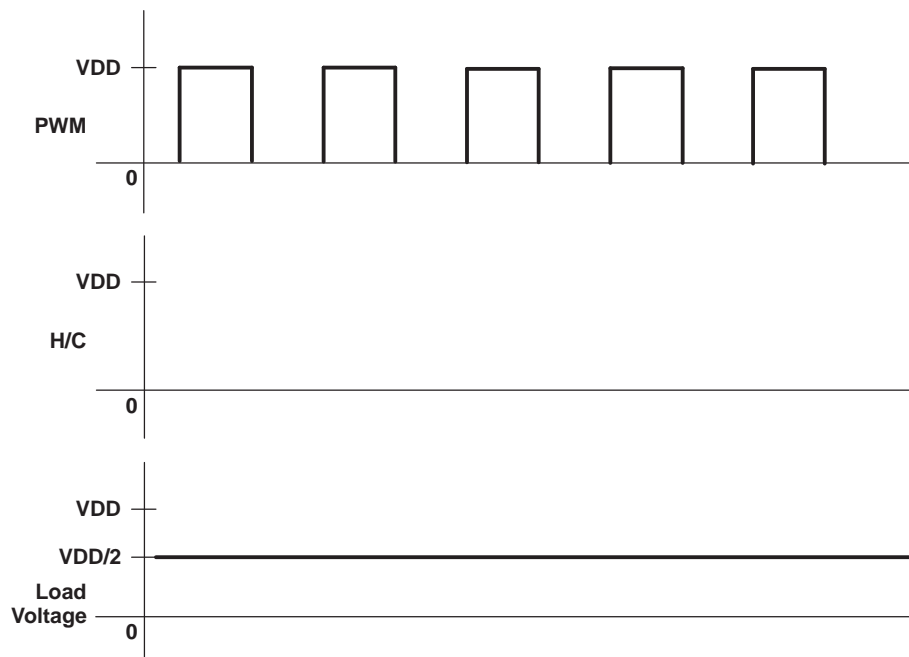

Figure 18. Cooling Mode

## HEATING MODE

Figure 19 shows the DRV593 and DRV594 in heating mode. The H/C output is at VDD and the PWM output is proportional to the voltage across the load.

The differential voltage across the load is determined using Equation 3. The variables are the same as used previously for Equation 1 and Equation 2.

$$V_{\text{Load}} = -(1-D) \times V_{\text{DD}} \quad (3)$$

For example, a 50% duty cycle, shown in Figure 19, results in  $-2.5 \text{ V}$  across the load for  $V_{\text{DD}} = 5 \text{ V}$ . The differential voltage across the load is defined as the voltage measured after the filter on the PWM output relative to the H/C output.

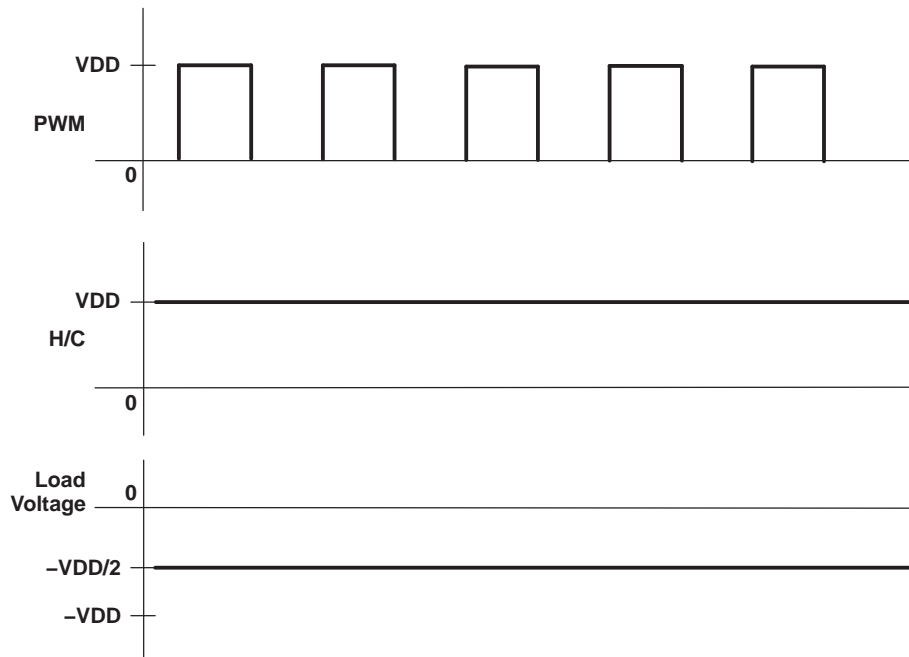

Figure 19. Heating Mode

## HEAT/COOL TRANSITION

As the device transitions from cooling to heating, the duty cycle of the PWM outputs decrease to a small value and the H/C outputs remains at ground. When the device transitions to heating mode, the H/C outputs change from zero volts to VDD and the PWM outputs change to a high duty cycle. The direction of the current flow is reversed, but a low voltage is maintained across the load. The duty cycle decreases as the part is put further into heating mode to drive more current through the load. Figure 20 illustrates the transition from cooling to heating.

## ZERO-CROSSING REGION

When the differential output voltage is near zero, the control logic in the DRV593 and DRV594 causes the outputs to change between heating and cooling modes. There are two possible states for the PWM and H/C outputs to obtain zero volts differentially: both outputs can be at VDD or both outputs can be at ground. Therefore, random noise causes the outputs to change between the two states when the two input voltages are equal. The outputs switch from zero to VDD, although not at a fixed frequency rate. Some of the pulses may be wider than others, but the two outputs (PWM and H/C) track each other to provide zero differential voltage. These uneven pulse widths can increase the switching noise during the zero-crossing condition.

To avoid this phenomenon, hysteresis should be implemented in the control loop to prevent the device from operating within this region. Although planning for operation during the zero-crossing is important, the normal operating points for the DRV593 and DRV594 are outside of this region. For laser temperature/wavelength regulation, the zero volts output condition is only a concern when the laser temperature or wavelength, relative to the ambient temperature, requires no heating or cooling from the TEC element.

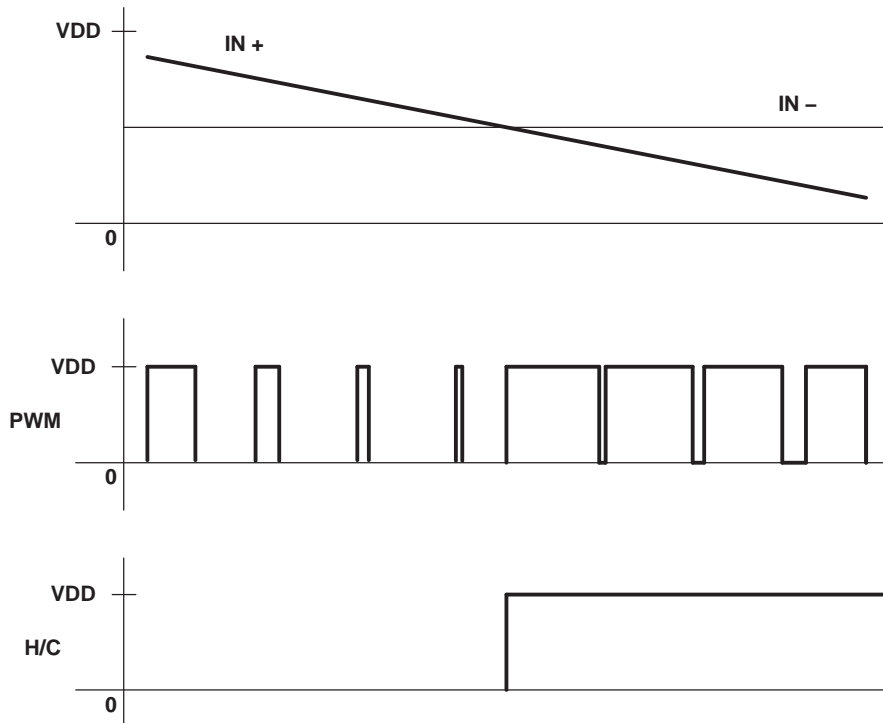

Figure 20. Transition From Cooling to Heating

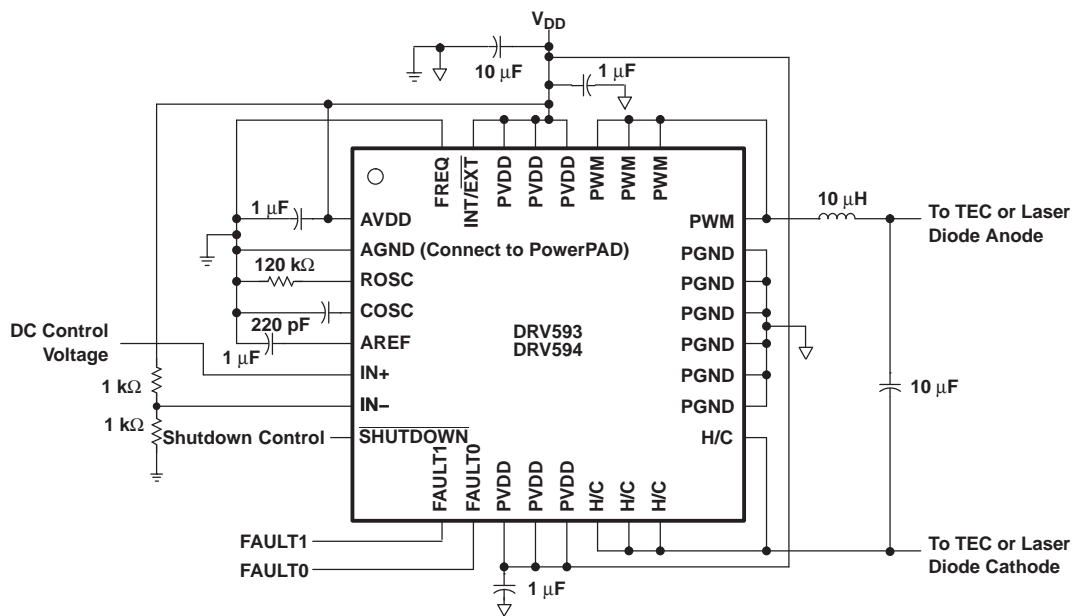

Figure 21. Typical Application Circuit

## OUTPUT FILTER CONSIDERATIONS

TEC element manufacturers provide electrical specifications for maximum dc current and maximum output voltage for each particular element. The maximum ripple current, however, is typically only recommended to be less than 10% with no reference to the frequency components of the current. The maximum temperature differential across the element, which decreases as ripple current increases, may be calculated with the following equation:

$$\Delta T = \frac{1}{(1 + N^2)} \times \Delta T_{\max} \quad (4)$$

where

$\Delta T$  = actual temperature differential

$\Delta T_{\max}$  = maximum temperature differential (specified by manufacturer)

$N$  = ratio of ripple current to dc current

According to this relationship, a 10% ripple current reduces the maximum temperature differential by 1%. An LC network may be used to filter the current flowing to the TEC to reduce the amount of ripple and, more importantly, protect the rest of the system from any electromagnetic interference (EMI).

## FILTER COMPONENT SELECTION

The LC filter, which may be designed from two different perspectives, both described below, helps estimate the overall performance of the system. The filter should be designed for the worst-case conditions during operation, which is typically when the differential output is at 50% duty cycle. The following section serves as a starting point for the design, and any calculations should be confirmed with a prototype circuit in the lab.

Any filter should always be placed as close as possible to the DRV593 and DRV594 to reduce EMI.

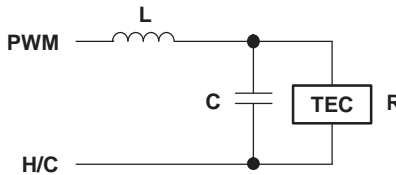

Figure 22. Output Filter

## LC FILTER IN THE FREQUENCY DOMAIN

The transfer function for a second-order low-pass filter (Figure 22) is shown in Equation 5:

$$H_{LP}(j\omega) = \frac{1}{-\left(\frac{\omega}{\omega_0}\right)^2 + \frac{1}{Q} \frac{j\omega}{\omega_0} + 1}$$

$$\omega_0 = \frac{1}{\sqrt{LC}}$$

$Q$  = quality factor

$\omega$  = DRV593 or DRV594 switching frequency

(5)

For the DRV593 and DRV594, the differential output switching frequency is typically selected to be 500 kHz. The resonant frequency for the filter is typically chosen to be at least one order of magnitude lower than the switching frequency. Equation 5 may then be simplified to give the following magnitude Equation 6. These equations assume the use of the filter in Figure 22.

$$\begin{aligned}
 |H_{LP}|_{dB} &= -40 \log \left( \frac{f_s}{f_o} \right) \\
 f_o &= \frac{1}{2\pi\sqrt{LC}} \\
 f_s &= 500 \text{ kHz (DRV593 or DRV594 switching frequency)}
 \end{aligned}
 \tag{6}$$

If  $L=10 \mu\text{H}$  and  $C=10 \mu\text{F}$ , the cutoff frequency is 15.9 kHz, which corresponds to  $-60 \text{ dB}$  of attenuation at the 500 kHz switching frequency. For  $V_{DD} = 5 \text{ V}$ , the amount of ripple voltage at the TEC element is approximately 5 mV.

The average TEC element has a resistance of  $1.5 \Omega$ , so the ripple current through the TEC is approximately 3.4 mA. At the 3-A maximum output current of the DRV593 and DRV594, this 5.4 mA corresponds to 0.11% ripple current, causing less than 0.0001% reduction of the maximum temperature differential of the TEC element (see Equation 4).

### LC FILTER IN THE TIME DOMAIN

The ripple current of an inductor may be calculated using Equation 7:

$$\begin{aligned}
 \Delta I_L &= \frac{(V_O - V_{TEC})DT_s}{L} \\
 D &= \text{duty cycle (0.5 worst case)} \\
 T_s &= 1/f_s = 1/500 \text{ kHz}
 \end{aligned}
 \tag{7}$$

For  $V_O = 5 \text{ V}$ ,  $V_{TEC} = 2.5 \text{ V}$ , and  $L = 10 \mu\text{H}$ , the inductor ripple current is 250 mA. To calculate how much of that ripple current flows through the TEC element, however, the properties of the filter capacitor must be considered.

For relatively small capacitors (less than  $22 \mu\text{F}$ ) with very low equivalent series resistance (ESR, less than  $10 \text{ m}\Omega$ ), such as ceramic capacitors, the following Equation 8 may be used to estimate the ripple voltage on the capacitor due to the change in charge:

$$\begin{aligned}
 \Delta V_C &= \frac{\pi^2}{2} (1-D) \left( \frac{f_o}{f_s} \right)^2 V_{TEC} \\
 D &= \text{duty cycle} \\
 f_s &= 500 \text{ kHz} \\
 f_o &= \frac{1}{2\pi\sqrt{LC}}
 \end{aligned}
 \tag{8}$$

For  $L = 10 \mu\text{H}$  and  $C = 10 \mu\text{F}$ , the cutoff frequency,  $f_o$ , is 15.9 kHz. For worst case duty cycle of 0.5 and  $V_{TEC}=2.5 \text{ V}$ , the ripple voltage on the capacitors is 6.2 mV. The ripple current may be calculated by dividing the ripple voltage by the TEC resistance of  $1.5\Omega$ , resulting in a ripple current through the TEC element of 4.1 mA. Note that this is similar to the value calculated using the frequency domain approach.

For larger capacitors (greater than  $22 \mu\text{F}$ ) with relatively high ESR (greater than  $100 \text{ m}\Omega$ ), such as electrolytic capacitors, the ESR dominates over the charging/discharging of the capacitor. The following simple Equation 9 may be used to estimate the ripple voltage:

$$\begin{aligned}
 \Delta V_C &= \Delta I_L \times R_{ESR} \\
 \Delta I_L &= \text{inductor ripple current} \\
 R_{ESR} &= \text{filter capacitor ESR}
 \end{aligned}
 \tag{9}$$

For a 100  $\mu\text{F}$  electrolytic capacitor, an ESR of 0.1  $\Omega$  is common. If the 10  $\mu\text{H}$  inductor is used, delivering 250 mA of ripple current to the capacitor (as calculated above), then the ripple voltage is 25 mV. This is over ten times that of the 10  $\mu\text{F}$  ceramic capacitor, as ceramic capacitors typically have negligible ESR.

## SWITCHING FREQUENCY CONFIGURATION: OSCILLATOR COMPONENTS $R_{\text{OSC}}$ and $C_{\text{OSC}}$ AND FREQ OPERATION

The onboard ramp generator requires an external resistor and capacitor to set the oscillation frequency. The frequency may be either 500 kHz or 100 kHz by selecting the proper capacitor value and by holding the FREQ pin either low (500 kHz) or high (100 kHz). Table 2 shows the values required and FREQ pin configuration for each switching frequency.

**Table 2. Frequency Configuration Options**

| SWITCHING FREQUENCY | $R_{\text{OSC}}$ | $C_{\text{OSC}}$ | FREQ       |
|---------------------|------------------|------------------|------------|
| 500 kHz             | 120 k $\Omega$   | 220 pF           | LOW (GND)  |
| 100 kHz             | 120 k $\Omega$   | 1 nF             | HIGH (VDD) |

For proper operation, the resistor  $R_{\text{OSC}}$  should have 1% tolerance while capacitor  $C_{\text{OSC}}$  should be a ceramic type with 10% tolerance. Both components should be grounded to AGND, which should be connected to PGND at a single point, typically where power and ground are physically connected to the printed-circuit board.

## EXTERNAL CLOCKING OPERATION

To synchronize the switching to an external clock signal, pull the  $\overline{\text{INT/EXT}}$  terminal low, and drive the clock signal into the COSC terminal. This clock signal must be from 10% to 90% duty cycle and meet the voltage requirements specified in the electrical specifications table. Since the DRV593 and DRV594 include an internal frequency doubler, the external clock signal must be approximately 250 kHz. Deviations from the 250 kHz clock frequency are allowed and are specified in the electrical characteristic table. The resistor connected from ROSC to ground may be omitted from the circuit in this mode of operation—the source is disconnected internally.

## INPUT CONFIGURATION: DIFFERENTIAL AND SINGLE-ENDED

If a differential input is used, it should be biased around the midrail of the DRV593 or DRV594 and must not exceed the common-mode input range of the input stage (see the operating characteristics at the beginning of the data sheet).

The most common configuration employs a single-ended input. The unused input should be tied to  $V_{\text{DD}}/2$ , which may be simply accomplished with a resistive voltage divider. For the best performance, the resistor values chosen should be at least 100 times lower than the input resistance of the DRV593 or DRV594. This prevents the bias voltage at the unused input from shifting when the signal input is applied. A small ceramic capacitor should also be placed from the input to ground to filter noise and keep the voltage stable. An op amp configured as a buffer may also be used to set the voltage at the unused input.

## FIXED INTERNAL GAIN

The differential output voltage may be calculated using Equation 10:

$$V_{\text{O}} = V_{\text{OUT}+} - V_{\text{OUT}-} = A_{\text{V}}(V_{\text{IN}+} - V_{\text{IN}-}) \quad (10)$$

$A_{\text{V}}$  is the voltage gain, which is fixed internally at 2.3 V/V for DRV593 and 14.5 V/V for DRV594. The maximum and minimum ratings are provided in the electrical specification table at the beginning of the data sheet.

## POWER SUPPLY DECOUPLING

To reduce the effects of high-frequency transients or spikes, a small ceramic capacitor, typically 0.1  $\mu\text{F}$  to 1  $\mu\text{F}$ , should be placed as close to each set of PVDD pins of the DRV593 and DRV594 as possible. For bulk decoupling, a 10  $\mu\text{F}$  to 100  $\mu\text{F}$  tantalum or aluminum electrolytic capacitor should be placed relatively close to the DRV593 and DRV594.



## AREF CAPACITOR

The AREF terminal is the output of an internal mid-rail voltage regulator used for the onboard oscillator and ramp generator. The regulator may not be used to provide power to any additional circuitry. A 1  $\mu$ F ceramic capacitor must be connected from AREF to AGND for stability (see oscillator components above for AGND connection information).

## SHUTDOWN OPERATION

The DRV593 and DRV594 include a shutdown mode that disables the outputs and places the device in a low supply current state. The SHUTDOWN pin may be controlled with a TTL logic signal. When SHUTDOWN is held high, the device operates normally. When SHUTDOWN is held low, the device is placed in shutdown. The SHUTDOWN pin must not be left floating. If the shutdown feature is unused, the pin may be connected to VDD.

## FAULT REPORTING

The DRV593 and DRV594 include circuitry to sense three faults:

- Overcurrent
- Undervoltage
- Overtemperature

These three fault conditions are decoded via the FAULT1 and FAULT0 terminals. Internally, these are open-drain outputs, so an external pullup resistor of 5 k $\Omega$  or greater is required.

**Table 3. Fault Indicators**

| FAULT1 | FAULT0 |                  |
|--------|--------|------------------|
| 0      | 0      | Overcurrent      |
| 1      | 0      | Undervoltage     |
| 0      | 1      | Overtemperature  |
| 1      | 1      | Normal operation |

The overcurrent fault is reported when the output current exceeds four amps. As soon as the condition is sensed, the overcurrent fault is set and the outputs go into a high-impedance state for approximately 3  $\mu$ s to 5  $\mu$ s (500 kHz operation). After 3  $\mu$ s to 5  $\mu$ s, the outputs are re-enabled. If the overcurrent condition has ended, the fault is cleared and the device resumes normal operation. If the overcurrent condition still exists, the above sequence repeats.

The undervoltage fault is reported when the operating voltage is reduced below 2.8 V. This fault is not latched, so as soon as the power supply recovers, the fault is cleared and normal operation resumes. During the undervoltage condition, the outputs go into a high-impedance state to prevent overdissipation due to increased  $r_{DS(on)}$ .

The overtemperature fault is reported when the junction temperature exceeds 128°C. The device continues operating normally until the junction temperature reaches 158°C, at which point the IC is disabled to prevent permanent damage from occurring. The system's controller must reduce the power demanded from the DRV593 or DRV594 once the overtemperature flag is set, or else the device switches off when it reaches 158°C. This fault is not latched; once the junction temperature drops below 128°C, the fault is cleared, and normal operation resumes.

## POWER DISSIPATION AND MAXIMUM AMBIENT TEMPERATURE

Though the DRV593 and DRV594 are much more efficient than traditional linear solutions, the power drop across the on-resistance of the output transistors does generate some heat in the package, which may be calculated as shown in [Equation 11](#):

$$P_{DISS} = (I_{OUT})^2 \times r_{DS(on), total} \quad (11)$$

For example, at the maximum output current of 3 A through a total on-resistance of 130 m $\Omega$  (at  $T_J = 25^\circ\text{C}$ ), the power dissipated in the package is 1.17 W.

Calculate the maximum ambient temperature using [Equation 12](#):

$$T_A = T_J - (\theta_{JA} \times P_{DISS}) \quad (12)$$

## PRINTED-CIRCUIT BOARD (PCB) LAYOUT CONSIDERATIONS

Since the DRV593 and DRV594 are high-current switching devices, a few guidelines for the layout of the printed-circuit board (PCB) must be considered:

1. **Grounding.** Analog ground (AGND) and power ground (PGND) must be kept separated, ideally back to where the power supply physically connects to the PCB, minimally back to the bulk decoupling capacitor (10  $\mu$ F ceramic minimum). Furthermore, the PowerPAD ground connection should be made to AGND, not PGND. Ground planes are not recommended for AGND or PGND, traces should be used to route the currents. Wide traces (100 mils) should be used for PGND while narrow traces (15 mils) should be used for AGND.
2. **Power supply decoupling.** A small 0.1  $\mu$ F to 1  $\mu$ F ceramic capacitor should be placed as close to each set of PVDD pins as possible, connecting from PVDD to PGND. A 0.1  $\mu$ F to 1  $\mu$ F ceramic capacitor should also be placed close to the AVDD pin, connecting from AVDD to AGND. A bulk decoupling capacitor of at least 10  $\mu$ F, preferably ceramic, should be placed close to the DRV593 or DRV594, from PVDD to PGND. If power supply lines are long, additional decoupling may be required.
3. **Power and output traces.** The power and output traces should be sized to handle the desired maximum output current. The output traces should be kept as short as possible to reduce EMI, i.e., the output filter should be placed as close to the DRV593 or DRV594 outputs as possible.
4. **PowerPAD.** The DRV593 and DRV594 in the Quad Flatpack package use TI's PowerPAD technology to enhance the thermal performance. The PowerPAD is physically connected to the substrate of the DRV593 and DRV594 silicon, which is connected to AGND. The PowerPAD ground connection should therefore be kept separate from PGND as described above. The pad underneath the AGND pin may be connected underneath the device to the PowerPAD ground connection for ease of routing. For additional information on PowerPAD PCB layout, refer to the *PowerPAD Thermally Enhanced Package* application note, ([SLMA002](#)).
5. **Thermal performance.** For proper thermal performance, the PowerPAD must be soldered down to a thermal land, as described in the *PowerPAD Thermally Enhanced Package* application note, ([SLMA002](#)). In addition, at high current levels (greater than 2 A) or high ambient temperatures (greater than 25°C), an internal plane may be used for heat sinking. The vias under the PowerPAD should make a solid connection, and the plane should not be tied to ground except through the PowerPAD connection, as described above.

---

**Changes from Revision A (October 2002) to Revision B****Page**

- Changed Thermal trip point from 115°C to 128°C ..... 3
  - Changed Thermal shutdown point from 128°C to 158°C ..... 3
- 

**Changes from Revision B (November 2008) to Revision C****Page**

- Changed figure cross reference from "Figure 17 and Figure 18" to "Figure 22" in the "LC FILTER....." section. .... 14
-

## PACKAGING INFORMATION

| Orderable Device | Status<br>(1) | Package Type | Package<br>Drawing | Pins | Package<br>Qty | Eco Plan<br>(2)            | Lead/Ball Finish<br>(6) | MSL Peak Temp<br>(3) | Op Temp (°C) | Device Marking<br>(4/5) | Samples                 |
|------------------|---------------|--------------|--------------------|------|----------------|----------------------------|-------------------------|----------------------|--------------|-------------------------|-------------------------|
| DRV593VFP        | ACTIVE        | HLQFP        | VFP                | 32   | 250            | Green (RoHS<br>& no Sb/Br) | CU NIPDAU               | Level-2-260C-1 YEAR  | -40 to 85    | DRV593                  | <a href="#">Samples</a> |
| DRV593VFPR       | ACTIVE        | HLQFP        | VFP                | 32   | 1000           | Green (RoHS<br>& no Sb/Br) | CU NIPDAU               | Level-2-260C-1 YEAR  | -40 to 85    | DRV593                  | <a href="#">Samples</a> |
| DRV594VFP        | ACTIVE        | HLQFP        | VFP                | 32   | 250            | Green (RoHS<br>& no Sb/Br) | CU NIPDAU               | Level-2-260C-1 YEAR  | -40 to 85    | DRV594                  | <a href="#">Samples</a> |
| DRV594VFPR       | ACTIVE        | HLQFP        | VFP                | 32   | 1000           | Green (RoHS<br>& no Sb/Br) | CU NIPDAU               | Level-2-260C-1 YEAR  | -40 to 85    | DRV594                  | <a href="#">Samples</a> |

(1) The marketing status values are defined as follows:

**ACTIVE:** Product device recommended for new designs.

**LIFEBUY:** TI has announced that the device will be discontinued, and a lifetime-buy period is in effect.

**NRND:** Not recommended for new designs. Device is in production to support existing customers, but TI does not recommend using this part in a new design.

**PREVIEW:** Device has been announced but is not in production. Samples may or may not be available.

**OBSOLETE:** TI has discontinued the production of the device.

(2) Eco Plan - The planned eco-friendly classification: Pb-Free (RoHS), Pb-Free (RoHS Exempt), or Green (RoHS & no Sb/Br) - please check <http://www.ti.com/productcontent> for the latest availability information and additional product content details.

**TBD:** The Pb-Free/Green conversion plan has not been defined.

**Pb-Free (RoHS):** TI's terms "Lead-Free" or "Pb-Free" mean semiconductor products that are compatible with the current RoHS requirements for all 6 substances, including the requirement that lead not exceed 0.1% by weight in homogeneous materials. Where designed to be soldered at high temperatures, TI Pb-Free products are suitable for use in specified lead-free processes.

**Pb-Free (RoHS Exempt):** This component has a RoHS exemption for either 1) lead-based flip-chip solder bumps used between the die and package, or 2) lead-based die adhesive used between the die and leadframe. The component is otherwise considered Pb-Free (RoHS compatible) as defined above.

**Green (RoHS & no Sb/Br):** TI defines "Green" to mean Pb-Free (RoHS compatible), and free of Bromine (Br) and Antimony (Sb) based flame retardants (Br or Sb do not exceed 0.1% by weight in homogeneous material)

(3) MSL, Peak Temp. - The Moisture Sensitivity Level rating according to the JEDEC industry standard classifications, and peak solder temperature.

(4) There may be additional marking, which relates to the logo, the lot trace code information, or the environmental category on the device.

(5) Multiple Device Markings will be inside parentheses. Only one Device Marking contained in parentheses and separated by a "~" will appear on a device. If a line is indented then it is a continuation of the previous line and the two combined represent the entire Device Marking for that device.

(6) Lead/Ball Finish - Orderable Devices may have multiple material finish options. Finish options are separated by a vertical ruled line. Lead/Ball Finish values may wrap to two lines if the finish value exceeds the maximum column width.

**Important Information and Disclaimer:** The information provided on this page represents TI's knowledge and belief as of the date that it is provided. TI bases its knowledge and belief on information provided by third parties, and makes no representation or warranty as to the accuracy of such information. Efforts are underway to better integrate information from third parties. TI has taken and continues to take reasonable steps to provide representative and accurate information but may not have conducted destructive testing or chemical analysis on incoming materials and chemicals. TI and TI suppliers consider certain information to be proprietary, and thus CAS numbers and other limited information may not be available for release.

In no event shall TI's liability arising out of such information exceed the total purchase price of the TI part(s) at issue in this document sold by TI to Customer on an annual basis.

**TAPE AND REEL INFORMATION**
**REEL DIMENSIONS**

**TAPE DIMENSIONS**

|    |   |
|----|---|
| A0 | Dimension designed to accommodate the component width     |
| B0 | Dimension designed to accommodate the component length    |
| K0 | Dimension designed to accommodate the component thickness |
| W  | Overall width of the carrier tape                         |
| P1 | Pitch between successive cavity centers                   |

**TAPE AND REEL INFORMATION**

\*All dimensions are nominal

| Device     | Package Type | Package Drawing | Pins | SPQ  | Reel Diameter (mm) | Reel Width W1 (mm) | A0 (mm) | B0 (mm) | K0 (mm) | P1 (mm) | W (mm) | Pin1 Quadrant |
|------------|--------------|-----------------|------|------|--------------------|--------------------|---------|---------|---------|---------|--------|---------------|
| DRV593VFPR | HLQFP        | VFP             | 32   | 1000 | 330.0              | 16.4               | 9.6     | 9.6     | 1.9     | 12.0    | 16.0   | Q2            |
| DRV594VFPR | HLQFP        | VFP             | 32   | 1000 | 330.0              | 16.4               | 9.6     | 9.6     | 1.9     | 12.0    | 16.0   | Q2            |

**TAPE AND REEL BOX DIMENSIONS**



\*All dimensions are nominal

| Device     | Package Type | Package Drawing | Pins | SPQ  | Length (mm) | Width (mm) | Height (mm) |
|------------|--------------|-----------------|------|------|-------------|------------|-------------|
| DRV593VFPR | HLQFP        | VFP             | 32   | 1000 | 367.0       | 367.0      | 38.0        |
| DRV594VFPR | HLQFP        | VFP             | 32   | 1000 | 367.0       | 367.0      | 38.0        |

## GENERIC PACKAGE VIEW

VFP 32

PowerPAD™ LQFP - 1.6 mm max height

PLASTIC QUAD FLATPACK

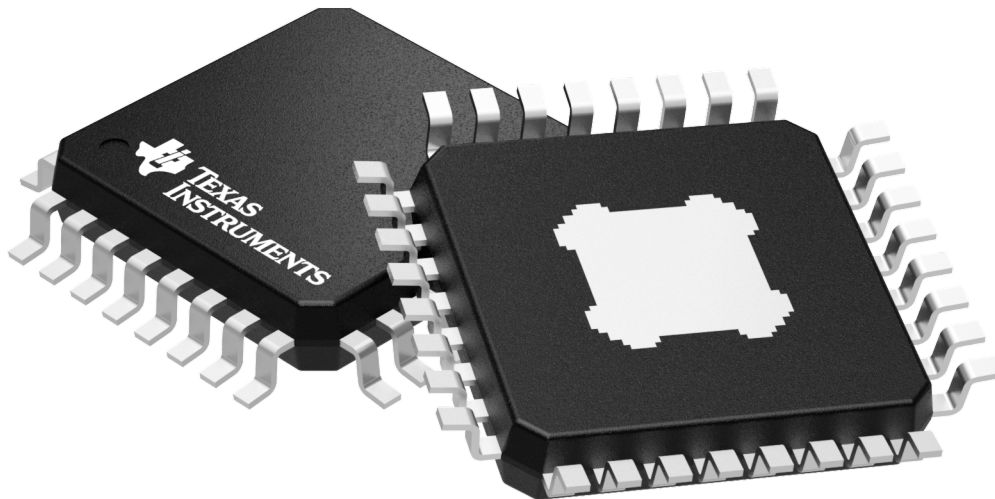

Images above are just a representation of the package family, actual package may vary.  
Refer to the product data sheet for package details.

4200791/D



# THERMAL PAD MECHANICAL DATA

VFP (S-PQFP-G32)

PowerPAD™ PLASTIC QUAD FLATPACK

## THERMAL INFORMATION

This PowerPAD™ package incorporates an exposed thermal pad that is designed to be attached to a printed circuit board (PCB). The thermal pad must be soldered directly to the PCB. After soldering, the PCB can be used as a heatsink. In addition, through the use of thermal vias, the thermal pad can be attached directly to the appropriate copper plane shown in the electrical schematic for the device, or alternatively, can be attached to a special heatsink structure designed into the PCB. This design optimizes the heat transfer from the integrated circuit (IC).

For additional information on the PowerPAD package and how to take advantage of its heat dissipating abilities, refer to Technical Brief, PowerPAD Thermally Enhanced Package, Texas Instruments Literature No. SLMA002 and Application Brief, PowerPAD Made Easy, Texas Instruments Literature No. SLMA004. Both documents are available at [www.ti.com](http://www.ti.com).

The exposed thermal pad dimensions for this package are shown in the following illustration.

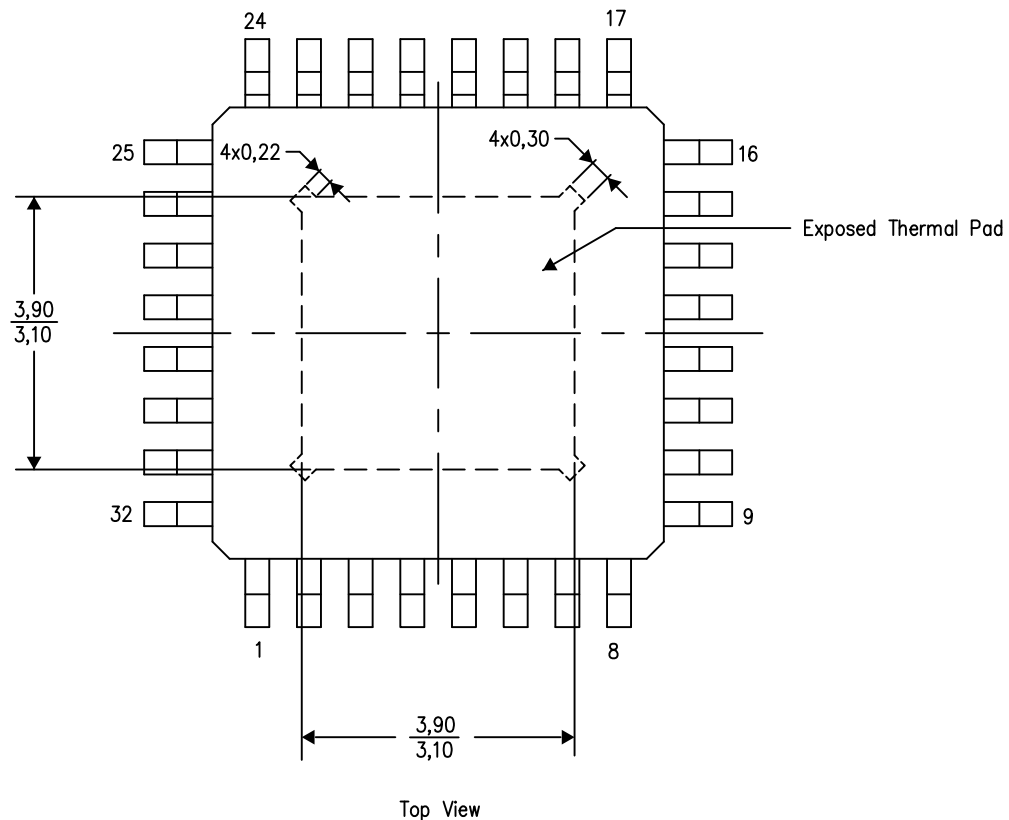

Exposed Thermal Pad Dimensions

4206318-2/E 06/13

NOTE: All linear dimensions are in millimeters

## VFP (S-PQFP-G32) PowerPAD™

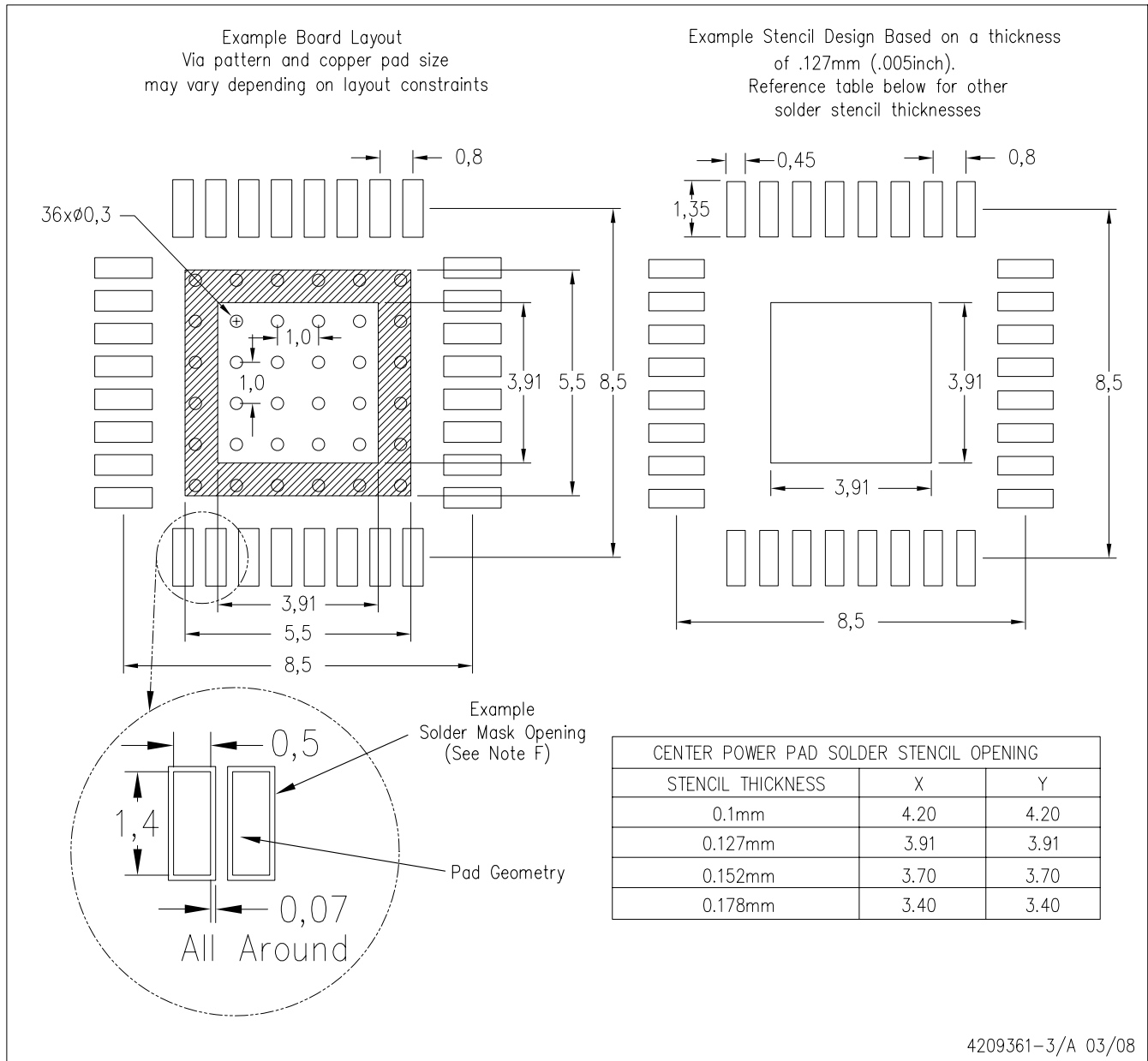

- NOTES:
- All linear dimensions are in millimeters.
  - This drawing is subject to change without notice.
  - Customers should place a note on the circuit board fabrication drawing not to alter the center solder mask defined pad.
  - This package is designed to be soldered to a thermal pad on the board. Refer to Technical Brief, PowerPAD Thermally Enhanced Package, Texas Instruments Literature No. SLMA002, SLMA004, and also the Product Data Sheets for specific thermal information, via requirements, and recommended board layout. These documents are available at [www.ti.com](http://www.ti.com) <<http://www.ti.com>>. Publication IPC-7351 is recommended for alternate designs.
  - Laser cutting apertures with trapezoidal walls and also rounding corners will offer better paste release. Customers should contact their board assembly site for stencil design recommendations. Example stencil design based on a 50% volumetric metal load solder paste. Refer to IPC-7525 for other stencil recommendations.
  - Customers should contact their board fabrication site for solder mask tolerances between and around signal pads.

PowerPAD is a trademark of Texas Instruments.

## IMPORTANT NOTICE

Texas Instruments Incorporated (TI) reserves the right to make corrections, enhancements, improvements and other changes to its semiconductor products and services per JESD46, latest issue, and to discontinue any product or service per JESD48, latest issue. Buyers should obtain the latest relevant information before placing orders and should verify that such information is current and complete.

TI's published terms of sale for semiconductor products (<http://www.ti.com/sc/docs/stdterms.htm>) apply to the sale of packaged integrated circuit products that TI has qualified and released to market. Additional terms may apply to the use or sale of other types of TI products and services.

Reproduction of significant portions of TI information in TI data sheets is permissible only if reproduction is without alteration and is accompanied by all associated warranties, conditions, limitations, and notices. TI is not responsible or liable for such reproduced documentation. Information of third parties may be subject to additional restrictions. Resale of TI products or services with statements different from or beyond the parameters stated by TI for that product or service voids all express and any implied warranties for the associated TI product or service and is an unfair and deceptive business practice. TI is not responsible or liable for any such statements.

Buyers and others who are developing systems that incorporate TI products (collectively, "Designers") understand and agree that Designers remain responsible for using their independent analysis, evaluation and judgment in designing their applications and that Designers have full and exclusive responsibility to assure the safety of Designers' applications and compliance of their applications (and of all TI products used in or for Designers' applications) with all applicable regulations, laws and other applicable requirements. Designer represents that, with respect to their applications, Designer has all the necessary expertise to create and implement safeguards that (1) anticipate dangerous consequences of failures, (2) monitor failures and their consequences, and (3) lessen the likelihood of failures that might cause harm and take appropriate actions. Designer agrees that prior to using or distributing any applications that include TI products, Designer will thoroughly test such applications and the functionality of such TI products as used in such applications.

TI's provision of technical, application or other design advice, quality characterization, reliability data or other services or information, including, but not limited to, reference designs and materials relating to evaluation modules, (collectively, "TI Resources") are intended to assist designers who are developing applications that incorporate TI products; by downloading, accessing or using TI Resources in any way, Designer (individually or, if Designer is acting on behalf of a company, Designer's company) agrees to use any particular TI Resource solely for this purpose and subject to the terms of this Notice.

TI's provision of TI Resources does not expand or otherwise alter TI's applicable published warranties or warranty disclaimers for TI products, and no additional obligations or liabilities arise from TI providing such TI Resources. TI reserves the right to make corrections, enhancements, improvements and other changes to its TI Resources. TI has not conducted any testing other than that specifically described in the published documentation for a particular TI Resource.

Designer is authorized to use, copy and modify any individual TI Resource only in connection with the development of applications that include the TI product(s) identified in such TI Resource. NO OTHER LICENSE, EXPRESS OR IMPLIED, BY ESTOPPEL OR OTHERWISE TO ANY OTHER TI INTELLECTUAL PROPERTY RIGHT, AND NO LICENSE TO ANY TECHNOLOGY OR INTELLECTUAL PROPERTY RIGHT OF TI OR ANY THIRD PARTY IS GRANTED HEREIN, including but not limited to any patent right, copyright, mask work right, or other intellectual property right relating to any combination, machine, or process in which TI products or services are used. Information regarding or referencing third-party products or services does not constitute a license to use such products or services, or a warranty or endorsement thereof. Use of TI Resources may require a license from a third party under the patents or other intellectual property of the third party, or a license from TI under the patents or other intellectual property of TI.

TI RESOURCES ARE PROVIDED "AS IS" AND WITH ALL FAULTS. TI DISCLAIMS ALL OTHER WARRANTIES OR REPRESENTATIONS, EXPRESS OR IMPLIED, REGARDING RESOURCES OR USE THEREOF, INCLUDING BUT NOT LIMITED TO ACCURACY OR COMPLETENESS, TITLE, ANY EPIDEMIC FAILURE WARRANTY AND ANY IMPLIED WARRANTIES OF MERCHANTABILITY, FITNESS FOR A PARTICULAR PURPOSE, AND NON-INFRINGEMENT OF ANY THIRD PARTY INTELLECTUAL PROPERTY RIGHTS. TI SHALL NOT BE LIABLE FOR AND SHALL NOT DEFEND OR INDEMNIFY DESIGNER AGAINST ANY CLAIM, INCLUDING BUT NOT LIMITED TO ANY INFRINGEMENT CLAIM THAT RELATES TO OR IS BASED ON ANY COMBINATION OF PRODUCTS EVEN IF DESCRIBED IN TI RESOURCES OR OTHERWISE. IN NO EVENT SHALL TI BE LIABLE FOR ANY ACTUAL, DIRECT, SPECIAL, COLLATERAL, INDIRECT, PUNITIVE, INCIDENTAL, CONSEQUENTIAL OR EXEMPLARY DAMAGES IN CONNECTION WITH OR ARISING OUT OF TI RESOURCES OR USE THEREOF, AND REGARDLESS OF WHETHER TI HAS BEEN ADVISED OF THE POSSIBILITY OF SUCH DAMAGES.

Unless TI has explicitly designated an individual product as meeting the requirements of a particular industry standard (e.g., ISO/TS 16949 and ISO 26262), TI is not responsible for any failure to meet such industry standard requirements.

Where TI specifically promotes products as facilitating functional safety or as compliant with industry functional safety standards, such products are intended to help enable customers to design and create their own applications that meet applicable functional safety standards and requirements. Using products in an application does not by itself establish any safety features in the application. Designers must ensure compliance with safety-related requirements and standards applicable to their applications. Designer may not use any TI products in life-critical medical equipment unless authorized officers of the parties have executed a special contract specifically governing such use. Life-critical medical equipment is medical equipment where failure of such equipment would cause serious bodily injury or death (e.g., life support, pacemakers, defibrillators, heart pumps, neurostimulators, and implantables). Such equipment includes, without limitation, all medical devices identified by the U.S. Food and Drug Administration as Class III devices and equivalent classifications outside the U.S.

TI may expressly designate certain products as completing a particular qualification (e.g., Q100, Military Grade, or Enhanced Product). Designers agree that it has the necessary expertise to select the product with the appropriate qualification designation for their applications and that proper product selection is at Designers' own risk. Designers are solely responsible for compliance with all legal and regulatory requirements in connection with such selection.

Designer will fully indemnify TI and its representatives against any damages, costs, losses, and/or liabilities arising out of Designer's non-compliance with the terms and provisions of this Notice.