



Interference Suppression Film Capacitor - Class X2 Radial MKT 310 V_{AC} - High Stability Grade



FEATURES

- 15 mm to 37.5 mm lead pitch
- Internal series construction
- AEC-Q200 qualified for C ≤ 470 nF
- Material categorization:
for definitions of compliance please see www.vishay.com/doc?99912



APPLICATIONS

High stability grade for continuous across the line X2 applications.

See also application note: www.vishay.com/doc?28153

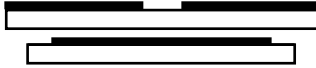
QUICK REFERENCE DATA	
Capacitance range (E12 series)	0.01 µF to 2.2 µF (preferred values acc. to E6)
Capacitance tolerance	± 10 %, ± 20 % (± 5 % on request)
Rated AC voltage	310 V _{AC} ; 50 Hz to 60 Hz
Permissible DC voltage	800 V _{DC} at 85 °C 630 V _{DC} at 110 °C
Climatic testing class according to IEC 60068-1	40/110/56/C
Maximum application temperature	110 °C
Reference standards	IEC 60384-14 ed-4 and EN 60384-14 IEC 60065 pass. flamm. class C CSA-E384-14 UL 60384-14
Dielectric	Polyester film
Electrodes	Metallized
Construction	Series construction 
Encapsulation	Plastic case, epoxy resin sealed, flame retardant UL-class 94 V-0
Leads	Tinned wire
Marking	C-value; tolerance; rated voltage; sub-class; manufacturer's type; code for dielectric material; manufacturer location, year and week; manufacturer's logo or name; safety approvals

Note

- For more detailed data and test requirements, contact rfi@vishay.com

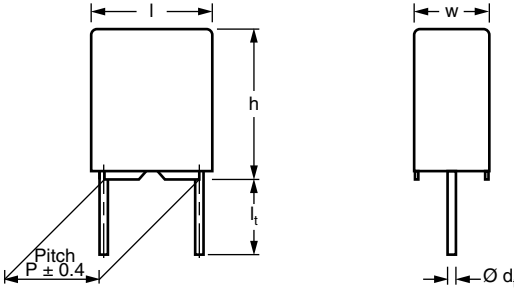
DIMENSIONS in millimeters

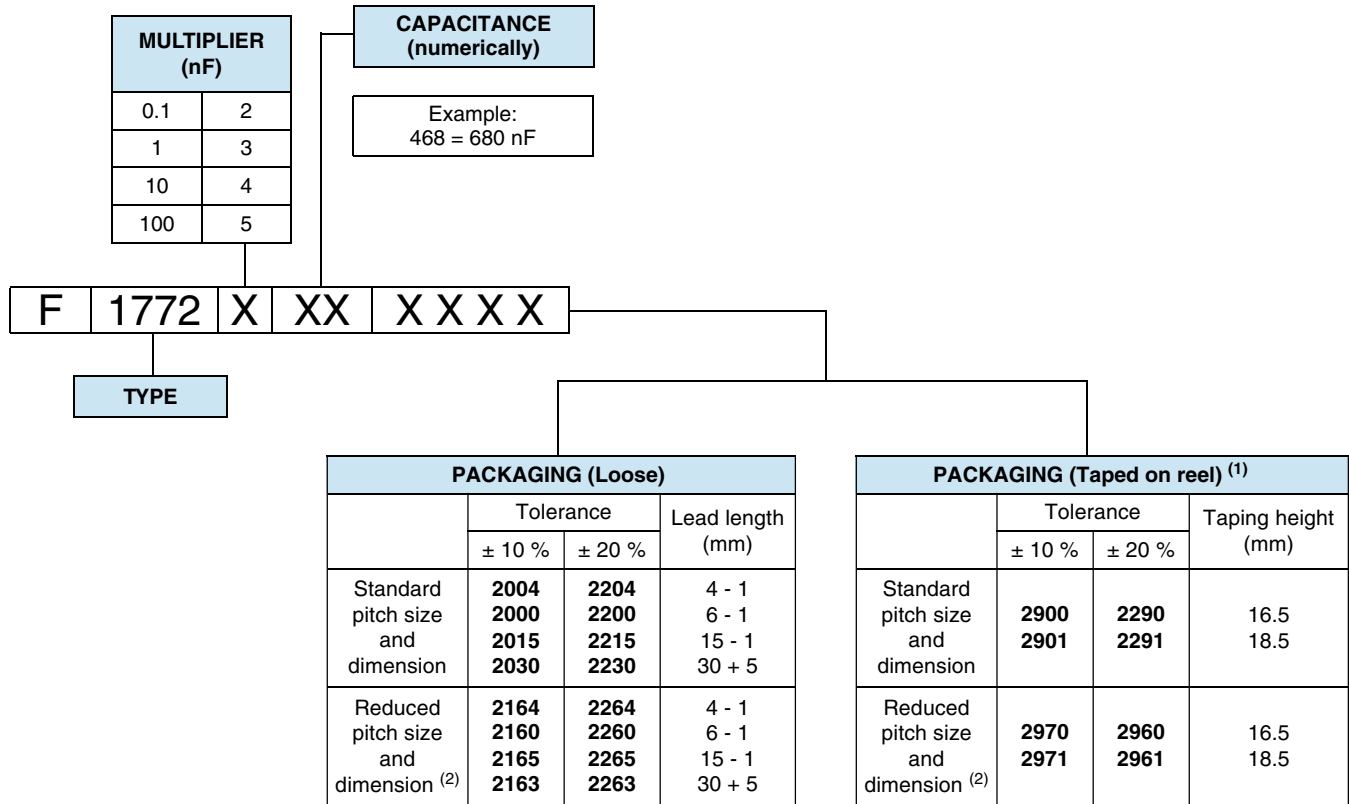
COMPOSITION OF CATALOG NUMBER

Example: F17724152215 means 0.15 µF, ± 20 %; standard pitch 22.5 mm; lead length 15 mm - 1 mm;
 F17724152265 means 0.15 µF, ± 20 %; reduced pitch 15.0 mm; lead length 15 mm - 1 mm

Notes

- For detailed tape specifications refer to packaging information www.vishay.com/doc?28139
- ⁽¹⁾ Taped on reel pitch ≥ 27.5 mm is not available
- ⁽²⁾ Same capacitance values ≥ 0.15 µF are available in two different pitch sizes and dimensions

SPECIFIC REFERENCE DATA	
DESCRIPTION	VALUE
Rated AC voltage (U _{RAC})	310 V
Permissible DC voltage (U _{RDC})	630 V
Tangent of loss angle	≤ 100 × 10 ⁻⁴ at 1 kHz
Rated voltage pulse slope at (dU/dt) _R 435 V _{DC}	100 V/µs
R between leads, for C ≤ 0.33 µF at 100 V; 1 min	> 15 000 MΩ
RC between leads, C > 0.33 µF at 100 V; 1 min	> 5000 s
R between leads and case; 100 V; 1 min	> 30 000 MΩ
Withstanding (DC) voltage (cut off current 10 mA) ⁽¹⁾ ; rise time ≤ 1000 V/s	
C ≤ 0.47 µF	2200 V; for 1 min
C > 0.47 µF	2150 V; for 1 min
Withstanding (AC) voltage between leads and case	2120 V; 1 min
Maximum application temperature	110 °C

Note

- See "Voltage Proof Test for Metalized Film Capacitors": www.vishay.com/doc?28169



ELECTRICAL DATA AND ORDERING INFORMATION						
U_{RAC} (V)	CAP. (μF)	PITCH (mm)	DIMENSIONS ⁽⁴⁾ w x h x l MAX. (mm)	MASS ⁽³⁾ (g)	SPQ (pieces) SHORT LEAD	ORDERING CODE BULK LEAD LENGTH 6 mm - 1 mm ⁽¹⁾⁽²⁾
310	d_t = 0.60 mm ± 0.06 mm; C-TOL. = ± 10 %					
	0.010	15	5.0 x 11.0 x 17.5	1.4	750	F17723102000
	0.012	15	5.0 x 11.0 x 17.5	1.4	750	F17723122000
	0.015	15	5.0 x 11.0 x 17.5	1.4	750	F17723152000
	0.018	15	5.0 x 11.0 x 17.5	1.4	750	F17723182000
	0.022	15	5.0 x 11.0 x 17.5	1.4	750	F17723222000
	0.027	15	5.0 x 11.0 x 17.5	1.4	750	F17723272000
	0.033	15	5.0 x 11.0 x 17.5	1.4	750	F17723332000
	0.039	15	6.0 x 12.0 x 17.5	2.0	500	F17723392000
	0.047	15	6.0 x 12.0 x 17.5	2.0	500	F17723472000
	0.056	15	6.0 x 12.0 x 17.5	2.0	500	F17723562000
	d_t = 0.80 mm ± 0.08 mm; C-TOL. = ± 10 %					
	0.068	15	7.0 x 13.5 x 17.5	2.4	450	F17723682000
	0.082	15	8.5 x 15.0 x 17.5	2.7	300	F17723822000
	0.10	15	8.5 x 15.0 x 17.5	2.7	325	F17724102000
	0.12	15	8.5 x 15.0 x 17.5	2.7	300	F17724122000
	0.15	15	8.5 x 15.0 x 17.5	2.7	300	F17724152160
	0.15	22.5	7.0 x 16.5 x 26.0	4.1	235	F17724152000
	0.18	22.5	7.0 x 16.5 x 26.0	4.1	235	F17724182000
	0.22	15	10.0 x 16.5 x 17.5	3.0	235	F17724222160
	0.22	22.5	8.5 x 16.5 x 26.5	4.6	200	F17724222000
	0.27	22.5	10.0 x 19.5 x 26.0	6.7	170	F17724272000
	0.33	15	13.5 x 22.5 x 18.0	5.5	185	F17724332160
	0.33	22.5	10.0 x 19.5 x 26.0	6.7	170	F17724332000
	0.39	27.5	11.0 x 21.0 x 31.0	9.1	125	F17724392000
	0.47	22.5	12.0 x 22.0 x 26.0	13.0	110	F17724472160
	0.47	27.5	11.0 x 21.0 x 31.0	9.1	125	F17724472000
	0.56	27.5	11.0 x 21.0 x 31.0	9.1	125	F17724562000
	0.68	22.5	15.5 x 26.5 x 26.5	13.5	110	F17724682160
	0.68	27.5	13.0 x 23.0 x 31.0	12.9	110	F17724682000
	0.82	27.5	13.0 x 23.0 x 31.0	12.9	110	F17724822000
	1.0	22.5	15.5 x 26.5 x 26.5	13.5	110	F17725102160
	1.0	27.5	15.0 x 25.0 x 31.5	15.0	100	F17725102000
	1.2	37.5	14.5 x 24.5 x 41.5	18.9	80	F17725122000
	1.5	27.5	18.0 x 28.0 x 31.0	19.0	85	F17725152160
	1.5	37.5	15.5 x 28.5 x 41.5	24.0	70	F17725152000
	1.8	37.5	15.5 x 28.5 x 41.5	24.0	70	F17725182000
	2.2	27.5	21.0 x 31.0 x 31.0	28.0	70	F17725222160
	2.2	37.5	18.0 x 32.5 x 41.5	31.6	60	F17725222000
	d_t = 0.60 mm ± 0.06 mm; C-TOL. = ± 20 %					
	0.010	15	5.0 x 11.0 x 17.5	1.4	750	F17723102200
	0.015	15	5.0 x 11.0 x 17.5	1.4	750	F17723152200
	0.022	15	5.0 x 11.0 x 17.5	1.4	750	F17723222200
	0.033	15	5.0 x 11.0 x 17.5	1.4	750	F17723332200
	0.047	15	5.0 x 11.0 x 17.5	1.4	750	F17723472200
0.068	15	6.0 x 12.0 x 17.5	2.0	600	F17723682200	
0.10	15	6.0 x 12.0 x 17.5	2.0	600	F17724102200	

ELECTRICAL DATA AND ORDERING INFORMATION						
U_{RAC} (V)	CAP. (μF)	PITCH (mm)	DIMENSIONS ⁽⁴⁾ w x h x l MAX. (mm)	MASS ⁽³⁾ (g)	SPQ (pieces) SHORT LEAD	ORDERING CODE BULK LEAD LENGTH 6 mm - 1 mm ⁽¹⁾⁽²⁾
d_t = 0.80 mm ± 0.08 mm; C-TOL. = ± 20 %						
310	0.15	15	8.5 x 15.0 x 17.5	2.7	325	F17724152260
	0.15	22.5	6.0 x 15.5 x 26.0	3.3	260	F17724152200
	0.22	15	10.0 x 16.5 x 17.5	4.5	300	F17724222260
	0.22	22.5	7.0 x 16.5 x 26.0	4.1	235	F17724222200
	0.33	15	13.5 x 22.5 x 18.0	5.5	185	F17724332260
	0.33	22.5	8.5 x 18.0 x 26.0	5.3	190	F17724332200
	0.47	22.5	10.0 x 19.5 x 26.0	6.7	170	F17724472260
	0.47	27.5	9.0 x 19.0 x 31.5	6.8	160	F17724472200
	0.68	22.5	12.0 x 22.0 x 26.0	13.4	110	F17724682260
	0.68	27.5	11.0 x 21.0 x 31.0	12.9	125	F17724682200
	1.0	22.5	15.5 x 26.5 x 26.5	13.5	110	F17725102260
	1.0	27.5	15.0 x 25.0 x 31.5	15.0	100	F17725102200
	1.5	27.5	18.0 x 28.0 x 31.5	19.0	85	F17725152260
	1.5	37.5	14.5 x 24.5 x 41.5	18.9	80	F17725152200
	2.2	27.5	21.0 x 31.0 x 31.0	28.0	70	F17725222260
2.2	37.5	15.5 x 28.5 x 41.5	24.0	70	F17725222200	

Notes

- SPQ = Standard Packing Quantity
- For detailed tape specifications refer to packaging information: www.vishay.com/doc?28139
- (1) For further packaging see table “Composition of Catalog Number”
- (2) Further information about packaging quantities with different lead length and / or taped versions, see document “Packing Quantities” www.vishay.com/doc?27608
- (3) Weight for short lead product only
- (4) For tolerances see chapter “Space Requirements for Printed-Circuit Board Applications and Dimension Tolerances”

APPROVALS				
SAFETY APPROVALS X2	VOLTAGE	VALUE	FILE NUMBERS	LINK
EN 60384-14 (ENEC) (= IEC 60384-14 ed-4)	310 V _{AC}	0.01 μF to 2.2 μF X2	40005079	www.vishay.com/doc?28196
UL 60384-14	310 V _{AC}	0.01 μF to 2.2 μF X2	E354331	www.vishay.com/doc?28191
CSA-E 384-14	310 V _{AC}	0.01 μF to 2.2 μF X2	E354331	
CB test-certificate	310 V _{AC}	0.01 μF to 2.2 μF X2	DE1-58410	www.vishay.com/doc?28226
The ENEC-approval together with the CB-certificate replace all national marks of the following countries (they have already signed the ENEC-agreement): Austria; Belgium; Czech. Republic; Denmark; Finland; France; Germany; Greece; Hungary; Ireland; Italy; Luxembourg; Netherlands; Norway; Portugal; Slovenian; Spain; Sweden; Switzerland and United Kingdom.				

MOUNTING

Normal Use

The capacitors are designed for mounting on printed-circuit boards. The capacitors packed in bandoliers are designed for mounting in printed-circuit boards by means of automatic insertion machines.

For detailed tape specifications refer to packaging information: www.vishay.com/doc?28139.

Specific Method of Mounting to Withstand Vibration and Shock

In order to withstand vibration and shock tests, it must be ensured that stand-off pips are in good contact with the printed-circuit board:

- For pitches ≤ 15 mm capacitors shall be mechanically fixed by the leads
- For larger pitches the capacitors shall be mounted in the same way and the body clamped

SPACE REQUIREMENTS FOR PRINTED-CIRCUIT BOARD APPLICATIONS AND DIMENSION TOLERANCES

For the maximum product dimensions and maximum space requirements for length ($l_{max.}$), width ($w_{max.}$) and height ($h_{max.}$) following tolerances must be taken in account in the envelopment of the components as shown in the drawings below.

- For products with pitch ≤ 15 mm, $\Delta w = \Delta l = 0.3$ mm, and $\Delta h = 0.1$ mm
- For products with 15 mm $<$ pitch ≤ 27.5 mm, $\Delta w = \Delta l = 0.5$ mm, and $\Delta h = 0.1$ mm
- For products with pitch = 37.5 mm, $\Delta w = \Delta l = 0.7$ mm, and $\Delta h = 0.5$ mm

Eccentricity defined as in drawing. The maximum eccentricity is smaller than or equal to the lead diameter of the product concerned.

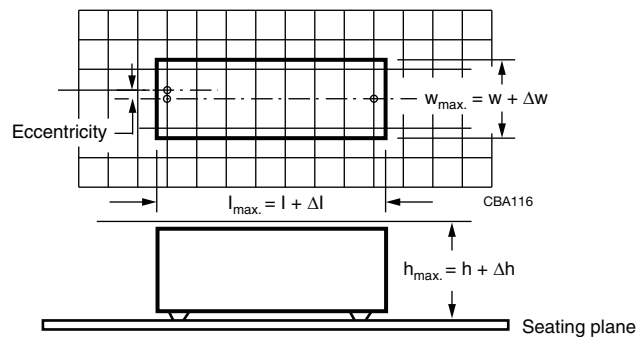

For the minimum product dimensions for length ($l_{min.}$), width ($w_{min.}$) and height ($h_{min.}$) following tolerances of the components are valid:

$l_{min.} = l - \Delta l$, $w_{min.} = w - \Delta w$, and $h_{min.} = h - \Delta h$ following

- For products with pitch ≤ 10 mm, $\Delta l = 0.3$ mm, and $\Delta w = \Delta h = 0.3$ mm
- For products with pitch = 15 mm, $\Delta l = 0.5$ mm, and $\Delta w = \Delta h = 0.5$ mm
- For products with 15 mm $<$ pitch ≤ 27.5 mm, $\Delta l = 1.0$ mm and $\Delta w = \Delta h = 0.5$ mm
- For products with pitch = 37.5 mm, $\Delta l = 1.0$ mm and $\Delta w = \Delta h = 1.0$ mm

SOLDERING CONDITIONS

For general soldering conditions and wave soldering profile, we refer to the application note: "Soldering Guidelines for Film Capacitors": www.vishay.com/doc?28171

Storage Temperature

$T_{stg} = -25$ °C to $+35$ °C with RH maximum 75 % without condensation

Ratings and Characteristics Reference Conditions

Unless otherwise specified, all electrical values apply to an ambient temperature of 23 °C ± 1 °C, an atmospheric pressure of 86 kPa to 106 kPa and a relative humidity of 50 % ± 2 %.

For reference testing, a conditioning period shall be applied over 96 h ± 4 h by heating the products in a circulating air oven at the rated temperature and a relative humidity not exceeding 20 %.



CHARACTERISTICS

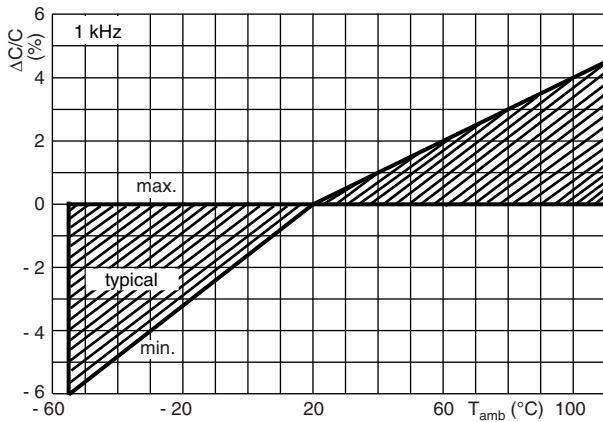

Capacitance as a function of ambient temperature (typical curve)

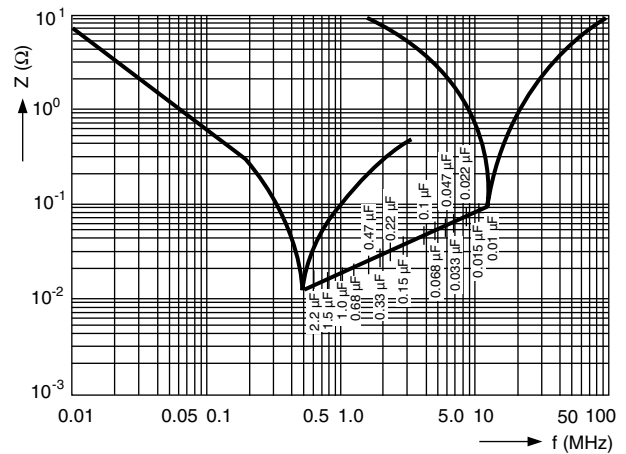

Impedance as a function of frequency (typical curve)

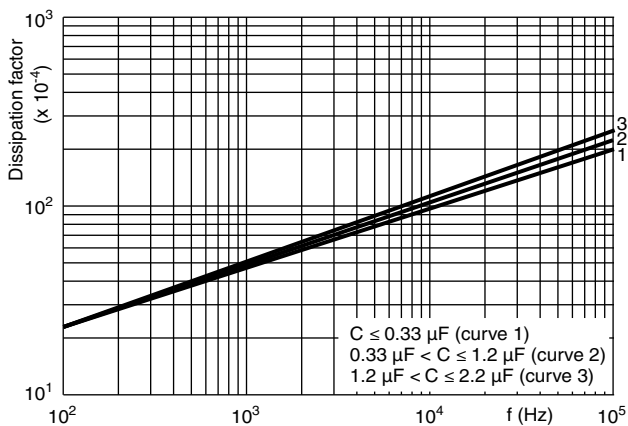

Tangent of loss angle as a function of frequency (typical curve)

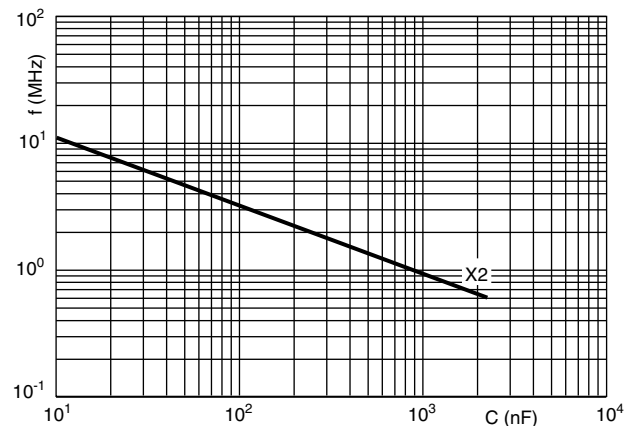

Resonant frequency as a function of capacitance (typical curve)

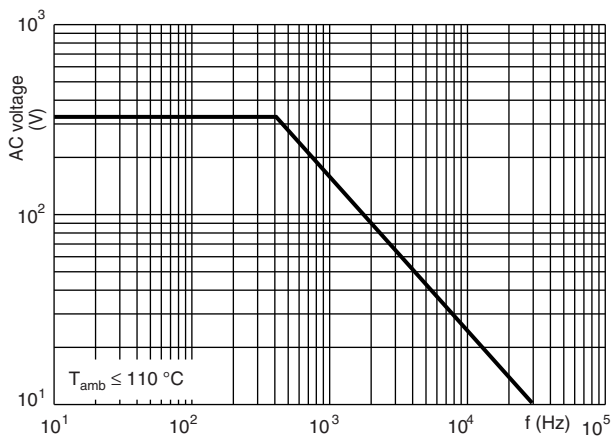

Max. RMS voltage as a function of frequency

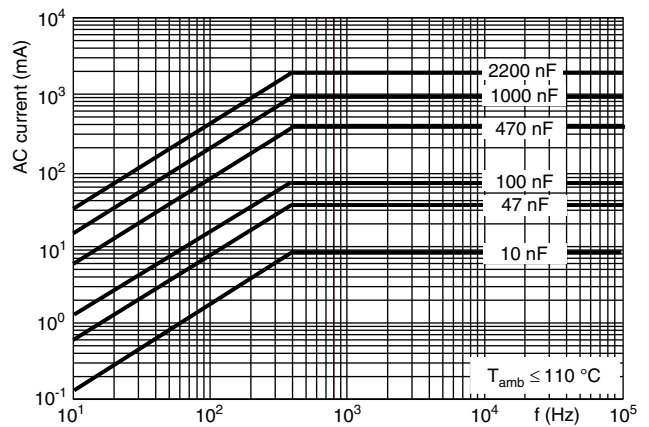

Max. RMS current as a function of frequency

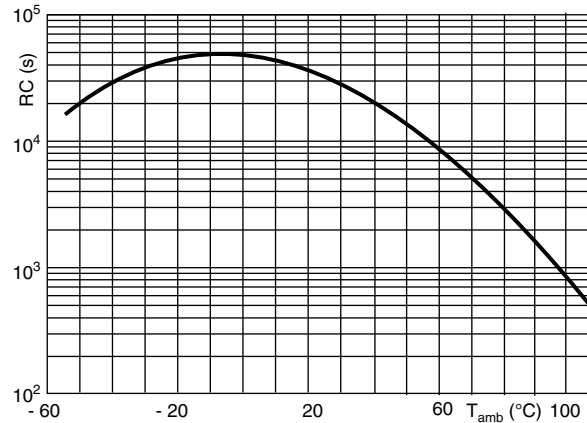

Insulation resistance as a function of ambient temperature (typical curve)

APPLICATION NOTES AND LIMITING CONDITIONS

- For X2 electromagnetic interference suppression where a higher stability grade is needed for **continuous across the line applications** (50 Hz/60 Hz) with a maximum mains voltage of 310 V_{AC}.
- These capacitors are not intended for continuous pulse application. For these situations capacitors of the AC and pulse programs must be used.
- For series impedance applications we refer to application note: www.vishay.com/doc?28153
- The maximum ambient temperature must not exceed 110 °C.
- Rated voltage pulse slope:
if the pulse voltage is lower than the rated voltage, the values of the specific reference data can be multiplied by 435 V_{DC} and divided by the applied voltage.

INSPECTION REQUIREMENTS

General Notes

Sub-clause numbers of tests and performance requirements refer to the “Sectional Specification, Publication IEC 60384-14 ed 3 and Specific Reference Data”.

GROUP C INSPECTION REQUIREMENTS		
SUB-CLAUSE NUMBER AND TEST	CONDITIONS	PERFORMANCE REQUIREMENTS
SUB-GROUP C1A PART OF SAMPLE OF SUB-GROUP C1		
4.1 Dimensions (detail)		As specified in chapter “General Data” of this specification
Initial measurements	Capacitance Tangent of loss angle: for C ≤ 1 μF at 10 kHz for C > 1 μF at 1 kHz	
4.3 Robustness of terminations	Tensile: load 10 N; 10 s Bending: load 5 N; 4 x 90°	No visible damage
4.4 Resistance to soldering heat	No pre-drying Method: 1A Solder bath: 280 °C ± 5 °C Duration: 10 s	



GROUP C INSPECTION REQUIREMENTS		
SUB-CLAUSE NUMBER AND TEST	CONDITIONS	PERFORMANCE REQUIREMENTS
SUB-GROUP C1A PART OF SAMPLE OF SUB-GROUP C1		
4.19 Component solvent resistance	Isopropylalcohol at room temperature Method: 2 Immersion time: 5 min ± 0.5 min Recovery time: min. 1 h, max. 2 h	
4.4.2 Final measurements	Visual examination Capacitance Tangent of loss angle Insulation resistance	No visible damage Legible marking $ \Delta C/C \leq 5\%$ of the value measured initially Increase of $\tan \delta$ ≤ 0.008 for: $C \leq 1 \mu F$ or ≤ 0.005 for: $C > 1 \mu F$ Compared to values measured initially As specified in section "Insulation Resistance" of this specification
SUB-GROUP C1B PART OF SAMPLE OF SUB-GROUP C1		
Initial measurements	Capacitance Tangent of loss angle: for $C \leq 1 \mu F$ at 10 kHz for $C > 1 \mu F$ at 1 kHz	
4.20 Solvent resistance of the marking	Isopropylalcohol at room temperature Method: 1 Rubbing material: cotton wool Immersion time: 5 min ± 0.5 min	No visible damage Legible marking
4.6 Rapid change of temperature	$\theta A = -40\text{ }^\circ C$ $\theta B = +110\text{ }^\circ C$ 5 cycles Duration $t = 30$ min	
4.6.1 Inspection	Visual examination	No visible damage
4.7 Vibration	Mounting: see section "Mounting" of this specification Procedure B4 Frequency range: 10 Hz to 55 Hz Amplitude: 0.75 mm or Acceleration 98 m/s^2 (whichever is less severe) Total duration 6 h	
4.7.2 Final inspection	Visual examination	No visible damage
4.9 Shock	Mounting: See section "Mounting" for more information Pulse shape: half sine Acceleration: 490 m/s^2 Duration of pulse: 11 ms	
4.9.2 Final measurements	Visual examination Capacitance Tangent of loss angle Insulation resistance	No visible damage $ \Delta C/C \leq 5\%$ of the value measured initially Increase of $\tan \delta$ ≤ 0.008 for: $C \leq 1 \mu F$ or ≤ 0.005 for: $C > 1 \mu F$ Compared to values measured initially As specified in section "Specific Reference" of this specification



GROUP C INSPECTION REQUIREMENTS		
SUB-CLAUSE NUMBER AND TEST	CONDITIONS	PERFORMANCE REQUIREMENTS
SUB-GROUP C1 COMBINED SAMPLE OF SPECIMENS OF SUB-GROUPS C1A AND C1B		
4.11 Climatic sequence	Capacitance	
4.11.1 Initial measurements	Measured in 4.4.2 and 4.9.2 Tangent of loss angle Measured initially in C1A and C1B	
4.11.2 Dry heat	Temperature: 110 °C Duration: 16 h	
4.11.3 Damp heat cyclic Test Db, first cycle		
4.11.4 Cold	Temperature: -40 °C Duration: 2 h	
4.11.5 Damp heat cyclic Test Db, remaining cycles		
4.11.6 Final measurements	Visual examination	No visible damage Legible marking
	Capacitance	$ \Delta C/C \leq 5\%$ of the value measured in 4.11.1
	Tangent of loss angle	Increase of $\tan \delta$ ≤ 0.008 for: $C \leq 1 \mu\text{F}$ or ≤ 0.005 for: $C > 1 \mu\text{F}$ Compared to values measured in 4.11.1
	Voltage proof 1350 V _{DC} 1 min between terminations	No permanent breakdown or flash-over
	Insulation resistance	$\geq 50\%$ of values specified in section "Insulation Resistance" of this specification
SUB-GROUP C2		
4.12 Damp heat steady state	56 days, 40 °C, 90 % to 95 % RH No load	
4.12.1 Initial measurements	Capacitance Tangent of loss angle: 1 kHz	
4.12.3 Final measurements	Visual examination	No visible damage Legible marking
	Capacitance	$ \Delta C/C \leq 5\%$ of the value measured in 4.12.1
	Tangent of loss angle	Increase of $\tan \delta$ ≤ 0.008 for: $C \leq 1 \mu\text{F}$ or ≤ 0.005 for: $C > 1 \mu\text{F}$ Compared to values measured in 4.12.1
	Voltage proof 1350 V _{DC} ; 1 min between terminations	No permanent breakdown or flash-over
	Insulation resistance	$\geq 50\%$ of values specified in section "Insulation Resistance" of this specification

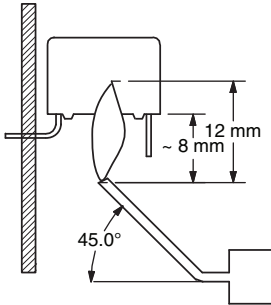

GROUP C INSPECTION REQUIREMENTS		
SUB-CLAUSE NUMBER AND TEST	CONDITIONS	PERFORMANCE REQUIREMENTS
SUB-GROUP C3		
4.13.1 Initial measurements	Capacitance Tangent of loss angle: for C ≤ 1 μF at 10 kHz for C > 1 μF at 1 kHz	
4.13 Impulse voltage	3 successive impulses, full wave, peak voltage: X2: 2.5 kV for C ≤ 1 μF X2: 2.5 kV/√C for C > 1 μF Max. 24 pulses	No self healing breakdowns or flash-over
4.14 Endurance	Duration: 1000 h 1.25 x U _{RAC} at 110 °C Once in every hour the voltage is increased to 1000 V (RMS) for 0.1 s via resistor of 47 Ω ± 5 %	
4.14.7 Final measurements	Visual examination Capacitance Tangent of loss angle Voltage proof 1350 V _{DC} ; 1 min between terminations 2120 V _{AC} ; 1 min between terminations and case Insulation resistance	No visible damage Legible marking ΔC/C ≤ 5 % compared to values measured in 4.13.1 Increase of tan δ ≤ 0.008 for: C ≤ 1 μF or ≤ 0.005 for: C > 1 μF Compared to values measured in 4.13.1 No permanent breakdown or flash-over ≥ 50 % of values specified in section "Insulation Resistance" of this specification
SUB-GROUP C4		
4.15 Charge and discharge	10 000 cycles Charged to 435 V _{DC} Discharge resistance: $R = \frac{435 V_{DC}}{1.5 \times C(dU/dt)}$	
4.15.1 Initial measurements	Capacitance Tangent of loss angle: for C ≤ 1 μF at 10 kHz for C > 1 μF at 1 kHz	
4.13.3 Final measurements	Capacitance Tangent of loss angle Insulation resistance	ΔC/C ≤ 10 % compared to values measured in 4.15.1 Increase of tan δ ≤ 0.008 for: C ≤ 1 μF or ≤ 0.005 for: C > 1 μF Compared to values measured in 4.15.1 ≥ 50 % of values specified in section "Insulation Resistance" of this specification

GROUP C INSPECTION REQUIREMENTS		
SUB-CLAUSE NUMBER AND TEST	CONDITIONS	PERFORMANCE REQUIREMENTS
SUB-GROUP C5		
4.16 Radio frequency characteristic	Resonance frequency	≥ 0.9 times the value as specified in section "Resonant Frequency" of this specification.
SUB-GROUP C6		
4.17 Passive flammability Class C	Bore of gas jet: Ø 0.5 mm Fuel: butane Test duration for actual volume V in mm ³ : V ≤ 250: 5 s 250 < V ≤ 500: 10 s 500 < V ≤ 1750: 20 s V > 1750: 30 s One flame application 	After removing test flame from capacitor, the capacitor must not continue to burn for more than 30 s. No burning particle must drop from the sample.
SUB-GROUP C7		
4.18 Active flammability	20 cycles of 2.5 kV discharges on the test capacitor connected to U _{RAC} .	The cheese cloth around the capacitors shall not burn with a flame. No electrical measurements are required.



Disclaimer

ALL PRODUCT, PRODUCT SPECIFICATIONS AND DATA ARE SUBJECT TO CHANGE WITHOUT NOTICE TO IMPROVE RELIABILITY, FUNCTION OR DESIGN OR OTHERWISE.

Vishay Intertechnology, Inc., its affiliates, agents, and employees, and all persons acting on its or their behalf (collectively, "Vishay"), disclaim any and all liability for any errors, inaccuracies or incompleteness contained in any datasheet or in any other disclosure relating to any product.

Vishay makes no warranty, representation or guarantee regarding the suitability of the products for any particular purpose or the continuing production of any product. To the maximum extent permitted by applicable law, Vishay disclaims (i) any and all liability arising out of the application or use of any product, (ii) any and all liability, including without limitation special, consequential or incidental damages, and (iii) any and all implied warranties, including warranties of fitness for particular purpose, non-infringement and merchantability.

Statements regarding the suitability of products for certain types of applications are based on Vishay's knowledge of typical requirements that are often placed on Vishay products in generic applications. Such statements are not binding statements about the suitability of products for a particular application. It is the customer's responsibility to validate that a particular product with the properties described in the product specification is suitable for use in a particular application. Parameters provided in datasheets and / or specifications may vary in different applications and performance may vary over time. All operating parameters, including typical parameters, must be validated for each customer application by the customer's technical experts. Product specifications do not expand or otherwise modify Vishay's terms and conditions of purchase, including but not limited to the warranty expressed therein.

Hyperlinks included in this datasheet may direct users to third-party websites. These links are provided as a convenience and for informational purposes only. Inclusion of these hyperlinks does not constitute an endorsement or an approval by Vishay of any of the products, services or opinions of the corporation, organization or individual associated with the third-party website. Vishay disclaims any and all liability and bears no responsibility for the accuracy, legality or content of the third-party website or for that of subsequent links.

Except as expressly indicated in writing, Vishay products are not designed for use in medical, life-saving, or life-sustaining applications or for any other application in which the failure of the Vishay product could result in personal injury or death. Customers using or selling Vishay products not expressly indicated for use in such applications do so at their own risk. Please contact authorized Vishay personnel to obtain written terms and conditions regarding products designed for such applications.

No license, express or implied, by estoppel or otherwise, to any intellectual property rights is granted by this document or by any conduct of Vishay. Product names and markings noted herein may be trademarks of their respective owners.