



Is Now Part of



ON Semiconductor®

To learn more about ON Semiconductor, please visit our website at
www.onsemi.com

Please note: As part of the Fairchild Semiconductor integration, some of the Fairchild orderable part numbers will need to change in order to meet ON Semiconductor's system requirements. Since the ON Semiconductor product management systems do not have the ability to manage part nomenclature that utilizes an underscore (_), the underscore (_) in the Fairchild part numbers will be changed to a dash (-). This document may contain device numbers with an underscore (_). Please check the ON Semiconductor website to verify the updated device numbers. The most current and up-to-date ordering information can be found at www.onsemi.com. Please email any questions regarding the system integration to Fairchild_questions@onsemi.com.

ON Semiconductor and the ON Semiconductor logo are trademarks of Semiconductor Components Industries, LLC dba ON Semiconductor or its subsidiaries in the United States and/or other countries. ON Semiconductor owns the rights to a number of patents, trademarks, copyrights, trade secrets, and other intellectual property. A listing of ON Semiconductor's product/patent coverage may be accessed at www.onsemi.com/site/pdf/Patent-Marking.pdf. ON Semiconductor reserves the right to make changes without further notice to any products herein. ON Semiconductor makes no warranty, representation or guarantee regarding the suitability of its products for any particular purpose, nor does ON Semiconductor assume any liability arising out of the application or use of any product or circuit, and specifically disclaims any and all liability, including without limitation special, consequential or incidental damages. Buyer is responsible for its products and applications using ON Semiconductor products, including compliance with all laws, regulations and safety requirements or standards, regardless of any support or applications information provided by ON Semiconductor. "Typical" parameters which may be provided in ON Semiconductor data sheets and/or specifications can and do vary in different applications and actual performance may vary over time. All operating parameters, including "Typicals" must be validated for each customer application by customer's technical experts. ON Semiconductor does not convey any license under its patent rights nor the rights of others. ON Semiconductor products are not designed, intended, or authorized for use as a critical component in life support systems or any FDA Class 3 medical devices or medical devices with a same or similar classification in a foreign jurisdiction or any devices intended for implantation in the human body. Should Buyer purchase or use ON Semiconductor products for any such unintended or unauthorized application, Buyer shall indemnify and hold ON Semiconductor and its officers, employees, subsidiaries, affiliates, and distributors harmless against all claims, costs, damages, and expenses, and reasonable attorney fees arising out of, directly or indirectly, any claim of personal injury or death associated with such unintended or unauthorized use, even if such claim alleges that ON Semiconductor was negligent regarding the design or manufacture of the part. ON Semiconductor is an Equal Opportunity/Affirmative Action Employer. This literature is subject to all applicable copyright laws and is not for resale in any manner.

FAN2560

350mA Low- V_{IN} LDO with Fast Transient Response

Features

- 55 μ A Typical Quiescent Current
- Up to 350mA Output Current
- 2.9V to 5.5V Bias Supply Voltage
- $V_{OUT}+0.1V$ to 5.5V Power Input Supply Voltage
- Fixed Voltage Options: 1.3V and 1.5V
- Thermal Shutdown Protection (TSD)
- Input Under-Voltage Lockout (UVLO)
- Short-Circuit Current Protection (SCP)
- 5-bump 0.96 x 1.33mm WLCSP

Applications

- Moderate Current Digital Loads
- DVB-H, DMB Processors
- Handsets, Smart Phones
- WLAN DC-DC Converter Modules
- PDA, DSC, PMP, and MP3 Players
- Portable Hard Disk Drives

Description

The FAN2560 is a linear low-dropout (LDO) regulator with a split-supply architecture. Separate bias and supply inputs allow bias to be taken directly from the battery, while the input is taken from a lower pre-regulated source. This allows a smaller differential voltage between input and output, which provides greater efficiency over a wider V_{BAT} range.

The FAN2560 is available in a fixed-voltage output, 5-bump, WLCSP package.

Typical Applications

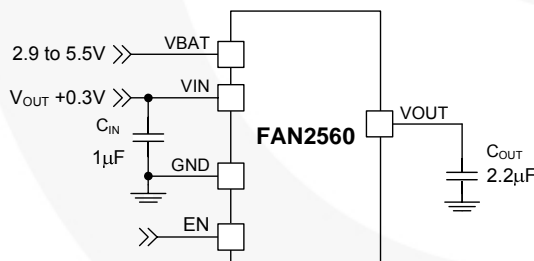

Figure 1. Separate Supply and Bias Line

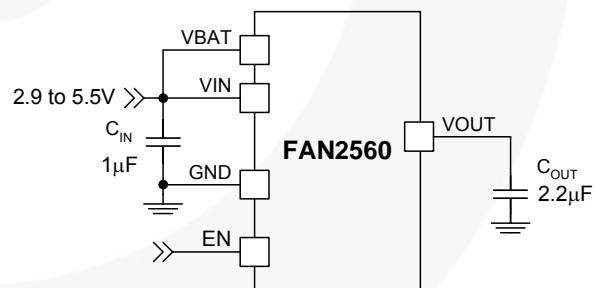

Figure 2. Connected Supply and Bias Line

Ordering Information

Part Number	Operating Temperature Range	Package	Eco Status	Packing Method
FAN2560UC13X	-40°C to 85°C	WLCSP-5 0.96 x 1.33mm	Green	Tape and Reel
FAN2560UC15X	-40°C to 85°C	WLCSP-5 0.96 x 1.33mm	Green	Tape and Reel

For Fairchild's definition of Eco Status, please visit: http://www.fairchildsemi.com/company/green/rohs_green.html.

Block Diagram

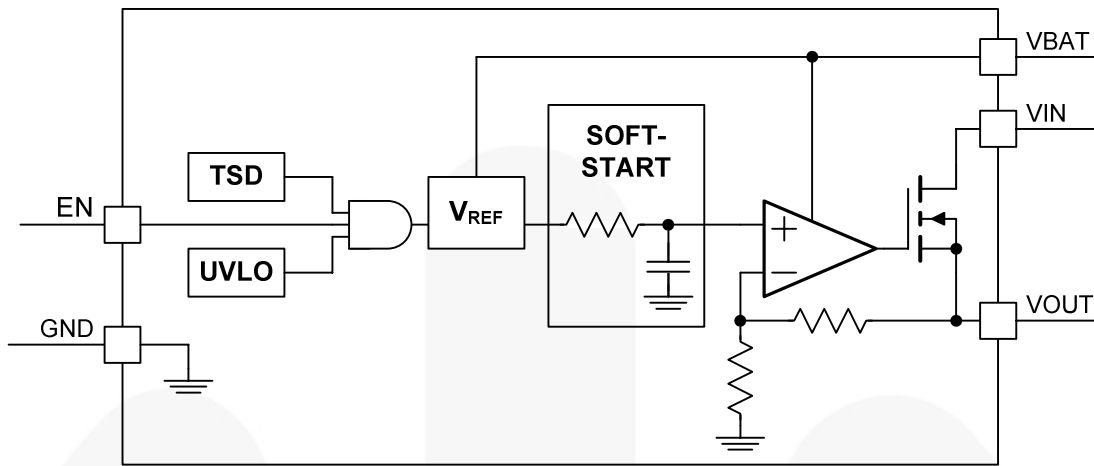

Figure 3. IC Block Diagram

Pin Configuration

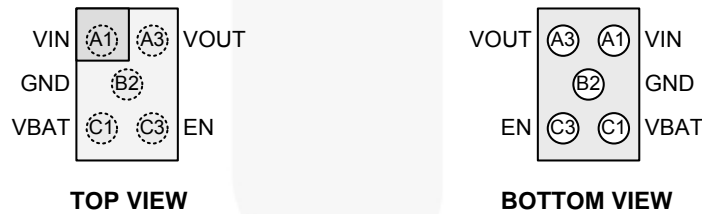

Figure 4. 0.96 x 1.33mm WLCSP package

Pin Definitions

Pin #	Name	Description
A1	VIN	Power supply input. A minimum 1 μ F MLCC is required to GND.
A3	VOUT	Output Voltage. A typical C_{OUT} =1 μ F to 2.2 μ F MLCC is required to GND, placed close to the V_{OUT} terminal.
C1	VBAT	Battery bias supply input. No capacitor is required unless another bulk capacitor is more than few inches away.
C3	EN	Enable input. The device is in shutdown mode when the voltage at this pin is <0.4V and enabled when >1.1V. The EN latches the LOW logic state once externally forced. Do not leave this pin floating when the device is turned ON.
B2	GND	Ground pin. Connect to a PCB GND plane.

Absolute Maximum Ratings

Stresses exceeding the absolute maximum ratings may damage the device. The device may not function or be operable above the recommended operating conditions and stressing the parts to these levels is not recommended. In addition, extended exposure to stresses above the recommended operating conditions may affect device reliability. The absolute maximum ratings are stress ratings only.

Symbol	Parameter	Min.	Max.	Units
	V_{BAT} , V_{IN} , EN	-0.3	6.0	V
V_{OUT}	Output Voltage	-0.3	$V_{IN} + 0.3V$	V
T_J	Junction Temperature	-40	+150	°C
T_{STG}	Storage Temperature	-65	+150	°C
T_L	Lead Soldering Temperature, 10 Seconds		+260	°C
ESD	Electrostatic Discharge Protection Level	Human Body Model per JESD22-A114	3.5	kV
		Charged Device Model per JESD22-C101	1.5	

Recommended Operating Conditions

The Recommended Operating Conditions table defines the conditions for actual device operation. Recommended operating conditions are specified to ensure optimal performance to the datasheet specifications. Fairchild does not recommend exceeding them or designing to absolute maximum ratings.

Symbol	Parameter	Min.	Typ.	Max.	Units
V_{BAT}	Bias Supply Range, $(V_{OUT} + 1.4V) < V_{BAT}$	2.9		5.5	V
V_{IN}	Power Supply Range, $(V_{IN} < V_{BAT})$	$V_{OUT} + V_{DO}$		V_{BAT}	V
I_{OUT}	Output Current	0		350	mA
C_{IN}	Input Capacitor (Effective Capacitance)	0.7	1.0		μF
	Equivalent Series Resistance (ESR)	0		300	m Ω
C_{OUT}	Output Capacitor (Effective Capacitance)	0.7	2.2	12.0	μF
	Equivalent Series Resistance (ESR)	3		300	m Ω
T_A	Operating Ambient Temperature Range	-40		+85	°C
T_J	Operating Junction Temperature Range	-40		+125	°C

Thermal Properties

Symbol	Parameter	Min.	Typ.	Max.	Units
Θ_{JA}	Junction-to-Ambient Thermal Resistance		180 ⁽¹⁾		°C/W

Note:

- Junction-to-ambient thermal resistance is a function of application and board layout. This data is measured with four-layer boards in accordance to JESD51- JEDEC standard. Special attention must be paid not to exceed junction temperature $T_{J(max)}$ at a given ambient temperature T_A .

Electrical Characteristics

$V_{BAT}=2.9V$ to $5.5V$, $V_{IN}=V_{OUT} + 0.3V$, $T_A=-40^{\circ}C$ to $+85^{\circ}C$, Test Circuit Figure 1, unless otherwise noted. Typical values are at $T_A=25^{\circ}C$, $V_{BAT}=3.6V$, $I_{LOAD}=1mA$, $V_{EN}=1.8V$.

Symbol	Parameter	Conditions	Min.	Typ.	Max.	Units	
Power Supplies							
V_{BAT}	Battery Input Supply	$(V_{OUT} + 1.4V) < V_{BAT}$	2.9		5.5	V	
V_{IN}	Input Voltage Range	$V_{IN} < V_{BAT}$	$V_{OUT} + V_{DO}$		V_{BAT}	V	
I_{BAT}	V_{BAT} Supply Current	$I_{LOAD}=0\mu A$		55	70	μA	
I_{IN}	V_{IN} Supply Current	$I_{LOAD}=0\mu A$		4	11	μA	
I_{VBATSD}	V_{BAT} Shutdown Supply Current	$V_{BAT}=3.6V$, EN=GND		0.01	1.00	μA	
$I_{VINS D}$	V_{IN} shutdown Supply Current	$V_{BAT}=3.6V$, EN=GND		0.01	1.00	μA	
V_{UVLO}	Under-voltage Lockout Threshold	V_{BAT} Falling Edge		2.0	2.4	V	
		Hysteresis		0.05		V	
$V_{(EN)}$	Enable High-level Input Voltage		1.1			V	
	Enable Low-level Input Voltage				0.4	V	
$I_{(EN)}$	Enable Input Leakage Current	EN= V_{IN} or GND		0	0.5	μA	
Regulation							
I_{OUT}	Maximum Output Current		350			mA	
V_{DO}	Dropout Voltage with Respect to $V_{IN}^{(2)}$	$I_{LOAD}=350mA$		70	200	mV	
ΔV_{OUT}	Output Voltage Accuracy	Over Full V_{IN} , I_{OUT} , and Temperature Range	-2		2	%	
$\Delta V_{OUTline}$	Line Regulation	Over Full V_{IN} , V_{BAT} , I_{OUT} Range		< 6		mV	
$\Delta V_{OUTload}$	Load Regulation						
I_{SCP}	Short-circuit Current Limit			400		mA	
I_{SU}	Start-up Peak Current	V_{BAT} and V_{IN} applied, EN from L to H, no load, $T_A=-30C$ to $+85C$	$3V < V_{BAT} < 4.5V$		130	300	mA
			$2.9V < V_{BAT} < 5.5V$			500	
TSD	Thermal Shutdown	Rising Temperature		150		$^{\circ}C$	
		Hysteresis		10		$^{\circ}C$	
PSRR	Power Supply Rejection Ratio	V_{IN} , 10Hz to 10kHz		> 60		dB	
		V_{BAT} , 10Hz to 10kHz		> 50			
e_n	Output Noise Voltage	10Hz to 100kHz		60		μV_{RMS}	
Timing Characteristics							
Peak $\Delta V_{OUTline}$	Line Transient Response	600mV, $t_{RISE}=t_{FALL}=10\mu s$		± 2		mV	
Peak $\Delta V_{OUTload}$	Load Transient Response	0 to 300mA, $t_{RISE}=t_{FALL}=1\mu s$		± 15		mV	
t_{ON}	Turn-on Time			70	200	μs	

Note:

- 2 Dropout voltage is the minimum input to output differential voltage needed to maintain V_{OUT} in regulation, in specified conditions

Typical Characteristics

Unless otherwise specified, $C_{IN}=1\mu F$ ceramic, $C_{OUT}=2.2\mu F$ ceramic, $V_{IN}=V_{OUTnom} + 0.3V$, $V_{BAT}=3.6V$, $T_A=25C$, $V_{EN}=1.8V$.

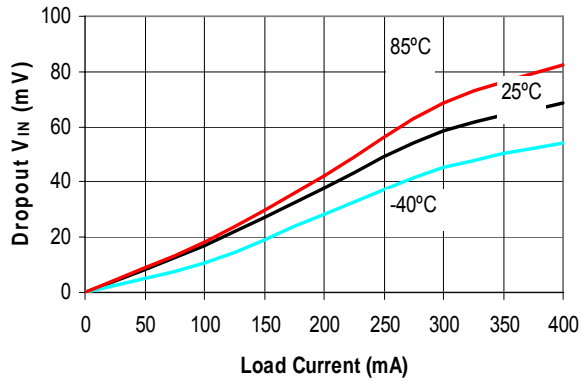

Figure 5. Dropout Voltage vs. Load Current

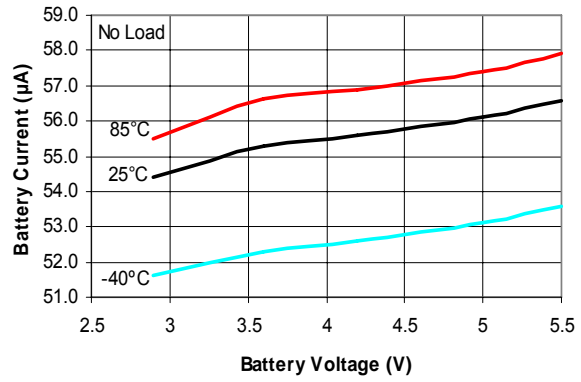

Figure 6. Battery Quiescent Supply Current

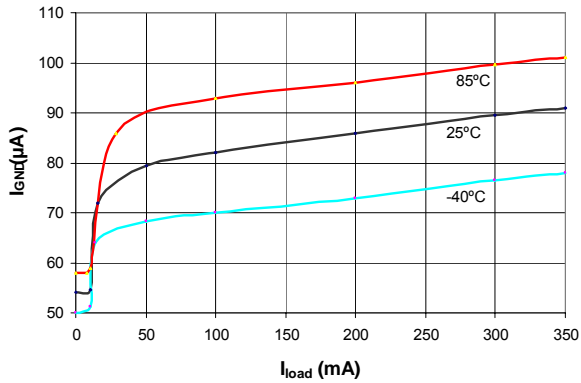

Figure 7. GND Current vs. Load Current

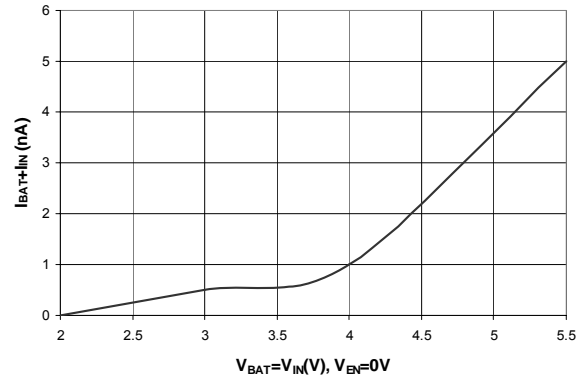

Figure 8. Off Mode Current

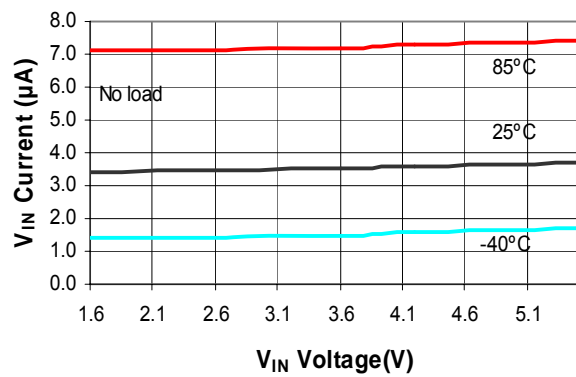

Figure 9. Input V_{IN} Quiescent Current ($V_{BAT}=5.5V$)

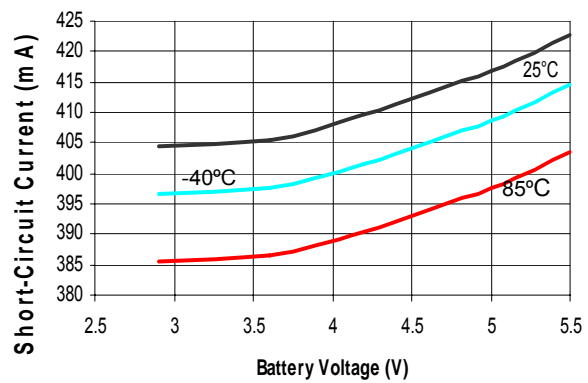

Figure 10. Output Short-Circuit Current

Typical Characteristics (Continued)

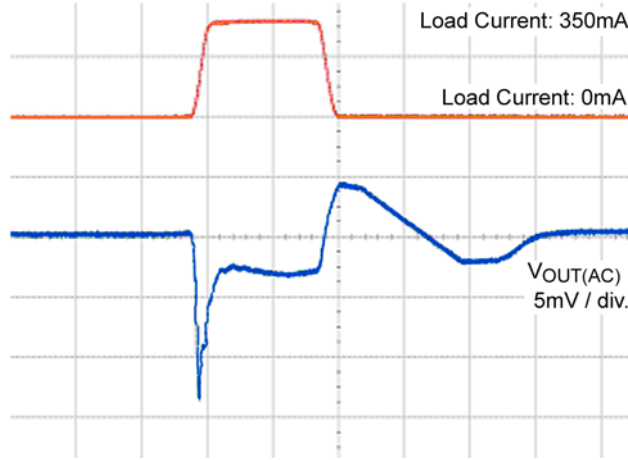

Figure 11. Load Transient Response (5µs/div.)

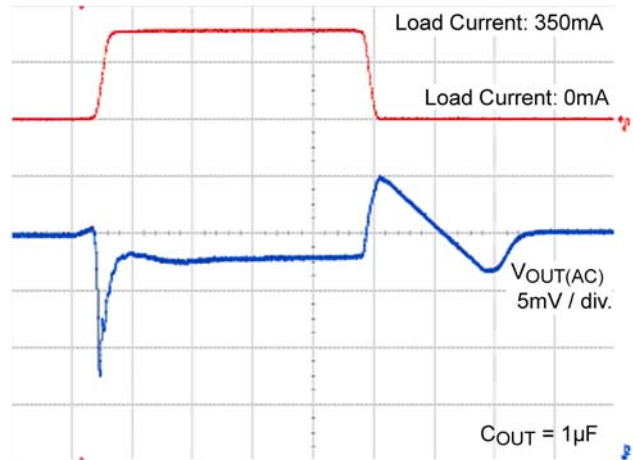

Figure 12. Load Transient Response (5µs/div.)

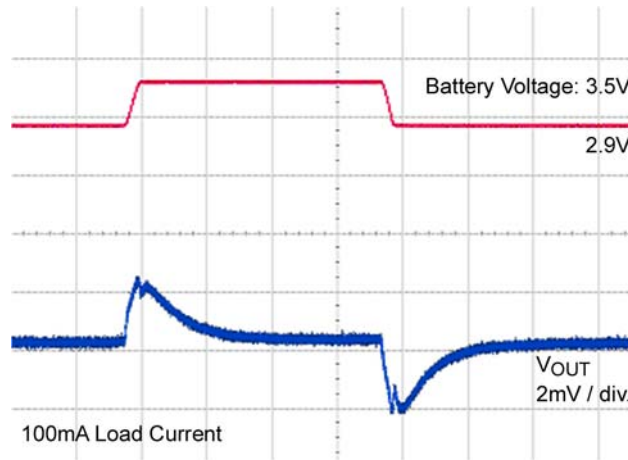

Figure 13. Line Transient Response (50µs/div.)

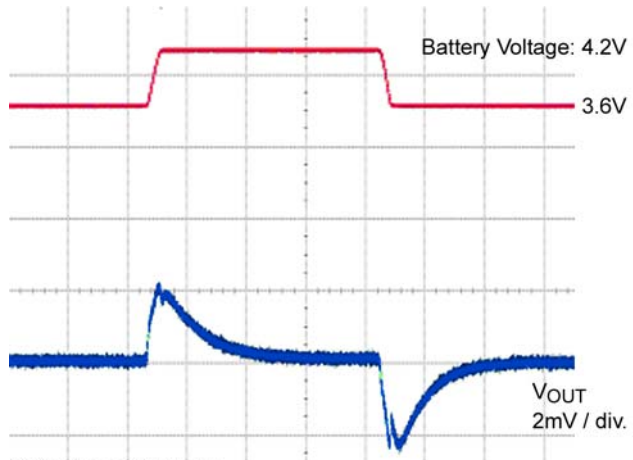

Figure 14. Line Transient Response (50µs/div.)

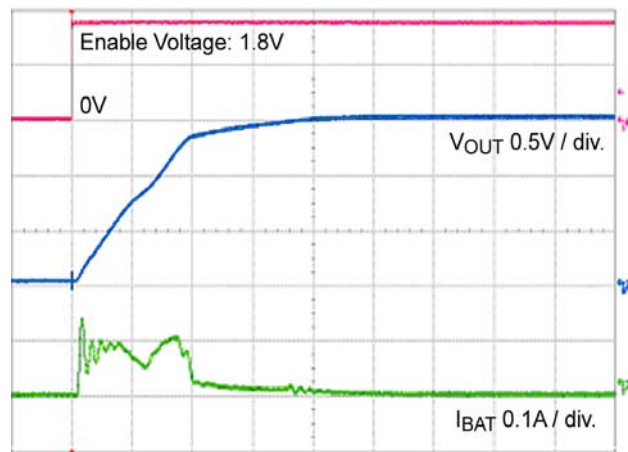

Figure 15. Start-up and Inrush Current (20µs/div.)

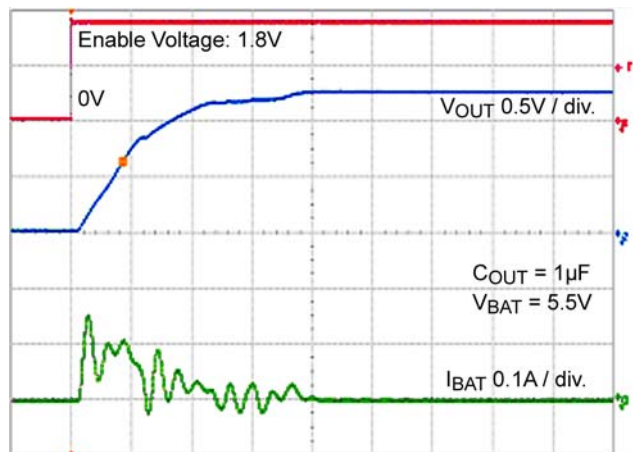

Figure 16. Start-up and Inrush Current (20µs/div.)

Typical Characteristics (Continued)

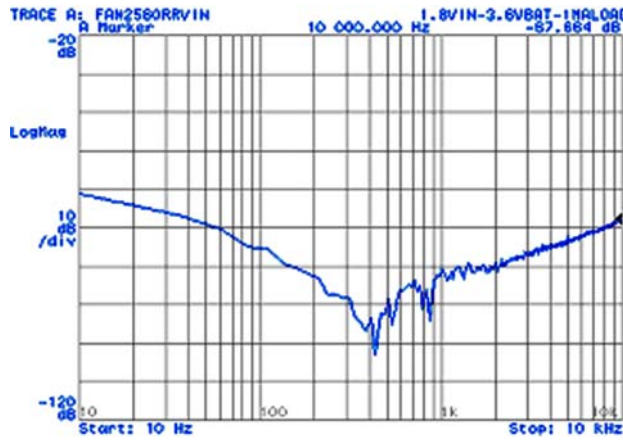

Figure 17. PSRR V_{IN} , 10Hz to 10kHz, 1mA

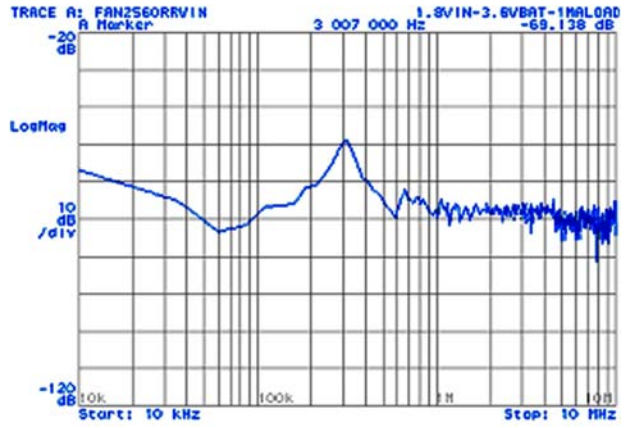

Figure 18. PSRR V_{IN} , 10kHz to 10MHz, 1mA

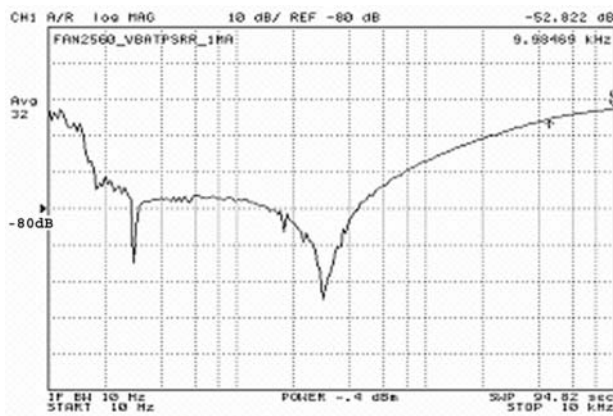

Figure 19. PSRR V_{BAT} , 10Hz to 10kHz, 1mA

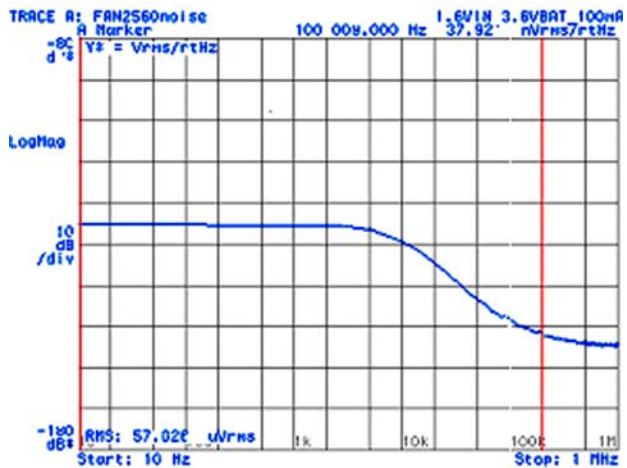

Figure 20. Noise Spectral Power Density, 100mA

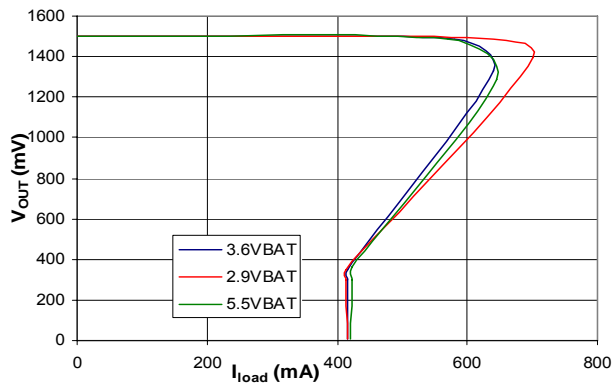

Figure 21. Output Current Voltage Characteristic, 1.5V Option

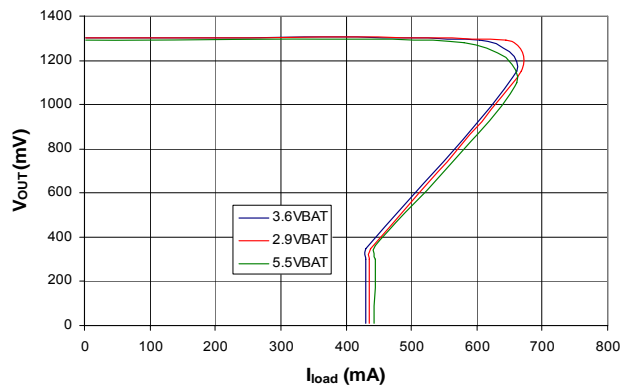

Figure 22. Output Current Voltage Characteristic, 1.3V Option

Application Information

ENABLE Latch

A pull-down resistor latches the LOW state of the EN input after this input is externally forced LOW. A low-side switch turns ON a 370 kΩ pull-down resistance to keep the EN in LOW state, even if the EN input is subsequently left floating.

Soft-Start

A soft-start function prevents an excessive input current flow during start-up. When the LDO is enabled, the soft-start circuit limits the peak inrush current below the specified maximum value, which increases when C_{OUT} increases. To further reduce the peak inrush current, the output capacitance may be lowered to 1μF, taking advantage of FAN2560 stability over a wide range of C_{OUT} capacitance.

Short-Circuit and Thermal Protection

The FAN2560 output current voltage characteristic has a fold-back shape that indicates a short-circuit current limit lower than the maximum load current. Although the short-circuit current is limited to below 500mA, the device can supply high peak output currents of up to 1A for brief periods. However, this output overload may cause the die temperature to increase and exceed maximum ratings due to power dissipation. In such cases, depending upon the ambient temperature, V_{IN}, load current, and the junction-to-air thermal resistance (θ_{JA}) of the die, the device may enter thermal shutdown. During output overload conditions, when the die temperature exceeds the shutdown limit temperature of 150°C, the onboard thermal protection disables the output until the temperature drops below this limit, at which point the output is re-enabled.

Thermal Considerations

For best performance, the die temperature and the power dissipated should be kept at moderate values. The maximum power dissipated can be evaluated based on the following relationship:

$$P_{D(max)} = \left\{ \frac{T_{J(max)} - T_A}{\theta_{JA}} \right\} \quad (1)$$

where T_{J(max)} is the maximum allowable junction temperature of the die, which is 125°C, and T_A is the ambient operating temperature. θ_{JA} is dependent on the surrounding PCB layout and can be improved by providing a heat sink of surrounding copper ground.

The addition of backside copper with through-holes, stiffeners, and other enhancements can also aid in reducing θ_{JA}. The heat contributed by the dissipation of other devices located nearby must be included in design considerations.

Reverse Current Path

During normal operation, V_{IN} is higher than V_{OUT} and the parasitic diode for the series power FET is reverse biased. If the output voltage is externally forced above the input voltage, the parasitic diode gets forward biased and starts to conduct. In this case, it is necessary to limit the reverse current to maximum 100mA to avoid adversely affecting reliability.

Capacitors Selection

The FAN2560 is stable with a wide range of ceramic output capacitors. An output capacitor of at least 0.7μF effective capacitance and the minimum ESR over the frequency range of 3 to 300mΩ is required to ensure stability over the full range of supply voltages and load currents. High-ESR tantalum or electrolytic capacitors may be used, but a low ESR ceramic capacitor has to be connected in parallel at the output, at a distance no more than 1-inch from the V_{OUT} pin. The MLCC capacitors indicated in Table 1 have been successfully tested with the FAN2560.

Table 1. Recommended Capacitors

Capacitance	Size	Vendor	Part number
1μF	0603	MURATA	GRM188R71C105KA120
2.2μF	0603	MURATA	GRM188R61A225KF340
2.2μF	0402	MURATA	GRM155R60J225ME15

Application Example: Post Regulator for a Switching Converter

The FAN2560 is an ideal choice for battery-powered equipment. The low quiescent bias current can be supplied directly from the battery, while the input voltage can come from a high-efficiency buck regulator, like FAN5350. This combination provides both best

efficiency and low noise output. As can be seen in the scope pictures below the schematic, the already-low output voltage ripple, inherent to a switching regulator, is significantly attenuated by the FAN2560 at any frequency within the switching operating range.

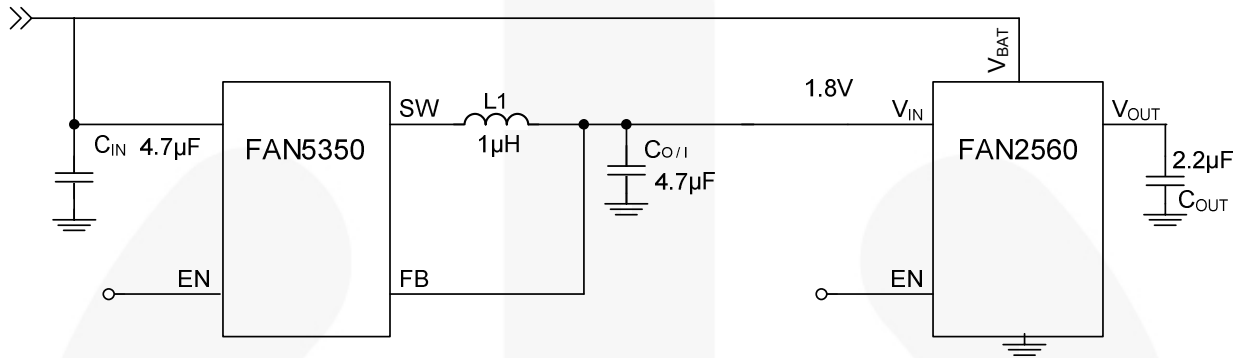

Figure 23. Post Regulator for a Switching Converter

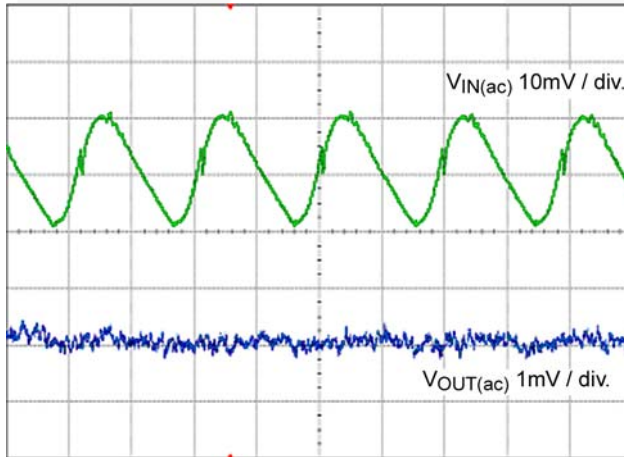

Figure 24. PFM Mode (100mA Load) Buck Ripple Rejection, Horizontal Scale: 500ns/div.

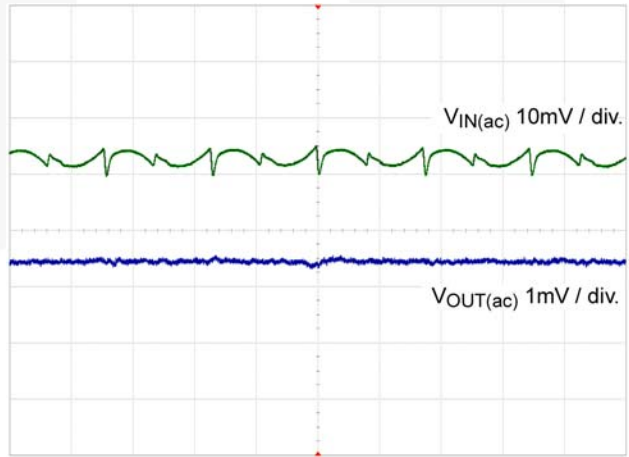

Figure 25. PWM, 3MHz (300mA Load) Buck Ripple Rejection, Horizontal Scale: 200ns/div.

Physical Dimensions

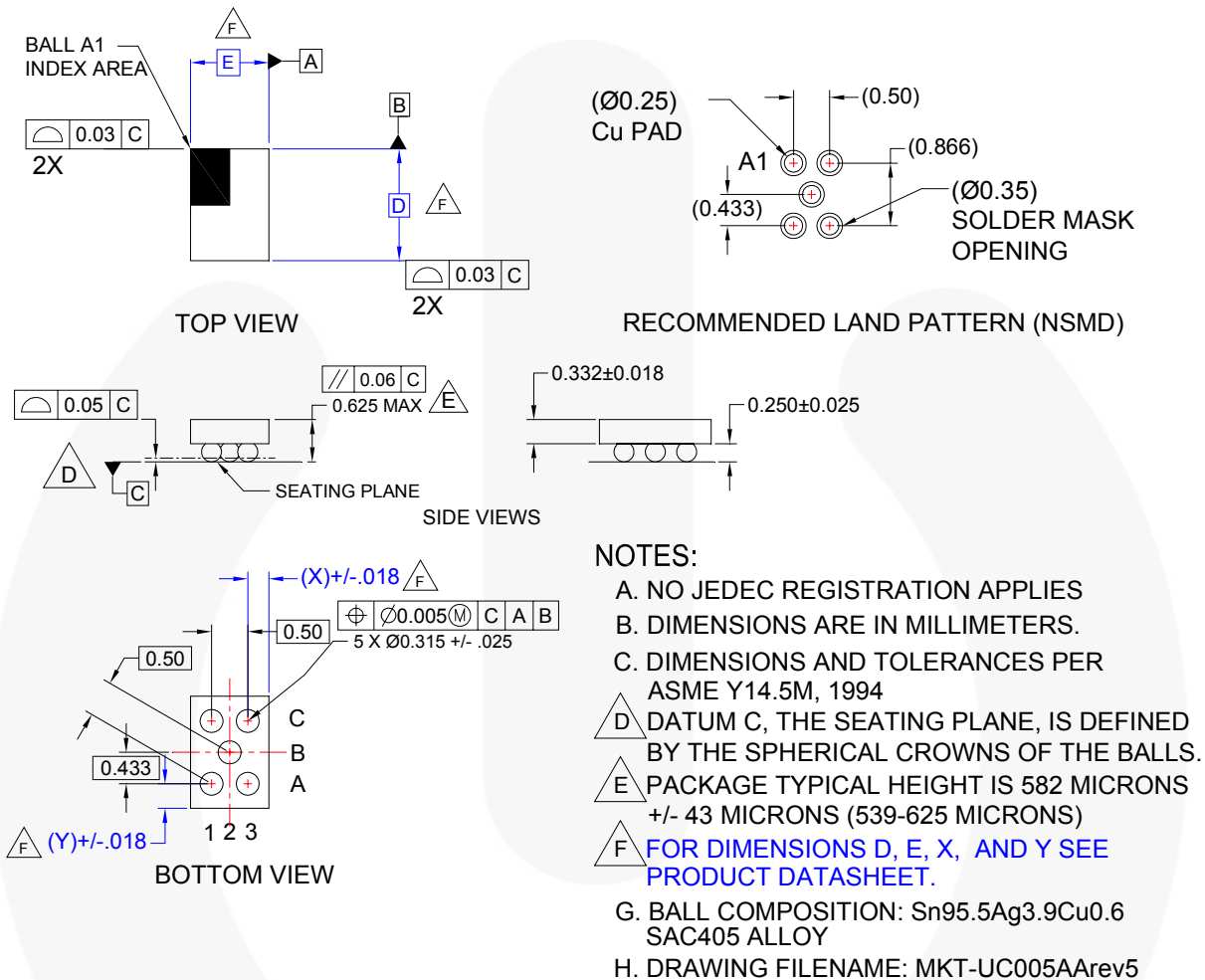

Figure 26. Wafer-Level Chip-Scale Packaging (WLCSPP)

Product Specific Dimensions

Product	D	E	X	Y
FAN2560UC13X	1.330 +/- 0.030	0.960 +/- 0.030	0.230	0.232
FAN2560UC15X	1.330 +/- 0.030	0.960 +/- 0.030	0.230	0.232







Package drawings are provided as a service to customers considering Fairchild components. Drawings may change in any manner without notice. Please note the revision and/or date on the drawing and contact a Fairchild Semiconductor representative to verify or obtain the most recent revision. Package specifications do not expand the terms of Fairchild's worldwide terms and conditions, specifically the warranty therein, which covers Fairchild products.

Always visit Fairchild Semiconductor's online packaging area for the most recent package drawings:
<http://www.fairchildsemi.com/packaging/>.



TRADEMARKS

The following includes registered and unregistered trademarks and service marks, owned by Fairchild Semiconductor and/or its global subsidiaries, and is not intended to be an exhaustive list of all such trademarks.

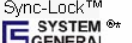
- | | | | |
|-----------------------------------------------------------------------------------|-----------------------------------------------------------------------------------|-----------------------------------------------------------------------------------|-------------------------------------------------------------------------------------|
| AccuPower™ | FPST™ | PowerTrench® | The Power Franchise® |
| Auto-SPM™ | F-PFST™ | PowerXS™ |  |
| Build it Now™ | FRFET® | Programmable Active Droop™ | TinyBoost™ |
| CorePLUS™ | Global Power Resource SM | QFET® | TinyBuck™ |
| CorePOWER™ | Green FPST™ | QS™ | TinyCalc™ |
| CROSSVOLT™ | Green FPST™ e-Series™ | Quiet Series™ | TinyLogic® |
| CTL™ | Gmax™ | RapidConfigure™ | TINYOPTO™ |
| Current Transfer Logic™ | GTO™ |  | TinyPower™ |
| EcoSPARK® | IntelliMAX™ | Saving our world, 1mV/VV/kW at a time™ | TinyPWM™ |
| EfficientMax™ | ISOPLANAR™ | SignalWise™ | TinyVire™ |
| EZSWITCH™ | MegaBuck™ | SmartMax™ | TriFault Detect™ |
|  | MICROCOUPLER™ | SMART START™ | TRUECURRENT™ |
|  | MicroFET™ | SPM® | μSerDes™ |
| Fairchild® | MicroPak™ | STEALTH™ |  |
| Fairchild Semiconductor® | MillerDrive™ | SuperFET™ | UHC® |
| FACT Quiet Series™ | MotionMax™ | SuperSOT™.3 | Ultra FRFET™ |
| FACT® | Motion-SPM™ | SuperSOT™.6 | UniFET™ |
| FACT® | OPTOLOGIC® | SuperSOT™.8 | VCX™ |
| FAST® | OPTOPLANAR® | SupreMOS™ | VisualMax™ |
| FastvCore™ |  | SyncFET™ | XST™ |
| FETBench™ | PDP SPM™ | Sync-Lock™ | |
| FlashWriter® | Power-SPM™ |  | |

* Trademarks of System General Corporation, used under license by Fairchild Semiconductor.

DISCLAIMER

FAIRCHILD SEMICONDUCTOR RESERVES THE RIGHT TO MAKE CHANGES WITHOUT FURTHER NOTICE TO ANY PRODUCTS HEREIN TO IMPROVE RELIABILITY, FUNCTION, OR DESIGN. FAIRCHILD DOES NOT ASSUME ANY LIABILITY ARISING OUT OF THE APPLICATION OR USE OF ANY PRODUCT OR CIRCUIT DESCRIBED HEREIN; NEITHER DOES IT CONVEY ANY LICENSE UNDER ITS PATENT RIGHTS, NOR THE RIGHTS OF OTHERS. THESE SPECIFICATIONS DO NOT EXPAND THE TERMS OF FAIRCHILD'S WORLDWIDE TERMS AND CONDITIONS, SPECIFICALLY THE WARRANTY THEREIN, WHICH COVERS THESE PRODUCTS.

LIFE SUPPORT POLICY

FAIRCHILD'S PRODUCTS ARE NOT AUTHORIZED FOR USE AS CRITICAL COMPONENTS IN LIFE SUPPORT DEVICES OR SYSTEMS WITHOUT THE EXPRESS WRITTEN APPROVAL OF FAIRCHILD SEMICONDUCTOR CORPORATION.

As used herein:

1. Life support devices or systems are devices or systems which, (a) are intended for surgical implant into the body or (b) support or sustain life, and (c) whose failure to perform when properly used in accordance with instructions for use provided in the labeling, can be reasonably expected to result in a significant injury of the user.
2. A critical component in any component of a life support, device, or system whose failure to perform can be reasonably expected to cause the failure of the life support device or system, or to affect its safety or effectiveness.

ANTI-COUNTERFEITING POLICY

Fairchild Semiconductor Corporation's Anti-Counterfeiting Policy. Fairchild's Anti-Counterfeiting Policy is also stated on our external website, www.fairchildsemi.com, under Sales Support.

Counterfeiting of semiconductor parts is a growing problem in the industry. All manufacturers of semiconductor products are experiencing counterfeiting of their parts. Customers who inadvertently purchase counterfeit parts experience many problems such as loss of brand reputation, substandard performance, failed applications, and increased cost of production and manufacturing delays. Fairchild is taking strong measures to protect ourselves and our customers from the proliferation of counterfeit parts. Fairchild strongly encourages customers to purchase Fairchild parts either directly from Fairchild or from Authorized Fairchild Distributors who are listed by country on our web page cited above. Products customers buy either from Fairchild directly or from Authorized Fairchild Distributors are genuine parts, have full traceability, meet Fairchild's quality standards for handling and storage and provide access to Fairchild's full range of up-to-date technical and product information. Fairchild and our Authorized Distributors will stand behind all warranties and will appropriately address any warranty issues that may arise. Fairchild will not provide any warranty coverage or other assistance for parts bought from Unauthorized Sources. Fairchild is committed to combat this global problem and encourage our customers to do their part in stopping this practice by buying direct or from authorized distributors.

PRODUCT STATUS DEFINITIONS

Definition of Terms

Datasheet Identification	Product Status	Definition
Advance Information	Formative / In Design	Datasheet contains the design specifications for product development. Specifications may change in any manner without notice.
Preliminary	First Production	Datasheet contains preliminary data; supplementary data will be published at a later date. Fairchild Semiconductor reserves the right to make changes at any time without notice to improve design.
No Identification Needed	Full Production	Datasheet contains final specifications. Fairchild Semiconductor reserves the right to make changes at any time without notice to improve the design.
Obsolete	Not In Production	Datasheet contains specifications on a product that is discontinued by Fairchild Semiconductor. The datasheet is for reference information only.

Rev. I42

ON Semiconductor and  are trademarks of Semiconductor Components Industries, LLC dba ON Semiconductor or its subsidiaries in the United States and/or other countries. ON Semiconductor owns the rights to a number of patents, trademarks, copyrights, trade secrets, and other intellectual property. A listing of ON Semiconductor's product/patent coverage may be accessed at www.onsemi.com/site/pdf/Patent-Marking.pdf. ON Semiconductor reserves the right to make changes without further notice to any products herein. ON Semiconductor makes no warranty, representation or guarantee regarding the suitability of its products for any particular purpose, nor does ON Semiconductor assume any liability arising out of the application or use of any product or circuit, and specifically disclaims any and all liability, including without limitation special, consequential or incidental damages. Buyer is responsible for its products and applications using ON Semiconductor products, including compliance with all laws, regulations and safety requirements or standards, regardless of any support or applications information provided by ON Semiconductor. "Typical" parameters which may be provided in ON Semiconductor data sheets and/or specifications can and do vary in different applications and actual performance may vary over time. All operating parameters, including "Typicals" must be validated for each customer application by customer's technical experts. ON Semiconductor does not convey any license under its patent rights nor the rights of others. ON Semiconductor products are not designed, intended, or authorized for use as a critical component in life support systems or any FDA Class 3 medical devices or medical devices with a same or similar classification in a foreign jurisdiction or any devices intended for implantation in the human body. Should Buyer purchase or use ON Semiconductor products for any such unintended or unauthorized application, Buyer shall indemnify and hold ON Semiconductor and its officers, employees, subsidiaries, affiliates, and distributors harmless against all claims, costs, damages, and expenses, and reasonable attorney fees arising out of, directly or indirectly, any claim of personal injury or death associated with such unintended or unauthorized use, even if such claim alleges that ON Semiconductor was negligent regarding the design or manufacture of the part. ON Semiconductor is an Equal Opportunity/Affirmative Action Employer. This literature is subject to all applicable copyright laws and is not for resale in any manner.

PUBLICATION ORDERING INFORMATION

LITERATURE FULFILLMENT:

Literature Distribution Center for ON Semiconductor
19521 E. 32nd Pkwy, Aurora, Colorado 80011 USA
Phone: 303-675-2175 or 800-344-3860 Toll Free USA/Canada
Fax: 303-675-2176 or 800-344-3867 Toll Free USA/Canada
Email: orderlit@onsemi.com

N. American Technical Support: 800-282-9855 Toll Free
USA/Canada
Europe, Middle East and Africa Technical Support:
Phone: 421 33 790 2910
Japan Customer Focus Center
Phone: 81-3-5817-1050

ON Semiconductor Website: www.onsemi.com
Order Literature: <http://www.onsemi.com/orderlit>
For additional information, please contact your local
Sales Representative