



Is Now Part of



ON Semiconductor®

To learn more about ON Semiconductor, please visit our website at
www.onsemi.com

Please note: As part of the Fairchild Semiconductor integration, some of the Fairchild orderable part numbers will need to change in order to meet ON Semiconductor's system requirements. Since the ON Semiconductor product management systems do not have the ability to manage part nomenclature that utilizes an underscore (_), the underscore (_) in the Fairchild part numbers will be changed to a dash (-). This document may contain device numbers with an underscore (_). Please check the ON Semiconductor website to verify the updated device numbers. The most current and up-to-date ordering information can be found at www.onsemi.com. Please email any questions regarding the system integration to Fairchild_questions@onsemi.com.

ON Semiconductor and the ON Semiconductor logo are trademarks of Semiconductor Components Industries, LLC dba ON Semiconductor or its subsidiaries in the United States and/or other countries. ON Semiconductor owns the rights to a number of patents, trademarks, copyrights, trade secrets, and other intellectual property. A listing of ON Semiconductor's product/patent coverage may be accessed at www.onsemi.com/site/pdf/Patent-Marking.pdf. ON Semiconductor reserves the right to make changes without further notice to any products herein. ON Semiconductor makes no warranty, representation or guarantee regarding the suitability of its products for any particular purpose, nor does ON Semiconductor assume any liability arising out of the application or use of any product or circuit, and specifically disclaims any and all liability, including without limitation special, consequential or incidental damages. Buyer is responsible for its products and applications using ON Semiconductor products, including compliance with all laws, regulations and safety requirements or standards, regardless of any support or applications information provided by ON Semiconductor. "Typical" parameters which may be provided in ON Semiconductor data sheets and/or specifications can and do vary in different applications and actual performance may vary over time. All operating parameters, including "Typicals" must be validated for each customer application by customer's technical experts. ON Semiconductor does not convey any license under its patent rights nor the rights of others. ON Semiconductor products are not designed, intended, or authorized for use as a critical component in life support systems or any FDA Class 3 medical devices or medical devices with a same or similar classification in a foreign jurisdiction or any devices intended for implantation in the human body. Should Buyer purchase or use ON Semiconductor products for any such unintended or unauthorized application, Buyer shall indemnify and hold ON Semiconductor and its officers, employees, subsidiaries, affiliates, and distributors harmless against all claims, costs, damages, and expenses, and reasonable attorney fees arising out of, directly or indirectly, any claim of personal injury or death associated with such unintended or unauthorized use, even if such claim alleges that ON Semiconductor was negligent regarding the design or manufacture of the part. ON Semiconductor is an Equal Opportunity/Affirmative Action Employer. This literature is subject to all applicable copyright laws and is not for resale in any manner.

FAN256 — Dual Low Voltage Comparator

Features

- Low Supply Current: $I_{DD}=7\mu A$ (Typical)
- Single Power Supply Operation
- Wide Common-Mode Input Voltage Range: Rail-to-Rail
- Push-Pull Output Circuit
- Low Input Bias Current
- Internal Hysteresis
- Packaged in MicroPak™ 8 (1.6mm x 1.6mm)

Applications

- Mobile Phones
- Alarm and Security Systems
- Personal Digital Assistants

Description

The FAN256 is a low-power, dual comparator that typically consumes less than $10\mu A$ supply current per comparator. Guaranteed to operate at a low voltage of 1.6V and fully operational up to 5.5V, it is convenient for use in 1.8, 3.0V, and 5.0V systems.

The FAN256 has a complementary push-pull P- and N-channel output stage capable of driving a rail-to-rail output swing with a load ranging up to 5.0mA.

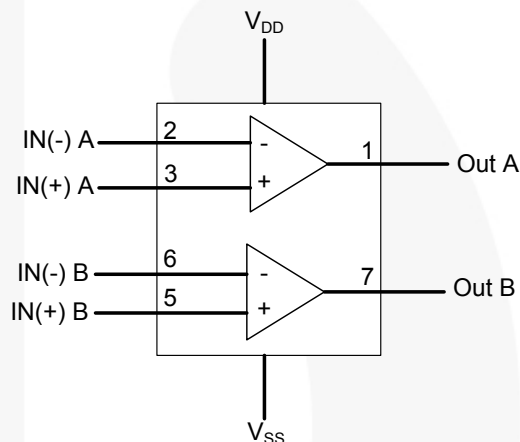

Figure 1. Functional Diagram

Ordering Information

| Part Number | Top Mark | Operating Temperature Range | Package | Packing Method |
|-------------|----------|-----------------------------|---|-----------------------------|
| FAN256L8X | CP | -40 to 85°C | 8-Lead, MicroPak™ 1.6mm x 1.6mm Package | 5000 Units on Tape and Reel |

Pin Configuration

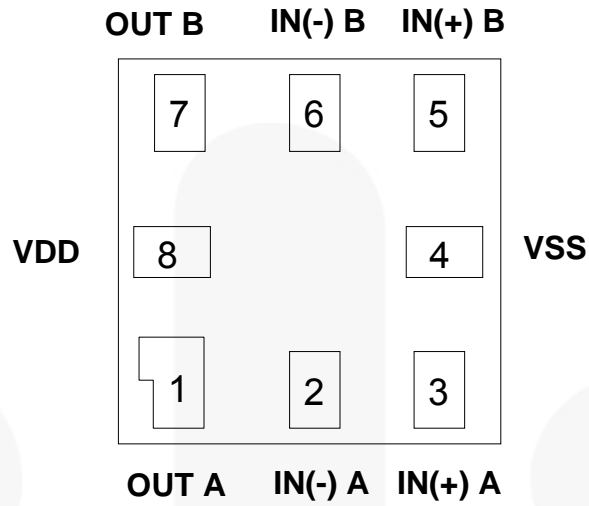

Figure 2. Pin Configuration (Top Through View)

Pin Definitions

| Pin # | Name | Description |
|-------|---------|-------------------------------------|
| 1 | OUT A | Comparator A Output |
| 2 | IN(-) A | Inverting Input of Comparator A |
| 3 | IN(+) A | Non-Inverting Input of Comparator A |
| 4 | VSS | Negative Supply Voltage |
| 5 | IN(+) B | Non-Inverting Input of Comparator B |
| 6 | IN(-) B | Inverting Input of Comparator B |
| 7 | OUT B | Comparator B Output |
| 8 | VDD | Positive Supply Voltage |

Function Table

| Inputs | Outputs |
|-----------------|-------------|
| $IN(-) > IN(+)$ | Output LOW |
| $IN(+ > IN(-)$ | Output HIGH |

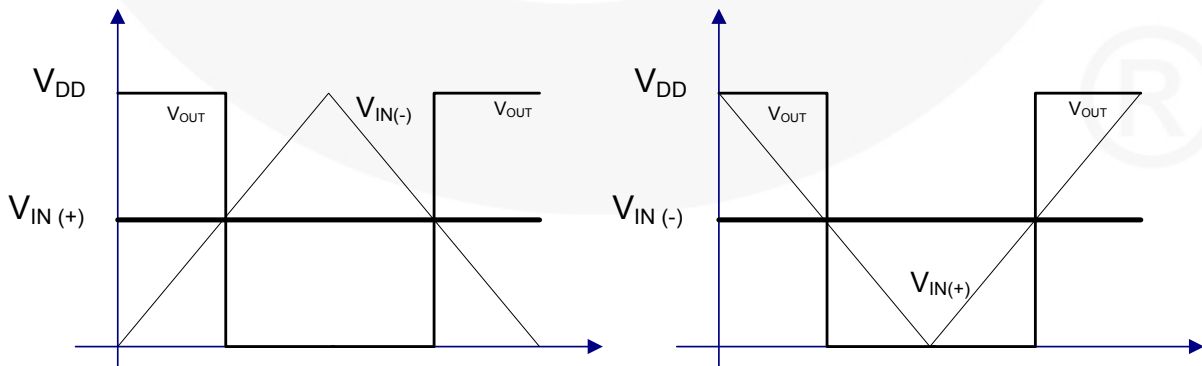

Figure 3. V_{IN} vs. V_{OUT}

Absolute Maximum Ratings

Stresses exceeding the absolute maximum ratings may damage the device. The device may not function or be operable above the recommended operating conditions and stressing the parts to these levels is not recommended. In addition, extended exposure to stresses above the recommended operating conditions may affect device reliability. The absolute maximum ratings are stress ratings only.

| Symbol | Parameter | Condition | Min. | Max. | Unit |
|---|--|--|------|----------------------|------|
| V_{DD} to V_{SS} | Supply Voltage | | -3.0 | +3.0 | V |
| | | | 0 | 6.0 | |
| DV_{IN} | Differential Input Voltage | | | ± 6 | |
| V_{IN} | Input Voltage | | | V_{SS} to V_{DD} | V |
| t_s | Output Short Circuit Duration ⁽¹⁾ | | | Indefinite | S |
| T_J | Junction Temperature | | | +150 | °C |
| T_{STG} | Storage Temperature Range | | -65 | +150 | °C |
| P_D | Power Dissipation | | | 226 | mW |
| Θ_{JA} | Thermal Resistance | | | 287 | °C/W |
| ESD | IEC 61000-4-2 System ESD | Air Gap | | 15 | kV |
| | | Contact | | 8 | |
| | JEDEC JESD22-A114, Human Body Model | All Pins | | 8 | |
| | | Pin to Pin: IN(-), IN(+) to V_{DD} or V_{SS} | | 12 | |
| JEDEC JESD22-C101, Charged Device Model | All Pins | | 2 | | |

Note:

- The maximum total power dissipation must not be exceeded.

Recommended Operating Conditions

The Recommended Operating Conditions table defines the conditions for actual device operation. Recommended operating conditions are specified to ensure optimal performance to the datasheet specifications. Fairchild does not recommend exceeding them or designing to Absolute Maximum Ratings.

| Symbol | Parameter | Condition | Min. | Max. | Unit |
|----------------------|---------------------------------|---------------|-------|----------------------|------|
| V_{DD} to V_{SS} | Power Supply | | -2.75 | +2.75 | V |
| | | | 0 | 5.5 | |
| V_{DD} | Power Supply | $V_{SS}=0V$ | 1.6 | 5.5 | V |
| V_{IN} | Input Voltage | | | V_{SS} to V_{DD} | V |
| I_{OH}/I_{OL} | Output Sink/Source Current | $V_{DD}=5.0V$ | | 5 | mA |
| | | $V_{DD}=3.0V$ | | 3 | |
| | | $V_{DD}=1.6V$ | | 1 | |
| T_A | Operating Temperature, Free Air | | -40 | +85 | °C |

Electrical Characteristics

| Symbol | Parameter | Condition | Min. | Typ. | Max. | Unit |
|---|--|---|-----------------|------|-----------------|------|
| V_{DD}=5.5V, V_{SS}=GND, and T_A=+25°C | | | | | | |
| V _{HYS} | Input Hysteresis | V _{CM} =0.5V _{DD} | | 4 | | mV |
| V _{IO} | Input Offset Voltage ⁽²⁾ | V _{CM} =0.5V _{DD} | -15 | ±1 | +15 | mV |
| I _{IO} | Input Offset Current | | | 10 | | pA |
| I _I | Input Bias Current | | | 10 | | pA |
| V _{CM} | Common Mode Input Voltage | | V _{SS} | | V _{DD} | V |
| CMRR | Common Mode Rejection Ratio ⁽³⁾ | V _{CM} =V _{DD} | | 68 | | dB |
| I _{DD} | Supply Current - Per Comparator | | | 7 | 17 | µA |
| PSRR | Power Supply Rejection Ratio ⁽³⁾ | ΔV _{DD} =0.5V | 45 | 80 | | dB |
| I _{OS} | Output Short Circuit Current | V _O =V _{DD} | | 60 | | mA |
| | | V _O =V _{SS} | | 90 | | |
| V _{OL} | Low-Level Output Voltage | I _{SINK} =5.0mA | | 0.1 | 0.3 | V |
| V _{OH} | High-Level Output Voltage | I _{SOURCE} =5.0mA | 5.2 | 5.4 | | V |
| t _{PLH} | Propagation Delay (Turn-On) | Overdrive=20mV, C _L =15pF | | 0.40 | | µs |
| t _{PHL} | Propagation Delay (Turn-Off) | Overdrive=20mV, C _L =15pF | | 0.42 | | µs |
| t _{TLH} | Response Time, Output Rise/Fall ⁽⁴⁾ | C _L =50pF | | 4.0 | | ns |
| t _{THL} | | | | 5.4 | | |
| V_{DD}=3V, V_{SS}=GND, and T_A=+25°C | | | | | | |
| V _{HYS} | Input Hysteresis | V _{CM} =0.5V _{DD} | | 4 | | mV |
| V _{IO} | Input Offset Voltage ⁽²⁾ | V _{CM} =0.5V _{DD} | -15 | ±1 | +15 | mV |
| I _{IO} | Input Offset Current | | | 10 | | pA |
| I _I | Input Bias Current | | | 10 | | pA |
| V _{CM} | Common Mode Input Voltage | | V _{SS} | | V _{DD} | V |
| CMRR | Common Mode Rejection Ratio ⁽³⁾ | V _{CM} =V _{DD} | | 60 | | dB |
| I _{DD} | Supply Current(x) Per Comparator | | | 6 | 15 | µA |
| PSRR | Power Supply Rejection Ratio ⁽³⁾ | ΔV _{DD} =0.5V | 45 | 70 | | dB |
| I _{OS} | Output Short Circuit Current | V _O =V _{DD} | | 27 | | mA |
| | | V _O =V _{SS} | | 35 | | |
| V _{OL} | Low-Level Output Voltage | I _{SINK} =3.0mA | | 0.15 | 0.35 | V |
| V _{OH} | High-Level Output Voltage | I _{SOURCE} =3.0mA | 2.65 | 2.85 | | V |
| t _{PLH} | Propagation Delay (Turn-On) | Overdrive=20mV, C _L =15pF | | 0.45 | | µs |
| t _{PHL} | Propagation Delay (Turn-Off) | Overdrive=20mV, C _L =15pF | | 0.47 | | µs |
| t _{TLH} | Response Time, Output Rise/Fall ⁽⁴⁾ | C _L =50pF | | 6.1 | | ns |
| t _{THL} | | | | 6.2 | | |

Continued on the following page...

Electrical Characteristics

| Symbol | Parameter | Condition | Min. | Typ. | Max. | Unit |
|---|--|---|-----------------|------|-----------------|------|
| V_{DD}=1.6V, V_{SS}=GND, and T_A=+25°C | | | | | | |
| V _{HYS} | Input Hysteresis | V _{CM} =0.5V _{DD} | | 3.5 | | mV |
| V _{IO} | Input Offset Voltage ⁽²⁾ | V _{CM} =0.5V _{DD} | -15 | ±1 | +15 | mV |
| I _{IO} | Input Offset Current | | | 10 | | pA |
| I _I | Input Bias Current | | | 10 | | pA |
| V _{CM} | Common Mode Input Voltage | | V _{SS} | | V _{DD} | V |
| CMRR | Common Mode Rejection Ratio ⁽³⁾ | V _{CM} =V _{DD} | | 56 | | dB |
| I _{DD} | Supply Current(x) Per Comparator | | | 5 | 13 | µA |
| PSRR | Power Supply Rejection Ratio ⁽³⁾ | ΔV _{DD} =0.5V | 45 | 70 | | dB |
| I _{OS} | Output Short Circuit Current | V _O =V _{DD} | | 5.5 | | mA |
| | | V _O =V _{SS} | | 7.5 | | |
| V _{OL} | Low-Level Output Voltage | I _{SINK} =1.0mA | | 0.15 | 0.25 | V |
| V _{OH} | High-Level Output Voltage | I _{SOURCE} =1.0mA | 1.35 | 1.50 | | V |
| t _{PLH} | Propagation Delay (Turn-On) | Overdrive=20mV, C _L =15pF | | 0.52 | | µs |
| t _{PHL} | Propagation Delay (Turn-Off) | Overdrive=20mV, C _L =15pF | | 0.54 | | µs |
| t _{TLH} | Response Time, Output Rise/Fall ⁽⁴⁾ | C _L =50pF | | 16.5 | | ns |
| t _{THL} | | | | 13.0 | | |

Notes:

- Differential input switching level is guaranteed at the minimum or maximum offset voltage, minus or plus half the maximum hysteresis voltage.
- Guaranteed by design and characterization data
- Input signal: 1kHz, square-wave signal with 10ns edge rate.

Typical Performance Characteristics

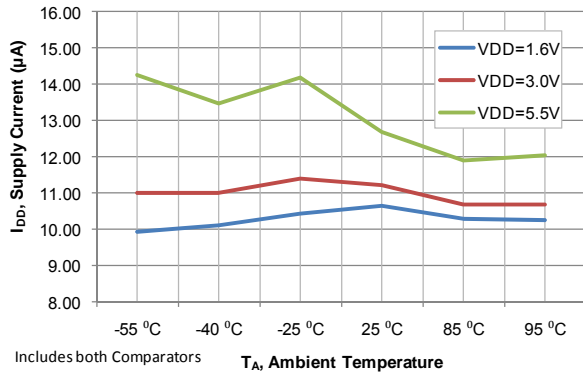

Figure 4. Supply Current vs. Temperature

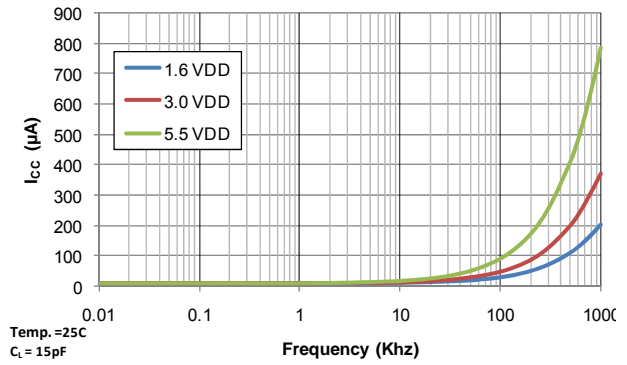

Figure 5. Supply Current vs. Output Transition Frequency

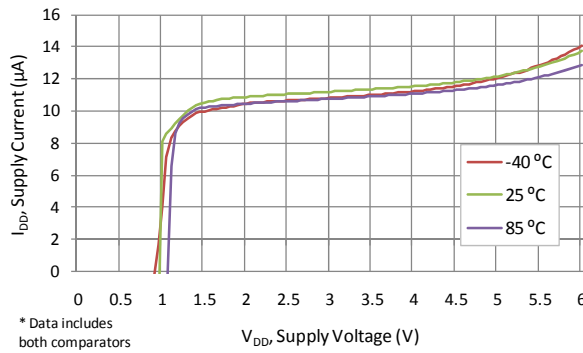

Figure 6. Supply Current vs. Supply Voltage

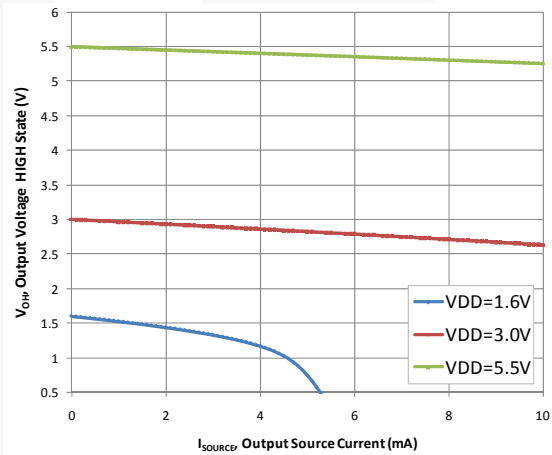

Figure 7. Output HIGH vs. Output Drive Current

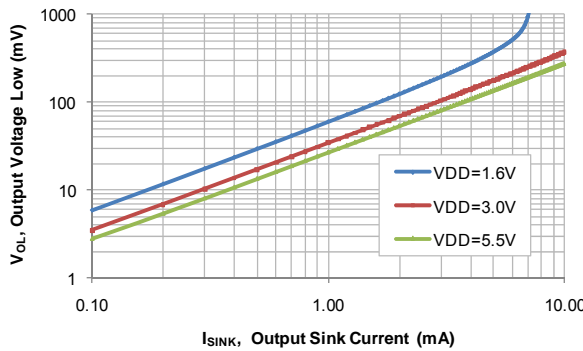

Figure 8. Output LOW vs. Output Drive Current

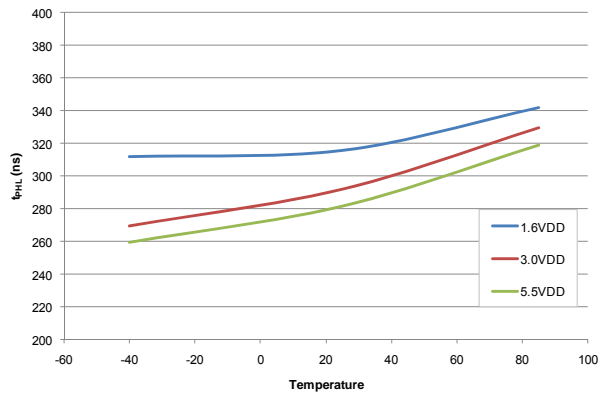

Figure 9. Propagation Delay (t_{PLH}) vs. Temperature

Typical Performance Characteristics (Continued)

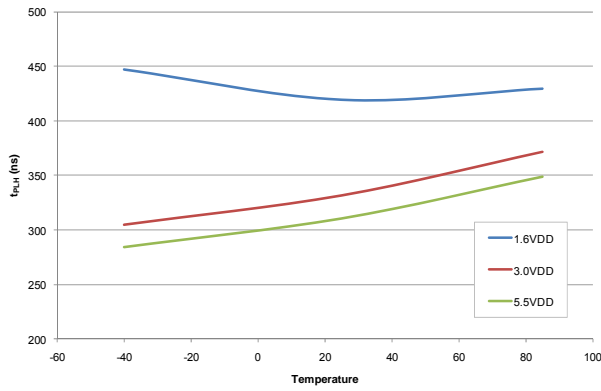

Figure 10. Propagation Delay (t_{PLH}) vs. Temperature

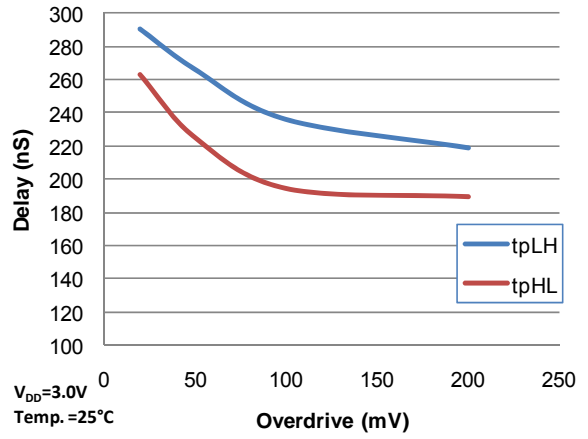

Figure 11. Propagation Delay vs. Input Overdrive

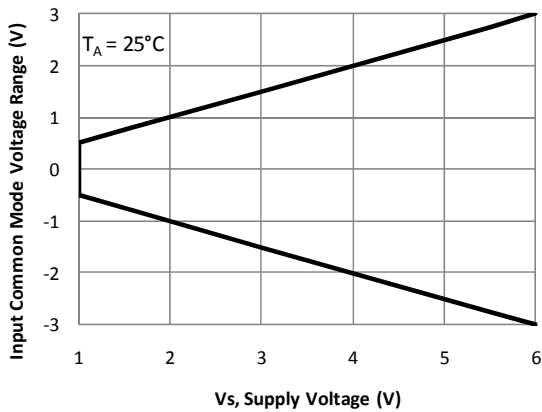

Figure 12. Input Common Mode Voltage Range vs. Supply Voltage

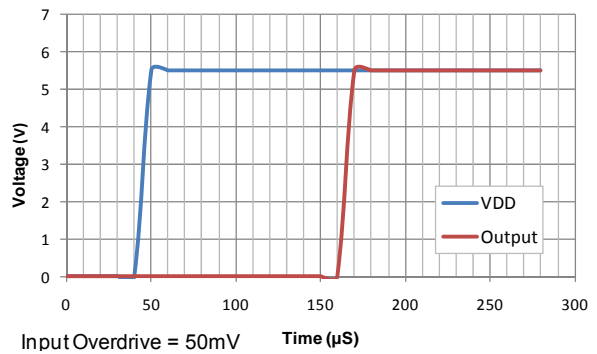
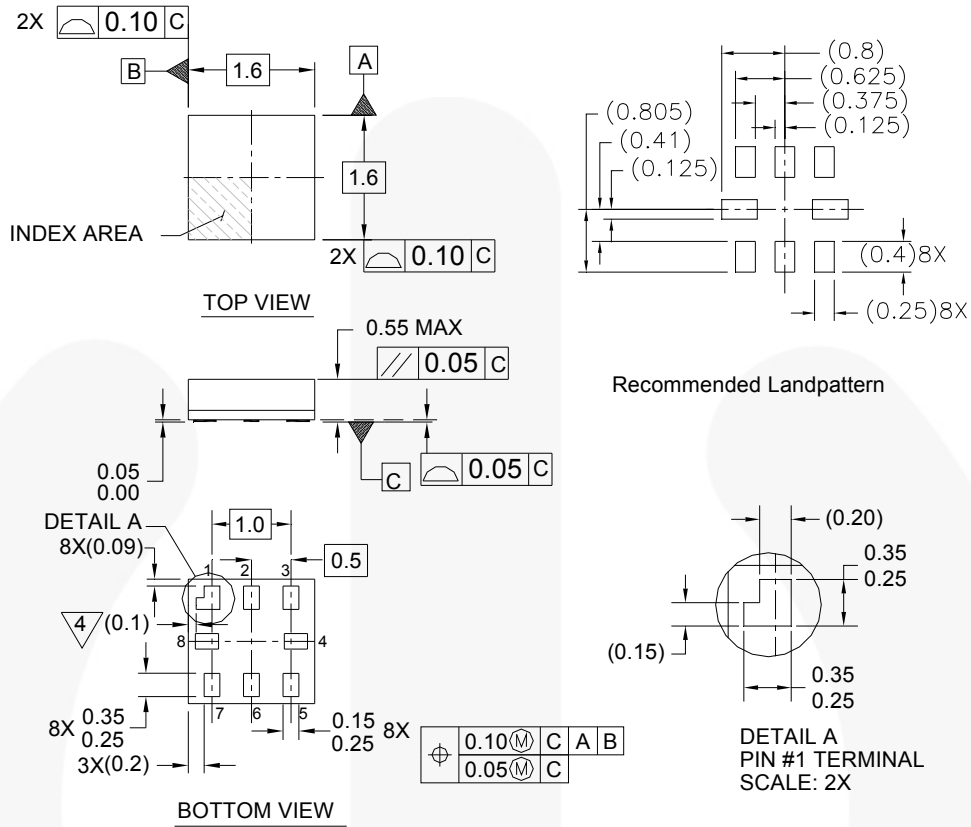

Figure 13. Power-Up Delay

Physical Dimensions



Notes:

1. PACKAGE CONFORMS TO JEDEC MO-255 VARIATION UAAD
2. DIMENSIONS ARE IN MILLIMETERS
3. DRAWING CONFORMS TO ASME Y.14M-1994
4. PIN 1 FLAG, END OF PACKAGE OFFSET
5. DRAWING FILE NAME: MKT-MAC08AREV4

MAC08AREV4

Figure 14. 8-Lead, MicroPak™ 1.6mm Wide

Package drawings are provided as a service to customers considering Fairchild components. Drawings may change in any manner without notice. Please note the revision and/or date on the drawing and contact a Fairchild Semiconductor representative to verify or obtain the most recent revision. Package specifications do not expand the terms of Fairchild's worldwide terms and conditions, specifically the warranty therein, which covers Fairchild products.

Always visit Fairchild Semiconductor's online packaging area for the most recent package drawings:
<http://www.fairchildsemi.com/packaging/>





Tape and Reel Specifications

Please visit Fairchild Semiconductor's online packaging area for the most recent tape and reel specifications:
http://www.fairchildsemi.com/products/logic/pdf/micropak_tr.pdf/



TRADEMARKS

The following includes registered and unregistered trademarks and service marks, owned by Fairchild Semiconductor and/or its global subsidiaries, and is not intended to be an exhaustive list of all such trademarks.

| | | | |
|---|---|---|---|
| AccuPower™ | FPS™ | Power-SPM™ | The Power Franchise® |
| Auto-SPM™ | F-PFS™ | PowerTrench® | The Right Technology for Your Success™ |
| AX-CAPT™ | FRFET® | PowerXS™ | the power franchises |
| BitSic® | Global Power Resource™ | Programmable Active Droop™ | TinyBoost™ |
| Build it Now™ | Green FPS™ | QFET® | TinyBuck™ |
| CorePLUS™ | Green FPS™ e-Series™ | QS™ | TinyCalc™ |
| CorePOWER™ | Gmax™ | Quiet Series™ | TinyLogic® |
| CROSSVOLT™ | GTO™ | RapidConfigure™ | TINYOPTO™ |
| CTL™ | IntelliMAX™ |  | TinyPower™ |
| Current Transfer Logic™ | ISOPLANAR™ | Saving our world, 1mW/W/kW at a time™ | TinyPVM™ |
| DEUXPEED® | MegaBuck™ | SignalWise™ | TinyWire™ |
| Dual Cool™ | MICROCOUPLER™ | SmartMax™ | TranSIC® |
| EcoSPARK® | MicroFET™ | SMART START™ | TriFault Detect™ |
| EfficientMax™ | MicroPak™ | SPM® | TRUECURRENT®* |
| ESBCTM | MicroPak2™ | STEALTH™ | µSerDes™ |
|  | MillerDrive™ | SuperFET® |  |
| Fairchild® | MotionMax™ | SuperSOT™-3 | UHC® |
| Fairchild Semiconductor® | Motion-SPM™ | SuperSOT™-8 | Ultra FRFET™ |
| FACT Quiet Series™ | mWSaver™ | SupreMOS® | UniFET™ |
| FACT™ | OptoHi™ | SyncFET™ | Vcx™ |
| FAST® | OPTOLOGIC® | Sync-Lock™ | VisualMax™ |
| FastvCore™ | OPTOPLANAR® |  | XS™ |
| FETBench™ |  | | |
| FlashWriter®* | PDP SPM™ | | |

* Trademarks of System General Corporation, used under license by Fairchild Semiconductor.

DISCLAIMER

FAIRCHILD SEMICONDUCTOR RESERVES THE RIGHT TO MAKE CHANGES WITHOUT FURTHER NOTICE TO ANY PRODUCTS HEREIN TO IMPROVE RELIABILITY, FUNCTION, OR DESIGN. FAIRCHILD DOES NOT ASSUME ANY LIABILITY ARISING OUT OF THE APPLICATION OR USE OF ANY PRODUCT OR CIRCUIT DESCRIBED HEREIN, NEITHER DOES IT CONVEY ANY LICENSE UNDER ITS PATENT RIGHTS, NOR THE RIGHTS OF OTHERS. THESE SPECIFICATIONS DO NOT EXPAND THE TERMS OF FAIRCHILD'S WORLDWIDE TERMS AND CONDITIONS, SPECIFICALLY THE WARRANTY THEREIN, WHICH COVERS THESE PRODUCTS.

LIFE SUPPORT POLICY

FAIRCHILD'S PRODUCTS ARE NOT AUTHORIZED FOR USE AS CRITICAL COMPONENTS IN LIFE SUPPORT DEVICES OR SYSTEMS WITHOUT THE EXPRESS WRITTEN APPROVAL OF FAIRCHILD SEMICONDUCTOR CORPORATION.

As used herein:

1. Life support devices or systems are devices or systems which, (a) are intended for surgical implant into the body or (b) support or sustain life, and (c) whose failure to perform when properly used in accordance with instructions for use provided in the labeling, can be reasonably expected to result in a significant injury of the user.
2. A critical component in any component of a life support device, or system whose failure to perform can be reasonably expected to cause the failure of the life support device or system, or to affect its safety or effectiveness.

ANTI-COUNTERFEITING POLICY

Fairchild Semiconductor Corporation's Anti-Counterfeiting Policy. Fairchild's Anti-Counterfeiting Policy is also stated on our external website, www.fairchildsemi.com, under Sales Support.

Counterfeiting of semiconductor parts is a growing problem in the industry. All manufacturers of semiconductor products are experiencing counterfeiting of their parts. Customers who inadvertently purchase counterfeit parts experience many problems such as loss of brand reputation, substandard performance, failed applications, and increased cost of production and manufacturing delays. Fairchild is taking strong measures to protect ourselves and our customers from the proliferation of counterfeit parts. Fairchild strongly encourages customers to purchase Fairchild parts either directly from Fairchild or from Authorized Fairchild Distributors who are listed by country on our web page cited above. Products customers buy either from Fairchild directly or from Authorized Fairchild Distributors are genuine parts, have full traceability, meet Fairchild's quality standards for handling and storage and provide access to Fairchild's full range of up-to-date technical and product information. Fairchild and our Authorized Distributors will stand behind all warranties and will appropriately address any warranty issues that may arise. Fairchild will not provide any warranty coverage or other assistance for parts bought from Unauthorized Sources. Fairchild is committed to combat this global problem and encourage our customers to do their part in stopping this practice by buying direct or from authorized distributors.

PRODUCT STATUS DEFINITIONS

Definition of Terms

| Datasheet Identification | Product Status | Definition |
|--------------------------|-----------------------|---|
| Advance Information | Formative / In Design | Datasheet contains the design specifications for product development. Specifications may change in any manner without notice. |
| Preliminary | First Production | Datasheet contains preliminary data; supplementary data will be published at a later date. Fairchild Semiconductor reserves the right to make changes at any time without notice to improve design. |
| No Identification Needed | Full Production | Datasheet contains final specifications. Fairchild Semiconductor reserves the right to make changes at any time without notice to improve the design. |
| Obsolete | Not In Production | Datasheet contains specifications on a product that is discontinued by Fairchild Semiconductor. The datasheet is for reference information only. |

Rev. 154

ON Semiconductor and  are trademarks of Semiconductor Components Industries, LLC dba ON Semiconductor or its subsidiaries in the United States and/or other countries. ON Semiconductor owns the rights to a number of patents, trademarks, copyrights, trade secrets, and other intellectual property. A listing of ON Semiconductor's product/patent coverage may be accessed at www.onsemi.com/site/pdf/Patent-Marking.pdf. ON Semiconductor reserves the right to make changes without further notice to any products herein. ON Semiconductor makes no warranty, representation or guarantee regarding the suitability of its products for any particular purpose, nor does ON Semiconductor assume any liability arising out of the application or use of any product or circuit, and specifically disclaims any and all liability, including without limitation special, consequential or incidental damages. Buyer is responsible for its products and applications using ON Semiconductor products, including compliance with all laws, regulations and safety requirements or standards, regardless of any support or applications information provided by ON Semiconductor. "Typical" parameters which may be provided in ON Semiconductor data sheets and/or specifications can and do vary in different applications and actual performance may vary over time. All operating parameters, including "Typicals" must be validated for each customer application by customer's technical experts. ON Semiconductor does not convey any license under its patent rights nor the rights of others. ON Semiconductor products are not designed, intended, or authorized for use as a critical component in life support systems or any FDA Class 3 medical devices or medical devices with a same or similar classification in a foreign jurisdiction or any devices intended for implantation in the human body. Should Buyer purchase or use ON Semiconductor products for any such unintended or unauthorized application, Buyer shall indemnify and hold ON Semiconductor and its officers, employees, subsidiaries, affiliates, and distributors harmless against all claims, costs, damages, and expenses, and reasonable attorney fees arising out of, directly or indirectly, any claim of personal injury or death associated with such unintended or unauthorized use, even if such claim alleges that ON Semiconductor was negligent regarding the design or manufacture of the part. ON Semiconductor is an Equal Opportunity/Affirmative Action Employer. This literature is subject to all applicable copyright laws and is not for resale in any manner.

PUBLICATION ORDERING INFORMATION

LITERATURE FULFILLMENT:

Literature Distribution Center for ON Semiconductor
19521 E. 32nd Pkwy, Aurora, Colorado 80011 USA
Phone: 303-675-2175 or 800-344-3860 Toll Free USA/Canada
Fax: 303-675-2176 or 800-344-3867 Toll Free USA/Canada
Email: orderlit@onsemi.com

N. American Technical Support: 800-282-9855 Toll Free
USA/Canada
Europe, Middle East and Africa Technical Support:
Phone: 421 33 790 2910
Japan Customer Focus Center
Phone: 81-3-5817-1050

ON Semiconductor Website: www.onsemi.com
Order Literature: <http://www.onsemi.com/orderlit>
For additional information, please contact your local
Sales Representative