



Is Now Part of



**ON Semiconductor®**

To learn more about ON Semiconductor, please visit our website at  
[www.onsemi.com](http://www.onsemi.com)

Please note: As part of the Fairchild Semiconductor integration, some of the Fairchild orderable part numbers will need to change in order to meet ON Semiconductor's system requirements. Since the ON Semiconductor product management systems do not have the ability to manage part nomenclature that utilizes an underscore (\_), the underscore (\_) in the Fairchild part numbers will be changed to a dash (-). This document may contain device numbers with an underscore (\_). Please check the ON Semiconductor website to verify the updated device numbers. The most current and up-to-date ordering information can be found at [www.onsemi.com](http://www.onsemi.com). Please email any questions regarding the system integration to [Fairchild\\_questions@onsemi.com](mailto:Fairchild_questions@onsemi.com).

ON Semiconductor and the ON Semiconductor logo are trademarks of Semiconductor Components Industries, LLC dba ON Semiconductor or its subsidiaries in the United States and/or other countries. ON Semiconductor owns the rights to a number of patents, trademarks, copyrights, trade secrets, and other intellectual property. A listing of ON Semiconductor's product/patent coverage may be accessed at [www.onsemi.com/site/pdf/Patent-Marking.pdf](http://www.onsemi.com/site/pdf/Patent-Marking.pdf). ON Semiconductor reserves the right to make changes without further notice to any products herein. ON Semiconductor makes no warranty, representation or guarantee regarding the suitability of its products for any particular purpose, nor does ON Semiconductor assume any liability arising out of the application or use of any product or circuit, and specifically disclaims any and all liability, including without limitation special, consequential or incidental damages. Buyer is responsible for its products and applications using ON Semiconductor products, including compliance with all laws, regulations and safety requirements or standards, regardless of any support or applications information provided by ON Semiconductor. "Typical" parameters which may be provided in ON Semiconductor data sheets and/or specifications can and do vary in different applications and actual performance may vary over time. All operating parameters, including "Typicals" must be validated for each customer application by customer's technical experts. ON Semiconductor does not convey any license under its patent rights nor the rights of others. ON Semiconductor products are not designed, intended, or authorized for use as a critical component in life support systems or any FDA Class 3 medical devices or medical devices with a same or similar classification in a foreign jurisdiction or any devices intended for implantation in the human body. Should Buyer purchase or use ON Semiconductor products for any such unintended or unauthorized application, Buyer shall indemnify and hold ON Semiconductor and its officers, employees, subsidiaries, affiliates, and distributors harmless against all claims, costs, damages, and expenses, and reasonable attorney fees arising out of, directly or indirectly, any claim of personal injury or death associated with such unintended or unauthorized use, even if such claim alleges that ON Semiconductor was negligent regarding the design or manufacture of the part. ON Semiconductor is an Equal Opportunity/Affirmative Action Employer. This literature is subject to all applicable copyright laws and is not for resale in any manner.

# FAN7601

## Green Current Mode PWM Controller

### Features

- Green Current Mode PWM Control
- Low Operating Current: Max 4mA
- Burst Mode Operation
- Internal High Voltage Start-up Switch
- Under Voltage Lockout (UVLO): 12V/8V
- Latch Protection & Soft Start Function
- Over Voltage Protection: 19V
- Operating Frequency up to 300kHz
- Max Duty Cycle: 95%

### Typical Applications

- Off-Line Adapter Applications
- Auxiliary Power Supplies

### Description

The FAN7601 is a green programmable frequency current mode PWM controller. It is specially designed for the off-line adapter application and the auxiliary power supplies which require high efficiency at a light load and no load. The internal high voltage start-up switch and the burst mode reduce the power loss. The FAN7601 includes some protections such as latch protection and over voltage protection. The latch protection can be used for over voltage protection and/or thermal protection and so on. And the soft start prevents the output voltage over shoot at start up.

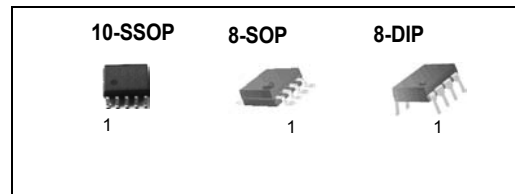

### Internal Block Diagram

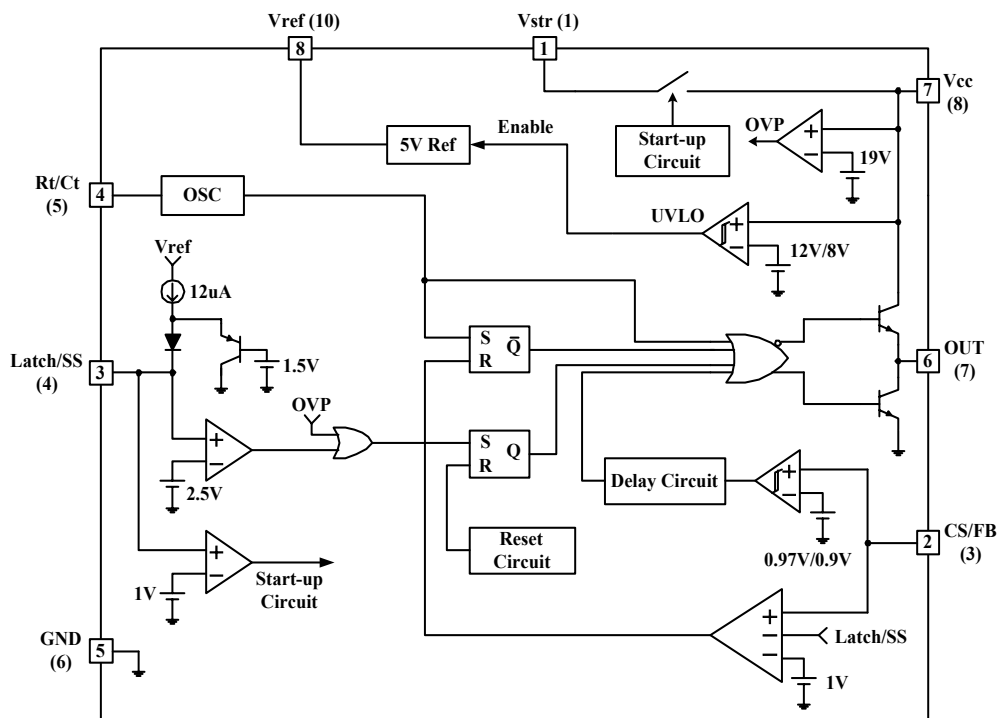

\* ( ) is 10-SSOP PIN Number

## Pin Assignments

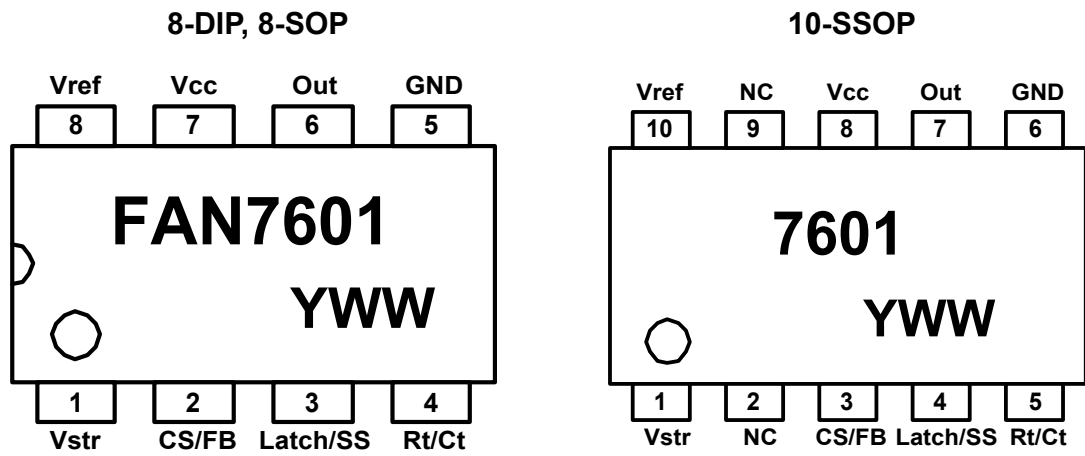

## Pin Definitions

| Pin Number | Pin Name | Pin Function Description        |
|------------|----------|---------------------------------|
| 1 (1)      | Vstr     | Start-up                        |
| 2 (3)      | CS/FB    | Current Sense and Feedback      |
| 3 (4)      | Latch/SS | Latch Protection and Soft Start |
| 4 (5)      | Rt/Ct    | Oscillator Timing               |
| 5 (6)      | GND      | Ground                          |
| 6 (7)      | Out      | Gate Drive Output               |
| 7 (8)      | VCC      | IC Power Supply                 |
| 8 (10)     | Vref     | Voltage Reference               |

\*() is 10-SSOP PIN Number

## Absolute Maximum Ratings

(Ta = 25°C, unless otherwise specified)

| Characteristics   | Symbol  | Value       | Unit |
|---|---------|-------------|------|
| Supply Voltage  | VCC     | 20          | V    |
| Input Voltage CS/FB   | VCS/FB  | -0.3 to 20  | V    |
| Operating Temperature                                       | TOPR    | -25 to +125 | °C   |
| Storage Temperature   | TSTG    | -55 to +150 | °C   |
| Junction Temperature  | Tj      | 150         | °C   |
| Output Current  | IO      | 250         | mA   |
| Vstr Input Voltage  | Vstr    | 500         | V    |
| ESD Capability, HBM Model<br>(All pins except Vcc and Vstr) | -       | 2.0         | kV   |
| ESD Capability, Machine Model                               | -       | 300         | V    |
| Thermal Resistance, Junction to Air                         | 8-DIP   | 100         | °C/W |
|   | 8-SOP   | 180         |      |
|   | 10-SSOP | 130         |      |

## Electrical Characteristics

( $T_a = -25^{\circ}\text{C} \sim 125^{\circ}\text{C}$ ,  $V_{CC} = 14\text{V}$ ,  $R_t = 9.5\text{k}\Omega$ ,  $C_t = 2.2\text{nF}$  unless otherwise specified)

| Characteristics                         | Symbol                   | Conditions   | Min. | Typ. | Max. | Unit          |
|---|--------------------------|--|------|------|------|---------------|
| <b>REFERENCE SECTION</b>                |                          |  |      |      |      |               |
| Reference Output Voltage                | $V_{\text{ref}}$         | $I_O = 1\text{mA}$   | 4.85 | 5.00 | 5.15 | V             |
| Line Regulation                         | $\Delta V_{\text{ref1}}$ | $V_{CC} = 10\text{V} \sim 18\text{V}$                      | -    | 10   | 20   | mV            |
| Load Regulation                         | $\Delta V_{\text{ref2}}$ | $I_O = 1\text{mA} \sim 10\text{mA}$                        | -    | 20   | 30   | mV            |
| <b>OSCILLATOR SECTION</b>               |                          |  |      |      |      |               |
| Initial Accuracy                        | FOSC                     | -  | 90   | 100  | 110  | kHz           |
| Voltage Stability                       | STV                      | $V_{CC} = 10\text{V} \sim 18\text{V}$                      | -    | 1.0  | 1.5  | %             |
| Amplitude                               | VOCS                     | $V_{\text{pin4}}$ peak-to-peak                             | -    | 1.25 | -    | V             |
| <b>PWM SECTION</b>                      |                          |  |      |      |      |               |
| CS/FB Threshold Voltage1                | VCS/FB1                  | -  | 0.9  | 1.0  | 1.1  | V             |
| Maximum Duty Cycle                      | DMAX                     | $T_a = 25^{\circ}\text{C}$                                 | 92   | 95   | 98   | %             |
| Minimum Duty Cycle                      | DMIN                     | -  | -    | -    | 0    | %             |
| <b>BURST MODE SECTION</b>               |                          |  |      |      |      |               |
| CS/FB Threshold Voltage2 <sup>(1)</sup> | VCS/FB2                  | -  | 0.77 | 0.97 | 1.17 | V             |
| CS/FB Threshold Voltage3 <sup>(1)</sup> | VCS/FB3                  | -  | 0.7  | 0.9  | 1.1  | V             |
| <b>SOFT START SECTION</b>               |                          |  |      |      |      |               |
| Soft Start Current                      | ISS                      | $V_{\text{pin3}} = \text{GND}$                             | 9    | 12   | 15   | $\mu\text{A}$ |
| Soft Start Limit Voltage <sup>(2)</sup> | VSL                      | $I_{SS} = 1\mu\text{A}$                                    | 1.2  | 1.5  | 1.8  | V             |
| <b>PROTECTION SECTION</b>               |                          |  |      |      |      |               |
| Latch Voltage                           | VLATCH                   | -  | 2.25 | 2.5  | 2.75 | V             |
| Over Voltage Protection                 | VOVP                     | -  | 18   | 19   | 20   | V             |
| <b>UVLO SECTION</b>                     |                          |  |      |      |      |               |
| Start Threshold Voltage                 | $V_{\text{tH}}$          | -  | 11   | 12   | 13   | V             |
| Minimum Operating Voltage               | $V_{\text{tL}}$          | -  | 7    | 8    | 9    | V             |
| <b>TOTAL CURRENT SECTION</b>            |                          |  |      |      |      |               |
| Operating Supply Current                | IOP                      | -  | -    | 3    | 4    | mA            |
| <b>OUTPUT SECTION</b>                   |                          |  |      |      |      |               |
| Low Output Voltage                      | VOL                      | $T_a = 25^{\circ}\text{C}$ , $I_O = 100\text{mA}$          | -    | 2    | 2.5  | V             |
| High Output Voltage                     | VOH                      | $T_a = 25^{\circ}\text{C}$ , $I_O = -100\text{mA}$         | 11.5 | 12   | 14   | V             |
| Rising Time <sup>(1)</sup>              | $T_r$                    | $T_a = 25^{\circ}\text{C}$ , $C_l = 1\text{nF}$            | -    | 45   | 150  | ns            |
| Falling Time <sup>(1)</sup>             | $T_f$                    | $T_a = 25^{\circ}\text{C}$ , $C_l = 1\text{nF}$            | -    | 35   | 150  | ns            |
| <b>START UP SECTION</b>                 |                          |  |      |      |      |               |
| VSTR Start-up Current                   | Istr                     | $V_{\text{str}} = 30\text{V}$ , $T_a = 25^{\circ}\text{C}$ | 0.5  | 1    | 1.5  | mA            |

### Note:

1. These parameters, although guaranteed, are not 100% tested in production.
2. It is recommended to connect  $1\text{M}\Omega$  resistor between the Latch/SS pin and GND to prevent abnormal operation of the latch protection by noise coupling.

## Typical Performance Characteristics

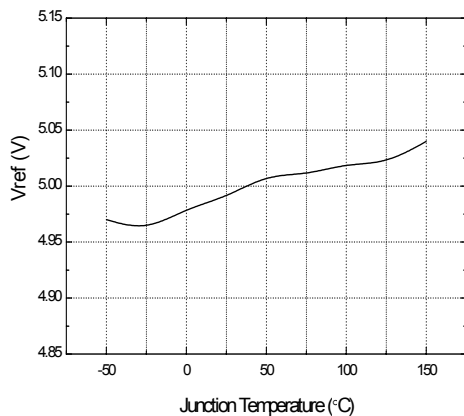

Figure 1. Trimmed Reference Voltage

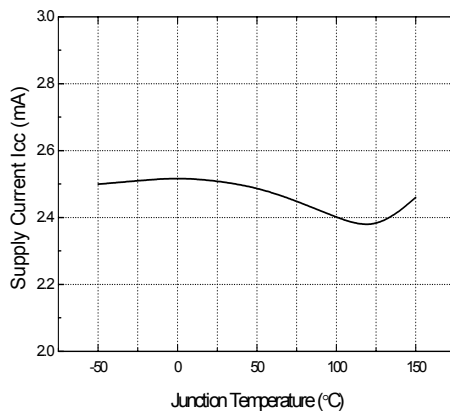

Figure 2. Supply Current

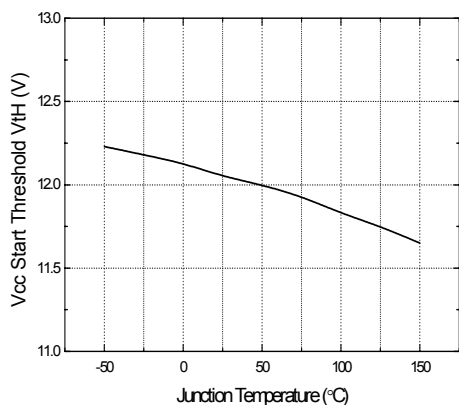

Figure 3. Vcc Start Threshold Voltage

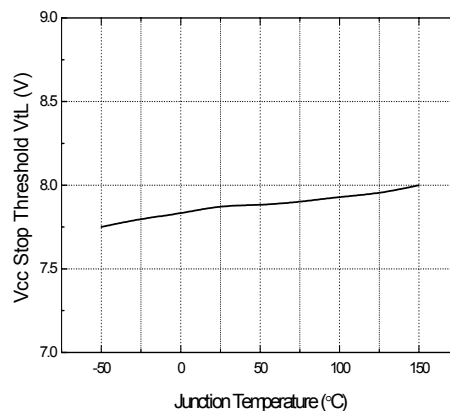

Figure 4. Vcc Stop Threshold Voltage

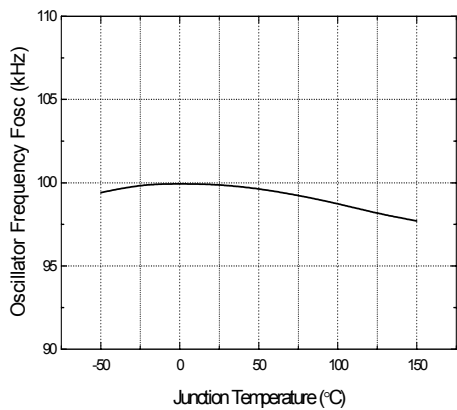

Figure 5. Oscillator Frequency

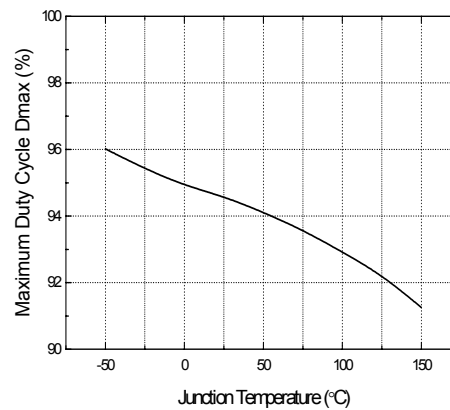

Figure 6. Maximum Duty Cycle

Typical Performance Characteristics (Continued)

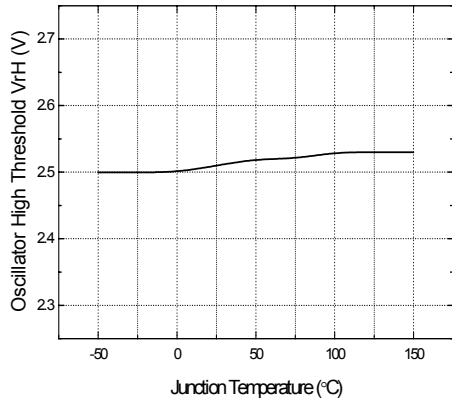

Figure 7. Oscillator High Threshold Voltage

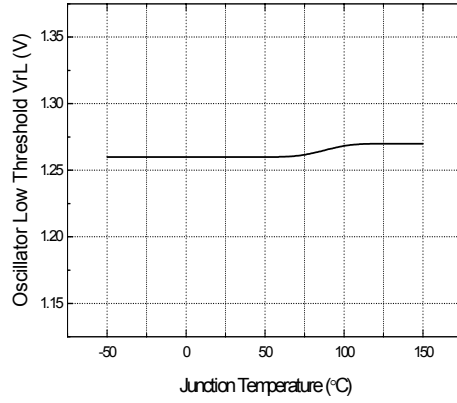

Figure 8. Oscillator Low Threshold Voltage

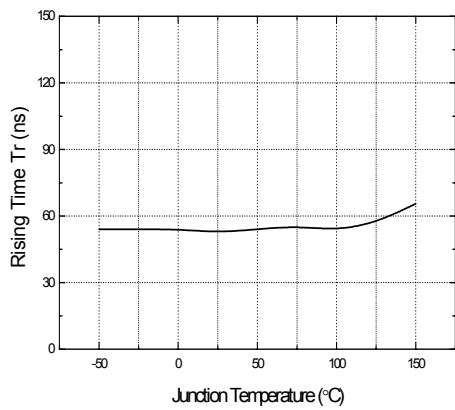

Figure 9. Output Rising Time

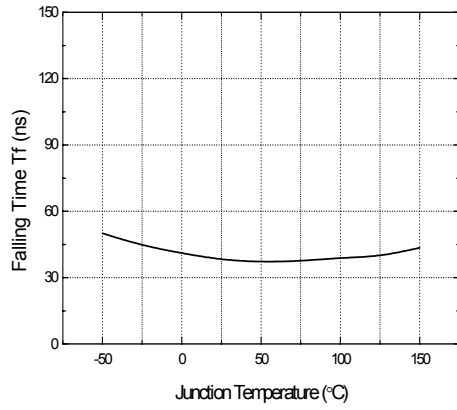

Figure 10. Output Falling Time

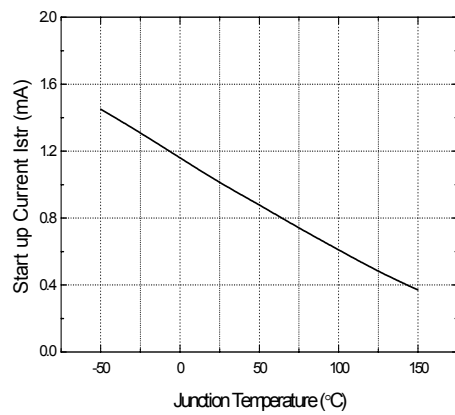

Figure 11. Start-up Current

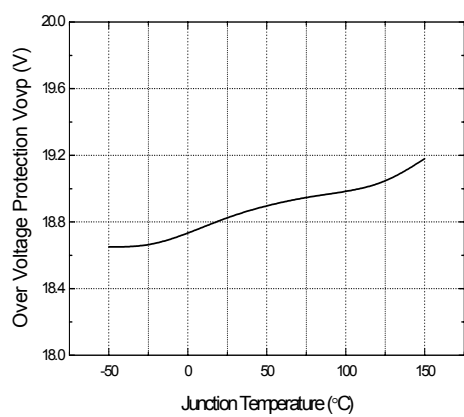

Figure 12. Over Voltage Protection Level

Typical Performance Characteristics (Continued)

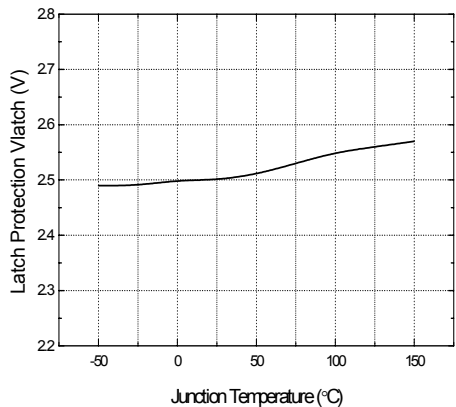

Figure 13. Latch Protection Voltage

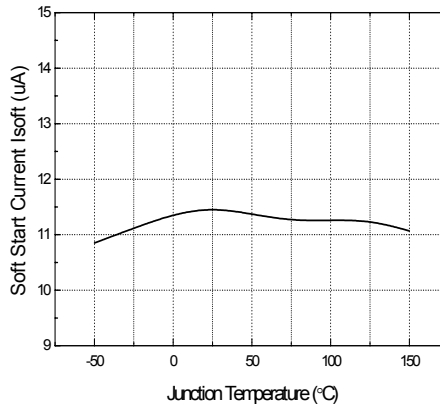

Figure 14. Soft Start Current

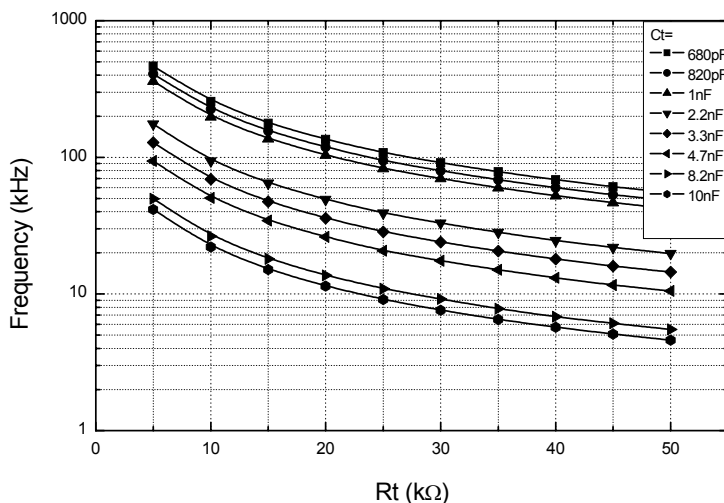
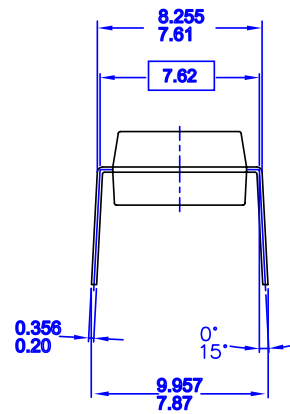
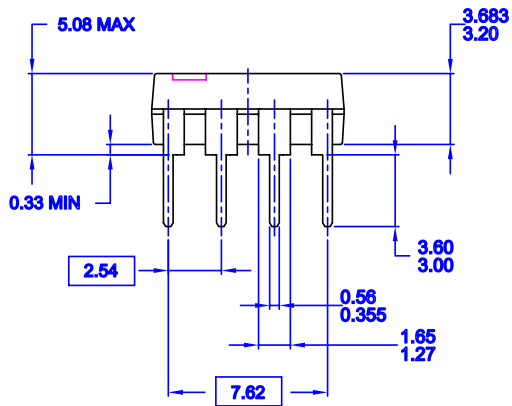
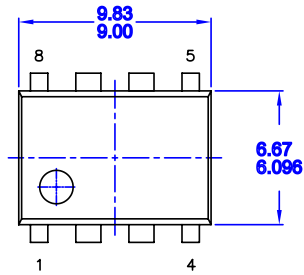

Figure 15. Oscillator Frequency Characteristic



# Mechanical Dimensions

## 8DIP



- NOTES: UNLESS OTHERWISE SPECIFIED
- A) THIS PACKAGE CONFORMS TO JEDEC MS-001 VARIATION BA
  - B) ALL DIMENSIONS ARE IN MILLIMETERS.
  - C) DIMENSIONS ARE EXCLUSIVE OF BURRS, MOLD FLASH, AND TIE BAR EXTRUSIONS.
  - D) DIMENSIONS AND TOLERANCES PER ASME Y14.5M-1994

MKT-N08FrevB

Mechanical Dimensions (Unit: mm) (Continued)

Package

8-SOP

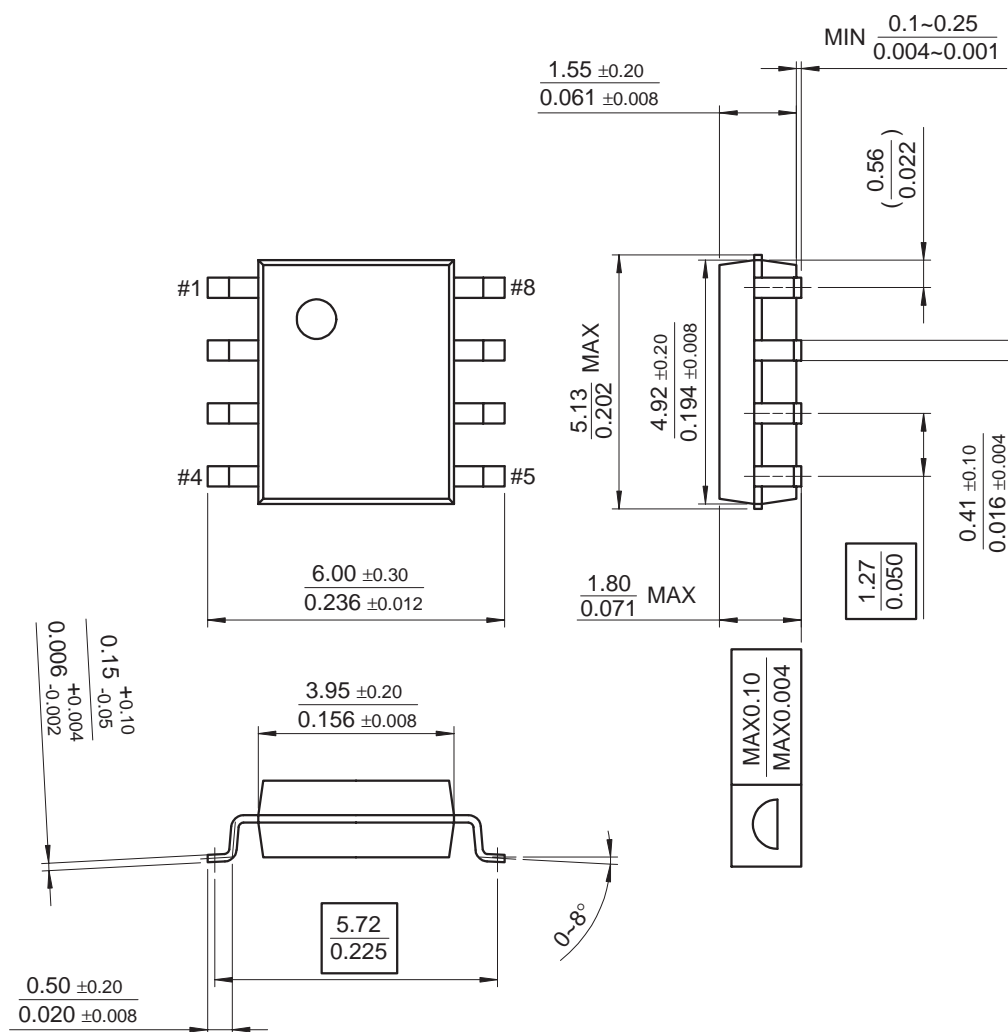

**Mechanical Dimensions (Unit: mm)** (Continued)

**Package**

**10-SSOP-225**

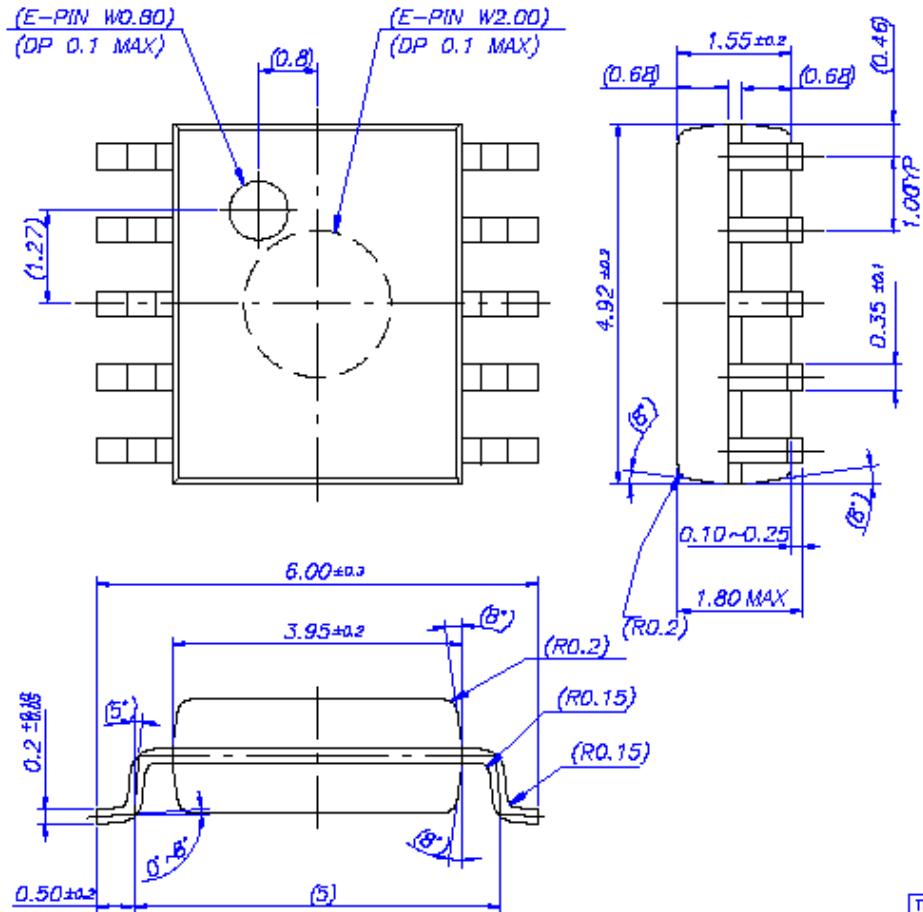

≡

---

## Ordering Information

| Device   | Package | Operating Temp. |
|----------|---------|-----------------|
| FAN7601N | 8-DIP   | -25°C ~ 125°C   |
| FAN7601M | 8-SOP   |                 |
| FAN7601G | 10-SSOP |                 |

**DISCLAIMER**

FAIRCHILD SEMICONDUCTOR RESERVES THE RIGHT TO MAKE CHANGES WITHOUT FURTHER NOTICE TO ANY PRODUCTS HEREIN TO IMPROVE RELIABILITY, FUNCTION OR DESIGN. FAIRCHILD DOES NOT ASSUME ANY LIABILITY ARISING OUT OF THE APPLICATION OR USE OF ANY PRODUCT OR CIRCUIT DESCRIBED HEREIN; NEITHER DOES IT CONVEY ANY LICENSE UNDER ITS PATENT RIGHTS, NOR THE RIGHTS OF OTHERS.

**LIFE SUPPORT POLICY**

FAIRCHILD'S PRODUCTS ARE NOT AUTHORIZED FOR USE AS CRITICAL COMPONENTS IN LIFE SUPPORT DEVICES OR SYSTEMS WITHOUT THE EXPRESS WRITTEN APPROVAL OF THE PRESIDENT OF FAIRCHILD SEMICONDUCTOR CORPORATION. As used herein:

1. Life support devices or systems are devices or systems which, (a) are intended for surgical implant into the body, or (b) support or sustain life, and (c) whose failure to perform when properly used in accordance with instructions for use provided in the labeling, can be reasonably expected to result in a significant injury of the user.
2. A critical component in any component of a life support device or system whose failure to perform can be reasonably expected to cause the failure of the life support device or system, or to affect its safety or effectiveness.

ON Semiconductor and  are trademarks of Semiconductor Components Industries, LLC dba ON Semiconductor or its subsidiaries in the United States and/or other countries. ON Semiconductor owns the rights to a number of patents, trademarks, copyrights, trade secrets, and other intellectual property. A listing of ON Semiconductor's product/patent coverage may be accessed at [www.onsemi.com/site/pdf/Patent-Marking.pdf](http://www.onsemi.com/site/pdf/Patent-Marking.pdf). ON Semiconductor reserves the right to make changes without further notice to any products herein. ON Semiconductor makes no warranty, representation or guarantee regarding the suitability of its products for any particular purpose, nor does ON Semiconductor assume any liability arising out of the application or use of any product or circuit, and specifically disclaims any and all liability, including without limitation special, consequential or incidental damages. Buyer is responsible for its products and applications using ON Semiconductor products, including compliance with all laws, regulations and safety requirements or standards, regardless of any support or applications information provided by ON Semiconductor. "Typical" parameters which may be provided in ON Semiconductor data sheets and/or specifications can and do vary in different applications and actual performance may vary over time. All operating parameters, including "Typicals" must be validated for each customer application by customer's technical experts. ON Semiconductor does not convey any license under its patent rights nor the rights of others. ON Semiconductor products are not designed, intended, or authorized for use as a critical component in life support systems or any FDA Class 3 medical devices or medical devices with a same or similar classification in a foreign jurisdiction or any devices intended for implantation in the human body. Should Buyer purchase or use ON Semiconductor products for any such unintended or unauthorized application, Buyer shall indemnify and hold ON Semiconductor and its officers, employees, subsidiaries, affiliates, and distributors harmless against all claims, costs, damages, and expenses, and reasonable attorney fees arising out of, directly or indirectly, any claim of personal injury or death associated with such unintended or unauthorized use, even if such claim alleges that ON Semiconductor was negligent regarding the design or manufacture of the part. ON Semiconductor is an Equal Opportunity/Affirmative Action Employer. This literature is subject to all applicable copyright laws and is not for resale in any manner.

## PUBLICATION ORDERING INFORMATION

### LITERATURE FULFILLMENT:

Literature Distribution Center for ON Semiconductor  
19521 E. 32nd Pkwy, Aurora, Colorado 80011 USA  
**Phone:** 303-675-2175 or 800-344-3860 Toll Free USA/Canada  
**Fax:** 303-675-2176 or 800-344-3867 Toll Free USA/Canada  
**Email:** [orderlit@onsemi.com](mailto:orderlit@onsemi.com)

**N. American Technical Support:** 800-282-9855 Toll Free  
USA/Canada  
**Europe, Middle East and Africa Technical Support:**  
Phone: 421 33 790 2910  
**Japan Customer Focus Center**  
Phone: 81-3-5817-1050

**ON Semiconductor Website:** [www.onsemi.com](http://www.onsemi.com)  
**Order Literature:** <http://www.onsemi.com/orderlit>  
For additional information, please contact your local  
Sales Representative