



Is Now Part of



**ON Semiconductor®**

To learn more about ON Semiconductor, please visit our website at  
[www.onsemi.com](http://www.onsemi.com)

Please note: As part of the Fairchild Semiconductor integration, some of the Fairchild orderable part numbers will need to change in order to meet ON Semiconductor's system requirements. Since the ON Semiconductor product management systems do not have the ability to manage part nomenclature that utilizes an underscore (\_), the underscore (\_) in the Fairchild part numbers will be changed to a dash (-). This document may contain device numbers with an underscore (\_). Please check the ON Semiconductor website to verify the updated device numbers. The most current and up-to-date ordering information can be found at [www.onsemi.com](http://www.onsemi.com). Please email any questions regarding the system integration to [Fairchild\\_questions@onsemi.com](mailto:Fairchild_questions@onsemi.com).

ON Semiconductor and the ON Semiconductor logo are trademarks of Semiconductor Components Industries, LLC dba ON Semiconductor or its subsidiaries in the United States and/or other countries. ON Semiconductor owns the rights to a number of patents, trademarks, copyrights, trade secrets, and other intellectual property. A listing of ON Semiconductor's product/patent coverage may be accessed at [www.onsemi.com/site/pdf/Patent-Marking.pdf](http://www.onsemi.com/site/pdf/Patent-Marking.pdf). ON Semiconductor reserves the right to make changes without further notice to any products herein. ON Semiconductor makes no warranty, representation or guarantee regarding the suitability of its products for any particular purpose, nor does ON Semiconductor assume any liability arising out of the application or use of any product or circuit, and specifically disclaims any and all liability, including without limitation special, consequential or incidental damages. Buyer is responsible for its products and applications using ON Semiconductor products, including compliance with all laws, regulations and safety requirements or standards, regardless of any support or applications information provided by ON Semiconductor. "Typical" parameters which may be provided in ON Semiconductor data sheets and/or specifications can and do vary in different applications and actual performance may vary over time. All operating parameters, including "Typicals" must be validated for each customer application by customer's technical experts. ON Semiconductor does not convey any license under its patent rights nor the rights of others. ON Semiconductor products are not designed, intended, or authorized for use as a critical component in life support systems or any FDA Class 3 medical devices or medical devices with a same or similar classification in a foreign jurisdiction or any devices intended for implantation in the human body. Should Buyer purchase or use ON Semiconductor products for any such unintended or unauthorized application, Buyer shall indemnify and hold ON Semiconductor and its officers, employees, subsidiaries, affiliates, and distributors harmless against all claims, costs, damages, and expenses, and reasonable attorney fees arising out of, directly or indirectly, any claim of personal injury or death associated with such unintended or unauthorized use, even if such claim alleges that ON Semiconductor was negligent regarding the design or manufacture of the part. ON Semiconductor is an Equal Opportunity/Affirmative Action Employer. This literature is subject to all applicable copyright laws and is not for resale in any manner.

# FDT439N

## N-Channel 2.5V Specified Enhancement Mode Field Effect Transistor

### General Description

This N-Channel Enhancement mode field effect transistor is produced using Fairchild Semiconductor's proprietary, high cell density, DMOS technology. This very high density process is especially tailored to minimize on-state resistance, and provide superior switching performance. These products are well suited to low voltage, low current applications such as notebook computer power management, battery powered circuits, and DC motor control.

### Features

- 6.3 A, 30 V.  $R_{DS(on)} = 0.045 \Omega @ V_{GS} = 4.5 V$   
 $R_{DS(on)} = 0.058 \Omega @ V_{GS} = 2.5 V$
- Fast switching speed.
- High power and current handling capability in a widely used surface mount package.

### Applications

- DC/DC converter
- Load switch
- Motor driving

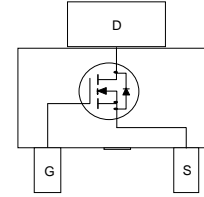
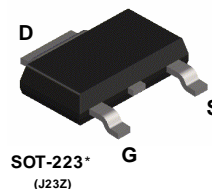
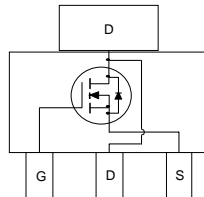
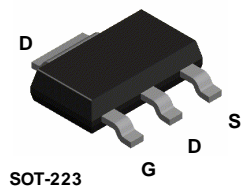

### Absolute Maximum Ratings $T_A = 25^\circ\text{C}$ unless otherwise noted

| Symbol         | Parameter  | FDT439N     | Units            |
|----------------|--|-------------|------------------|
| $V_{DSS}$      | Drain-Source Voltage   | 30          | V                |
| $V_{GSS}$      | Gate-Source Voltage  | $\pm 8$     | V                |
| $I_D$          | Drain Current - Continuous (Note 1a)<br>- Pulsed                           | 6.3         | A                |
|                |  | 20          |                  |
| $P_D$          | Power Dissipation for Single Operation (Note 1a)<br>(Note 1b)<br>(Note 1c) | 3           | W                |
|                |  | 1.3         |                  |
|                |  | 1.1         |                  |
| $T_J, T_{sig}$ | Operating and Storage Junction Temperature Range                           | -55 to +150 | $^\circ\text{C}$ |

### Thermal Characteristics

|                 |   |    |                    |
|-----------------|---|----|--------------------|
| $R_{\theta JA}$ | Thermal Resistance, Junction-to-Ambient (Note 1a) | 42 | $^\circ\text{C/W}$ |
| $R_{\theta JC}$ | Thermal Resistance, Junction-to-Case (Note 1)     | 12 | $^\circ\text{C/W}$ |

### Package Marking and Ordering Information

| Device Marking | Device  | Reel Size | Tape Width | Quantity   |
|----------------|---------|-----------|------------|------------|
| FDT439N        | FDT439N | 13"       | 12mm       | 2500 units |

## Electrical Characteristics

$T_A = 25^\circ\text{C}$  unless otherwise noted

| Symbol | Parameter | Test Conditions | Min | Typ | Max | Units |
|--------|-----------|-----------------|-----|-----|-----|-------|
|--------|-----------|-----------------|-----|-----|-----|-------|

### Off Characteristics

|                                      |   |   |    |    |      |                      |
|--------------------------------------|---|---|----|----|------|----------------------|
| $BV_{DSS}$                           | Drain-Source Breakdown Voltage            | $V_{GS} = 0\text{ V}, I_D = 250\ \mu\text{A}$               | 30 |    |      | V                    |
| $\frac{\Delta BV_{DSS}}{\Delta T_J}$ | Breakdown Voltage Temperature Coefficient | $I_D = 250\ \mu\text{A}$ , Referenced to $25^\circ\text{C}$ |    | 40 |      | mV/ $^\circ\text{C}$ |
| $I_{DSS}$                            | Zero Gate Voltage Drain Current           | $V_{DS} = 24\text{ V}, V_{GS} = 0\text{ V}$                 |    |    | 1    | $\mu\text{A}$        |
| $I_{GSSF}$                           | Gate-Body Leakage Current, Forward        | $V_{GS} = 8\text{ V}, V_{DS} = 0\text{ V}$                  |    |    | 100  | nA                   |
| $I_{GSSR}$                           | Gate-Body Leakage Current, Reverse        | $V_{GS} = -8\text{ V}, V_{DS} = 0\text{ V}$                 |    |    | -100 | nA                   |

### On Characteristics (Note 2)

|  |  |  |     |                         |                         |                      |
|--|--|--|-----|-------------------------|-------------------------|----------------------|
| $V_{GS(th)}$                           | Gate Threshold Voltage                         | $V_{DS} = V_{GS}, I_D = 250\ \mu\text{A}$  | 0.4 | 0.67                    | 1                       | V                    |
| $\frac{\Delta V_{GS(th)}}{\Delta T_J}$ | Gate Threshold Voltage Temperature Coefficient | $I_D = 250\ \mu\text{A}$ , Referenced to $25^\circ\text{C}$  |     | -2.2                    |                         | mV/ $^\circ\text{C}$ |
| $R_{DS(on)}$                           | Static Drain-Source On-Resistance              | $V_{GS} = 4.5\text{ V}, I_D = 6.3\text{ A}$<br>$V_{GS} = 4.5\text{ V}, I_D = 6.3\text{ A}, T_J = 125^\circ\text{C}$<br>$V_{GS} = 2.5\text{ V}, I_D = 5.5\text{ A}$ |     | 0.038<br>0.055<br>0.048 | 0.045<br>0.072<br>0.058 | $\Omega$             |
| $I_{D(on)}$                            | On-State Drain Current                         | $V_{GS} = 4.5\text{ V}, V_{DS} = 5\text{ V}$   | 10  |                         |                         | A                    |
| $g_{FS}$                               | Forward Transconductance                       | $V_{DS} = 5\text{ V}, I_D = 6.3\text{ A}$  |     | 17                      |                         | S                    |

### Dynamic Characteristics

|           |                              |  |  |     |  |    |
|-----------|------------------------------|--|--|-----|--|----|
| $C_{iss}$ | Input Capacitance            | $V_{DS} = 15\text{ V}, V_{GS} = 0\text{ V},$<br>$f = 1.0\text{ MHz}$ |  | 500 |  | pF |
| $C_{oss}$ | Output Capacitance           |  |  | 185 |  | pF |
| $C_{rss}$ | Reverse Transfer Capacitance |  |  | 43  |  | pF |

### Switching Characteristics (Note 2)

|              |                     |   |  |      |    |    |
|--------------|---------------------|---|--|------|----|----|
| $t_{d(on)}$  | Turn-On Delay Time  | $V_{DD} = 15\text{ V}, I_D = 1\text{ A},$<br>$V_{GS} = 4.5\text{ V}, R_{GEN} = 6\ \Omega$ |  | 6    | 12 | ns |
| $t_r$        | Turn-On Rise Time   |   |  | 10   | 18 | ns |
| $t_{d(off)}$ | Turn-Off Delay Time |   |  | 30   | 48 | ns |
| $t_f$        | Turn-Off Fall Time  |   |  | 10   | 18 | ns |
| $Q_g$        | Total Gate Charge   | $V_{DS} = 15\text{ V}, I_D = 6.3\text{ A},$<br>$V_{GS} = 4.5\text{ V},$                   |  | 10.7 | 15 | nC |
| $Q_{gs}$     | Gate-Source Charge  |   |  | 0.9  |    | nC |
| $Q_{gd}$     | Gate-Drain Charge   |   |  | 3.7  |    | nC |

### Drain-Source Diode Characteristics and Maximum Ratings

|          |   |  |  |     |     |   |
|----------|---|--|--|-----|-----|---|
| $I_S$    | Maximum Continuous Drain-Source Diode Forward Current |  |  | 2.5 | A   |   |
| $V_{SD}$ | Drain-Source Diode Forward Voltage                    | $V_{GS} = 0\text{ V}, I_S = 2.5\text{ A}$ (Note 2) |  | 0.8 | 1.2 | V |

#### Notes:

- $R_{\theta JA}$  is the sum of the junction-to-case and case-to-ambient thermal resistance where the case thermal reference is defined as the solder mounting surface of the drain pins.  
 $R_{\theta JC}$  is guaranteed by design while  $R_{\theta CA}$  is determined by the user's board design.

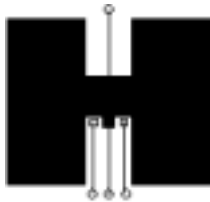

a)  $42^\circ\text{C/W}$  when mounted on a  $1\text{ in}^2$  pad of 2 oz. copper.



b)  $95^\circ\text{C/W}$  when mounted on a  $0.066\text{ in}^2$  pad of 2 oz. copper.



c)  $110^\circ\text{C/W}$  when mounted on a minimum mounting pad.

Scale 1 : 1 on letter size paper

- Pulse Test: Pulse Width  $\leq 300\ \mu\text{s}$ , Duty Cycle  $\leq 2.0\%$

Typical Characteristics

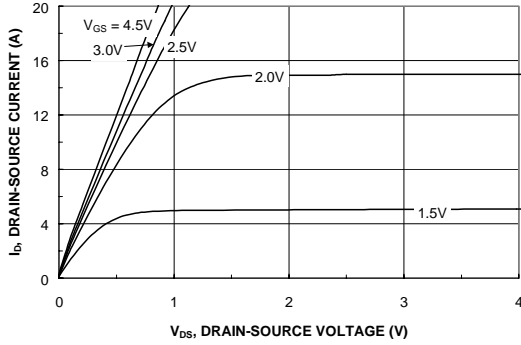

Figure 1. On-Region Characteristics.

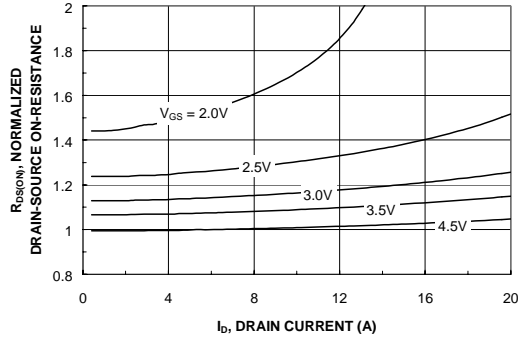

Figure 2. On-Resistance Variation with Drain Current and Gate Voltage.

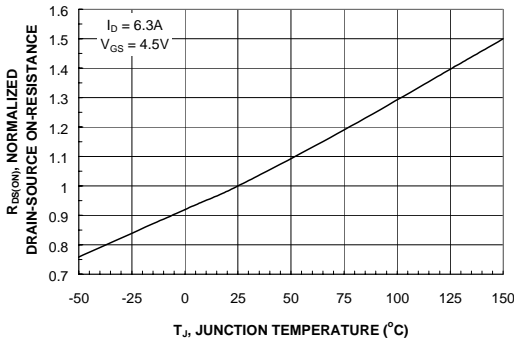

Figure 3. On-Resistance Variation with Temperature.

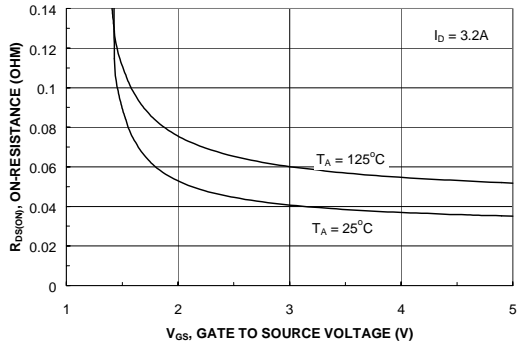

Figure 4. On-Resistance Variation with Gate-To-Source Voltage.

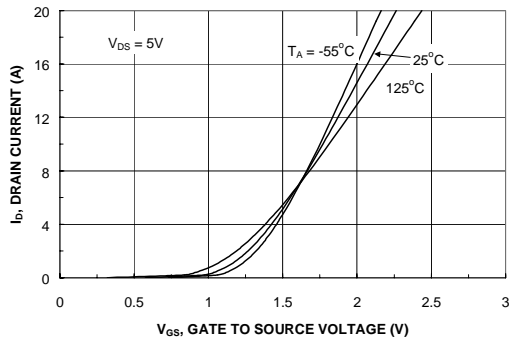

Figure 5. Transfer Characteristics.

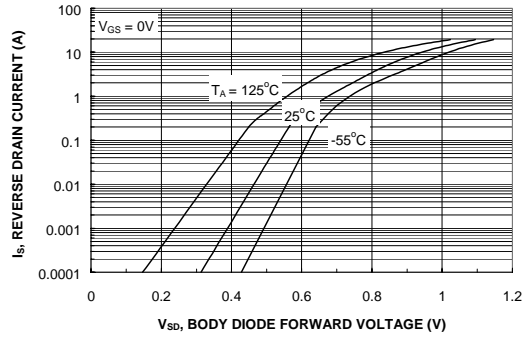
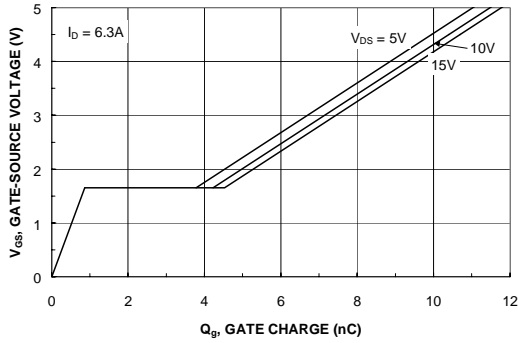
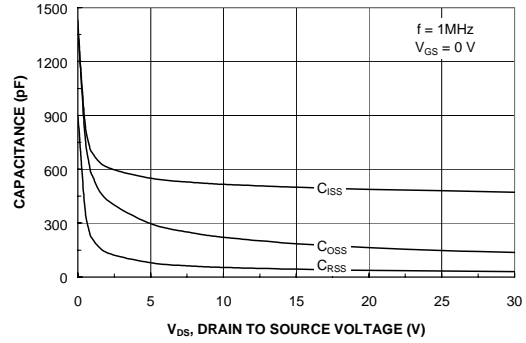

Figure 6. Body Diode Forward Voltage Variation with Source Current and Temperature.

**Typical Characteristics** (continued)



**Figure 7. Gate-Charge Characteristics.**



**Figure 8. Capacitance Characteristics.**

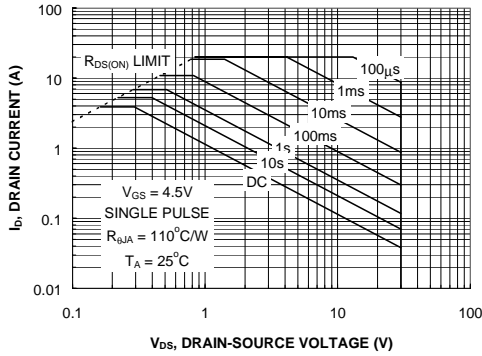

**Figure 9. Maximum Safe Operating Area.**

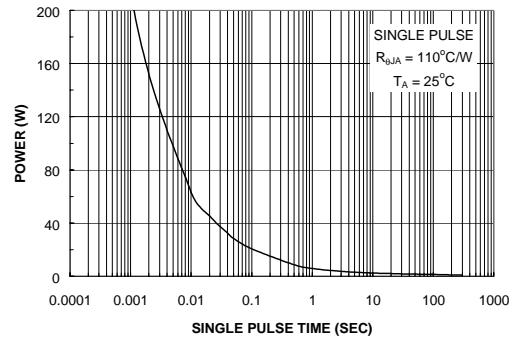

**Figure 10. Single Pulse Maximum Power Dissipation.**

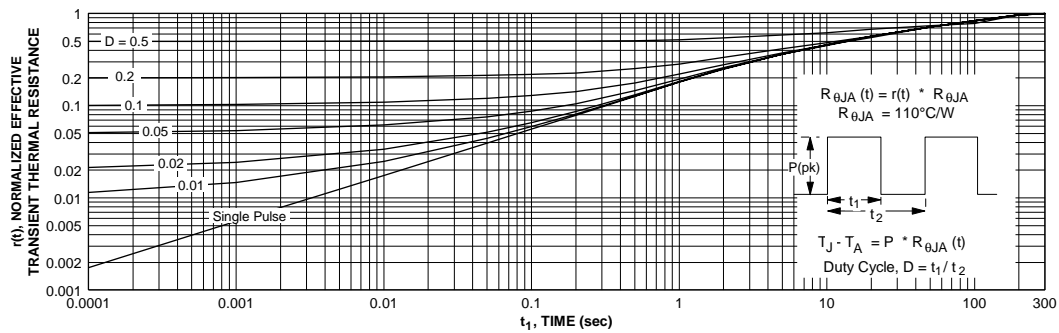

**Figure 11. Transient Thermal Response Curve.**

Thermal characterization performed using the conditions described in Note 1. Transient thermal response will change depending on the circuit board design.



LAND PATTERN RECOMMENDATION



- NOTES: UNLESS OTHERWISE SPECIFIED  
 A) DRAWING BASED ON JEDEC REGISTRATION TO-261C, VARIATION AA.  
 B) ALL DIMENSIONS ARE IN MILLIMETERS.  
 C) DIMENSIONS DO NOT INCLUDE BURRS OR MOLD FLASH. MOLD FLASH OR BURRS DOES NOT EXCEED 0.10MM.  
 D) DIMENSIONING AND TOLERANCING PER ASME Y14.5M-2009.  
 E) LANDPATTERN NAME: SOT230P700X180-4BN  
 F) DRAWING FILENAME: MKT-MA04AREV3

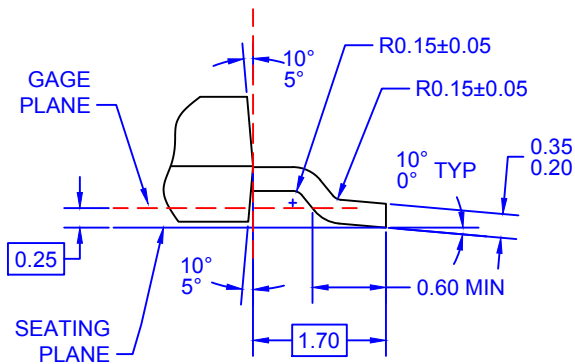

DETAIL A  
 SCALE: 2:1



ON Semiconductor and  are trademarks of Semiconductor Components Industries, LLC dba ON Semiconductor or its subsidiaries in the United States and/or other countries. ON Semiconductor owns the rights to a number of patents, trademarks, copyrights, trade secrets, and other intellectual property. A listing of ON Semiconductor's product/patent coverage may be accessed at [www.onsemi.com/site/pdf/Patent-Marking.pdf](http://www.onsemi.com/site/pdf/Patent-Marking.pdf). ON Semiconductor reserves the right to make changes without further notice to any products herein. ON Semiconductor makes no warranty, representation or guarantee regarding the suitability of its products for any particular purpose, nor does ON Semiconductor assume any liability arising out of the application or use of any product or circuit, and specifically disclaims any and all liability, including without limitation special, consequential or incidental damages. Buyer is responsible for its products and applications using ON Semiconductor products, including compliance with all laws, regulations and safety requirements or standards, regardless of any support or applications information provided by ON Semiconductor. "Typical" parameters which may be provided in ON Semiconductor data sheets and/or specifications can and do vary in different applications and actual performance may vary over time. All operating parameters, including "Typicals" must be validated for each customer application by customer's technical experts. ON Semiconductor does not convey any license under its patent rights nor the rights of others. ON Semiconductor products are not designed, intended, or authorized for use as a critical component in life support systems or any FDA Class 3 medical devices or medical devices with a same or similar classification in a foreign jurisdiction or any devices intended for implantation in the human body. Should Buyer purchase or use ON Semiconductor products for any such unintended or unauthorized application, Buyer shall indemnify and hold ON Semiconductor and its officers, employees, subsidiaries, affiliates, and distributors harmless against all claims, costs, damages, and expenses, and reasonable attorney fees arising out of, directly or indirectly, any claim of personal injury or death associated with such unintended or unauthorized use, even if such claim alleges that ON Semiconductor was negligent regarding the design or manufacture of the part. ON Semiconductor is an Equal Opportunity/Affirmative Action Employer. This literature is subject to all applicable copyright laws and is not for resale in any manner.

## PUBLICATION ORDERING INFORMATION

### LITERATURE FULFILLMENT:

Literature Distribution Center for ON Semiconductor  
19521 E. 32nd Pkwy, Aurora, Colorado 80011 USA  
**Phone:** 303-675-2175 or 800-344-3860 Toll Free USA/Canada  
**Fax:** 303-675-2176 or 800-344-3867 Toll Free USA/Canada  
**Email:** [orderlit@onsemi.com](mailto:orderlit@onsemi.com)

**N. American Technical Support:** 800-282-9855 Toll Free  
USA/Canada  
**Europe, Middle East and Africa Technical Support:**  
Phone: 421 33 790 2910  
**Japan Customer Focus Center**  
Phone: 81-3-5817-1050

**ON Semiconductor Website:** [www.onsemi.com](http://www.onsemi.com)  
**Order Literature:** <http://www.onsemi.com/orderlit>  
For additional information, please contact your local  
Sales Representative