

# STEALTH Diode

## 30 A, 300 V

### FFH30US30DN

#### Description

The FFH30US30DN is a STEALTH™ diode optimized for low loss performance in output rectification. The STEALTH family exhibits low reverse recovery current ( $I_{RM(REC)}$ ), low  $V_F$  and soft recovery under typical operating conditions.

This device is intended for use as an output rectification diode in Telecom power supplies and other power switching applications. Lower  $V_F$  and  $I_{RM(REC)}$  reduces diode losses.

Formerly developmental type TA49449.

#### Features

- Soft Recovery  $t_b/t_a > 0.45$
- Fast Recovery  $t_{rr} < 50$  ns
- High Operating Temperature  $175^\circ\text{C}$
- Reverse Voltage 300 V
- Avalanche Energy Rating 20 mJ
- This is a Pb-Free Device

#### Applications

- Switch Mode Power Supplies
- Power Factor Correction
- Uninterruptable Power Supplies
- Motor Drives
- Welders



**ON Semiconductor®**

[www.onsemi.com](http://www.onsemi.com)

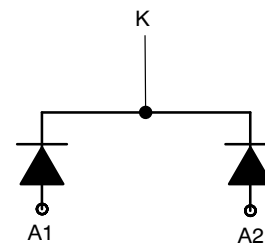
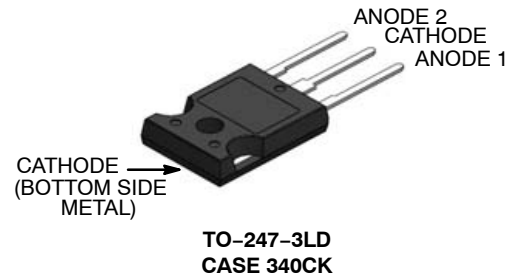

#### MARKING DIAGRAM

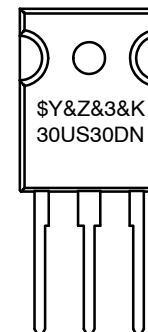

\$Y	= ON Semiconductor Logo
&Z	= Assembly Plant Code
&3	= Numeric Date Code
&K	= Lot Code
30US30DN	= Specific Device Code

#### ORDERING INFORMATION

See detailed ordering and shipping information on page 2 of this data sheet.

# FFH30US30DN

## DEVICE MAXIMUM RATINGS (per leg) ( $T_C = 25^\circ\text{C}$ unless otherwise noted)

Rating	Symbol	Value	Unit
Repetitive Peak Reverse Voltage	$V_{RRM}$	300	V
Working Peak Reverse Voltage	$V_{RWM}$	300	V
DC Blocking Voltage	$V_R$	300	V
Average Rectified Forward Current ( $T_C = 160^\circ\text{C}$ )	$I_{F(AV)}$	30	A
Total Device Current (Both Legs)		60	
Repetitive Peak Surge Current (20 kHz Square Wave)	$I_{FRM}$	70	A
Non-repetitive Peak Surge Current (Halfwave 1 Phase 60 Hz)	$I_{FSM}$	325	A
Power Dissipation	$P_D$	230	W
Avalanche Energy (1 A, 40 mH)	$E_{AVL}$	20	mJ
Operating and Storage Temperature Range	$T_J, T_{STG}$	-55 to 175	$^\circ\text{C}$
Maximum Temperature for Soldering Leads at 0.063in (1.6 mm) from Case for 10 s Package Body for 10 s, See Application Note AN-7528	$T_L$ $T_{PKG}$	300 260	$^\circ\text{C}$ $^\circ\text{C}$

Stresses exceeding those listed in the Maximum Ratings table may damage the device. If any of these limits are exceeded, device functionality should not be assumed, damage may occur and reliability may be affected.

## THERMAL CHARACTERISTICS ( $T_C = 25^\circ\text{C}$ unless otherwise noted)

Parameter	Symbol	Max	Unit
Thermal Resistance, Junction to Case	$R_{\theta JC}$	0.65	$^\circ\text{C}/\text{W}$
Thermal Resistance, Junction to Ambient	$R_{\theta JA}$	30	$^\circ\text{C}/\text{W}$

## PACKAGE MARKING AND ORDERING INFORMATION

Device	Device Marking	Package	Tape Width	Quantity
FFH30US30DN	30US30DN	TO-247-3LD	N/A	30

# FFH30US30DN

## ELECTRICAL CHARACTERISTICS ( $T_J = 25^\circ\text{C}$ unless otherwise noted)

Parameter	Symbol	Test Condition	Min	Typ	Max	Unit
-----------	--------	----------------	-----	-----	-----	------

### OFF STATE CHARACTERISTICS

Instantaneous Reverse Current	$I_R$	$V_R = 300\text{ V}$	$T_C = 25^\circ\text{C}$	-	-	100	$\mu\text{A}$
			$T_C = 125^\circ\text{C}$	-	-	1	$\text{mA}$

### ON STATE CHARACTERISTICS

Instantaneous Forward Voltage	$V_F$	$I_F = 30\text{ A}$	$T_C = 25^\circ\text{C}$	-	0.93	1.0	V
			$T_C = 125^\circ\text{C}$	-	0.8	0.87	

### DYNAMIC CHARACTERISTICS

Junction Capacitance	$C_J$	$V_R = 10\text{ V}, I_F = 0\text{ A}$	-	410	-	$\text{pF}$
----------------------	-------	---------------------------------------	---	-----	---	-------------

### SWITCHING CHARACTERISTICS

Reverse Recovery Time	$t_{rr}$	$I_F = 1\text{ A}, di_F/dt = 100\text{ A}/\mu\text{s}, V_R = 15\text{ V}$	-	29	50	ns
			$I_F = 30\text{ A}, di_F/dt = 100\text{ A}/\mu\text{s}, V_R = 15\text{ V}$	-	32	
Reverse Recovery Time	$t_{rr}$	$I_F = 30\text{ A}, di_F/dt = 200\text{ A}/\mu\text{s}, V_R = 195\text{ V}, T_C = 25^\circ\text{C}$	-	46	-	ns
Maximum Reverse Recovery Current	$I_{RM(REC)}$		-	5.3	-	A
Reverse Recovered Charge	$Q_{RR}$		-	140	-	nC
Reverse Recovery Time	$t_{rr}$		-	77	-	ns
Softness Factor ( $t_b/t_a$ )	S	$I_F = 30\text{ A}, di_F/dt = 200\text{ A}/\mu\text{s}, V_R = 195\text{ V}, T_C = 125^\circ\text{C}$	-	0.45	-	-
Maximum Reverse Recovery Current	$I_{RM(REC)}$		-	9	-	A
Reverse Recovered Charge	$Q_{RR}$		-	400	-	nC
Reverse Recovery Time	$t_{rr}$		-	54	-	ns
Softness Factor ( $t_b/t_a$ )	S	$I_F = 30\text{ A}, di_F/dt = 1000\text{ A}/\mu\text{s}, V_R = 195\text{ V}, T_C = 125^\circ\text{C}$	-	0.49	-	-
Maximum Reverse Recovery Current	$I_{RM(REC)}$		-	32	-	A
Reverse Recovered Charge	$Q_{RR}$		-	930	-	nC

Product parametric performance is indicated in the Electrical Characteristics for the listed test conditions, unless otherwise noted. Product performance may not be indicated by the Electrical Characteristics if operated under different conditions.

# FFH30US30DN

## TYPICAL PERFORMANCE CURVES (per leg)

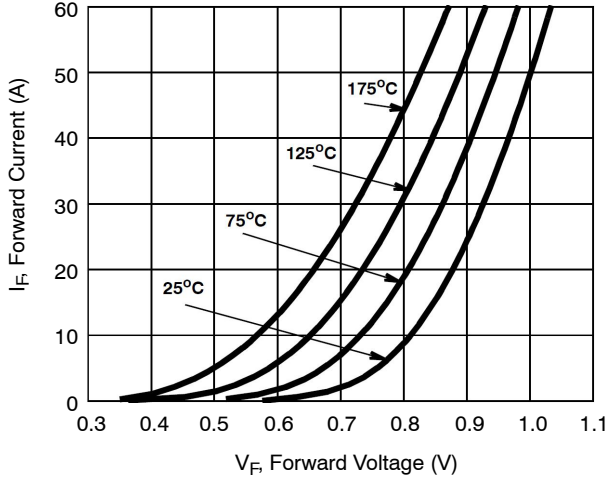

Figure 1. Forward Current vs. Forward Voltage

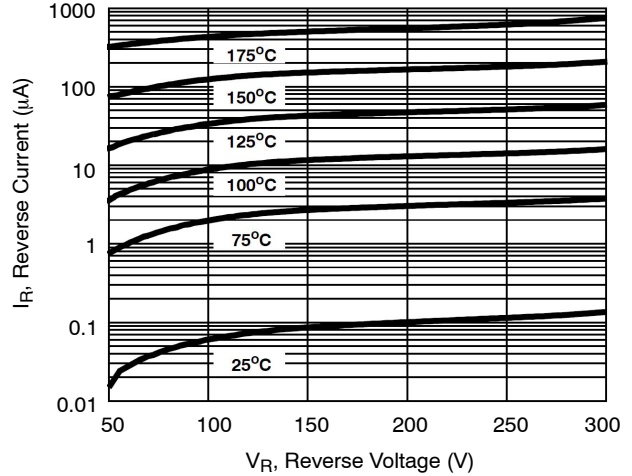

Figure 2. Reverse Current vs. Reverse Voltage

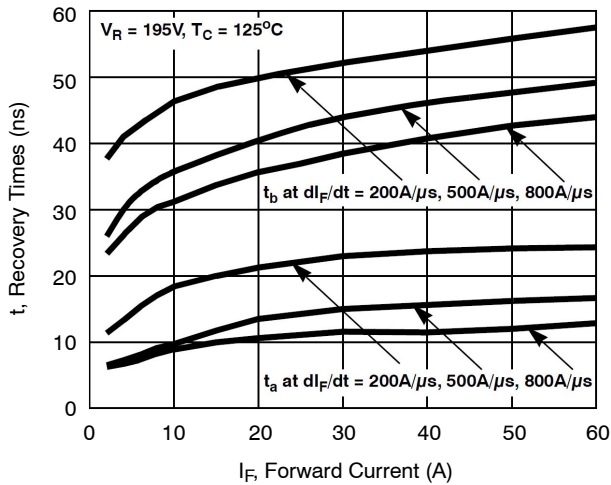

Figure 3.  $t_a$  and  $t_b$  Curves vs. Forward Current

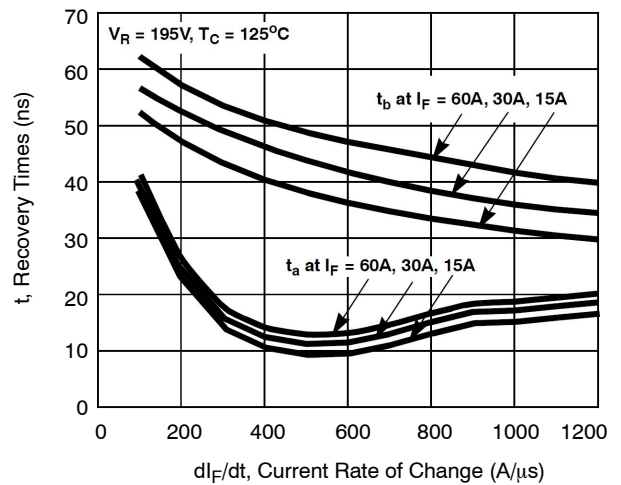

Figure 4.  $t_a$  and  $t_b$  Curves vs.  $di_F/dt$

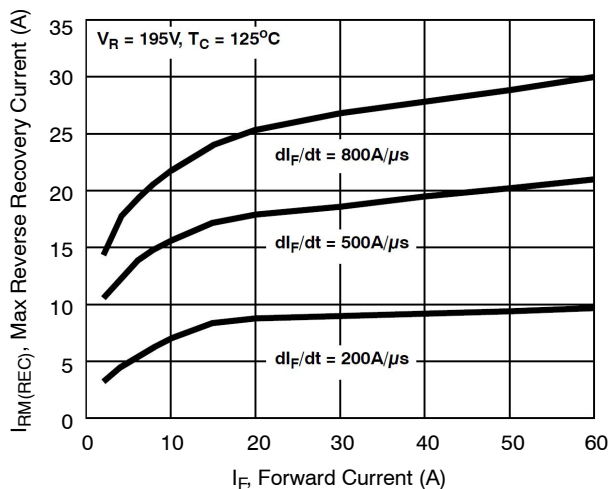

Figure 5. Maximum Reverse Recovery Current vs. Forward Current

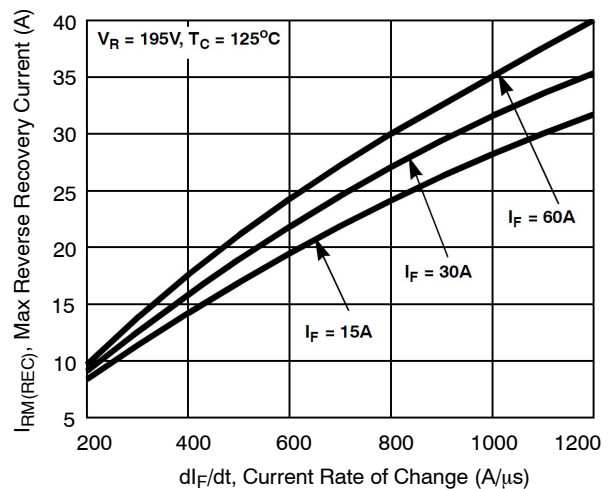
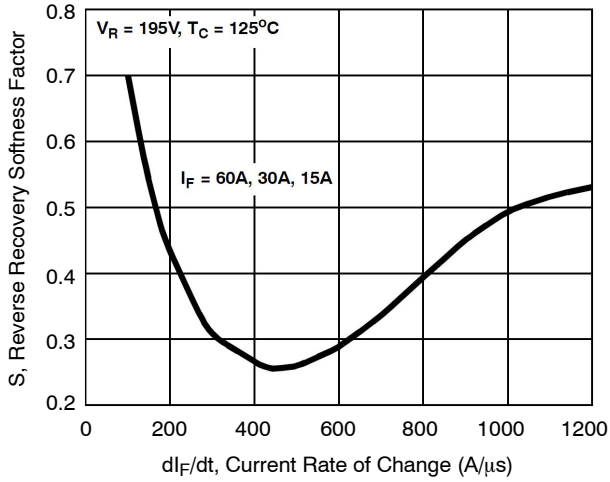

Figure 6. Maximum Reverse Recovery Current vs.  $di_F/dt$

# FFH30US30DN

## TYPICAL PERFORMANCE CHARACTERISTICS (per leg) (continued)



**Figure 7. Reverse Recovery Softness Factor vs.  $dI_F/dt$**

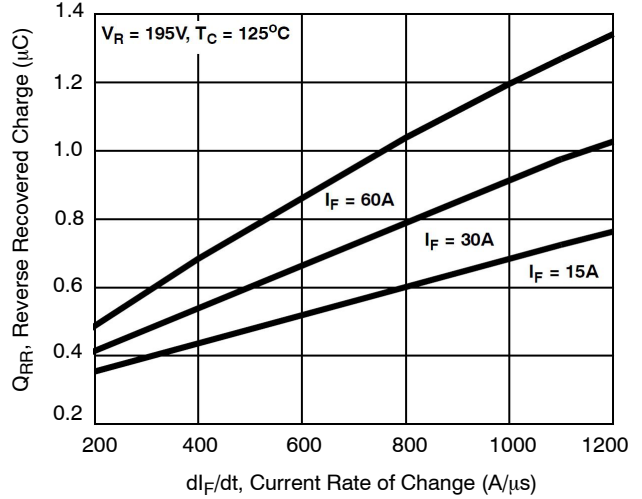

**Figure 8. Reverse Recovery Charge vs.  $dI_F/dt$**

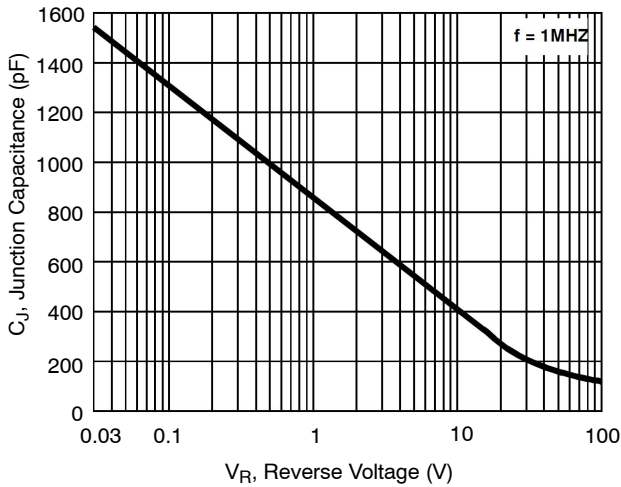

**Figure 9. Junction Capacitance vs. Reverse Voltage**

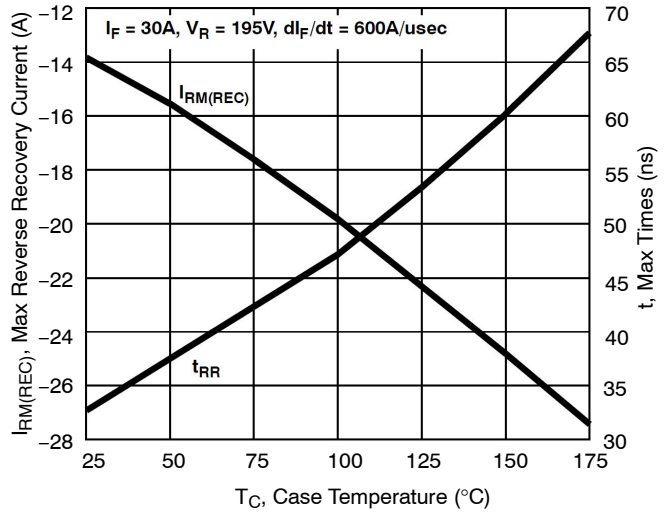

**Figure 10. Maximum Reverse Recovery Current and  $t_{rr}$  vs. Case Temperature**

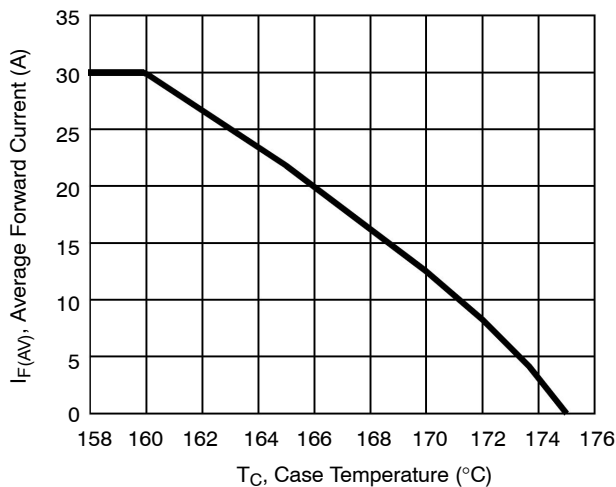

**Figure 11. DC Current Derating Curve**

TYPICAL PERFORMANCE CHARACTERISTICS (per leg) (continued)

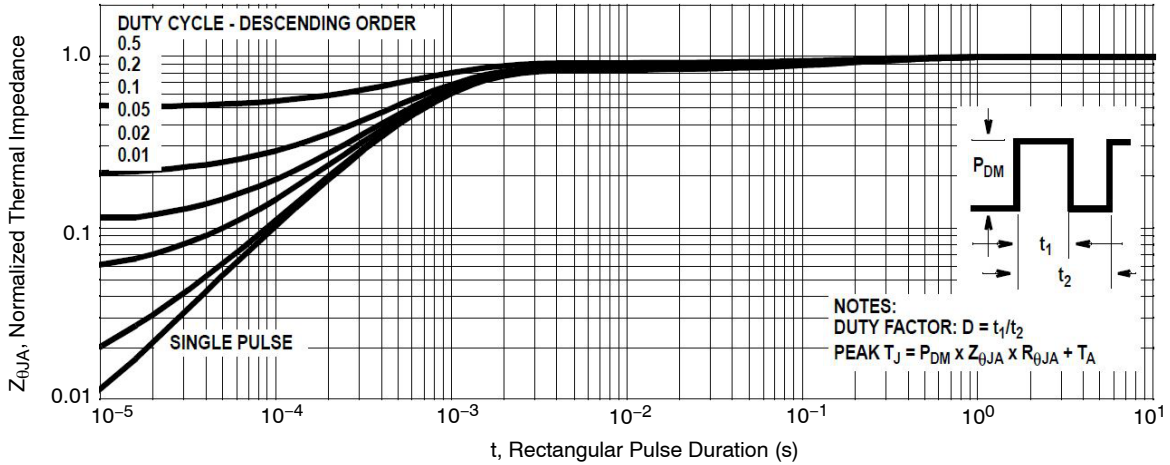

Figure 12. Normalized Maximum Transient Thermal Impedance

TEST CIRCUITS AND WAVEFORMS

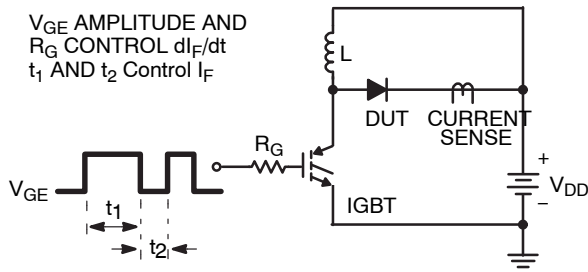

Figure 13.  $t_{rr}$  Test Circuit

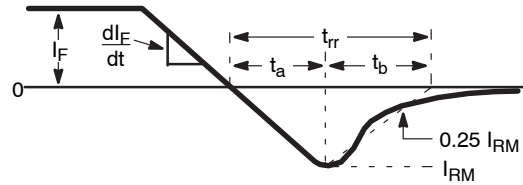

Figure 14.  $t_{rr}$  Waveforms and Definitions

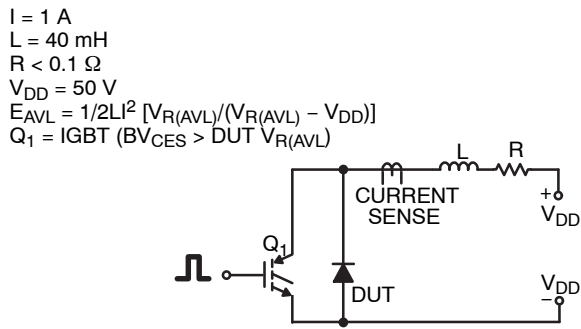

Figure 15. Avalanche Energy Test Circuit

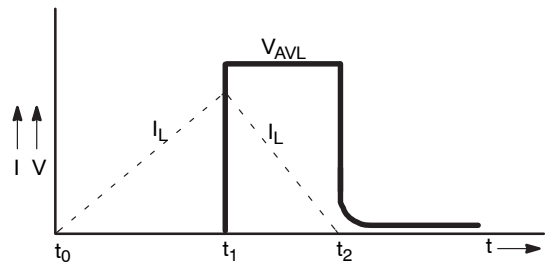
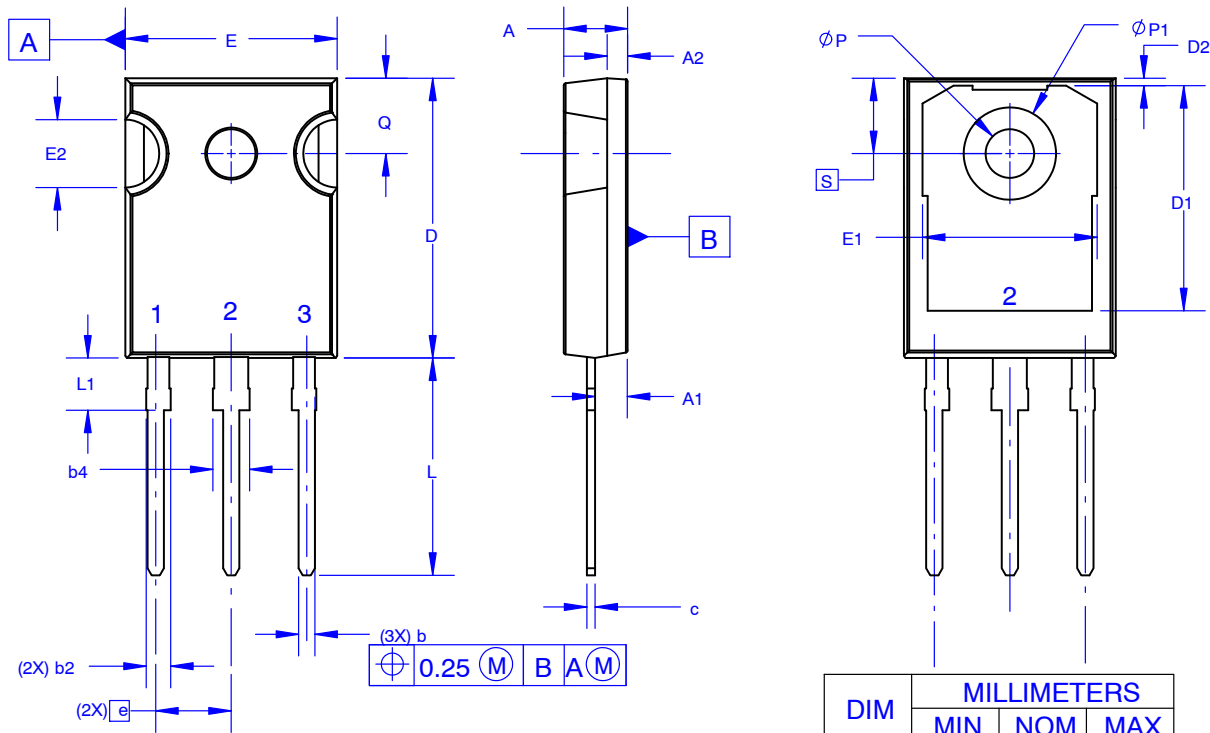

Figure 16. Avalanche Current and Voltage Waveforms

STEALTH is trademark of Semiconductor Components Industries, LLC (SCILLC) or its subsidiaries in the United States and/or other countries.

**TO-247-3LD SHORT LEAD**  
**CASE 340CK**  
**ISSUE A**

DATE 31 JAN 2019



NOTES: UNLESS OTHERWISE SPECIFIED.

- A. DIMENSIONS ARE EXCLUSIVE OF BURRS, MOLD FLASH, AND TIE BAR EXTRUSIONS.
- B. ALL DIMENSIONS ARE IN MILLIMETERS.
- C. DRAWING CONFORMS TO ASME Y14.5 - 2009.
- D. DIMENSION A1 TO BE MEASURED IN THE REGION DEFINED BY L1.
- E. LEAD FINISH IS UNCONTROLLED IN THE REGION DEFINED BY L1.

**GENERIC MARKING DIAGRAM\***

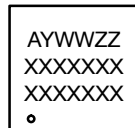

XXXX = Specific Device Code  
 A = Assembly Location  
 Y = Year  
 WW = Work Week  
 ZZ = Assembly Lot Code

\*This information is generic. Please refer to device data sheet for actual part marking. Pb-Free indicator, "G" or microdot "•", may or may not be present. Some products may not follow the Generic Marking.

DIM	MILLIMETERS		
	MIN	NOM	MAX
A	4.58	4.70	4.82
A1	2.20	2.40	2.60
A2	1.40	1.50	1.60
b	1.17	1.26	1.35
b2	1.53	1.65	1.77
b4	2.42	2.54	2.66
c	0.51	0.61	0.71
D	20.32	20.57	20.82
D1	13.08	~	~
D2	0.51	0.93	1.35
E	15.37	15.62	15.87
E1	12.81	~	~
E2	4.96	5.08	5.20
e	~	5.56	~
L	15.75	16.00	16.25
L1	3.69	3.81	3.93
ØP	3.51	3.58	3.65
ØP1	6.60	6.80	7.00
Q	5.34	5.46	5.58
S	5.34	5.46	5.58

<b>DOCUMENT NUMBER:</b>	98AON13851G	Electronic versions are uncontrolled except when accessed directly from the Document Repository. Printed versions are uncontrolled except when stamped "CONTROLLED COPY" in red.
<b>DESCRIPTION:</b>	TO-247-3LD SHORT LEAD	<b>PAGE 1 OF 1</b>

ON Semiconductor and are trademarks of Semiconductor Components Industries, LLC dba ON Semiconductor or its subsidiaries in the United States and/or other countries. ON Semiconductor reserves the right to make changes without further notice to any products herein. ON Semiconductor makes no warranty, representation or guarantee regarding the suitability of its products for any particular purpose, nor does ON Semiconductor assume any liability arising out of the application or use of any product or circuit, and specifically disclaims any and all liability, including without limitation special, consequential or incidental damages. ON Semiconductor does not convey any license under its patent rights nor the rights of others.

**onsemi**, **Onsemi**, and other names, marks, and brands are registered and/or common law trademarks of Semiconductor Components Industries, LLC dba "**onsemi**" or its affiliates and/or subsidiaries in the United States and/or other countries. **onsemi** owns the rights to a number of patents, trademarks, copyrights, trade secrets, and other intellectual property. A listing of **onsemi**'s product/patent coverage may be accessed at [www.onsemi.com/site/pdf/Patent-Marking.pdf](http://www.onsemi.com/site/pdf/Patent-Marking.pdf). **onsemi** reserves the right to make changes at any time to any products or information herein, without notice. The information herein is provided "as-is" and **onsemi** makes no warranty, representation or guarantee regarding the accuracy of the information, product features, availability, functionality, or suitability of its products for any particular purpose, nor does **onsemi** assume any liability arising out of the application or use of any product or circuit, and specifically disclaims any and all liability, including without limitation special, consequential or incidental damages. Buyer is responsible for its products and applications using **onsemi** products, including compliance with all laws, regulations and safety requirements or standards, regardless of any support or applications information provided by **onsemi**. "Typical" parameters which may be provided in **onsemi** data sheets and/or specifications can and do vary in different applications and actual performance may vary over time. All operating parameters, including "Typicals" must be validated for each customer application by customer's technical experts. **onsemi** does not convey any license under any of its intellectual property rights nor the rights of others. **onsemi** products are not designed, intended, or authorized for use as a critical component in life support systems or any FDA Class 3 medical devices or medical devices with a same or similar classification in a foreign jurisdiction or any devices intended for implantation in the human body. Should Buyer purchase or use **onsemi** products for any such unintended or unauthorized application, Buyer shall indemnify and hold **onsemi** and its officers, employees, subsidiaries, affiliates, and distributors harmless against all claims, costs, damages, and expenses, and reasonable attorney fees arising out of, directly or indirectly, any claim of personal injury or death associated with such unintended or unauthorized use, even if such claim alleges that **onsemi** was negligent regarding the design or manufacture of the part. **onsemi** is an Equal Opportunity/Affirmative Action Employer. This literature is subject to all applicable copyright laws and is not for resale in any manner.

## PUBLICATION ORDERING INFORMATION

### LITERATURE FULFILLMENT:

Email Requests to: [orderlit@onsemi.com](mailto:orderlit@onsemi.com)

**onsemi Website:** [www.onsemi.com](http://www.onsemi.com)

### TECHNICAL SUPPORT

**North American Technical Support:**

Voice Mail: 1 800-282-9855 Toll Free USA/Canada

Phone: 011 421 33 790 2910

**Europe, Middle East and Africa Technical Support:**

Phone: 00421 33 790 2910

For additional information, please contact your local Sales Representative