

Optocoupler, Photodarlington Output, Dual Channel, SOIC-8 Package

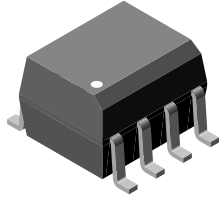

I179042

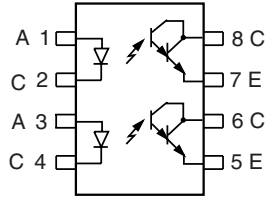

DESCRIPTION

The ILD223T is a high current transfer ratio (CTR) optocoupler. It has a gallium arsenide infrared LED emitter and silicon NPN photodarlington transistor detector.

This device has CTRs tested at an LED current of 1.0 mA. This low drive current permits easy interfacing from CMOS to LSTTL or TTL.

The ILD223T is constructed in a standard SOIC-8 foot print which makes it ideally suited for high density applications. In addition to eliminating through hole requirements, this package conforms to standards for surface mounted devices.

FEATURES

- Two channel optocoupler
- High current transfer ratio at $I_F = 1.0$ mA, 500 % minimum
- Isolation test voltage, 4000 V_{RMS}
- Electrical specifications similar to standard 6-pin coupler
- Compatible with dual wave, vapor phase and IR reflow soldering
- SOIC-8 surface mountable package
- Standard lead spacing, 0.05"
- Available only on tape and reel (conforms to EIA standard 481-2)
- Lead (Pb)-free component
- Component in accordance to RoHS 2002/95/EC and WEEE 2002/96/EC

RoHS
COMPLIANT

AGENCY APPROVALS

- UL1577, file no. E52744 system code Y
- CUL - file no. E52744, equivalent to CSA bulletin 5A
- DIN EN 60747-5-2 (VDE 0884) available with option 1

ORDER INFORMATION

PART	REMARKS
ILD223T	CTR > 500 %, SOIC-8

ABSOLUTE MAXIMUM RATINGS (1)

PARAMETER	TEST CONDITION	SYMBOL	VALUE	UNIT
INPUT				
Peak reverse voltage		V_R	6.0	V
Peak pulsed current	1.0 μ s, 300 pps		3.0	A
Continuous forward current per channel			30	mA
Power dissipation		P_{diss}	45	mW
Derate linearly from 25 °C			0.4	mW/°C
OUTPUT				
Collector emitter breakdown voltage		BV_{CEO}	30	V
Emitter collector breakdown voltage		BV_{ECO}	5.0	V
Power dissipation per channel		P_{diss}	75	mW
Derate linearly from 25 °C			3.1	mW/°C

Vishay Semiconductors Optocoupler, Photodarlington Output,
Dual Channel,
SOIC-8 Package

ABSOLUTE MAXIMUM RATINGS ⁽¹⁾				
PARAMETER	TEST CONDITION	SYMBOL	VALUE	UNIT
COUPLER				
Isolation test voltage	t = 1.0 s	V _{ISO}	4000	V _{RMS}
Total package dissipation (2 LEDs and 2 detectors, 2 channels)		P _{tot}	250	mW
Derate linearly from 25 °C			2.0	mW/°C
Storage temperature		T _{stg}	- 55 to + 150	°C
Operating temperature		T _{amb}	- 55 to + 100	°C
Soldering temperature ⁽²⁾		T _{slid}	260	°C

Notes

⁽¹⁾ T_{amb} = 25 °C, unless otherwise specified

Stresses in excess of the absolute maximum ratings can cause permanent damage to the device. Functional operation of the device is not implied at these or any other conditions in excess of those given in the operational sections of this document. Exposure to absolute maximum ratings for extended periods of the time can adversely affect reliability.

⁽²⁾ Refer to reflow profile for soldering conditions for surface mounted devices (SOP/SOIC).

ELECTRICAL CHARACTERISTICS							
PARAMETER	TEST CONDITION	PART	SYMBOL	MIN.	TYP.	MAX.	UNIT
INPUT							
Forward voltage	I _F = 10 mA		V _F			1.3	V
Reverse current	V _R = 6.0 V		I _R		0.1	100	μA
Capacitance	V _F = 0 V, f = 1.0 MHz		C _O		25		pF
OUTPUT							
Collector emitter breakdown voltage	I _C = 10 μA		BV _{CEO}	30			V
Emitter collector breakdown voltage	I _C = 10 μA		BV _{CEO}	5.0			V
Collector emitter leakage current	V _{CE} = 50 V, I _F = 0 A		I _{CEO}			50	nA
Collector emitter capacitance	V _{CE} = 5.0 V		C _{CE}		3.4		pF
COUPLER							
Capacitance (input to output)		ILD223T	C _{IO}	0.5			pF
Saturation voltage, collector emitter	I _F = 1.0 mA, I _{CE} = 0.5 mA	ILD223T	V _{CEsat}			1.0	V
Resistance, input to output		ILD223T	C _{IO}	100			GΩ

Note

T_{amb} = 25 °C, unless otherwise specified

Minimum and maximum values are testing requirements. Typical values are characteristics of the device and are the result of engineering evaluation. Typical values are for information only and are not part of the testing requirements.

CURRENT TRANSFER RATIO						
PARAMETER	TEST CONDITION	SYMBOL	MIN.	TYP.	MAX.	UNIT
DC current transfer ratio	I _F = 1.0 mA, V _{CE} = 5.0 V	CTR _{DC}	500			%

SWITCHING CHARACTERISTICS							
PARAMETER	TEST CONDITION	PART	SYMBOL	MIN.	TYP.	MAX.	UNIT
Turn-on time	V _{CC} = 10 V, R _L = 100 Ω, I _F = 5.0 mA	ILD223T	t _{on}	15			μs
Turn-off time	V _{CC} = 10 V, R _L = 100 Ω, I _F = 5.0 mA	ILD223T	t _{off}	30			μs



Optocoupler, Photodarlington Output, Vishay Semiconductors
Dual Channel, SOIC-8 Package

SAFETY AND INSULATION RATINGS						
PARAMETER	TEST CONDITION	SYMBOL	MIN.	TYP.	MAX.	UNIT
Climatic classification (according to IEC 68 part 1)				55/100/21		
Comparative tracking index		CTI	175		399	
V_{IOTM}			6000			V
V_{IORM}			560			V
P_{SO}					350	mW
I_{SI}					150	mA
T_{SI}					165	°C
Creepage distance			4			mm
Clearance distance			4			mm
Insulation thickness, reinforced rated	per IEC 60950 2.10.5.1		0.2			mm

Note

As per IEC 60747-5-2, §7.4.3.8.1, this optocoupler is suitable for “safe electrical insulation” only within the safety ratings. Compliance with the safety ratings shall be ensured by means of protective circuits.

TYPICAL CHARACTERISTICS

$T_{amb} = 25\text{ °C}$, unless otherwise specified

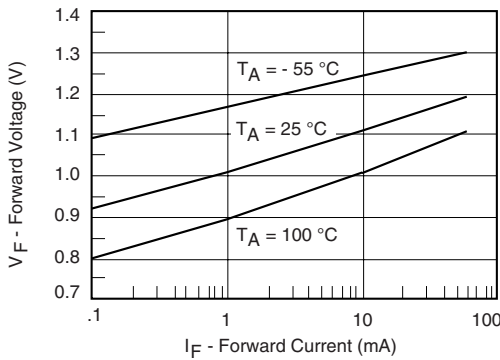

ild223t_01

Fig. 3 - Forward Voltage vs. Forward Current

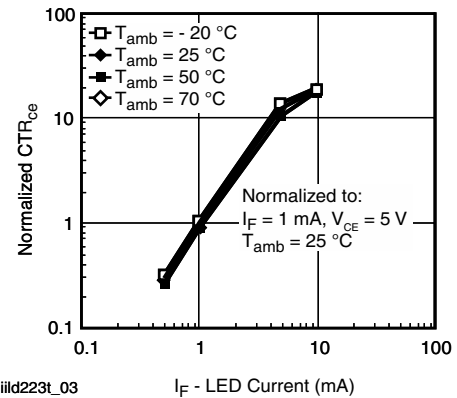

ild223t_03

Fig. 5 - Normalized CTR_{ce} vs. LED Current

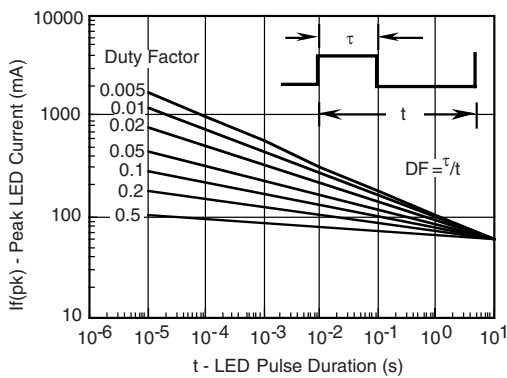

ild223t_02

Fig. 4 - Peak LED Current vs. Duty Factor, τ

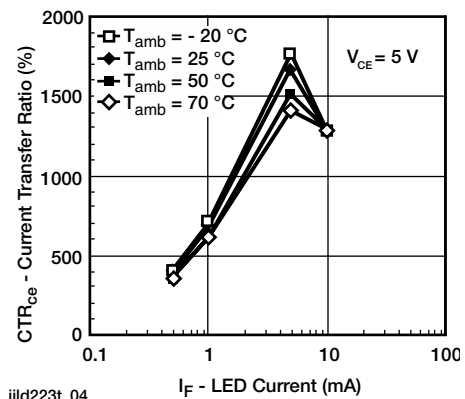

ild223t_04

Fig. 6 - CTR_{ce} vs. LED Current

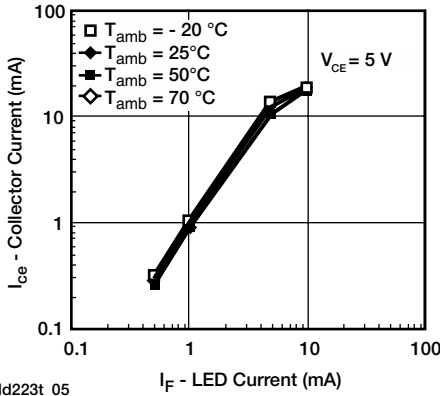

iiid223t_05

Fig. 7 - Collector Current vs. LED Current

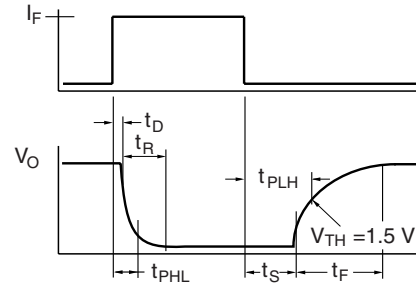

iiid223t_07

Fig. 9 - Switching Timing

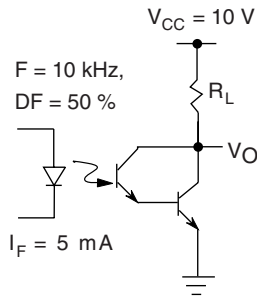

iiid223t_06

Fig. 8 - Switching Schematic

PACKAGE DIMENSIONS in inches (millimeters)

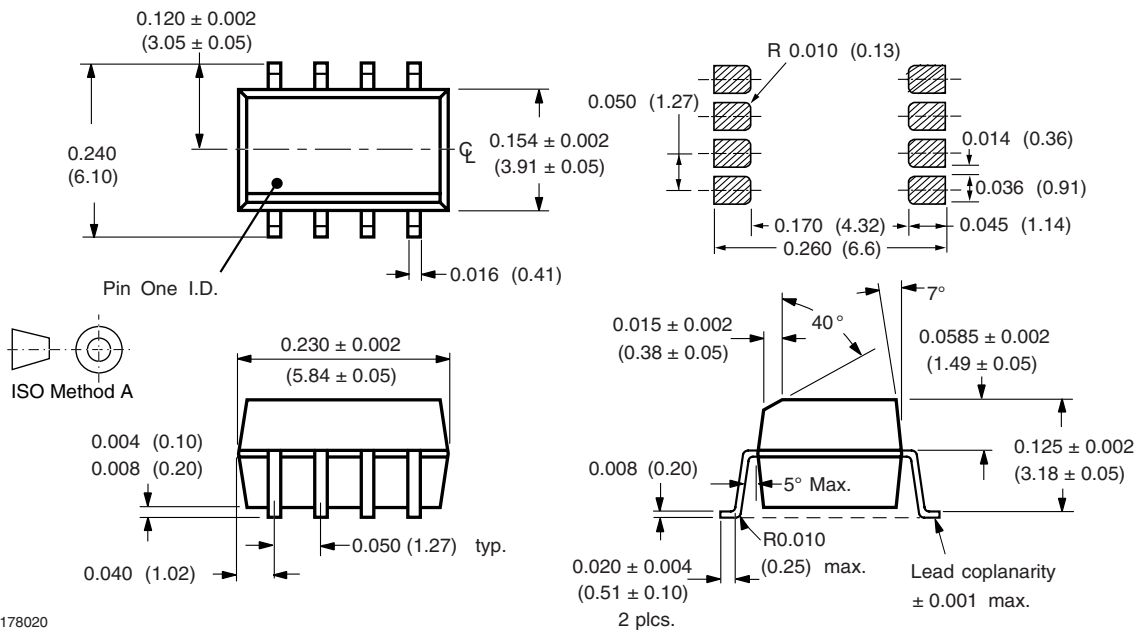

ii178020



Optocoupler, Photodarlington Output, Vishay Semiconductors
Dual Channel,
SOIC-8 Package

OZONE DEPLETING SUBSTANCES POLICY STATEMENT

It is the policy of Vishay Semiconductor GmbH to

1. Meet all present and future national and international statutory requirements.
2. Regularly and continuously improve the performance of our products, processes, distribution and operating systems with respect to their impact on the health and safety of our employees and the public, as well as their impact on the environment.

It is particular concern to control or eliminate releases of those substances into the atmosphere which are known as ozone depleting substances (ODSs).

The Montreal Protocol (1987) and its London Amendments (1990) intend to severely restrict the use of ODSs and forbid their use within the next ten years. Various national and international initiatives are pressing for an earlier ban on these substances.

Vishay Semiconductor GmbH has been able to use its policy of continuous improvements to eliminate the use of ODSs listed in the following documents.

1. Annex A, B and list of transitional substances of the Montreal Protocol and the London Amendments respectively.
2. Class I and II ozone depleting substances in the Clean Air Act Amendments of 1990 by the Environmental Protection Agency (EPA) in the USA
3. Council Decision 88/540/EEC and 91/690/EEC Annex A, B and C (transitional substances) respectively.

Vishay Semiconductor GmbH can certify that our semiconductors are not manufactured with ozone depleting substances and do not contain such substances.

We reserve the right to make changes to improve technical design
and may do so without further notice.

Parameters can vary in different applications. All operating parameters must be validated for each customer application by the customer. Should the buyer use Vishay Semiconductors products for any unintended or unauthorized application, the buyer shall indemnify Vishay Semiconductors against all claims, costs, damages, and expenses, arising out of, directly or indirectly, any claim of personal damage, injury or death associated with such unintended or unauthorized use.

Vishay Semiconductor GmbH, P.O.B. 3535, D-74025 Heilbronn, Germany



Disclaimer

ALL PRODUCT, PRODUCT SPECIFICATIONS AND DATA ARE SUBJECT TO CHANGE WITHOUT NOTICE TO IMPROVE RELIABILITY, FUNCTION OR DESIGN OR OTHERWISE.

Vishay Intertechnology, Inc., its affiliates, agents, and employees, and all persons acting on its or their behalf (collectively, "Vishay"), disclaim any and all liability for any errors, inaccuracies or incompleteness contained in any datasheet or in any other disclosure relating to any product.

Vishay makes no warranty, representation or guarantee regarding the suitability of the products for any particular purpose or the continuing production of any product. To the maximum extent permitted by applicable law, Vishay disclaims (i) any and all liability arising out of the application or use of any product, (ii) any and all liability, including without limitation special, consequential or incidental damages, and (iii) any and all implied warranties, including warranties of fitness for particular purpose, non-infringement and merchantability.

Statements regarding the suitability of products for certain types of applications are based on Vishay's knowledge of typical requirements that are often placed on Vishay products in generic applications. Such statements are not binding statements about the suitability of products for a particular application. It is the customer's responsibility to validate that a particular product with the properties described in the product specification is suitable for use in a particular application. Parameters provided in datasheets and / or specifications may vary in different applications and performance may vary over time. All operating parameters, including typical parameters, must be validated for each customer application by the customer's technical experts. Product specifications do not expand or otherwise modify Vishay's terms and conditions of purchase, including but not limited to the warranty expressed therein.

Except as expressly indicated in writing, Vishay products are not designed for use in medical, life-saving, or life-sustaining applications or for any other application in which the failure of the Vishay product could result in personal injury or death. Customers using or selling Vishay products not expressly indicated for use in such applications do so at their own risk. Please contact authorized Vishay personnel to obtain written terms and conditions regarding products designed for such applications.

No license, express or implied, by estoppel or otherwise, to any intellectual property rights is granted by this document or by any conduct of Vishay. Product names and markings noted herein may be trademarks of their respective owners.