

PolarHV™ HiPerFET Power MOSFET

IXFH 24N80P
IXFK 24N80P
IXFT 24N80P

$V_{DSS} = 800 \text{ V}$
 $I_{D25} = 24 \text{ A}$
 $R_{DS(on)} \leq 400 \text{ m}\Omega$
 $t_{rr} \leq 250 \text{ ns}$

N-Channel Enhancement Mode
Avalanche Rated
Fast Intrinsic Diode

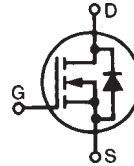

| Symbol | Test Conditions | Maximum Ratings | |
|------------|---|-------------------|------------------|
| V_{DSS} | $T_J = 25^\circ\text{C}$ to 150°C | 800 | V |
| V_{DGR} | $T_J = 25^\circ\text{C}$ to 150°C ; $R_{GS} = 1 \text{ M}\Omega$ | 800 | V |
| V_{GSS} | Continuous | ± 30 | V |
| V_{GSM} | Transient | ± 40 | V |
| I_{D25} | $T_C = 25^\circ\text{C}$ | 24 | A |
| I_{DM} | $T_C = 25^\circ\text{C}$, pulse width limited by T_{JM} | 55 | A |
| I_{AR} | $T_C = 25^\circ\text{C}$ | 12 | A |
| E_{AR} | $T_C = 25^\circ\text{C}$ | 50 | mJ |
| E_{AS} | $T_C = 25^\circ\text{C}$ | 1.5 | J |
| dv/dt | $I_S \leq I_{DM}$, di/dt $\leq 100 \text{ A}/\mu\text{s}$, $V_{DD} \leq V_{DSS}$, $T_J \leq 150^\circ\text{C}$, $R_G = 2 \Omega$ | 10 | V/ns |
| P_D | $T_C = 25^\circ\text{C}$ | 650 | W |
| T_J | | -55 ... +150 | $^\circ\text{C}$ |
| T_{JM} | | 150 | $^\circ\text{C}$ |
| T_{stg} | | -55 ... +150 | $^\circ\text{C}$ |
| M_d | Mounting torque (TO-247 & TO-264) | 1.13/10 Nm/lb.in. | |
| Weight | TO-247 | 6 | g |
| | TO-268 | 5 | g |
| | TO-264 | 10 | g |
| T_L | 1.6 mm (0.062 in.) from case for 10 s | 300 | $^\circ\text{C}$ |
| T_{SOLD} | Plastic body for 10 s | 260 | $^\circ\text{C}$ |

TO-247 (IXFH)

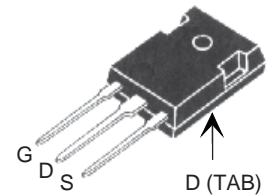

TO-268 (IXFT) Case Style

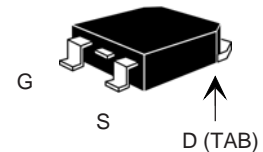

TO-264 AA (IXFK)

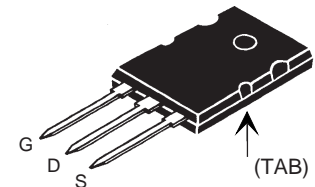

G = Gate D = Drain
S = Source Tab = Drain

Features

- International standard packages
- Fast recovery diode
- Unclamped Inductive Switching (UIS) rated
- Low package inductance
 - easy to drive and to protect

Advantages

- Easy to mount
- Space savings
- High power density

| Symbol | Test Conditions | Characteristic Values | | |
|--------------|--|-----------------------|------|----------------------|
| | | Min. | Typ. | Max. |
| BV_{DSS} | $V_{GS} = 0 \text{ V}$, $I_D = 250 \mu\text{A}$ | 800 | | V |
| $V_{GS(th)}$ | $V_{DS} = V_{GS}$, $I_D = 4 \text{ mA}$ | 3.0 | | 5.0 V |
| I_{GSS} | $V_{GS} = \pm 30 \text{ V}$, $V_{DS} = 0 \text{ V}$ | | | $\pm 100 \text{ nA}$ |
| I_{DSS} | $V_{DS} = V_{DSS}$ | | | 25 μA |
| | $V_{GS} = 0 \text{ V}$ $T_J = 125^\circ\text{C}$ | | | 1000 μA |
| $R_{DS(on)}$ | $V_{GS} = 10 \text{ V}$, $I_D = 0.5 I_{D25}$ Pulse test, $t \leq 300 \mu\text{s}$, duty cycle $d \leq 2 \%$ | | | 400 $\text{m}\Omega$ |

| Symbol | Test Conditions | Characteristic Values ($T_J = 25^\circ\text{C}$, unless otherwise specified) | | |
|--------------|--|---|------|--------------------|
| | | Min. | Typ. | Max. |
| g_{fs} | $V_{DS} = 20\text{ V}; I_D = 0.5 I_{D25}$ pulse test | 15 | 25 | S |
| C_{iss} | $V_{GS} = 0\text{ V}, V_{DS} = 25\text{ V}, f = 1\text{ MHz}$ | | 7200 | pF |
| C_{oss} | | | 470 | pF |
| C_{rss} | | | 26 | pF |
| $t_{d(on)}$ | $V_{GS} = 10\text{ V}, V_{DS} = 0.5 I_{D25}$ $R_G = 2\ \Omega$ (External) | | 32 | ns |
| t_r | | | 27 | ns |
| $t_{d(off)}$ | | | 75 | ns |
| t_f | | | 24 | ns |
| $Q_{g(on)}$ | $V_{GS} = 10\text{ V}, V_{DS} = 0.5 V_{DSS}, I_D = 0.5 I_{D25}$ | | 105 | nC |
| Q_{gs} | | | 30 | nC |
| Q_{gd} | | | 33 | nC |
| R_{thJC} | | | 0.19 | $^\circ\text{C/W}$ |
| R_{thCS} | TO-247 | | 0.21 | $^\circ\text{C/W}$ |
| R_{thCS} | TO-264 | | 0.15 | $^\circ\text{C/W}$ |

| Symbol | Test Conditions | Characteristic Values ($T_J = 25^\circ\text{C}$, unless otherwise specified) | | |
|----------|---|---|------|---------------|
| | | Min. | Typ. | Max. |
| I_S | $V_{GS} = 0\text{ V}$ | | | 24 A |
| I_{SM} | Repetitive | | | 55 A |
| V_{SD} | $I_F = I_S, V_{GS} = 0\text{ V}$, Pulse test, $t \leq 300\ \mu\text{s}$, duty cycle $d \leq 2\%$ | | | 1.5 V |
| t_{rr} | $I_F = 25\text{ A}, -di/dt = 100\text{ A}/\mu\text{s}$ $V_R = 100\text{ V}$ | | | 250 ns |
| Q_{RM} | | | 0.8 | μC |
| I_{RM} | | | 6.0 | A |

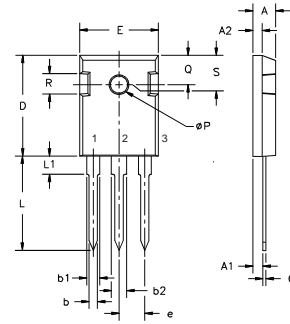
TO-247 AD (IXFH) Outline

| Dim. | Millimeter | | Inches | |
|----------------|------------|-------|--------|-------|
| | Min. | Max. | Min. | Max. |
| A | 4.7 | 5.3 | .185 | .209 |
| A ₁ | 2.2 | 2.54 | .087 | .102 |
| A ₂ | 2.2 | 2.6 | .059 | .098 |
| b | 1.0 | 1.4 | .040 | .055 |
| b ₁ | 1.65 | 2.13 | .065 | .084 |
| b ₂ | 2.87 | 3.12 | .113 | .123 |
| C | .4 | .8 | .016 | .031 |
| D | 20.80 | 21.46 | .819 | .845 |
| E | 15.75 | 16.26 | .610 | .640 |
| e | 5.20 | 5.72 | 0.205 | 0.225 |
| L | 19.81 | 20.32 | .780 | .800 |
| L1 | | 4.50 | | .177 |
| ∅P | 3.55 | 3.65 | .140 | .144 |
| Q | 5.89 | 6.40 | 0.232 | 0.252 |
| R | 4.32 | 5.49 | .170 | .216 |
| S | 6.15 | BSC | 242 | BSC |

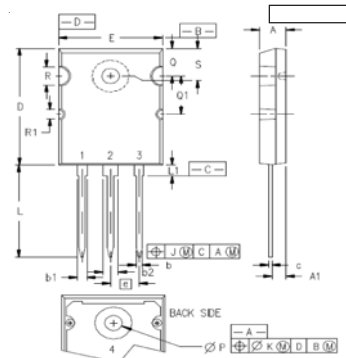
TO-264 (IXFK) Outline

- 1 - GATE
2, 4 - DRAIN (COLLECTOR)
3 - SOURCE (EMITTER)

| SYM | INCHES | | MILLIMETERS | |
|-----------------|----------|-------|-------------|-------|
| | MIN | MAX | MIN | MAX |
| A | .185 | .209 | 4.70 | 5.31 |
| A ₁ | .102 | .118 | 2.59 | 3.00 |
| b | .037 | .055 | 0.94 | 1.40 |
| b ₁ | .087 | .102 | 2.21 | 2.59 |
| b ₂ | .110 | .126 | 2.79 | 3.20 |
| c | .017 | .029 | 0.43 | 0.74 |
| D | 1.007 | 1.047 | 25.58 | 26.59 |
| E | .760 | .799 | 19.30 | 20.29 |
| e | .215 BSC | | 5.46 BSC | |
| J | .000 | .010 | 0.00 | 0.25 |
| K | .000 | .010 | 0.00 | 0.25 |
| L | .779 | .842 | 19.79 | 21.39 |
| L ₁ | .087 | .102 | 2.21 | 2.59 |
| ∅P | .122 | .138 | 3.10 | 3.51 |
| Q | .240 | .256 | 6.10 | 6.50 |
| Q ₁ | .330 | .346 | 8.38 | 8.79 |
| ∅R | .155 | .187 | 3.94 | 4.75 |
| ∅R ₁ | .085 | .093 | 2.16 | 2.36 |
| S | .243 | .253 | 6.17 | 6.43 |

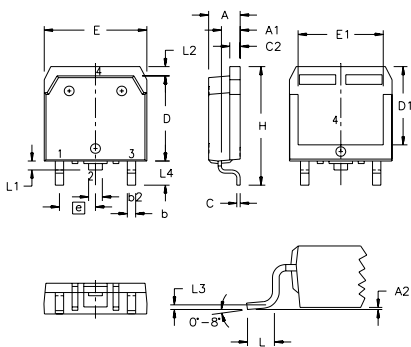
TO-268 (IXFT) Outline

| SYM | INCHES | | MILLIMETERS | |
|----------------|----------|------|-------------|-------|
| | MIN | MAX | MIN | MAX |
| A | .193 | .201 | 4.90 | 5.10 |
| A ₁ | .106 | .114 | 2.70 | 2.90 |
| A ₂ | .001 | .010 | 0.02 | 0.25 |
| b | .045 | .057 | 1.15 | 1.45 |
| b ₂ | .075 | .083 | 1.90 | 2.10 |
| C | .016 | .026 | 0.40 | 0.65 |
| C ₂ | .057 | .063 | 1.45 | 1.60 |
| D | .543 | .551 | 13.80 | 14.00 |
| D ₁ | .488 | .500 | 12.40 | 12.70 |
| E | .624 | .632 | 15.85 | 16.05 |
| E ₁ | .524 | .535 | 13.30 | 13.60 |
| e | .215 BSC | | 5.45 BSC | |
| H | .736 | .752 | 18.70 | 19.10 |
| L | .094 | .106 | 2.40 | 2.70 |
| L ₁ | .047 | .055 | 1.20 | 1.40 |
| L ₂ | .039 | .045 | 1.00 | 1.15 |
| L ₃ | .010 BSC | | 0.25 BSC | |
| L ₄ | .150 | .161 | 3.80 | 4.10 |

IXYS reserves the right to change limits, test conditions, and dimensions.

IXYS MOSFETs and IGBTs are covered by 4,835,592 4,931,844 5,049,961 5,237,481 6,162,665 6,404,065 B1 6,683,344 6,727,585 7,005,734 B2
one or more of the following U.S. patents: 4,850,072 5,017,508 5,063,307 5,381,025 6,259,123 B1 6,534,343 6,710,405 B2 6,759,692
4,881,106 5,034,796 5,187,117 5,486,715 6,306,728 B1 6,583,505 6,710,463 6,771,478 B2

Fig. 1. Output Characteristics @ 25°C

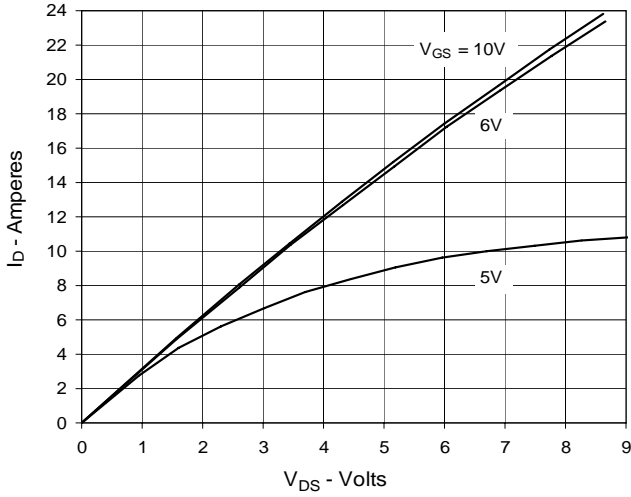

Fig. 2. Extended Output Characteristics @ 25°C

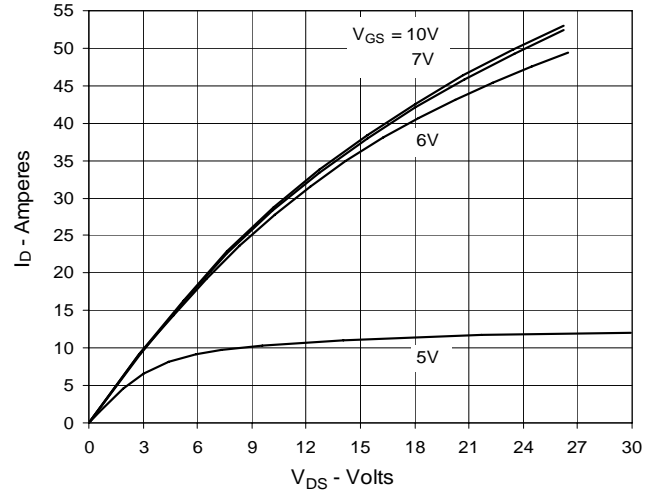

Fig. 3. Output Characteristics @ 125°C

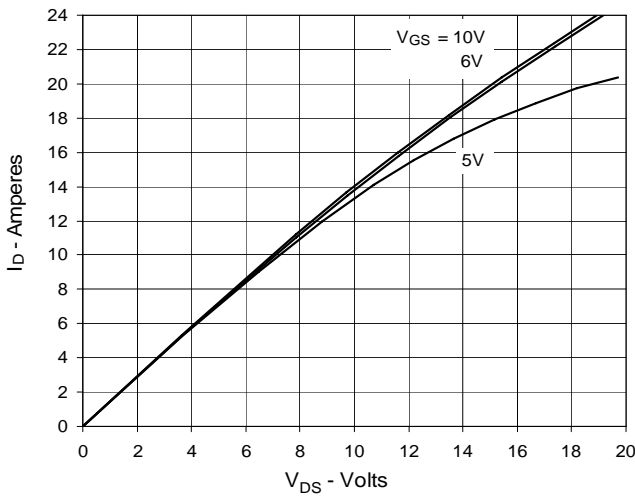

Fig. 4. $R_{DS(on)}$ Normalized to $I_D = 12A$ Value vs. Junction Temperature

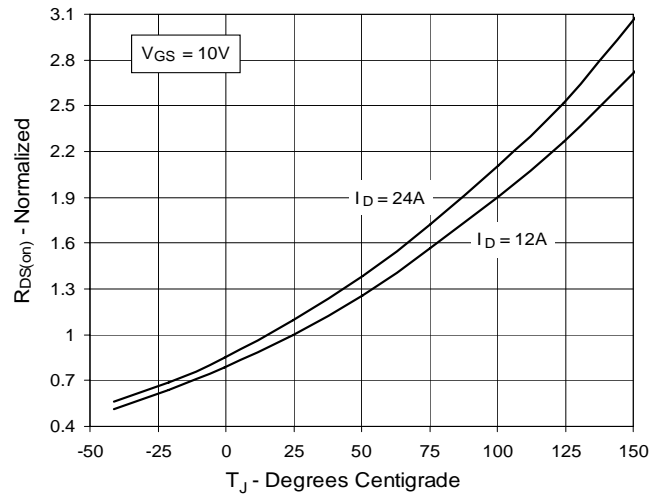

Fig. 5. $R_{DS(on)}$ Normalized to $I_D = 12A$ Value vs. Drain Current

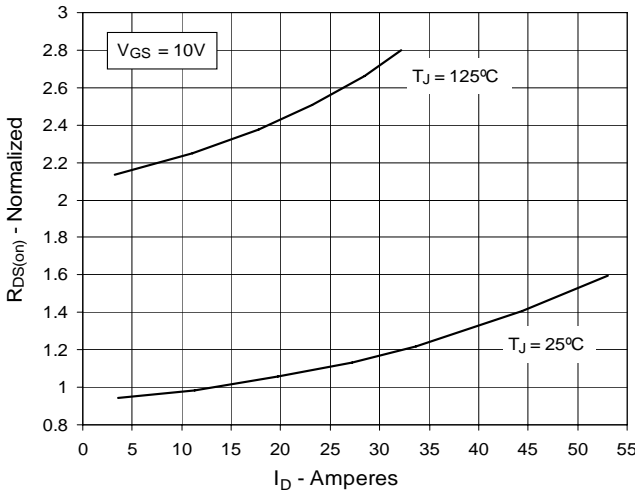

Fig. 6. Maximum Drain Current vs. Case Temperature

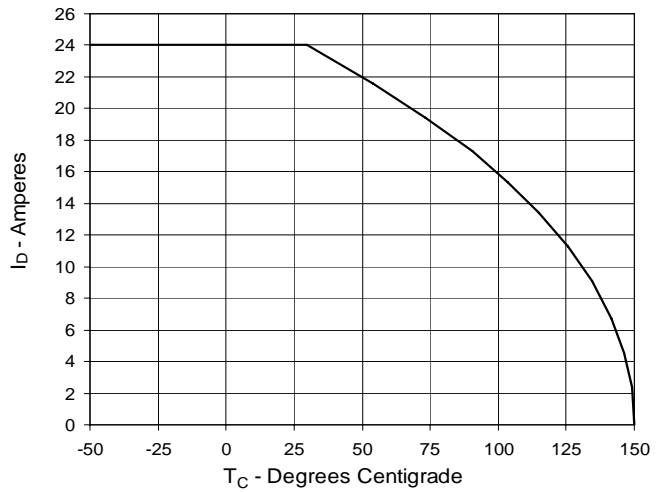

Fig. 7. Input Admittance

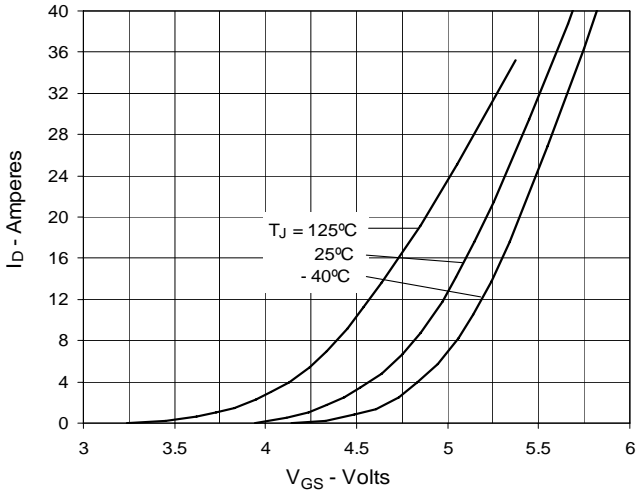

Fig. 8. Transconductance

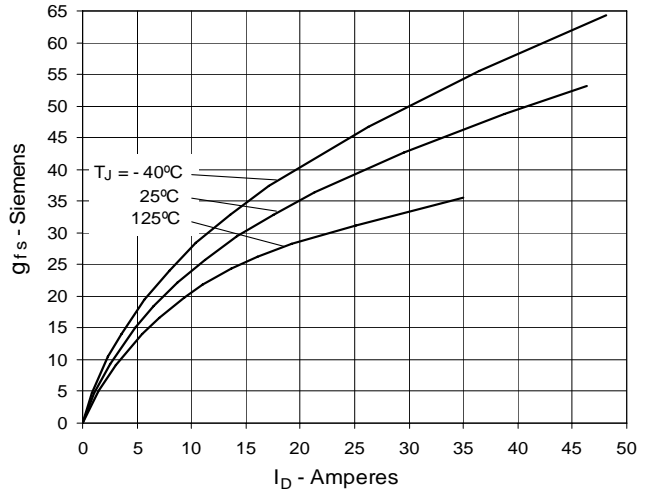

Fig. 9. Forward Voltage Drop of Intrinsic Diode

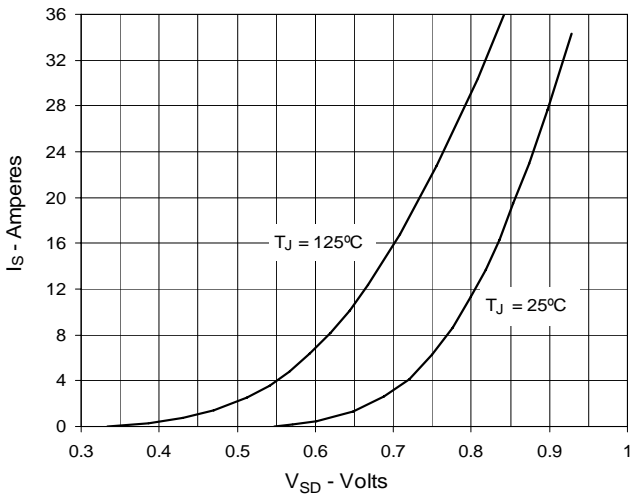

Fig. 10. Gate Charge

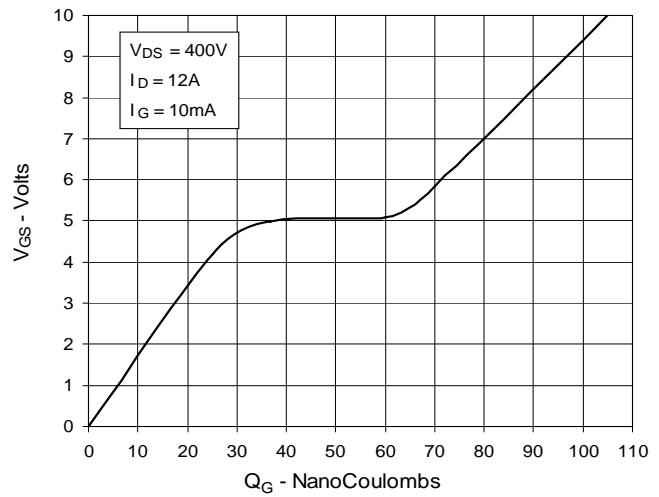

Fig. 11. Capacitance

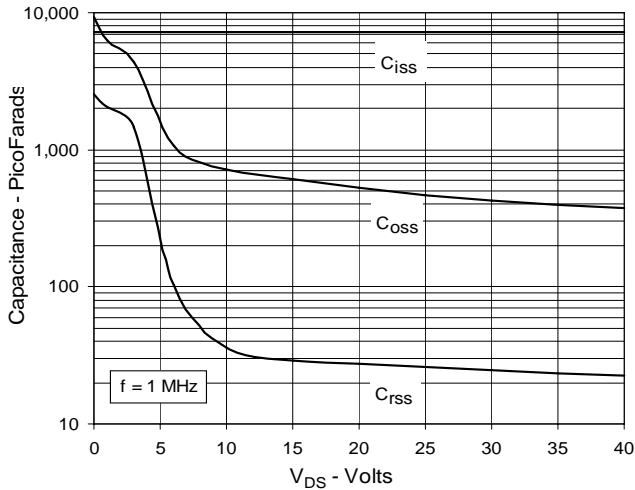

Fig. 12. Maximum Transient Thermal Resistance

