



Is Now Part of



ON Semiconductor®

To learn more about ON Semiconductor, please visit our website at
www.onsemi.com

Please note: As part of the Fairchild Semiconductor integration, some of the Fairchild orderable part numbers will need to change in order to meet ON Semiconductor's system requirements. Since the ON Semiconductor product management systems do not have the ability to manage part nomenclature that utilizes an underscore (_), the underscore (_) in the Fairchild part numbers will be changed to a dash (-). This document may contain device numbers with an underscore (_). Please check the ON Semiconductor website to verify the updated device numbers. The most current and up-to-date ordering information can be found at www.onsemi.com. Please email any questions regarding the system integration to Fairchild_questions@onsemi.com.

ON Semiconductor and the ON Semiconductor logo are trademarks of Semiconductor Components Industries, LLC dba ON Semiconductor or its subsidiaries in the United States and/or other countries. ON Semiconductor owns the rights to a number of patents, trademarks, copyrights, trade secrets, and other intellectual property. A listing of ON Semiconductor's product/patent coverage may be accessed at www.onsemi.com/site/pdf/Patent-Marking.pdf. ON Semiconductor reserves the right to make changes without further notice to any products herein. ON Semiconductor makes no warranty, representation or guarantee regarding the suitability of its products for any particular purpose, nor does ON Semiconductor assume any liability arising out of the application or use of any product or circuit, and specifically disclaims any and all liability, including without limitation special, consequential or incidental damages. Buyer is responsible for its products and applications using ON Semiconductor products, including compliance with all laws, regulations and safety requirements or standards, regardless of any support or applications information provided by ON Semiconductor. "Typical" parameters which may be provided in ON Semiconductor data sheets and/or specifications can and do vary in different applications and actual performance may vary over time. All operating parameters, including "Typicals" must be validated for each customer application by customer's technical experts. ON Semiconductor does not convey any license under its patent rights nor the rights of others. ON Semiconductor products are not designed, intended, or authorized for use as a critical component in life support systems or any FDA Class 3 medical devices or medical devices with a same or similar classification in a foreign jurisdiction or any devices intended for implantation in the human body. Should Buyer purchase or use ON Semiconductor products for any such unintended or unauthorized application, Buyer shall indemnify and hold ON Semiconductor and its officers, employees, subsidiaries, affiliates, and distributors harmless against all claims, costs, damages, and expenses, and reasonable attorney fees arising out of, directly or indirectly, any claim of personal injury or death associated with such unintended or unauthorized use, even if such claim alleges that ON Semiconductor was negligent regarding the design or manufacture of the part. ON Semiconductor is an Equal Opportunity/Affirmative Action Employer. This literature is subject to all applicable copyright laws and is not for resale in any manner.



September 2014

KA317 / LM317 3-Terminal Positive Adjustable Regulator

Features

- Output-Current In Excess of 1.5 A
- Output-Adjustable Between 1.2 V and 37 V
- Internal Thermal Overload Protection
- Internal Short-Circuit Current Limiting
- Output-Transistor Safe Operating Area Compensation
- TO-220 Package

Description

This monolithic integrated circuit is an adjustable 3-terminal positive-voltage regulator designed to supply more than 1.5 A of load current with an output voltage adjustable over a 1.2 V to 37 V range. It employs internal current limiting, thermal shutdown, and safe area compensation.

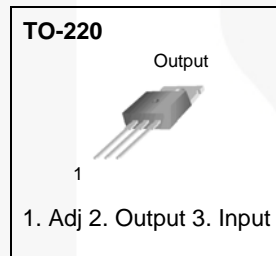

Ordering Information

Product Number	Package	Packing Method	Operating Temperature
LM317T	TO-220 (Single Gauge)	Rail	0°C to +125°C
KA317TU	TO-220 (Dual Gauge)	Rail	0°C to +125°C

Block Diagram

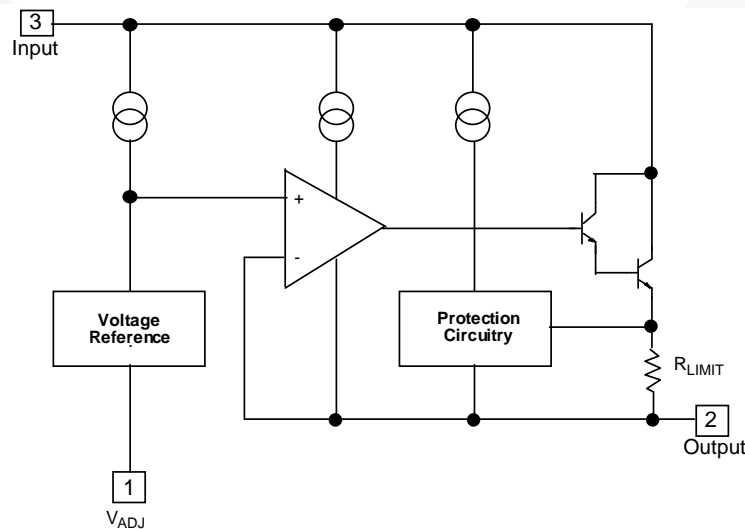

Figure 1. Block Diagram

KA317 / LM317 — 3-Terminal Positive Adjustable Regulator

Absolute Maximum Ratings

Stresses exceeding the absolute maximum ratings may damage the device. The device may not function or be operable above the recommended operating conditions and stressing the parts to these levels is not recommended. In addition, extended exposure to stresses above the recommended operating conditions may affect device reliability. The absolute maximum ratings are stress ratings only. Values are at $T_A = 25^\circ\text{C}$ unless otherwise noted.

Symbol	Parameter	Value	Unit
$V_I - V_O$	Input-Output Voltage Differential	40	V
T_{LEAD}	Lead Temperature	230	$^\circ\text{C}$
T_J	Operating Junction Temperature Range	0 to +125	$^\circ\text{C}$
T_{STG}	Storage Temperature Range	-65 to +125	$^\circ\text{C}$
$\Delta V_O/\Delta T$	Temperature Coefficient of Output Voltage	± 0.02	$\%/^\circ\text{C}$

Thermal Characteristics

Values are at $T_A = 25^\circ\text{C}$ unless otherwise noted.

Symbol	Parameter	Value	Units
P_D	Power Dissipation	Internally Limited	W
$R_{\theta JA}$	Thermal Resistance, Junction to Ambient	80	$^\circ\text{C}/\text{W}$
$R_{\theta JC}$	Thermal Resistance, Junction to Case	5	$^\circ\text{C}/\text{W}$

Electrical Characteristics

$V_I - V_O = 5\text{ V}$, $I_O = 0.5\text{ A}$, $0^\circ\text{C} \leq T_J \leq +125^\circ\text{C}$, $I_{MAX} = 1.5\text{ A}$, $P_{DMAX} = 20\text{ W}$, unless otherwise specified.

Symbol	Parameter	Conditions	Min.	Typ.	Max.	Unit	
R_{LINE}	Line Regulation ⁽¹⁾	$T_A = +25^\circ\text{C}$, $3\text{ V} \leq V_I - V_O \leq 40\text{ V}$		0.01	0.04	% / V	
		$3\text{ V} \leq V_I - V_O \leq 40\text{ V}$		0.02	0.07		
R_{LOAD}	Load Regulation ⁽¹⁾	$T_A = +25^\circ\text{C}$, $10\text{ mA} \leq I_O \leq I_{MAX}$	$V_O < 5\text{ V}$		18	25	mV
			$V_O \geq 5\text{ V}$		0.4	0.5	% / V_O
		$10\text{ mA} \leq I_O \leq I_{MAX}$	$V_O < 5\text{ V}$		40	70	mV
			$V_O \geq 5\text{ V}$		0.8	1.5	% / V_O
I_{ADJ}	Adjustable Pin Current			46	100	μA	
ΔI_{ADJ}	Adjustable Pin Current Change	$3\text{ V} \leq V_I - V_O \leq 40\text{ V}$, $10\text{ mA} \leq I_O \leq I_{MAX}$, $P_D \leq P_{MAX}$		2.0	5.0	μA	
V_{REF}	Reference Voltage	$3\text{ V} \leq V_{IN} - V_O \leq 40\text{ V}$, $10\text{ mA} \leq I_O \leq I_{MAX}$, $P_D \leq P_{MAX}$	1.20	1.25	1.30	V	
ST_T	Temperature Stability			0.7		% / V_O	
$I_{L(MIN)}$	Minimum Load Current to Maintain Regulation	$V_I - V_O = 40\text{ V}$		3.5	12.0	mA	
$I_{O(MAX)}$	Maximum Output Current	$T_A = 25^\circ\text{C}$	$V_I - V_O \leq 15\text{ V}$, $P_D \leq P_{MAX}$	1.5	2.2	A	
			$V_I - V_O \leq 40\text{ V}$, $P_D \leq P_{MAX}$		0.3		
e_N	RMS Noise, % of V_{OUT}	$T_A = +25^\circ\text{C}$, $10\text{ Hz} \leq f \leq 10\text{ kHz}$		0.003	0.010	% / V_O	
RR	Ripple Rejection ⁽²⁾	$V_O = 10\text{ V}$, $f = 120\text{ Hz}$	without C_{ADJ}		60	dB	
			$C_{ADJ} = 10\text{ }\mu\text{F}$	66	75		
ST	Long-Term Stability, $T_J = T_{HIGH}$	$T_A = +25^\circ\text{C}$ for End Point Measurements, 1000 HR		0.3	1.0	%	

Notes:

- Load and line regulation are specified at constant junction temperature. Change in V_D due to heating effects must be taken into account separately. Pulse testing with low duty is used ($P_{MAX} = 20\text{ W}$).
- C_{ADJ} , when used, is connected between the adjustment pin and ground.

Typical Performance Characteristics

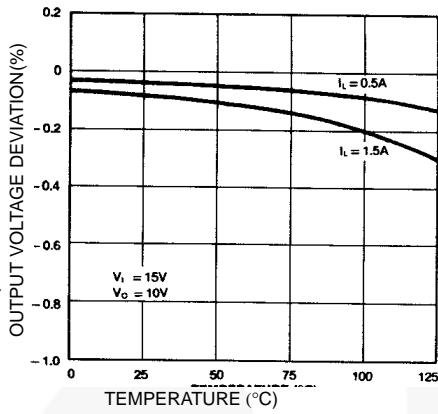

Figure 2. Load Regulation

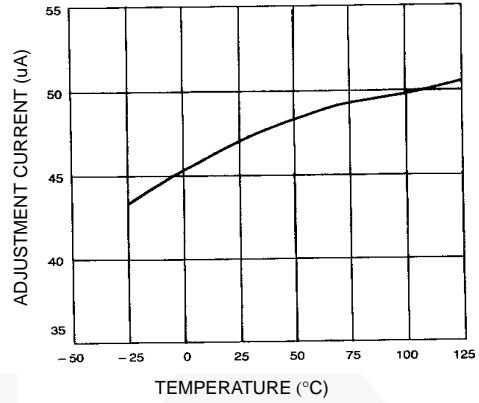

Figure 3. Adjustment Current

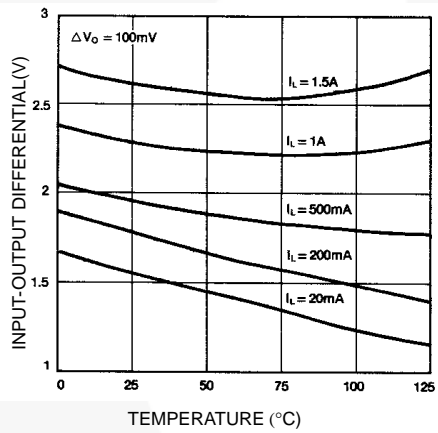

Figure 4. Drop out Voltage

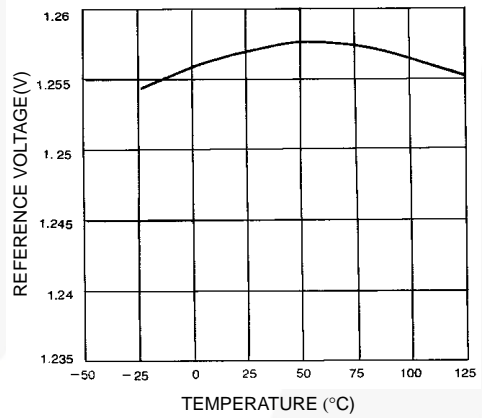

Figure 5. Reference Voltage

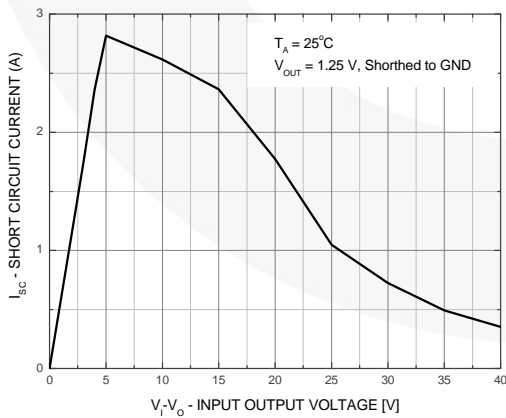
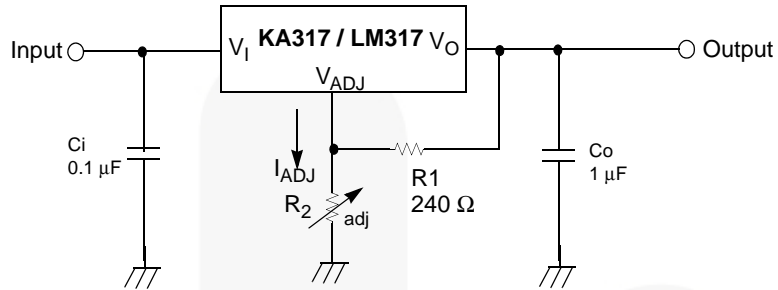

Figure 6. Short Circuit vs. Input-Output Voltage

Typical Application⁽³⁾



$$V_O = 1.25 \text{ V} \left(1 + \frac{R_2}{R_1} \right) + I_{ADJ} R_2$$

Figure 7. Typical Application

Note:

3. C_i is required when the regulator is located an appreciable distance from power supply filter. C_o is not needed for stability; however, it does improve transient response. Since I_{ADJ} is controlled to less than 100 μA , the error associated with this term is negligible in most applications.



Physical Dimensions

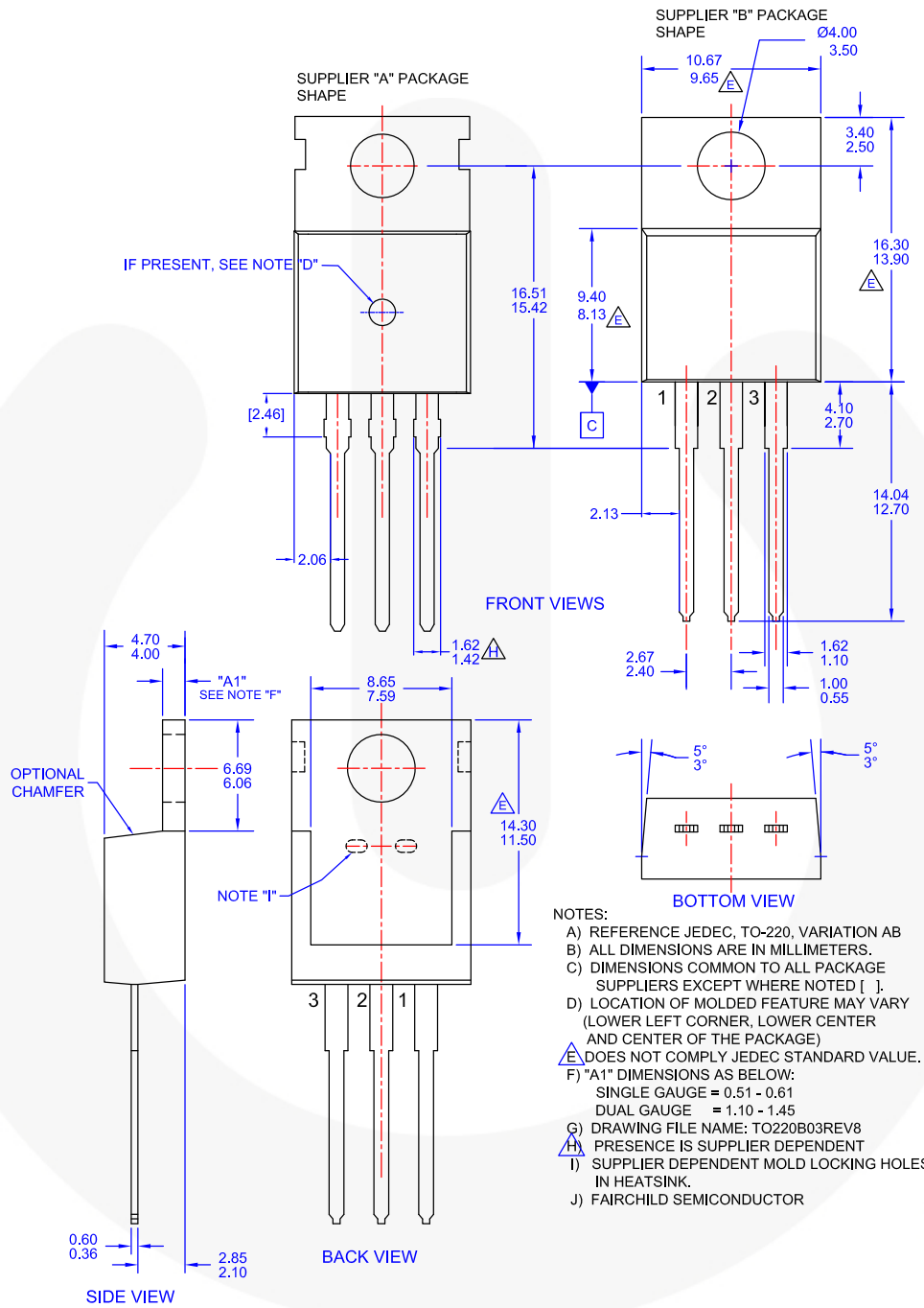

Figure 8. TO-220, MOLDED, 3LEAD, JEDEC VARIATION AB



TRADEMARKS

The following includes registered and unregistered trademarks and service marks, owned by Fairchild Semiconductor and/or its global subsidiaries, and is not intended to be an exhaustive list of all such trademarks.

AccuPower™	F-PFST™		
Awinda®	FRFET®	PowerTrench®	TinyBoost®
AX-CAP®*	Global Power Resource SM	PowerXS™	TinyBuck®
BitSiC™	GreenBridge™	Programmable Active Droop™	TinyCalc™
Build it Now™	Green FPS™	QFET®	TinyLogic®
CorePLUS™	Green FPS™ e-Series™	QS™	TINYOPTO™
CorePOWER™	Gmax™	Quiet Series™	TinyPower™
CROSSVOLT™	GTO™	RapidConfigure™	TinyPWM™
CTL™	IntelliMAX™		TinyWire™
Current Transfer Logic™	ISOPLANAR™	Saving our world, 1mW/W/kW at a time™	TranSiC™
DEUXPEED®	Making Small Speakers Sound Louder and Better™	SignalWise™	TriFault Detect™
Dual Cool™	MegaBuck™	SmartMax™	TRUECURRENT®*
EcoSPARK®	MICROCOUPLER™	SMART START™	µSerDes™
EfficientMax™	MicroFET™	Solutions for Your Success™	
ESBC™	MicroPak™	SPM®	UHC®
	MicroPak2™	STEALTH™	Ultra FRFET™
Fairchild®	MillerDrive™	SuperFET®	UniFET™
Fairchild Semiconductor®	MotionMax™	SuperSOT™-3	VCX™
FACT Quiet Series™	MotionGrid®	SuperSOT™-6	VisualMax™
FACT®	MTI®	SuperSOT™-8	VoltagePlus™
FAST®	MTx®	SupreMOS®	XS™
FastvCore™	MVN®	SyncFET™	Xsens™
FETBench™	mWSaver®	Sync-Lock™	仙童™
FPS™	OptoHiT™		

* Trademarks of System General Corporation, used under license by Fairchild Semiconductor.

DISCLAIMER

FAIRCHILD SEMICONDUCTOR RESERVES THE RIGHT TO MAKE CHANGES WITHOUT FURTHER NOTICE TO ANY PRODUCTS HEREIN TO IMPROVE RELIABILITY, FUNCTION, OR DESIGN. TO OBTAIN THE LATEST, MOST UP-TO-DATE DATASHEET AND PRODUCT INFORMATION, VISIT OUR WEBSITE AT [HTTP://WWW.FAIRCHILDSEMI.COM](http://www.fairchildsemi.com). FAIRCHILD DOES NOT ASSUME ANY LIABILITY ARISING OUT OF THE APPLICATION OR USE OF ANY PRODUCT OR CIRCUIT DESCRIBED HEREIN; NEITHER DOES IT CONVEY ANY LICENSE UNDER ITS PATENT RIGHTS, NOR THE RIGHTS OF OTHERS. THESE SPECIFICATIONS DO NOT EXPAND THE TERMS OF FAIRCHILD'S WORLDWIDE TERMS AND CONDITIONS, SPECIFICALLY THE WARRANTY THEREIN, WHICH COVERS THESE PRODUCTS.

LIFE SUPPORT POLICY

FAIRCHILD'S PRODUCTS ARE NOT AUTHORIZED FOR USE AS CRITICAL COMPONENTS IN LIFE SUPPORT DEVICES OR SYSTEMS WITHOUT THE EXPRESS WRITTEN APPROVAL OF FAIRCHILD SEMICONDUCTOR CORPORATION.

As used herein:

1. Life support devices or systems are devices or systems which, (a) are intended for surgical implant into the body or (b) support or sustain life, and (c) whose failure to perform when properly used in accordance with instructions for use provided in the labeling, can be reasonably expected to result in a significant injury of the user.
2. A critical component in any component of a life support, device, or system whose failure to perform can be reasonably expected to cause the failure of the life support device or system, or to affect its safety or effectiveness.

ANTI-COUNTERFEITING POLICY

Fairchild Semiconductor Corporation's Anti-Counterfeiting Policy. Fairchild's Anti-Counterfeiting Policy is also stated on our external website, www.fairchildsemi.com, under Sales Support.

Counterfeiting of semiconductor parts is a growing problem in the industry. All manufacturers of semiconductor products are experiencing counterfeiting of their parts. Customers who inadvertently purchase counterfeit parts experience many problems such as loss of brand reputation, substandard performance, failed applications, and increased cost of production and manufacturing delays. Fairchild is taking strong measures to protect ourselves and our customers from the proliferation of counterfeit parts. Fairchild strongly encourages customers to purchase Fairchild parts either directly from Fairchild or from Authorized Fairchild Distributors who are listed by country on our web page cited above. Products customers buy either from Fairchild directly or from Authorized Fairchild Distributors are genuine parts, have full traceability, meet Fairchild's quality standards for handling and storage and provide access to Fairchild's full range of up-to-date technical and product information. Fairchild and our Authorized Distributors will stand behind all warranties and will appropriately address any warranty issues that may arise. Fairchild will not provide any warranty coverage or other assistance for parts bought from Unauthorized Sources. Fairchild is committed to combat this global problem and encourage our customers to do their part in stopping this practice by buying direct or from authorized distributors.

PRODUCT STATUS DEFINITIONS

Definition of Terms

Datasheet Identification	Product Status	Definition
Advance Information	Formative / In Design	Datasheet contains the design specifications for product development. Specifications may change in any manner without notice.
Preliminary	First Production	Datasheet contains preliminary data; supplementary data will be published at a later date. Fairchild Semiconductor reserves the right to make changes at any time without notice to improve design.
No Identification Needed	Full Production	Datasheet contains final specifications. Fairchild Semiconductor reserves the right to make changes at any time without notice to improve the design.
Obsolete	Not In Production	Datasheet contains specifications on a product that is discontinued by Fairchild Semiconductor. The datasheet is for reference information only.

ON Semiconductor and  are trademarks of Semiconductor Components Industries, LLC dba ON Semiconductor or its subsidiaries in the United States and/or other countries. ON Semiconductor owns the rights to a number of patents, trademarks, copyrights, trade secrets, and other intellectual property. A listing of ON Semiconductor's product/patent coverage may be accessed at www.onsemi.com/site/pdf/Patent-Marking.pdf. ON Semiconductor reserves the right to make changes without further notice to any products herein. ON Semiconductor makes no warranty, representation or guarantee regarding the suitability of its products for any particular purpose, nor does ON Semiconductor assume any liability arising out of the application or use of any product or circuit, and specifically disclaims any and all liability, including without limitation special, consequential or incidental damages. Buyer is responsible for its products and applications using ON Semiconductor products, including compliance with all laws, regulations and safety requirements or standards, regardless of any support or applications information provided by ON Semiconductor. "Typical" parameters which may be provided in ON Semiconductor data sheets and/or specifications can and do vary in different applications and actual performance may vary over time. All operating parameters, including "Typicals" must be validated for each customer application by customer's technical experts. ON Semiconductor does not convey any license under its patent rights nor the rights of others. ON Semiconductor products are not designed, intended, or authorized for use as a critical component in life support systems or any FDA Class 3 medical devices or medical devices with a same or similar classification in a foreign jurisdiction or any devices intended for implantation in the human body. Should Buyer purchase or use ON Semiconductor products for any such unintended or unauthorized application, Buyer shall indemnify and hold ON Semiconductor and its officers, employees, subsidiaries, affiliates, and distributors harmless against all claims, costs, damages, and expenses, and reasonable attorney fees arising out of, directly or indirectly, any claim of personal injury or death associated with such unintended or unauthorized use, even if such claim alleges that ON Semiconductor was negligent regarding the design or manufacture of the part. ON Semiconductor is an Equal Opportunity/Affirmative Action Employer. This literature is subject to all applicable copyright laws and is not for resale in any manner.

PUBLICATION ORDERING INFORMATION

LITERATURE FULFILLMENT:

Literature Distribution Center for ON Semiconductor
19521 E. 32nd Pkwy, Aurora, Colorado 80011 USA
Phone: 303-675-2175 or 800-344-3860 Toll Free USA/Canada
Fax: 303-675-2176 or 800-344-3867 Toll Free USA/Canada
Email: orderlit@onsemi.com

N. American Technical Support: 800-282-9855 Toll Free
USA/Canada
Europe, Middle East and Africa Technical Support:
Phone: 421 33 790 2910
Japan Customer Focus Center
Phone: 81-3-5817-1050

ON Semiconductor Website: www.onsemi.com
Order Literature: <http://www.onsemi.com/orderlit>
For additional information, please contact your local
Sales Representative