

# LM3643 Synchronous Boost Dual LED Flash Driver with 1.5-A High-Side Current Sources

## 1 Features

- 1.5 A Total Allowed LED Current During Operation ( $I_{LED1} + I_{LED2} = 1.5 \text{ A}$ )
- Dual Independent LED Current Source Programmability
- Accurate and Programmable LED Current Range from 1.4 mA to 1.5 A
- Optimized Flash LED Current During Low Battery Conditions (IVFM)
- > 85% Efficiency in Torch Mode (@ 100 mA) and Flash Mode (@ 1 A to 1.5 A)
- Grounded Cathode LED Operation for Improved Thermal Management
- Small Solution Size: < 16 mm<sup>2</sup>
- Hardware Strobe Enable (STROBE)
- Synchronization Input for RF Power Amplifier Pulse Events (TX)
- Hardware Torch Enable (TORCH/TEMP)
- Remote NTC Monitoring (TORCH/TEMP)
- 400-kHz I<sup>2</sup>C-Compatible Interface
  - LM3643 (I<sup>2</sup>C Address = 0x63)
  - LM3643A (I<sup>2</sup>C Address = 0x67)

## 2 Applications

Camera Phone White LED Flash

## 3 Description

The LM3643 is a dual LED flash driver that provides a high level of adjustability within a small solution size. The LM3643 utilizes a 2-MHz or 4-MHz fixed-frequency synchronous boost converter to provide power to the dual 1.5-A constant current LED sources. The total LED current the LM3643 boost can deliver is 1.5 A ( $I_{LED1} + I_{LED2}$ ). The dual 128 level current sources provide the flexibility to adjust the current ratios between LED1 and LED2 with each driver capable of delivering a maximum of 1.5 A (ex:  $I_{LED1} = 1.5 \text{ A}$  and  $I_{LED2} = \text{OFF}$ ,  $I_{LED1} = \text{OFF}$  and  $I_{LED2} = 1.5 \text{ A}$ , or a current configuration with a current less than 1.5 A,  $I_{LED1} = 950 \text{ mA}$  and  $I_{LED2} = 250 \text{ mA}$ ). An adaptive regulation method ensures the current sources remain in regulation and maximizes efficiency.

Features of the LM3643 are controlled via an I<sup>2</sup>C-compatible interface. These features include: hardware flash and hardware torch pins (STROBE and TORCH/TEMP), a TX interrupt, and an NTC thermistor monitor. The device offers independently programmable currents in each output leg to drive the LEDs in a Flash or Movie Mode (Torch) condition.

The 2-MHz or 4-MHz switching frequency options, overvoltage protection (OVP), and adjustable current limit allow for the use of tiny, low-profile inductors and (10- $\mu\text{F}$ ) ceramic capacitors. The device operates over a  $-40^\circ\text{C}$  to  $85^\circ\text{C}$  ambient temperature range.

### Device Information<sup>(1)</sup>

PART NUMBER	PACKAGE	BODY SIZE (MAX)
LM3643	DSBGA (12)	1.69 mm x 1.31 mm

(1) For all available packages, see the orderable addendum at the end of the datasheet.

## 4 Simplified Schematic

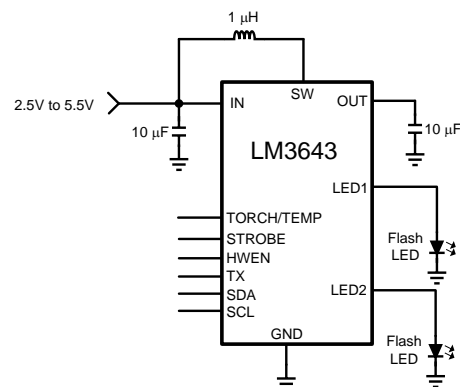

## Table of Contents

<b>1 Features</b> .....	<b>1</b>	9.3 Feature Description .....	<b>12</b>
<b>2 Applications</b> .....	<b>1</b>	9.4 Device Functioning Modes.....	<b>13</b>
<b>3 Description</b> .....	<b>1</b>	9.5 Programming.....	<b>17</b>
<b>4 Simplified Schematic</b> .....	<b>1</b>	9.6 Register Descriptions.....	<b>19</b>
<b>5 Revision History</b> .....	<b>2</b>	<b>10 Applications and Implementation</b> .....	<b>23</b>
<b>6 Device Comparison Table</b> .....	<b>2</b>	10.1 Application Information.....	<b>23</b>
<b>7 Pin Configuration and Functions</b> .....	<b>3</b>	10.2 Typical Application .....	<b>23</b>
<b>8 Specifications</b> .....	<b>4</b>	<b>11 Power Supply Recommendations</b> .....	<b>29</b>
8.1 Absolute Maximum Ratings .....	<b>4</b>	<b>12 Layout</b> .....	<b>29</b>
8.2 Handling Ratings .....	<b>4</b>	12.1 Layout Guidelines .....	<b>29</b>
8.3 Recommended Operating Conditions.....	<b>4</b>	12.2 Layout Example .....	<b>30</b>
8.4 Thermal Information .....	<b>4</b>	<b>13 Device and Documentation Support</b> .....	<b>31</b>
8.5 Electrical Characteristics.....	<b>5</b>	13.1 Device Support.....	<b>31</b>
8.6 Timing Requirements .....	<b>5</b>	13.2 Related Documentation.....	<b>31</b>
8.7 Switching Characteristics .....	<b>5</b>	13.3 Trademarks .....	<b>31</b>
8.8 Typical Characteristics.....	<b>6</b>	13.4 Electrostatic Discharge Caution.....	<b>31</b>
<b>9 Detailed Description</b> .....	<b>10</b>	13.5 Glossary .....	<b>31</b>
9.1 Overview .....	<b>10</b>	<b>14 Mechanical, Packaging, and Orderable</b>	
9.2 Functional Block Diagram .....	<b>11</b>	<b>Information</b> .....	<b>31</b>

## 5 Revision History

Changes from Original (August 2014) to Revision A	Page
• Added Information about LM3643A .....	<b>1</b>
• Changed 0x00 to 0x02 - typo .....	<b>19</b>
• Changed '011' to '000' - typo .....	<b>22</b>

## 6 Device Comparison Table

ORDERING PART NUMBER	I <sup>2</sup> C ADDRESS
LM3643YFFR	0x63
LM3643AYFFR	0x67

## 7 Pin Configuration and Functions

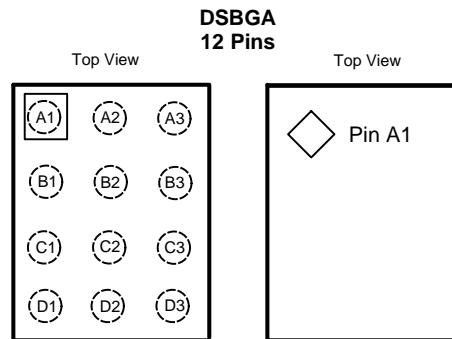

### Pin Functions

PIN		DESCRIPTION
NUMBER	NAME	
A1	GND	Ground
A2	IN	Input voltage connection. Connect IN to the input supply and bypass to GND with a 10- $\mu$ F or larger ceramic capacitor.
A3	SDA	Serial data input/output in the I <sup>2</sup> C Mode on LM3643.
B1	SW	Drain Connection for Internal NMOS and Synchronous PMOS Switches.
B2	STROBE	Active high hardware flash enable. Drive STROBE high to turn on Flash pulse. Internal pulldown resistor of 300 k $\Omega$ between STROBE and GND.
B3	SCL	Serial clock input for LM3643.
C1	OUT	Step-up DC/DC Converter Output. Connect a 10- $\mu$ F ceramic capacitor between this terminal and GND.
C2	HWEN	Active high enable pin. High = Standby, Low = Shutdown/Reset. Internal pulldown resistor of 300 k $\Omega$ between HWEN and GND.
C3	TORCH/TEMP	Torch terminal input or threshold detector for NTC temperature sensing and current scale back.
D1	LED2	High-side current source output for flash LED.
D2	TX	Configurable dual polarity power amplifier synchronization input. Internal pulldown resistor of 300 k $\Omega$ between TX and GND.
D3	LED1	High-side current source output for flash LED.

## 8 Specifications

### 8.1 Absolute Maximum Ratings

 over operating free-air temperature range (unless otherwise noted)<sup>(1)(2)</sup>

	MIN	MAX	UNIT
IN, SW, OUT, LED1, LED2	-0.3	6	V
SDA, SCL, TX, TORCH/TEMP, HWEN, STROBE	-0.3 to the lesser of (V <sub>IN</sub> +0.3) w/ 6 V max		
Continuous power dissipation <sup>(3)</sup>	Internally limited		
Junction temperature (T <sub>J-MAX</sub> )		150	°C
Maximum lead temperature (soldering)	Note <sup>(4)</sup>		

- (1) Stresses beyond those listed under *Absolute Maximum Ratings* may cause permanent damage to the device. These are stress ratings only, which do not imply functional operation of the device at these or any other conditions beyond those indicated under *Recommended Operating Conditions*. Exposure to absolute-maximum-rated conditions for extended periods may affect device reliability.
- (2) All voltages are with respect to the potential at the GND terminal.
- (3) Internal thermal shutdown circuitry protects the device from permanent damage. Thermal shutdown engages at T<sub>J</sub> = 150°C (typ.) and disengages at T<sub>J</sub> = 135°C (typ.). Thermal shutdown is ensured by design.
- (4) For detailed soldering specifications and information, please refer to TI Application Note *DSBGA Wafer Level Chip Scale Package* (SNVA009).

### 8.2 Handling Ratings

	MIN	MAX	UNIT	
T <sub>stg</sub> Storage temperature range	-65	150	°C	
V <sub>(ESD)</sub> Electrostatic discharge	Human body model (HBM), per ANSI/ESDA/JEDEC JS-001, all pins <sup>(1)</sup>	-2500	2500	V
	Charged device model (CDM), per JEDEC specification JESD22-C101, all pins <sup>(2)</sup>	-1500	1500	

- (1) JEDEC document JEP155 states that 500-V HBM allows safe manufacturing with a standard ESD control process.
- (2) JEDEC document JEP157 states that 250-V CDM allows safe manufacturing with a standard ESD control process.

### 8.3 Recommended Operating Conditions

 over operating free-air temperature range (unless otherwise noted)<sup>(1)(2)</sup>

	MIN	MAX	UNIT
V <sub>IN</sub>	2.5	5.5	V
Junction temperature (T <sub>J</sub> )	-40	125	°C
Ambient temperature (T <sub>A</sub> ) <sup>(3)</sup>	-40	85	

- (1) Stresses beyond those listed under *absolute maximum ratings* may cause permanent damage to the device. These are stress ratings only, and functional operation of the device at these or any other conditions beyond those indicated under *recommended operating conditions* is not implied. Exposure to absolute-maximum-rated conditions for extended periods may affect device reliability.
- (2) All voltages are with respect to the potential at the GND terminal.
- (3) In applications where high power dissipation and/or poor package thermal resistance is present, the maximum ambient temperature may have to be derated. Maximum ambient temperature (T<sub>A-MAX</sub>) is dependent on the maximum operating junction temperature (T<sub>J-MAX-OP</sub> = 125°C), the maximum power dissipation of the device in the application (P<sub>D-MAX</sub>), and the junction-to-ambient thermal resistance of the part/package in the application (R<sub>θJA</sub>), as given by the following equation: T<sub>A-MAX</sub> = T<sub>J-MAX-OP</sub> - (R<sub>θJA</sub> × P<sub>D-MAX</sub>).

### 8.4 Thermal Information

THERMAL METRIC <sup>(1)</sup>	LM3643	UNIT
	DSBGA	
	12 PINS	
R <sub>θJA</sub> Junction-to-ambient thermal resistance	67.8	°C/W

- (1) For more information about traditional and new thermal metrics, see the *IC Package Thermal Metrics* application report, [SPRA953](#).

## 8.5 Electrical Characteristics

Typical limits tested at  $T_A = 25^\circ\text{C}$ . Minimum and maximum limits apply over the full operating ambient temperature range ( $-40^\circ\text{C} \leq T_A \leq 85^\circ\text{C}$ ). Unless otherwise specified,  $V_{IN} = 3.6\text{ V}$ ,  $\text{HWEN} = V_{IN}$ .<sup>(1)(2)</sup>

PARAMETER		TEST CONDITIONS		MIN	TYP	MAX	UNIT
<b>CURRENT SOURCE SPECIFICATIONS</b>							
$I_{\text{LED1/2}}$	Current source accuracy	$V_{\text{OUT}} = 4\text{ V}$ , flash code = 0x7F = 1.5 A flash		-7%	1.5	7%	A
		$V_{\text{OUT}} = 4\text{ V}$ , torch code = 0x3F = 89.3 mA torch		-10%	89.3	10%	mA
$V_{\text{HR}}$	LED1 and LED2 current source regulation voltage	$I_{\text{LED1/2}} = 729\text{ mA}$	Flash	290		mV	
		$I_{\text{LED1/2}} = 179\text{ mA}$	Torch	158			
$V_{\text{OVP}}$		ON threshold		4.86	5	5.1	V
		OFF threshold		4.75	4.88	4.99	
<b>STEP-UP DC/DC CONVERTER SPECIFICATIONS</b>							
$R_{\text{PMOS}}$	PMOS switch on-resistance			86		mΩ	
$R_{\text{NMOS}}$	NMOS switch on-resistance			65			
$I_{\text{CL}}$	Switch current limit	Reg 0x07, bit[0] = 0		-12%	1.9	12%	A
		Reg 0x07, bit[0] = 1		-12%	2.8	12%	
$UVLO$	Undervoltage lockout threshold	Falling $V_{\text{IN}}$		-2%	2.5	2%	V
$V_{\text{TRIP}}$	NTC comparator trip threshold	Reg 0x09, bits[3:1] = '100'		-5%	0.6	5%	V
$I_{\text{NTC}}$	NTC current			-6%	50	6%	μA
$V_{\text{IVFM}}$	Input voltage flash monitor trip threshold	Reg 0x02, bits[5:3] = '000'		-3%	2.9	3%	V
$I_{\text{Q}}$	Quiescent supply current	Device not switching pass mode		0.3		0.75	mA
$I_{\text{SD}}$	Shutdown supply current	Device disabled, $\text{HWEN} = 0\text{ V}$ $2.5\text{ V} \leq V_{\text{IN}} \leq 5.5\text{ V}$		0.1		4	μA
$I_{\text{SB}}$	Standby supply current	Device disabled, $\text{HWEN} = 1.8\text{ V}$ $2.5\text{ V} \leq V_{\text{IN}} \leq 5.5\text{ V}$		2.5		10	μA
<b>HWEN, TORCH/TEMP, STROBE, TX VOLTAGE SPECIFICATIONS</b>							
$V_{\text{IL}}$	Input logic low	$2.5\text{ V} \leq V_{\text{IN}} \leq 5.5\text{ V}$		0		0.4	V
$V_{\text{IH}}$	Input logic high			1.2		$V_{\text{IN}}$	
<b>I<sup>2</sup>C-COMPATIBLE INTERFACE SPECIFICATIONS (SCL, SDA)</b>							
$V_{\text{IL}}$	Input logic low	$2.5\text{ V} \leq V_{\text{IN}} \leq 4.2\text{ V}$		0		0.4	V
$V_{\text{IH}}$	Input logic high			1.2		$V_{\text{IN}}$	
$V_{\text{OL}}$	Output logic low	$I_{\text{LOAD}} = 3\text{ mA}$				400	mV

- (1) Minimum (Min) and Maximum (Max) limits are specified by design, test, or statistical analysis. Typical (typ.) numbers are not verified, but do represent the most likely norm. Unless otherwise specified, conditions for typical specifications are:  $V_{\text{IN}} = 3.6\text{ V}$  and  $T_A = 25^\circ\text{C}$ .
- (2) All voltages are with respect to the potential at the GND pin.

## 8.6 Timing Requirements

		MIN	NOM	MAX	UNIT
$t_1$	SCL clock period	2.4			μs
$t_2$	Data in set-up time to SCL high	100			ns
$t_3$	Data out stable After SCL low	0			
$t_4$	SDA low set-up time to SCL Low (start)	100			
$t_5$	SDA high hold time after SCL high (stop)	100			

## 8.7 Switching Characteristics

over operating free-air temperature range (unless otherwise noted)

PARAMETER	TEST CONDITIONS	MIN	TYP	MAX	UNIT	
$f_{\text{SW}}$	Switching frequency	$2.5\text{ V} \leq V_{\text{IN}} \leq 5.5\text{ V}$	-6%	4	6%	MHz

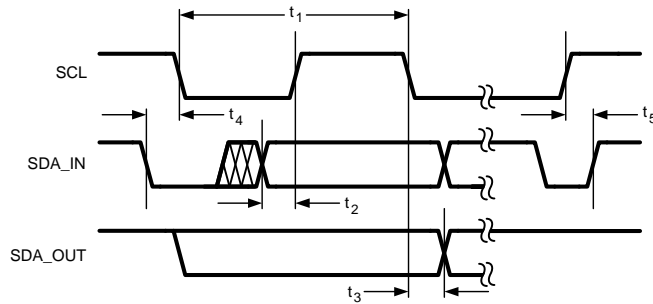

Figure 1. I<sup>2</sup>C-Compatible Interface Specifications

### 8.8 Typical Characteristics

Ambient temperature is 25°C, input voltage is 3.6 V, HWEN = V<sub>IN</sub>, C<sub>IN</sub> = C<sub>OUT</sub> = 2 × 10 μF and L = 1 μH, unless otherwise noted .

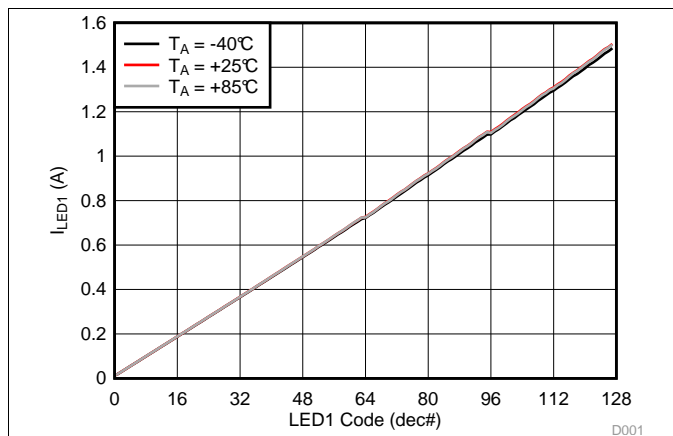

Figure 2. LED1 Flash Current vs Brightness Code

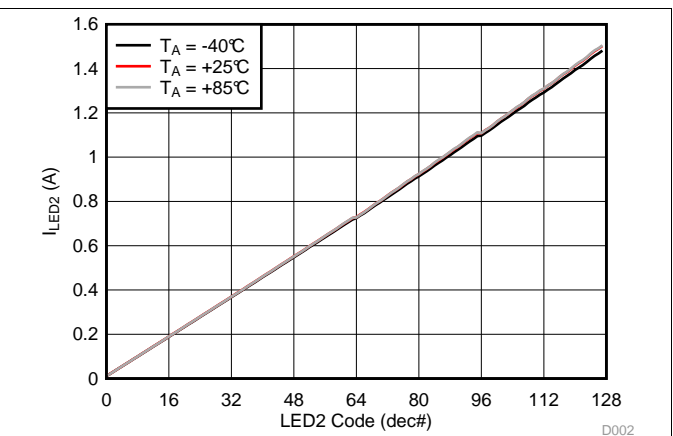

Figure 3. LED2 Flash Current vs Brightness Code

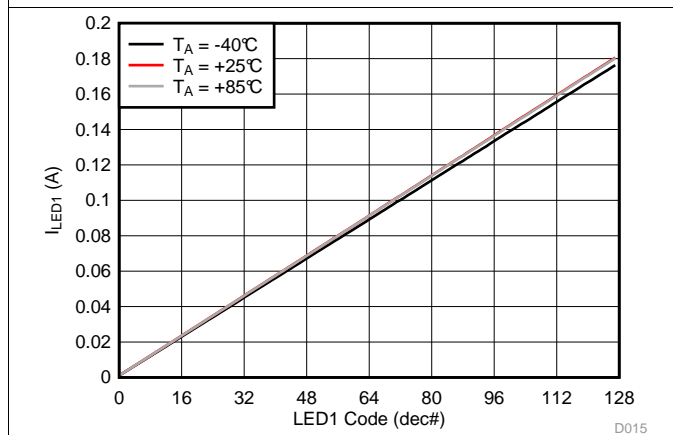

Figure 4. LED1 Torch Current vs Brightness Code

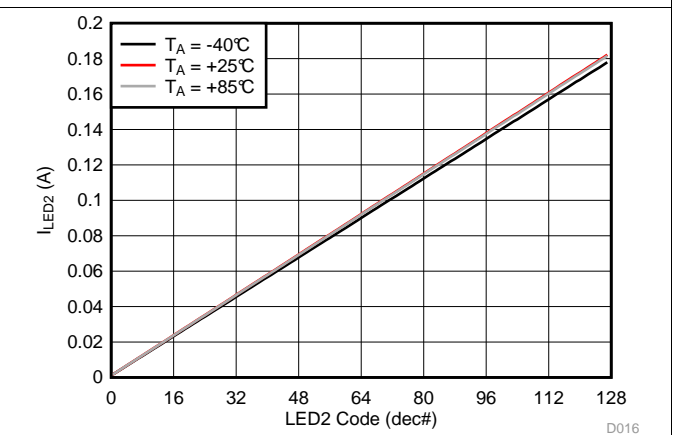
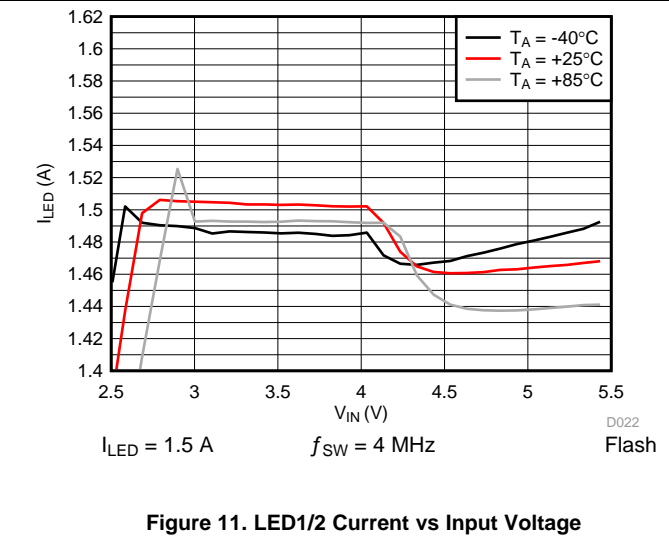
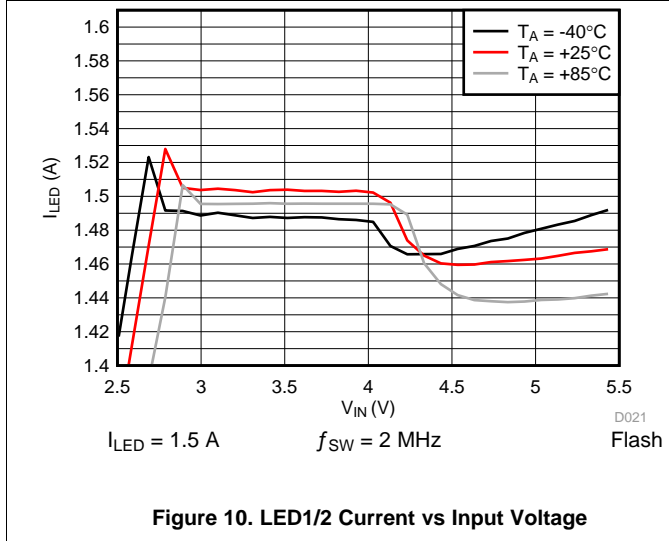
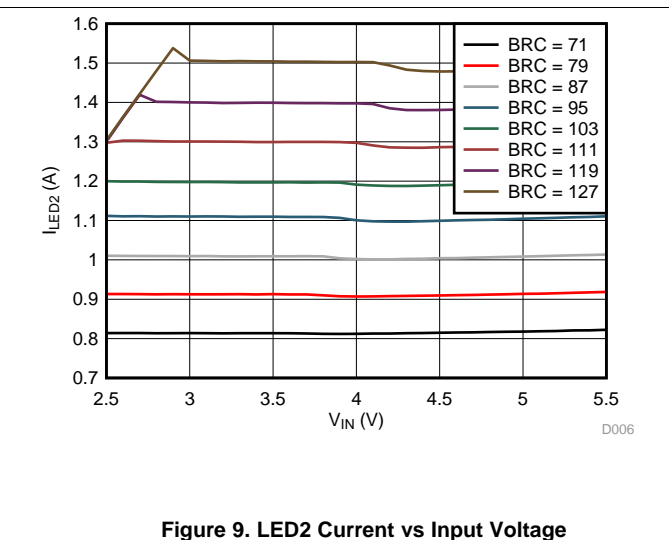
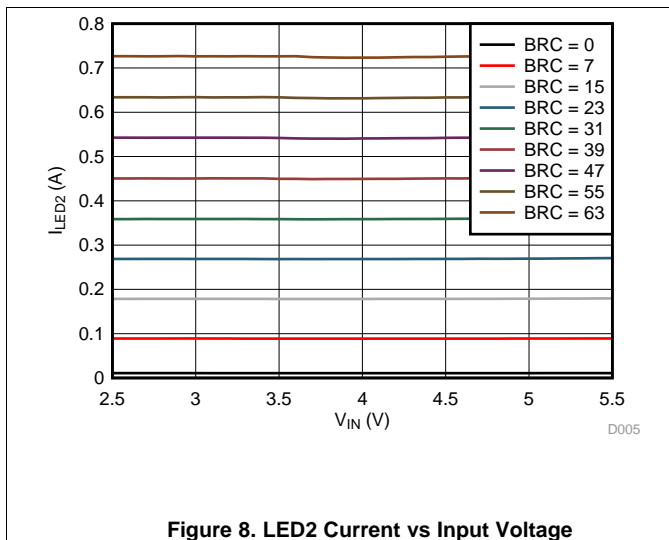
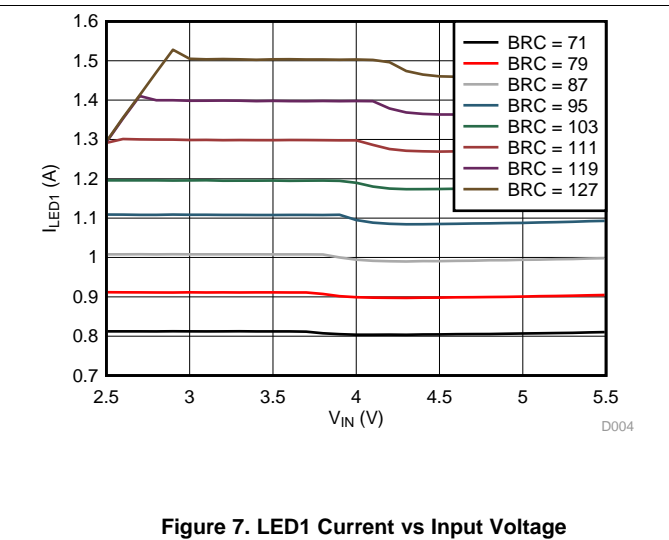
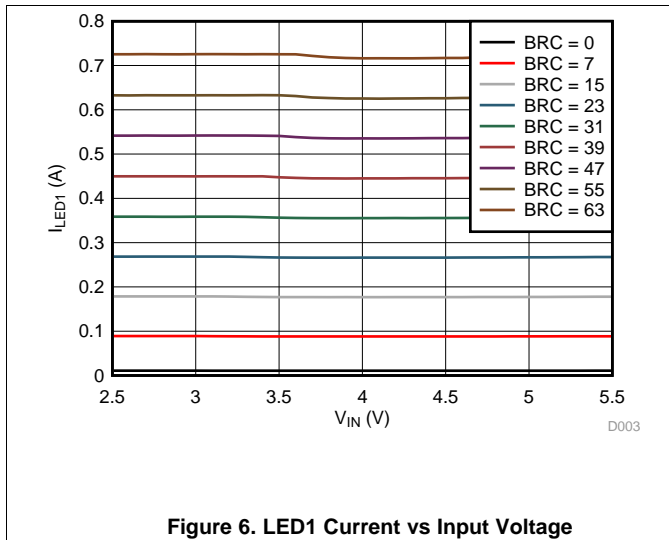

Figure 5. LED2 Torch Current vs Brightness Code

Typical Characteristics (continued)

Ambient temperature is 25°C, input voltage is 3.6 V, HWEN = V<sub>IN</sub>, C<sub>IN</sub> = C<sub>OUT</sub> = 2 × 10 μF and L = 1 μH, unless otherwise noted .



### Typical Characteristics (continued)

Ambient temperature is 25°C, input voltage is 3.6 V, HWEN = V<sub>IN</sub>, C<sub>IN</sub> = C<sub>OUT</sub> = 2 × 10 μF and L = 1 μH, unless otherwise noted.

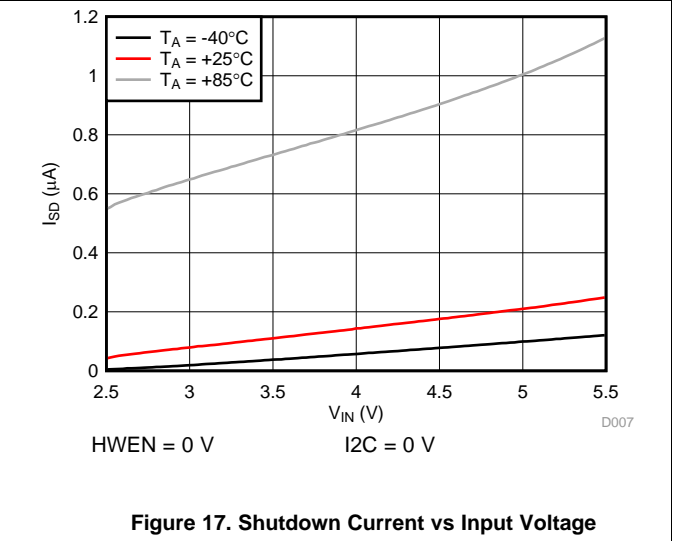
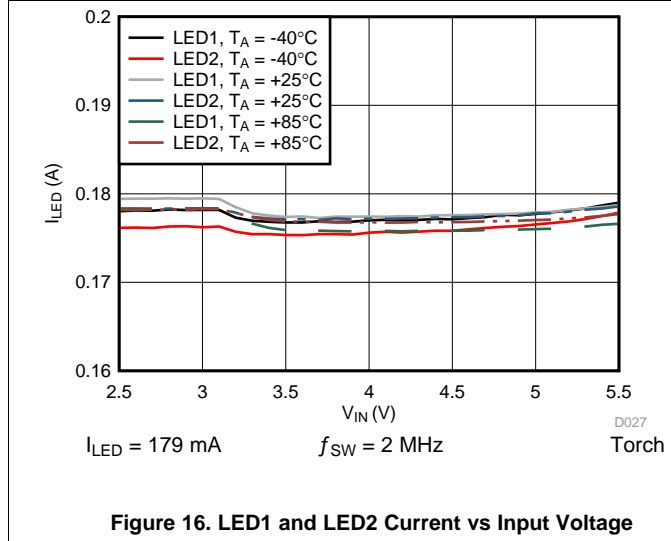
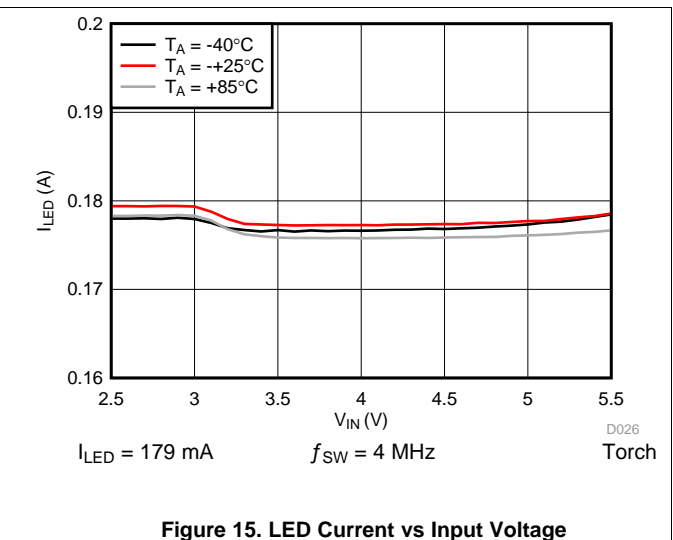
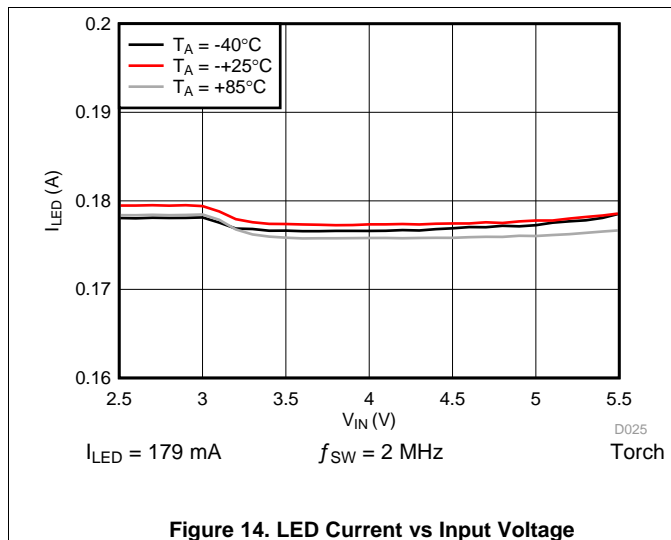
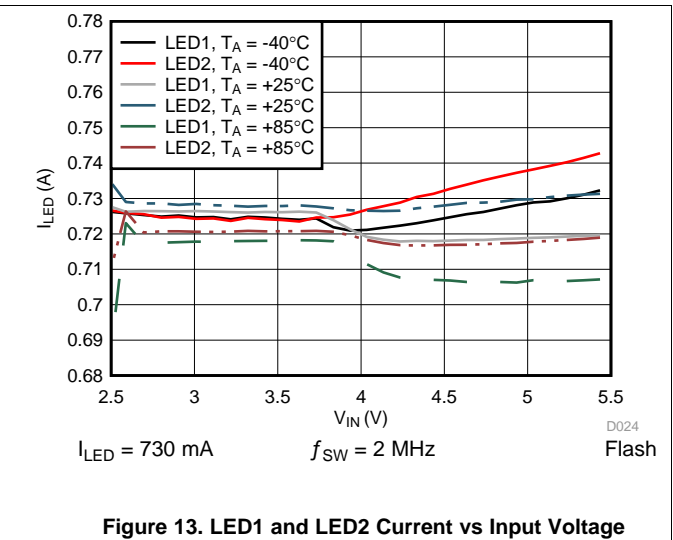
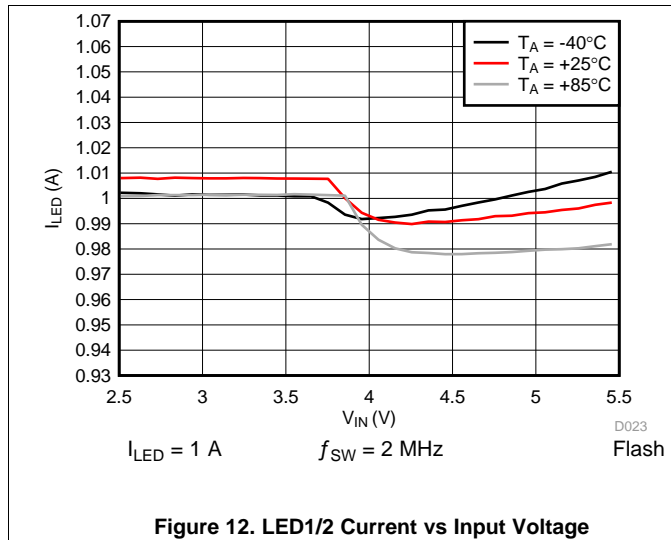



Typical Characteristics (continued)

Ambient temperature is 25°C, input voltage is 3.6 V, HWEN = V<sub>IN</sub>, C<sub>IN</sub> = C<sub>OUT</sub> = 2 × 10 μF and L = 1 μH, unless otherwise noted .

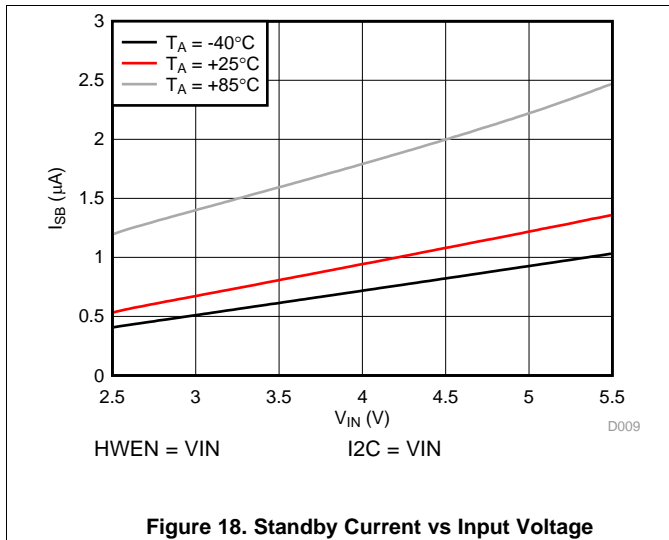

Figure 18. Standby Current vs Input Voltage

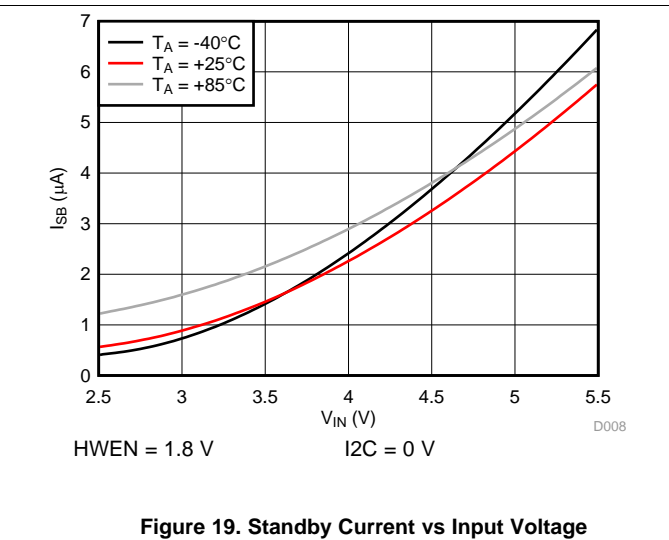

Figure 19. Standby Current vs Input Voltage

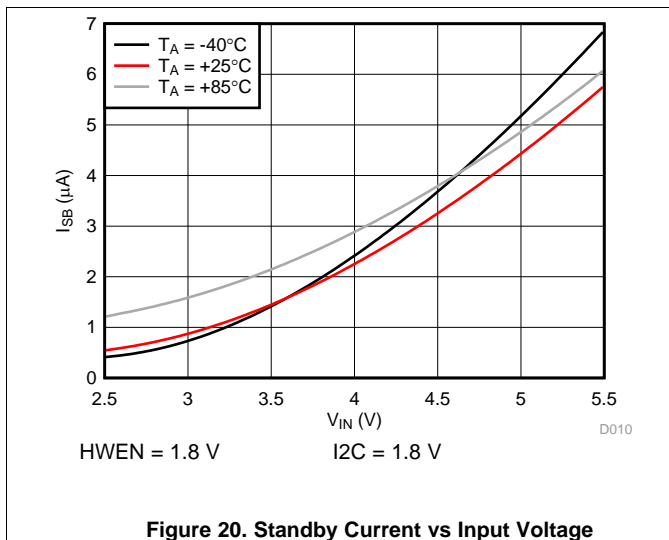

Figure 20. Standby Current vs Input Voltage

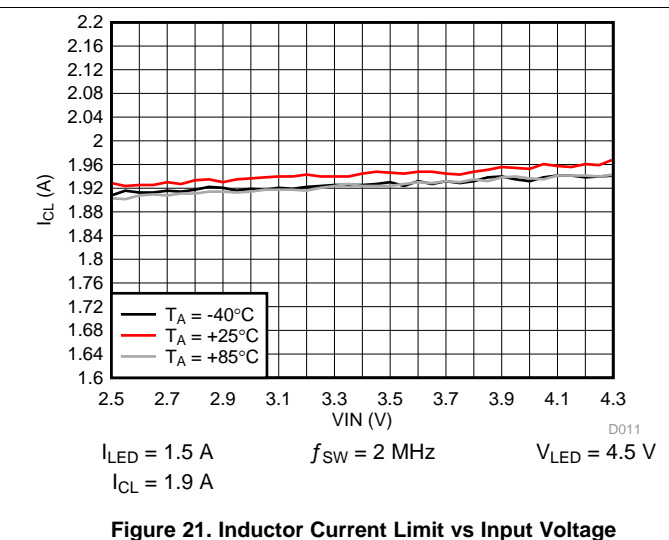

Figure 21. Inductor Current Limit vs Input Voltage

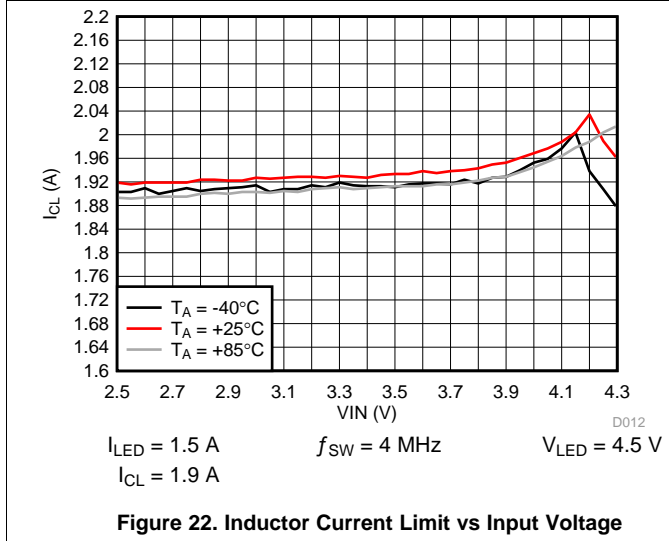

Figure 22. Inductor Current Limit vs Input Voltage

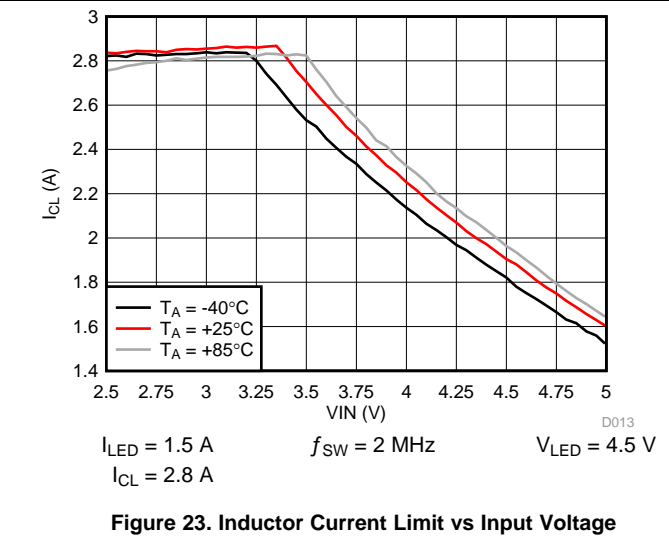
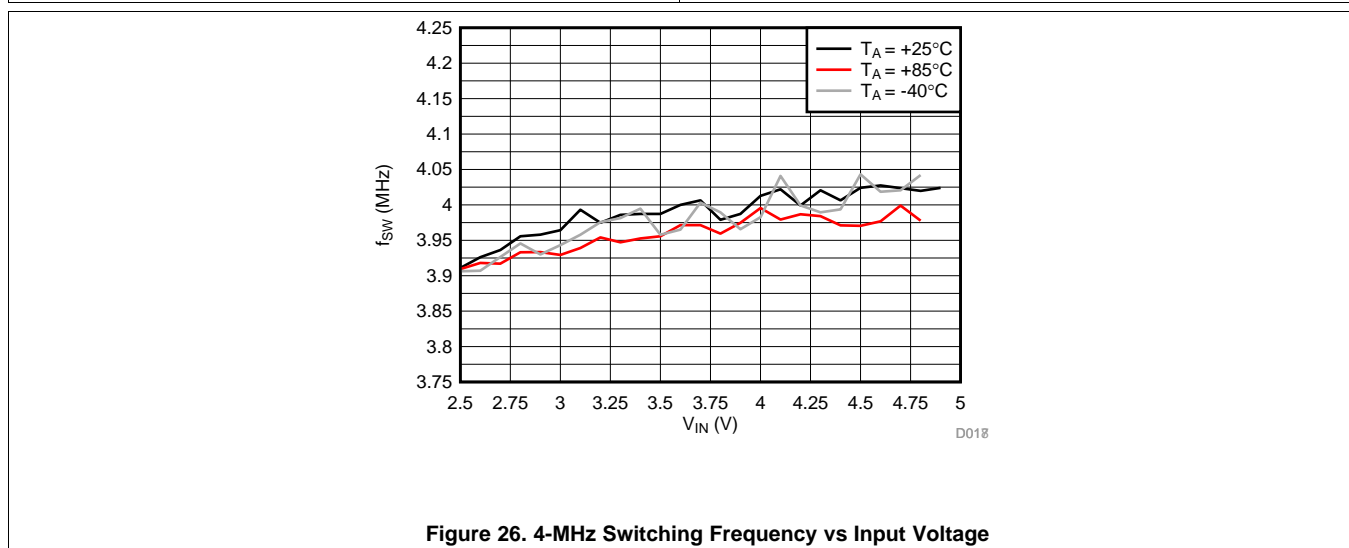
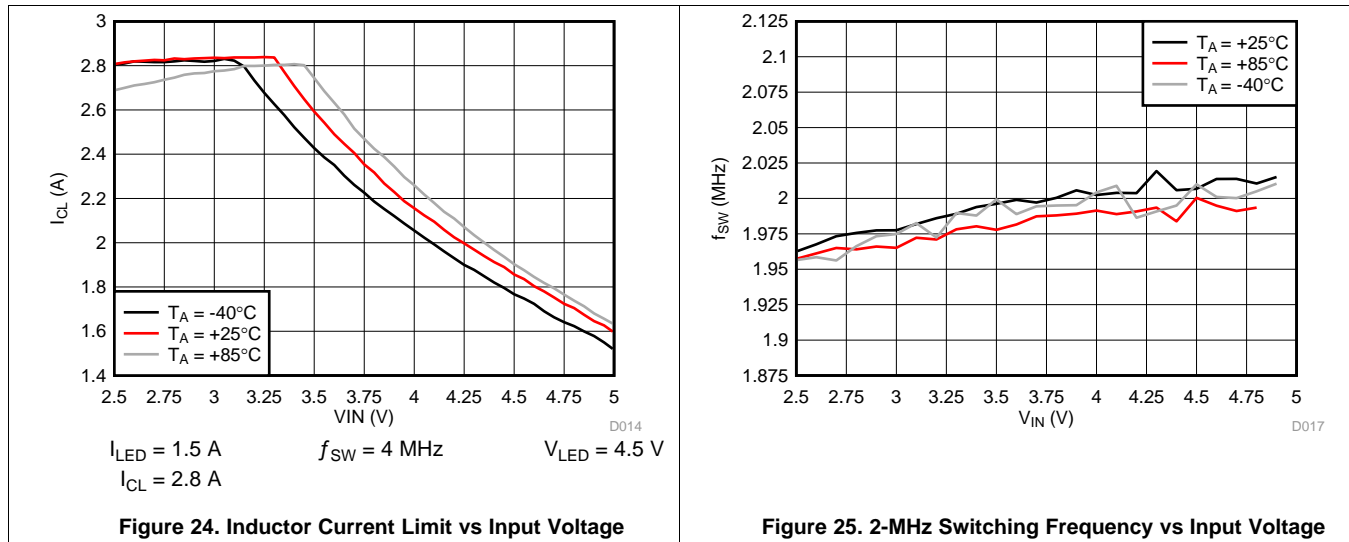

Figure 23. Inductor Current Limit vs Input Voltage

## Typical Characteristics (continued)

Ambient temperature is 25°C, input voltage is 3.6 V, HWEN = V<sub>IN</sub>, C<sub>IN</sub> = C<sub>OUT</sub> = 2 × 10 μF and L = 1 μH, unless otherwise noted .



## 9 Detailed Description

### 9.1 Overview

The LM3643 is a high-power white LED flash driver capable of delivering up to 1.5 A in either of the two parallel LEDs. The total allowed LED current during operation of the LM3643 (I<sub>LED1</sub>+I<sub>LED2</sub>) is 1.5 A. The device incorporates a 2-MHz or 4-MHz constant frequency-synchronous current-mode PWM boost converter and dual high-side current sources to regulate the LED current over the 2.5-V to 5.5-V input voltage range.

The LM3643 PWM DC/DC boost converter switches and boosts the output to maintain at least V<sub>HR</sub> across each of the current sources (LED1/2). This minimum headroom voltage ensures that both current sources remain in regulation. If the input voltage is above the LED voltage + current source headroom voltage the device does not switch, but turns the PFET on continuously (Pass mode). In Pass mode the difference between (V<sub>IN</sub> - I<sub>LED</sub> × R<sub>PMOS</sub>) and the voltage across the LED is dropped across the current source.

## Overview (continued)

The LM3643 has three logic inputs including a hardware Flash Enable (STROBE), a hardware Torch Enable (TORCH/TEMP, TORCH = default), and a Flash Interrupt input (TX) designed to interrupt the flash pulse during high battery-current conditions. These logic inputs have internal 300-k $\Omega$  (typ.) pulldown resistors to GND.

Additional features of the LM3643 include an internal comparator for LED thermal sensing via an external NTC thermistor and an input voltage monitor that can reduce the Flash current during low  $V_{IN}$  conditions. It also has a Hardware Enable (HWEN) pin that can be used to reset the state of the device and the registers by pulling the HWEN pin to ground.

Control is done via an I<sup>2</sup>C-compatible interface. This includes adjustment of the Flash and Torch current levels, changing the Flash Timeout Duration, and changing the switch current limit. Additionally, there are flag and status bits that indicate flash current time-out, LED overtemperature condition, LED failure (open/short), device thermal shutdown, TX interrupt, and  $V_{IN}$  undervoltage conditions.

## 9.2 Functional Block Diagram

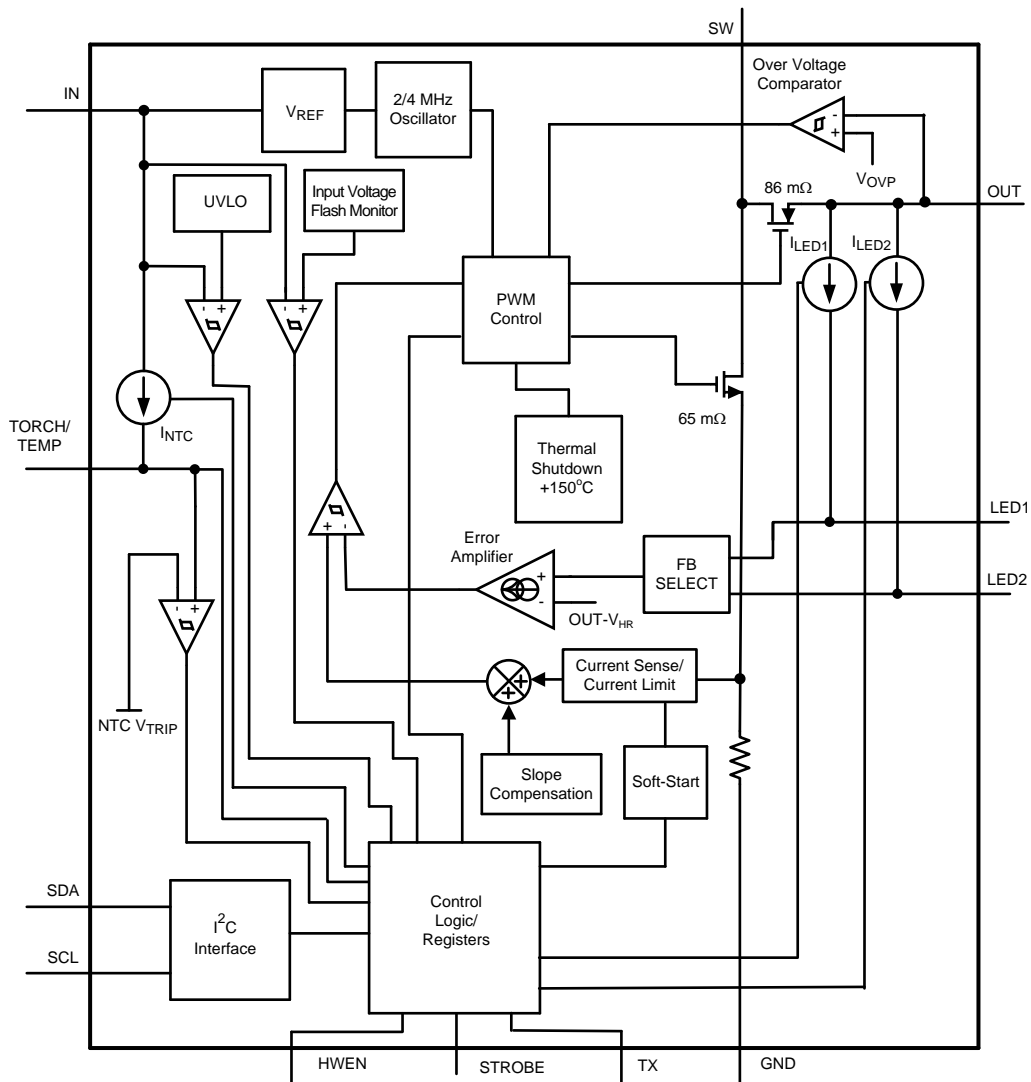

## 9.3 Feature Description

### 9.3.1 Flash Mode

In Flash Mode, the LED current sources (LED1/2) provide 128 target current levels from 10.9 mA to 1500 mA. **The total allowed LED current during operation is 1.5A ( $I_{LED1} + I_{LED2} = 1.5 A$ ).** Once the Flash sequence is activated the current source (LED) ramps up to the programmed Flash current by stepping through all current steps until the programmed current is reached. The headroom in the two current sources can be regulated to provide 10.9 mA to 1.5 A on each of the two output legs. There is an option in the register settings to keep the two currents in the output leg the same.

When the device is enabled in Flash Mode through the Enable Register, all mode bits in the Enable Register are cleared after a flash time-out event.

### 9.3.2 Torch Mode

In Torch mode, the LED current sources (LED1/2) provide 128 target current levels from 0.977 mA to 179 mA. The Torch currents are adjusted via the LED1 and LED2 LED Torch Brightness Registers. Torch mode is activated by the Enable Register (setting M1, M0 to '10'), or by pulling the TORCH/TEMP pin HIGH when the pin is enabled (Enable Register) and set to Torch Mode. Once the TORCH sequence is activated the active current sources (LED1/2) ramps up to the programmed Torch current by stepping through all current steps until the programmed current is reached. The rate at which the current ramps is determined by the value chosen in the Timing Register.

Torch Mode is not affected by Flash Timeout or by a TX Interrupt event.

### 9.3.3 IR Mode

In IR Mode, the target LED current is equal to the value stored in the LED1/2 Flash Brightness Registers. When IR mode is enabled (setting M1, M0 to '01'), the boost converter turns on and set the output equal to the input (pass-mode). At this point, toggling the STROBE pin enables and disables the LED1/2 current sources (if enabled). The strobe pin can only be set to be Level sensitive, meaning all timing of the IR pulse is externally controlled. In IR Mode, the current sources do not ramp the LED outputs to the target. The current transitions immediately from off to on and then on to off.

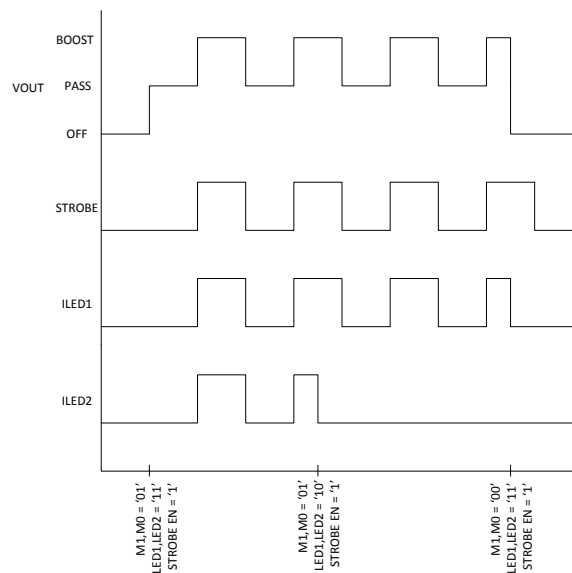

**Figure 27. IR Mode with Boost**

## Feature Description (continued)

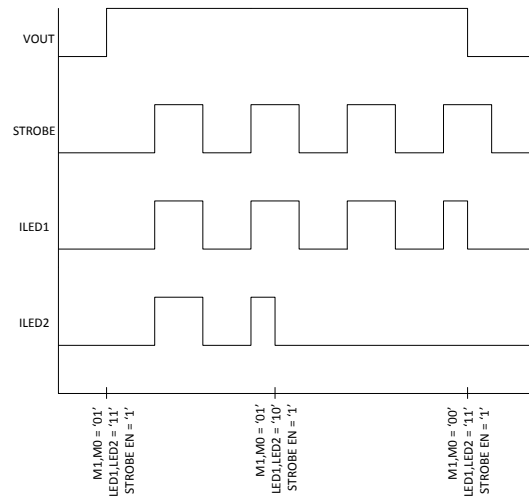

Figure 28. IR Mode Pass Only

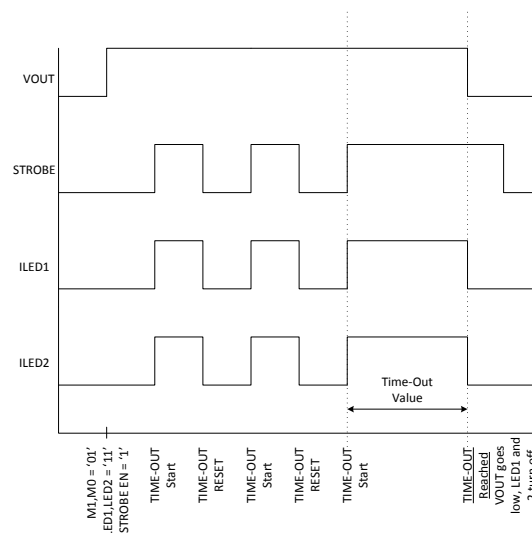

Figure 29. IR Mode Timeout

## 9.4 Device Functioning Modes

### 9.4.1 Start-Up (Enabling The Device)

Turn on of the LM3643 Torch and Flash modes can be done through the Enable Register. On start-up, when  $V_{OUT}$  is less than  $V_{IN}$  the internal synchronous PFET turns on as a current source and delivers 200 mA (typ.) to the output capacitor. During this time the current source (LED) is off. When the voltage across the output capacitor reaches 2.2 V (typ.) the current source turns on. At turnon the current source steps through each FLASH or TORCH level until the target LED current is reached. This gives the device a controlled turnon and limits inrush current from the  $V_{IN}$  supply.

## Device Functioning Modes (continued)

### 9.4.2 Pass Mode

The LM3643 starts up in Pass Mode and stays there until Boost Mode is needed to maintain regulation. If the voltage difference between  $V_{OUT}$  and  $V_{LED}$  falls below  $V_{HR}$ , the device switches to Boost Mode. In Pass Mode the boost converter does not switch, and the synchronous PFET turns fully on bringing  $V_{OUT}$  up to  $V_{IN} - I_{LED} \times R_{PMOS}$ . In Pass Mode the inductor current is not limited by the peak current limit.

### 9.4.3 Power Amplifier Synchronization (TX)

The TX pin is a Power Amplifier Synchronization input. This is designed to reduce the flash LED current and thus limit the battery current during high battery current conditions such as PA transmit events. When the LM3643 is engaged in a Flash event, and the TX pin is pulled high, the LED current is forced into Torch Mode at the programmed Torch current setting. If the TX pin is then pulled low before the Flash pulse terminates, the LED current returns to the previous Flash current level. At the end of the Flash time-out, whether the TX pin is high or low, the LED current turns off.

### 9.4.4 Input Voltage Flash Monitor (IVFM)

The LM3643 has the ability to adjust the flash current based upon the voltage level present at the IN pin utilizing the Input Voltage Flash Monitor (IVFM). The adjustable threshold IVFM-D ranges from 2.9 V to 3.6 V in 100-mV steps, with three different usage modes (Stop and Hold, Adjust Down Only, Adjust Up and Down). The Flags2 Register has the IVFM flag bit set when the input voltage crosses the IVFM-D value. Additionally, the IVFM-D threshold sets the input voltage boundary that forces the LM3643 to either stop ramping the flash current during start-up (Stop and Hold Mode) or to start decreasing the LED current during the flash (Down Adjust Only and Up and Down Adjust). In Adjust Up and Down mode, the IVFM-D value plus the hysteresis voltage threshold set the input voltage boundary that forces the LM3643 to start ramping the flash current back up towards the target.

Device Functioning Modes (continued)

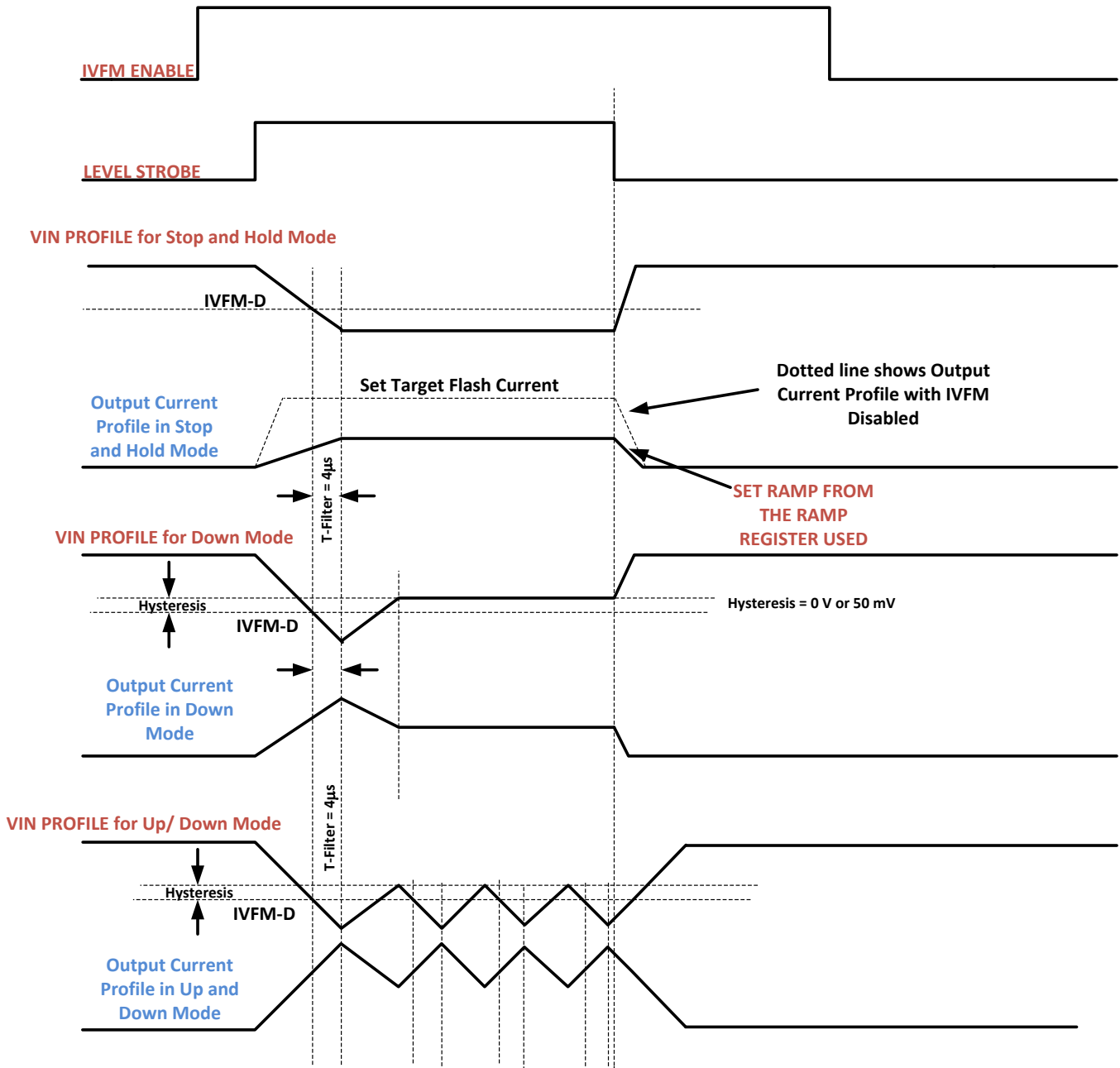

Figure 30. IVFM Modes

## Device Functioning Modes (continued)

### 9.4.5 Fault/Protections

#### 9.4.5.1 Fault Operation

If the LM3643 enters a fault condition, the device sets the appropriate flag in the Flags1 and Flags2 Registers (0x0A and 0x0B), and place the device into standby by clearing the Mode Bits ([1],[0]) in the Enable Register. The LM3643 remains in standby until an I<sup>2</sup>C read of the Flags1 and Flags2 Registers are completed. Upon clearing the flags/faults, the device can be restarted (Flash, Torch, IR, etc.). If the fault is still present, the LM3643 re-enters the fault state and enters standby again.

#### 9.4.5.2 Flash Time-Out

The Flash Time-Out period sets the amount of time that the Flash Current is being sourced from the current sources (LED1/2). The LM3643 has 16 timeout levels ranging from 10 ms to 400 ms (see [Timing Configuration Register \(0x08\)](#) for more detail).

#### 9.4.5.3 Overvoltage Protection (OVP)

The output voltage is limited to typically 5 V (see  $V_{OVP}$  spec in the [Electrical Characteristics](#)). In situations such as an open LED, the LM3643 raises the output voltage in order to try and keep the LED current at its target value. When  $V_{OUT}$  reaches 5 V (typ.) the overvoltage comparator trips and turns off the internal NFET. When  $V_{OUT}$  falls below the “ **$V_{OVP}$  Off Threshold**”, the LM3643 begins switching again. The mode bits are cleared, and the OVP flag is set, when an OVP condition is present for three rising OVP edges. This prevents momentary OVP events from forcing the device to shut down.

#### 9.4.5.4 Current Limit

The LM3643 features two selectable inductor current limits that are programmable through the I<sup>2</sup>C-compatible interface. When the inductor current limit is reached, the LM3643 terminates the charging phase of the switching cycle. Switching resumes at the start of the next switching period. If the overcurrent condition persists, the device operates continuously in current limit.

Since the current limit is sensed in the NMOS switch, there is no mechanism to limit the current when the device operates in Pass Mode (current does not flow through the NMOS in pass mode). In Boost mode or Pass mode if  $V_{OUT}$  falls below 2.3 V, the device stops switching, and the PFET operates as a current source limiting the current to 200 mA. This prevents damage to the LM3643 and excessive current draw from the battery during output short-circuit conditions. The mode bits are not cleared upon a Current Limit event, but a flag is set.

#### 9.4.5.5 NTC Thermistor Input (Torch/Temp)

The TORCH/TEMP pin, when set to TEMP mode, serves as a threshold detector and bias source for negative temperature coefficient (NTC) thermistors. When the voltage at TEMP goes below the programmed threshold, the LM3643 is placed into standby mode. The NTC threshold voltage is adjustable from 200 mV to 900 mV in 100-mV steps. The NTC bias current is set to 50  $\mu$ A. The NTC detection circuitry can be enabled or disabled via the Enable Register. If enabled, the NTC block turns on and off during the start and stop of a Flash/Torch event.

Additionally, the NTC input looks for an open NTC connection and a shorted NTC connection. If the NTC input falls below 100 mV, the NTC short flag is set, and the device is disabled. If the NTC input rises above 2.3 V, the NTC Open flag is set, and the device is disabled. These fault detections can be individually disabled/enabled via the NTC Open Fault Enable bit and the NTC Short Fault Enable bit.

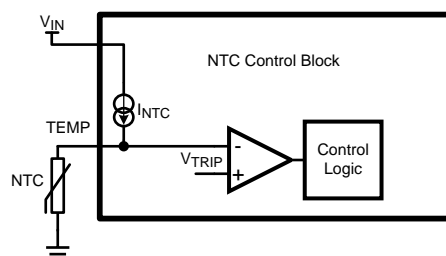

**Figure 31. Temp Detection Diagram**



## Device Functioning Modes (continued)

### 9.4.5.6 Undervoltage Lockout (UVLO)

The LM3643 has an internal comparator that monitors the voltage at IN and forces the LM3643 into standby if the input voltage drops to 2.5 V. If the UVLO monitor threshold is tripped, the UVLO flag bit is set in the Flags1 Register (0x0A). If the input voltage rises above 2.5 V, the LM3643 is not available for operation until there is an I<sup>2</sup>C read of the Flags1 Register (0x0A). Upon a read, the Flags1 register is cleared, and normal operation can resume if the input voltage is greater than 2.5 V.

### 9.4.5.7 Thermal Shutdown (TSD)

When the LM3643 die temperature reaches 150°C, the thermal shutdown detection circuit trips, forcing the LM3643 into standby and writing a '1' to the corresponding bit of the Flags1 Register (0x0A) (Thermal Shutdown bit). The LM3643 is only allowed to restart after the Flags1 Register (0x0A) is read, clearing the fault flag. Upon restart, if the die temperature is still above 150°C, the LM3643 resets the Fault flag and re-enters standby.

### 9.4.5.8 LED and/or V<sub>OUT</sub> Short Fault

The LED Fault flags read back a '1' if the device is active in Flash or Torch mode and either active LED output experiences a short condition. The Output Short Fault flag reads back a '1' if the device is active in Flash or Torch mode and the boost output experiences a short condition. An LED short condition is determined if the voltage at LED1 or LED2 goes below 500 mV (typ.) while the device is in Torch or Flash mode. There is a deglitch time of 256 μs before the LED Short flag is valid and a deglitch time of 2.048 ms before the V<sub>OUT</sub> Short flag is valid. The LED Short Faults can be reset to '0' by removing power to the LM3643, setting HWEN to '0', setting the SW RESET bit to a '1', or by reading back the Flags1 Register (0x0A on LM3643). The mode bits are cleared upon an LED and/or V<sub>OUT</sub> short fault.

## 9.5 Programming

### 9.5.1 Control Truth Table

MODE1	MODE0	STROBE EN	TORCH EN	STROBE PIN	TORCH PIN	ACTION
0	0	0	0	X	X	Standby
0	0	0	1	X	pos edge	Ext Torch
0	0	1	0	pos edge	X	Ext Flash
0	0	1	1	0	pos edge	Standalone Torch
0	0	1	1	pos edge	0	Standalone Flash
0	0	1	1	pos edge	pos edge	Standalone Flash
1	0	X	X	X	X	Int Torch
1	1	X	X	X	X	Int Flash
0	1	0	X	X	X	IRLED Standby
0	1	1	X	0	X	IRLED Standby
0	1	1	X	pos edge	X	IRLED enabled

### 9.5.2 I<sup>2</sup>C-Compatible Interface

#### 9.5.2.1 Data Validity

The data on SDA must be stable during the HIGH period of the clock signal (SCL). In other words, the state of the data line can only be changed when SCL is LOW.

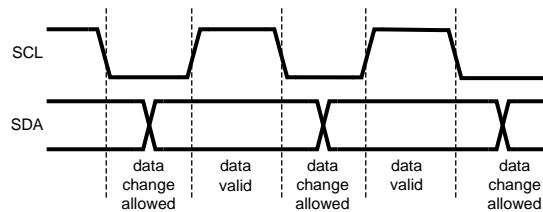
**Figure 32. Data Validity Data**

A pullup resistor between the controller's VIO line and SDA must be greater than  $[(VIO - V_{OL}) / 3mA]$  to meet the  $V_{OL}$  requirement on SDA. Using a larger pullup resistor results in lower switching current with slower edges, while using a smaller pullup results in higher switching currents with faster edges.

### 9.5.2.2 Start and Stop Conditions

START and STOP conditions classify the beginning and the end of the I<sup>2</sup>C session. A START condition is defined as the SDA signal transitioning from HIGH to LOW while SCL line is HIGH. A STOP condition is defined as the SDA transitioning from LOW to HIGH while SCL is HIGH. The I<sup>2</sup>C master always generates START and STOP conditions. The I<sup>2</sup>C bus is considered busy after a START condition and free after a STOP condition. During data transmission, the I<sup>2</sup>C master can generate repeated START conditions. First START and repeated START conditions are equivalent, function-wise.

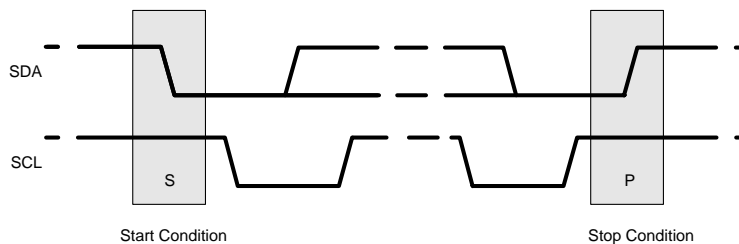
**Figure 33. Start and Stop Conditions**

### 9.5.2.3 Transferring Data

Every byte put on the SDA line must be eight bits long, with the most significant bit (MSB) transferred first. Each byte of data has to be followed by an acknowledge bit. The acknowledge related clock pulse is generated by the master. The master releases the SDA line (HIGH) during the acknowledge clock pulse. The LM3643 pulls down the SDA line during the 9th clock pulse, signifying an acknowledge. The LM3643 generates an acknowledge after each byte is received. There is no acknowledge created after data is read from the device.

After the START condition, the I<sup>2</sup>C master sends a chip address. This address is seven bits long followed by an eighth bit which is a data direction bit (R/W). The LM3643 7-bit address is 0x63. The device address for the LM3643A is 0x67. For the eighth bit, a '0' indicates a WRITE and a '1' indicates a READ. The second byte selects the register to which the data is written. The third byte contains data to write to the selected register.

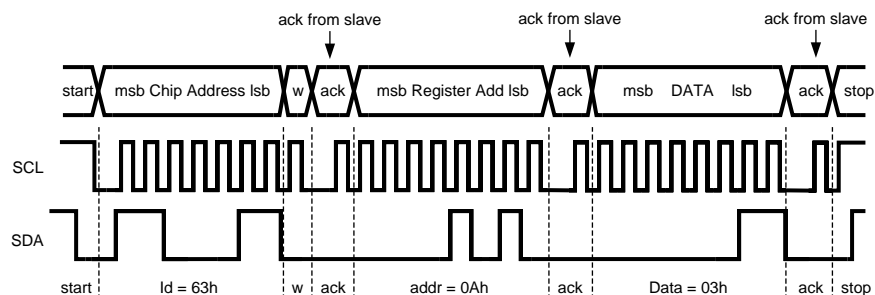
**Figure 34. Write Cycle W = Write (SDA = "0") R = Read (SDA = "1") Ack = Acknowledge (SDA Pulled Down by Either Master or Slave) ID = Chip Address, 63h for LM3643**

### 9.5.2.4 I<sup>2</sup>C-Compatible Chip Address

The device address for the LM3643 is 1100011 (0x63). The device address for the LM3643A is 1100111 (0x67). After the START condition, the I<sup>2</sup>C-compatible master sends the 7-bit address followed by an eighth read or write bit (R/W). R/W = 0 indicates a WRITE and R/W = 1 indicates a READ. The second byte following the device address selects the register address to which the data is written. The third byte contains the data for the selected register.

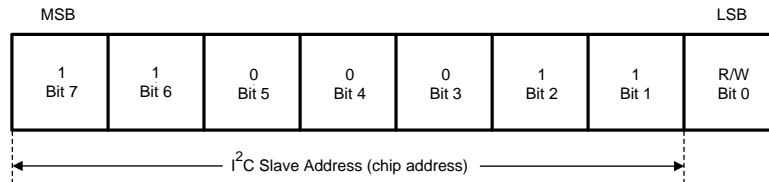

**Figure 35. I<sup>2</sup>C-Compatible Chip Address**

## 9.6 Register Descriptions

REGISTER NAME	INTERNAL HEX ADDRESS	POWER ON/RESET VALUE
		LM3643
Enable Register	0x01	0x80
IVFM Register	0x02	0x01
LED1 Flash Brightness Register	0x03	0xBF
LED2 Flash Brightness Register	0x04	0x3F
LED1 Torch Brightness Register	0x05	0xBF
LED2 Torch Brightness Register	0x06	0x3F
Boost Configuration Register	0x07	0x09
Timing Configuration Register	0x08	0x1A
TEMP Register	0x09	0x08
Flags1 Register	0x0A	0x00
Flags2 Register	0x0B	0x00
Device ID Register	0x0C	0x02
Last Flash Register	0x0D	0x00

### 9.6.1 Enable Register (0x01)

Bit 7	Bit 6	Bit 5	Bit 4	Bit 3	Bit 2	Bit 1	Bit 0
<b>TX Pin Enable</b> 0 = Disabled 1 = Enabled (Default)	<b>Strobe Type</b> 0 = Level Triggered (Default) 1 = Edge Triggered	<b>Strobe Enable</b> 0 = Disabled (Default) 1 = Enabled	<b>TORCH/TEMP Pin Enable</b> 0 = Disabled (Default) 1 = Enabled	<b>Mode Bits: M1, M0</b> '00' = Standby (Default) '01' = IR Drive '10' = Torch '11' = Flash		<b>LED2 Enable</b> 0 = OFF (Default) 1 = ON	<b>LED1 Enable</b> 0 = OFF (Default) 1 = ON

**NOTE**

Edge Strobe Mode is not valid in IR MODE. Switching between Level and Edge Strobe Types while the device is enabled is not recommended.

In Edge or Level Strobe Mode, it is recommended that the trigger pulse width be set greater than 1 ms to ensure proper turn-on of the device.

### 9.6.2 IVFM Register (0x02)

Bit 7	Bit 6	Bit 5	Bit 4	Bit 3	Bit 2	Bit 1	Bit 0
RFU	<b>UVLO Circuitry (Default)</b> 0 = Disabled (Default) 1 = Enabled	<b>IVFM Levels</b> 000 = 2.9 V (Default) 001 = 3 V 010 = 3.1 V 011 = 3.2 V 100 = 3.3 V 101 = 3.4 V 110 = 3.5 V 111 = 3.6 V			<b>IVFM Hysteresis</b> 0 = 0 mV (Default) 1 = 50 mV	<b>IVFM Selection</b> 00 = Disabled 01 = Stop and Hold Mode (Default) 10 = Down Mode 11 = Up and Down Mode	

#### NOTE

IVFM Mode Bits are static once the LM3643 is enabled in Torch, Flash or IR modes. If the IVFM mode needs to be updated, disable the device and then change the mode bits to the desired state.

### 9.6.3 LED1 Flash Brightness Register (0x03)

Bit 7	Bit 6	Bit 5	Bit 4	Bit 3	Bit 2	Bit 1	Bit 0
<b>LED2 Flash Current Override</b> 0 = LED2 Flash Current is not set to LED1 Flash Current 1 = LED2 Flash Current is set to LED1 Flash Current (Default)	<b>LED1 Flash Brightness Level</b> $I_{FLASH1/2} \text{ (mA)} \approx (\text{Brightness Code} \times 11.725 \text{ mA}) + 10.9 \text{ mA}$ 0000000 = 10.9 mA ..... 0111111 = 729 mA (Default) ..... 1111111 = 1.5 A						

### 9.6.4 LED2 Flash Brightness Register (0x04)

Bit 7	Bit 6	Bit 5	Bit 4	Bit 3	Bit 2	Bit 1	Bit 0
RFU	<b>LED2 Flash Brightness Levels</b> $I_{FLASH1/2} \text{ (mA)} \approx (\text{Brightness Code} \times 11.725 \text{ mA}) + 10.9 \text{ mA}$ 0000000 = 10.9 mA ..... 0111111 = 729 mA (Default) ..... 1111111 = 1.5 A						

### 9.6.5 LED1 Torch Brightness Register (0x05)

Bit 7	Bit 6	Bit 5	Bit 4	Bit 3	Bit 2	Bit 1	Bit 0
<b>LED2 Torch Current Override</b> 0 = LED2 Torch Current is not set to LED1 Torch Current 1 = LED2 Torch Current is set to LED1 Torch Current (Default)	<b>LED1 Torch Brightness Levels</b> $I_{TORCH1/2} \text{ (mA)} \approx (\text{Brightness Code} \times 1.4 \text{ mA}) + 0.977 \text{ mA}$ 0000000 = 0.977 mA ..... 0111111 = 89.3 mA (Default) ..... 1111111 = 179 mA						

**9.6.6 LED2 Torch Brightness Register (0x06)**

Bit 7	Bit 6	Bit 5	Bit 4	Bit 3	Bit 2	Bit 1	Bit 0
RFU	<b>LED2 Torch Brightness Levels</b> $I_{TORCH1/2} \text{ (mA)} \approx (\text{Brightness Code} \times 1.4 \text{ mA}) + 0.977 \text{ mA}$ 0000000 = 0.977 mA ..... 0111111 = 89.3 mA (Default) ..... 1111111 = 179 mA						

**9.6.7 Boost Configuration Register (0x07)**

Bit 7	Bit 6	Bit 5	Bit 4	Bit 3	Bit 2	Bit 1	Bit 0
<b>Software Reset Bit</b> 0 = Not Reset (Default) 1 = Reset	RFU	RFU	RFU	<b>LED Pin Short Fault Detect</b> 0 = Disabled 1 = Enabled (Default)	<b>Boost Mode</b> 0 = Normal (Default) 1 = Pass Mode Only	<b>Boost Frequency Select</b> 0 = 2 MHz (Default) 1 = 4 MHz	<b>Boost Current Limit Setting</b> 0 = 1.9 A 1 = 2.8 A (Default)

**9.6.8 Timing Configuration Register (0x08)**

Bit 7	Bit 6	Bit 5	Bit 4	Bit 3	Bit 2	Bit 1	Bit 0
RFU	<b>Torch Current Ramp Time</b> 000 = No Ramp 001 = 1 ms (Default) 010 = 32 ms 011 = 64 ms 100 = 128 ms 101 = 256 ms 110 = 512 ms 111 = 1024 ms			<b>Flash Time-Out Duration</b> 0000 = 10 ms 0001 = 20 ms 0010 = 30 ms 0011 = 40 ms 0100 = 50 ms 0101 = 60 ms 0110 = 70 ms 0111 = 80 ms 1000 = 90 ms 1001 = 100 ms 1010 = 150 ms (Default) 1011 = 200 ms 1100 = 250 ms 1101 = 300 ms 1110 = 350 ms 1111 = 400 ms			

**9.6.9 TEMP Register (0x09)**

Bit 7	Bit 6	Bit 5	Bit 4	Bit 3	Bit 2	Bit 1	Bit 0
RFU	<b>TORCH Polarity</b> 0 = Active High (Default) 1 = Active Low (Pulldown Resistor Disabled)	<b>NTC Open Fault Enable</b> 0 = Disabled (Default) 1 = Enable	<b>NTC Short Fault Enable</b> 0 = Disabled (Default) 1 = Enable	<b>TEMP Detect Voltage Threshold</b> 000 = 0.2 V 001 = 0.3 V 010 = 0.4 V 011 = 0.5 V 100 = 0.6 V (Default) 101 = 0.7 V 110 = 0.8 V 111 = 0.9 V		<b>TORCH/TEMP Function Select</b> 0 = TORCH (Default) 1 = TEMP	

**NOTE**

The Torch Polarity bit is static once the LM3643 is enabled in Torch, Flash or IR modes. If the Torch Polarity bit needs to be updated, disable the device and then change the Torch Polarity bit to the desired state.

**LM3643, LM3643A**

SNVS967A – AUGUST 2014 – REVISED NOVEMBER 2014

[www.ti.com](http://www.ti.com)
**9.6.10 Flags1 Register (0x0A)**

Bit 7	Bit 6	Bit 5	Bit 4	Bit 3	Bit 2	Bit 1	Bit 0
TX Flag	V <sub>OUT</sub> Short Fault	VLED1 Short Fault	VLED2 Short Fault	Current Limit Flag	Thermal Shutdown (TSD) Fault	UVLO Fault	Flash Time-Out Flag

**9.6.11 Flags2 Register (0x0B)**

Bit 7	Bit 6	Bit 5	Bit 4	Bit 3	Bit 2	Bit 1	Bit 0
RFU	RFU	RFU	NTC Short Fault	NTC Open Fault	IVFM Trip Flag	OVP Fault	TEMP Trip Fault

**9.6.12 Device ID Register (0x0C)**

Bit 7	Bit 6	Bit 5	Bit 4	Bit 3	Bit 2	Bit 1	Bit 0
RFU	RFU	Device ID '000'			Silicon Revision Bit '010'		

**9.6.13 Last Flash Register (0x0D)**

Bit 7	Bit 6	Bit 5	Bit 4	Bit 3	Bit 2	Bit 1	Bit 0
RFU	The value stored is always the last current value the IVFM detection block set. $I_{LED} = I_{FLASH-TARGET} \times ((Code + 1) / 128)$						

## 10 Applications and Implementation

### NOTE

Information in the following applications sections is not part of the TI component specification, and TI does not warrant its accuracy or completeness. TI's customers are responsible for determining suitability of components for their purposes. Customers should validate and test their design implementation to confirm system functionality.

### 10.1 Application Information

The LM3643 can drive two flash LEDs at currents up to 1.5 A per LED. The total LED current the LM3643 boost can deliver is 1.5 A ( $I_{LED1} + I_{LED2}$ ). The 2-MHz/4-MHz DC/DC boost regulator allows for the use of small value discrete external components.

### 10.2 Typical Application

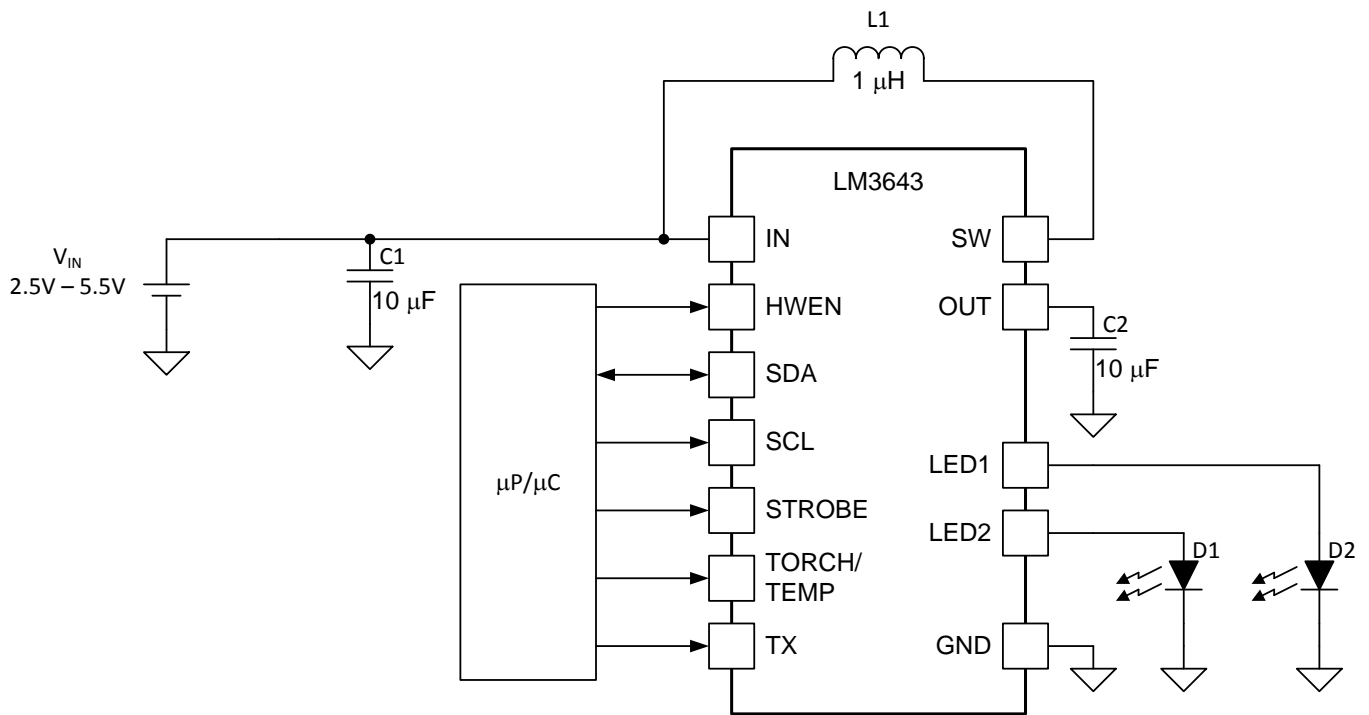

Figure 36. LM3643 Typical Application

#### 10.2.1 Design Requirements

Example requirements based on default register values:

DESIGN PARAMETER	EXAMPLE VALUE
Input Voltage Range	2.5 V to 5.5 V
Brightness Control	I <sup>2</sup> C Register
LED Configuration	2 Parallel Flash LEDs
Boost Switching Frequency	2 MHz (4 MHz selectable)
Flash Brightness	750 mA per LED

## 10.2.2 Detailed Design Procedure

### 10.2.2.1 Output Capacitor Selection

The LM3643 is designed to operate with a 10- $\mu$ F ceramic output capacitor. When the boost converter is running, the output capacitor supplies the load current during the boost converter on-time. When the NMOS switch turns off, the inductor energy is discharged through the internal PMOS switch, supplying power to the load and restoring charge to the output capacitor. This causes a sag in the output voltage during the on-time and a rise in the output voltage during the off-time. The output capacitor is therefore chosen to limit the output ripple to an acceptable level depending on load current and input/output voltage differentials and also to ensure the converter remains stable.

Larger capacitors such as a 22- $\mu$ F or capacitors in parallel can be used if lower output voltage ripple is desired. To estimate the output voltage ripple considering the ripple due to capacitor discharge ( $\Delta V_Q$ ) and the ripple due to the capacitors ESR ( $\Delta V_{ESR}$ ) use the following equations:

For continuous conduction mode, the output voltage ripple due to the capacitor discharge is:

$$\Delta V_Q = \frac{I_{LED} \times (V_{OUT} - V_{IN})}{f_{SW} \times V_{OUT} \times C_{OUT}} \quad (1)$$

The output voltage ripple due to the output capacitors ESR is found by:

$$\Delta V_{ESR} = R_{ESR} \times \left( \frac{I_{LED} \times V_{OUT}}{V_{IN}} + \Delta I_L \right)$$

where

$$\Delta I_L = \frac{V_{IN} \times (V_{OUT} - V_{IN})}{2 \times f_{SW} \times L \times V_{OUT}} \quad (2)$$

In ceramic capacitors the ESR is very low so the assumption is that 80% of the output voltage ripple is due to capacitor discharge and 20% from ESR. [Table 1](#) lists different manufacturers for various output capacitors and their case sizes suitable for use with the LM3643.

### 10.2.2.2 Input Capacitor Selection

Choosing the correct size and type of input capacitor helps minimize the voltage ripple caused by the switching of the LM3643 boost converter and reduce noise on the boost converter's input pin that can feed through and disrupt internal analog signals. In the typical application circuit a 10- $\mu$ F ceramic input capacitor works well. It is important to place the input capacitor as close as possible to the LM3643 input (IN) pin. This reduces the series resistance and inductance that can inject noise into the device due to the input switching currents. [Table 1](#) lists various input capacitors recommended for use with the LM3643.

**Table 1. Recommended Input/Output Capacitors (X5R/X7R Dielectric)**

MANUFACTURER	PART NUMBER	VALUE	CASE SIZE	VOLTAGE RATING
TDK Corporation	C1608JB0J106M	10 $\mu$ F	0603 (1.6 mm $\times$ 0.8 mm $\times$ 0.8 mm)	6.3 V
TDK Corporation	C2012JB1A106M	10 $\mu$ F	0805 (2.0 mm $\times$ 1.25 mm $\times$ 1.25 mm)	10 V
Murata	GRM188R60J106M	10 $\mu$ F	0603 (1.6 mm $\times$ 0.8 mm $\times$ 0.8 mm)	6.3 V
Murata	GRM21BR61A106KE19	10 $\mu$ F	0805 (2.0 mm $\times$ 1.25 mm $\times$ 1.25 mm)	10 V

### 10.2.2.3 Inductor Selection

The LM3643 is designed to use a 0.47- $\mu$ H or 1- $\mu$ H inductor. [Table 2](#) lists various inductors and their manufacturers that work well with the LM3643. When the device is boosting ( $V_{OUT} > V_{IN}$ ) the inductor is typically the largest area of efficiency loss in the circuit. Therefore, choosing an inductor with the lowest possible series resistance is important. Additionally, the saturation rating of the inductor should be greater than the maximum operating peak current of the LM3643. This prevents excess efficiency loss that can occur with inductors that operate in saturation. For proper inductor operation and circuit performance, ensure that the inductor saturation and the peak current limit setting of the LM3643 are greater than  $I_{PEAK}$  in the following calculation:



$$I_{PEAK} = \frac{I_{LOAD}}{\eta} \times \frac{V_{OUT}}{V_{IN}} + \Delta I_L \quad \text{where} \quad \Delta I_L = \frac{V_{IN} \times (V_{OUT} - V_{IN})}{2 \times f_{SW} \times L \times V_{OUT}}$$

where

- $f_{SW} = 2$  or  $4$  MHz

(3)

Efficiency details can be found in the [Application Curves](#).

**Table 2. Recommended Inductors**

MANUFACTURER	L	PART NUMBER	DIMENSIONS (LxWxH)	I <sub>SAT</sub>	R <sub>DC</sub>
TOKO	0.47 μH	DFE201610P-R470M	2.0 mm x 1.6 mm x 1.0 mm	4.1 A	32 mΩ
TOKO	1 μH	DFE201610P-1R0M	2.0 mm x 1.6 mm x 1.0 mm	3.7 A	58 mΩ

### 10.2.3 Application Curves

Ambient temperature is 25°C, input voltage is 3.6V, HWEN = V<sub>IN</sub>, C<sub>IN</sub> = 2 × 10 μF, C<sub>OUT</sub> = 2 × 10 μF and L = 1 μH, unless otherwise noted.

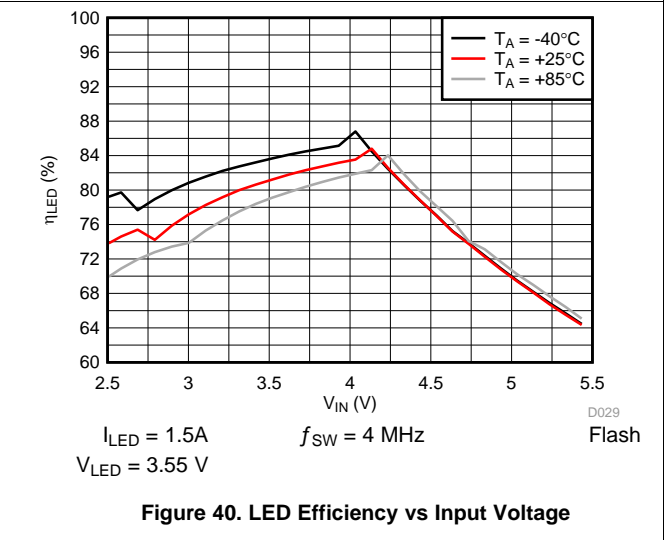
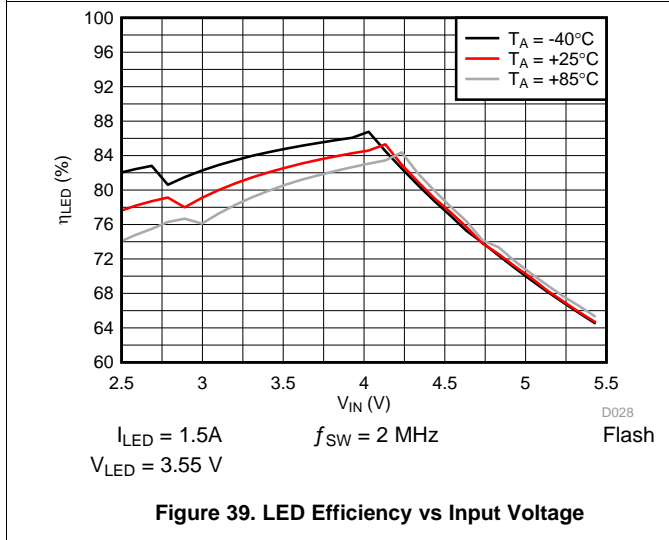
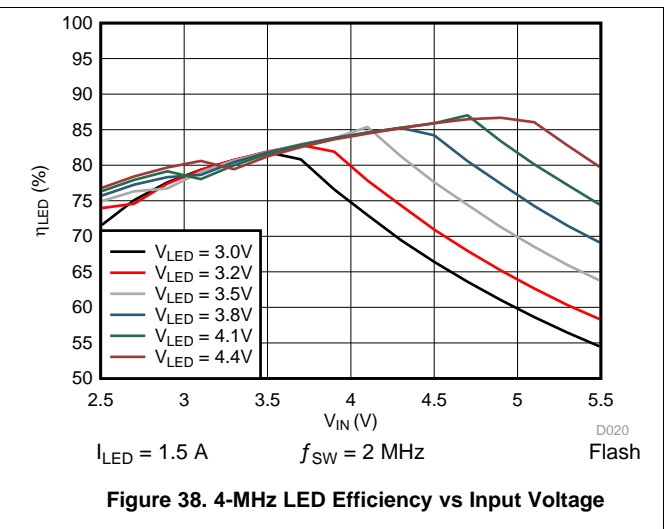
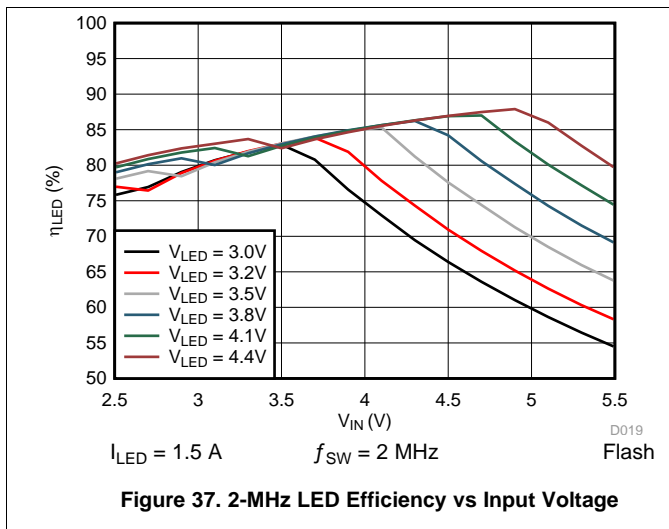

Ambient temperature is 25°C, input voltage is 3.6V, HWEN = V<sub>IN</sub>, C<sub>IN</sub> = 2 × 10 μF, C<sub>OUT</sub> = 2 × 10 μF and L = 1 μH, unless otherwise noted.

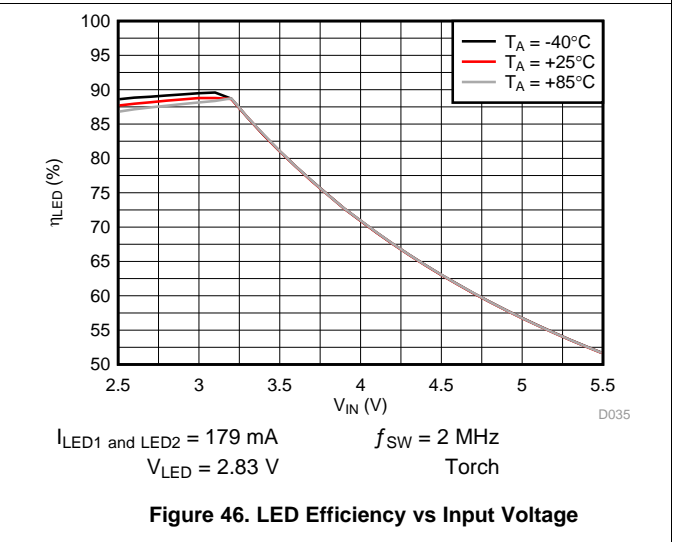
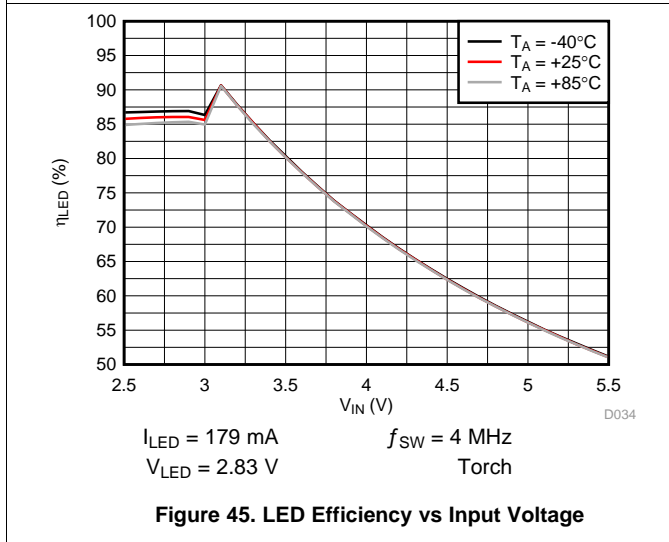
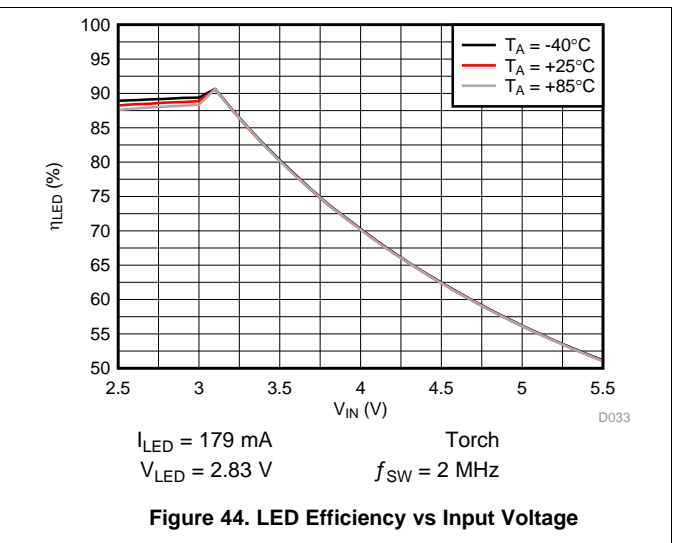
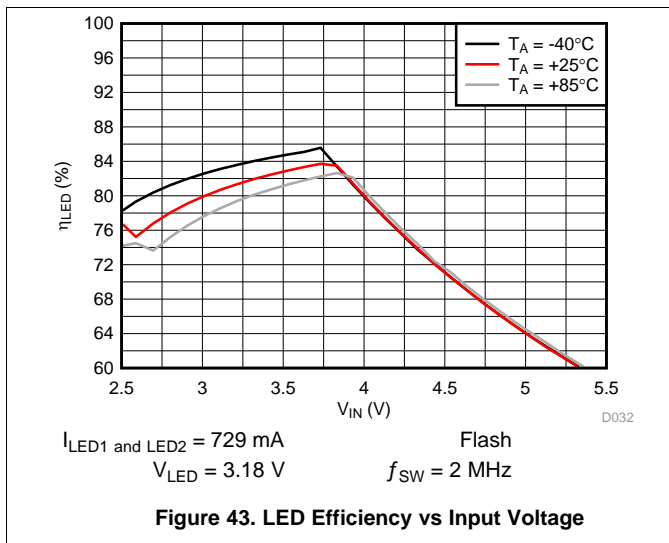
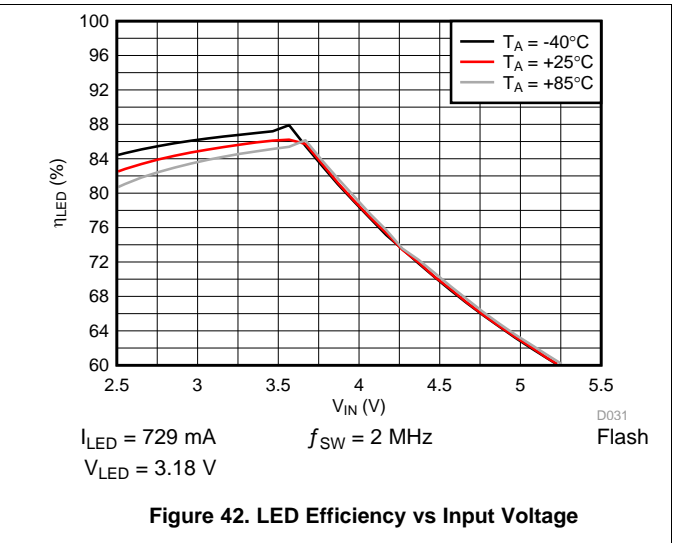
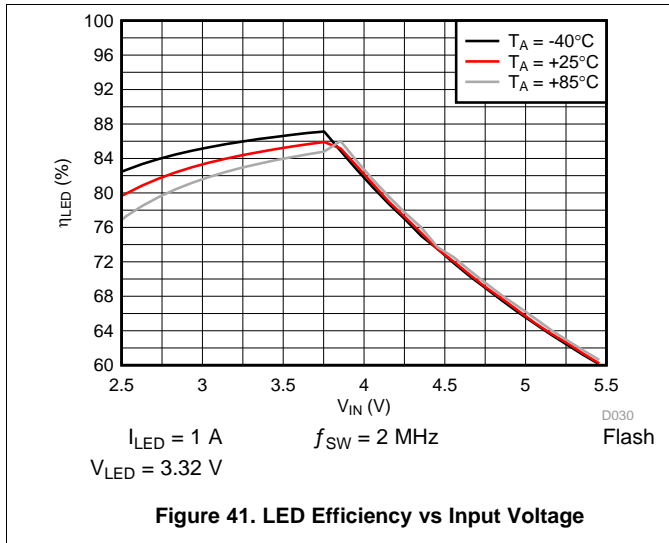

Ambient temperature is 25°C, input voltage is 3.6V, HWEN = V<sub>IN</sub>, C<sub>IN</sub> = 2 × 10 μF, C<sub>OUT</sub> = 2 × 10 μF and L = 1 μH, unless otherwise noted.

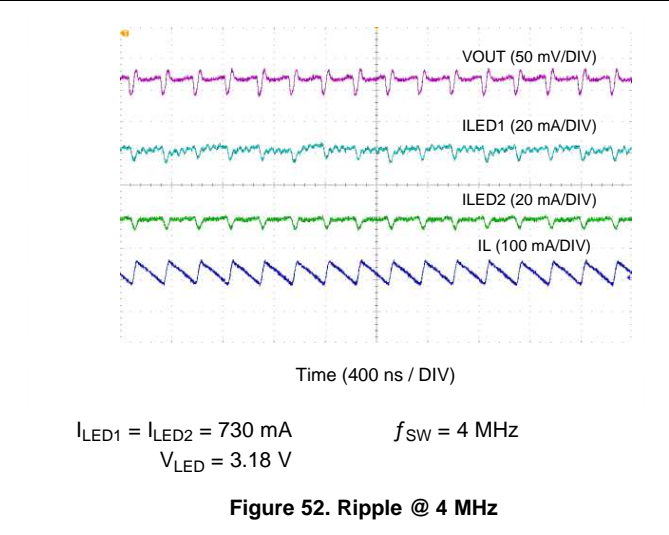
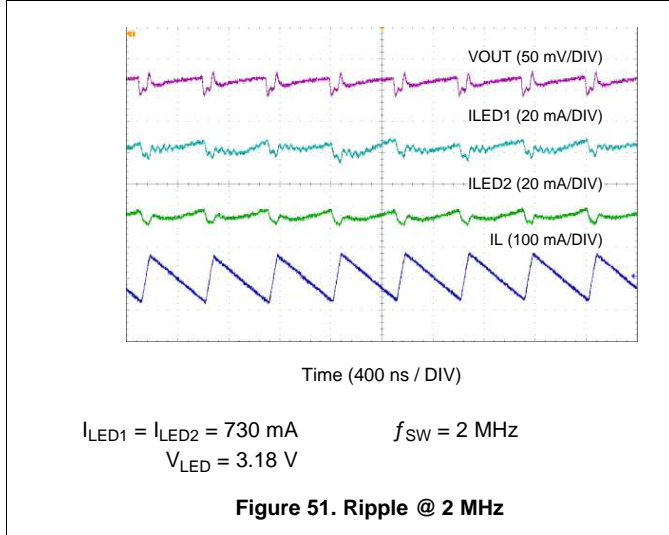
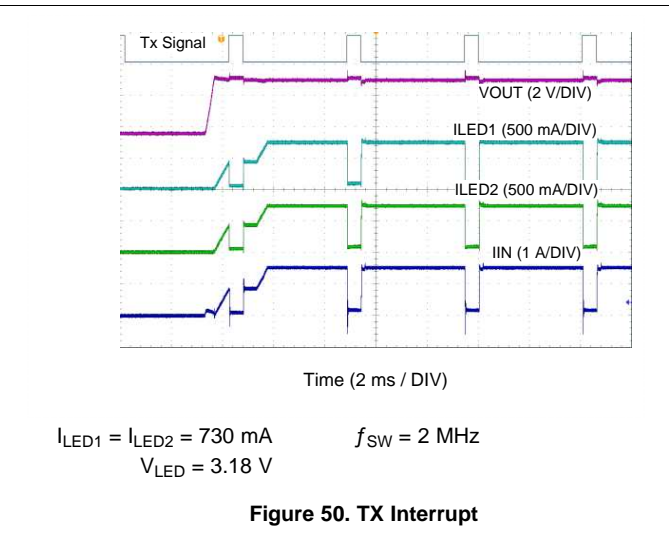
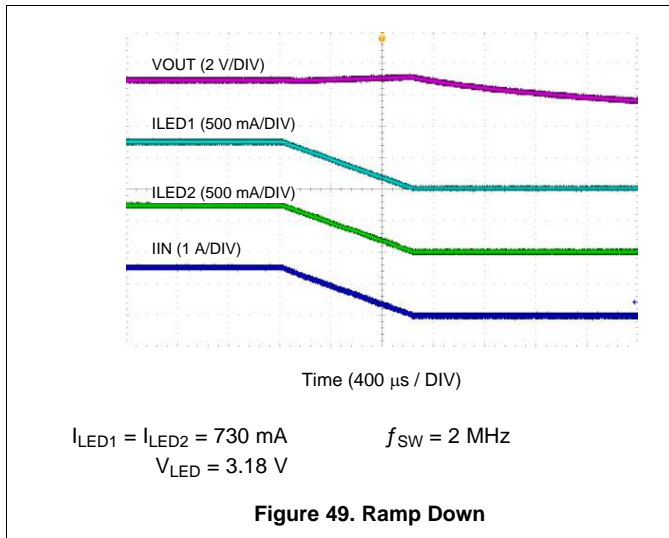
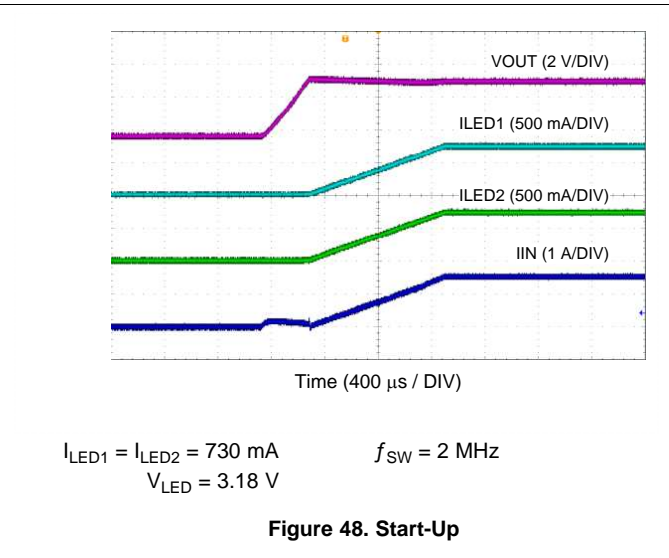
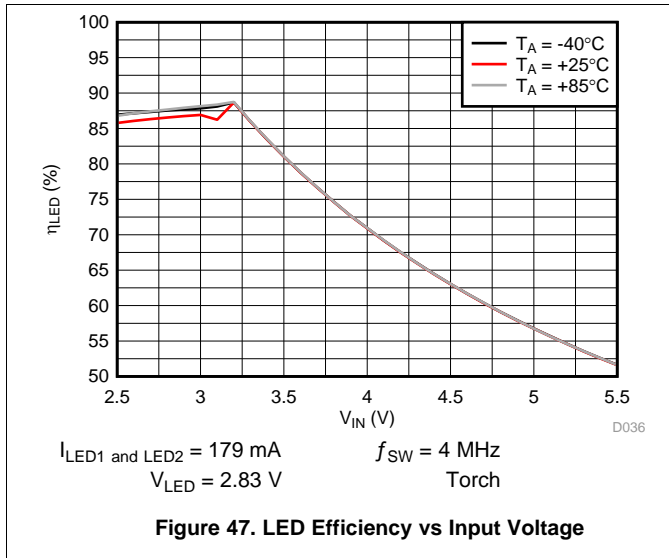

**LM3643, LM3643A**

SNVS967A – AUGUST 2014 – REVISED NOVEMBER 2014

[www.ti.com](http://www.ti.com)

Ambient temperature is 25°C, input voltage is 3.6V, HWEN = V<sub>IN</sub>, C<sub>IN</sub> = 2 × 10 μF, C<sub>OUT</sub> = 2 × 10 μF and L = 1 μH, unless otherwise noted.

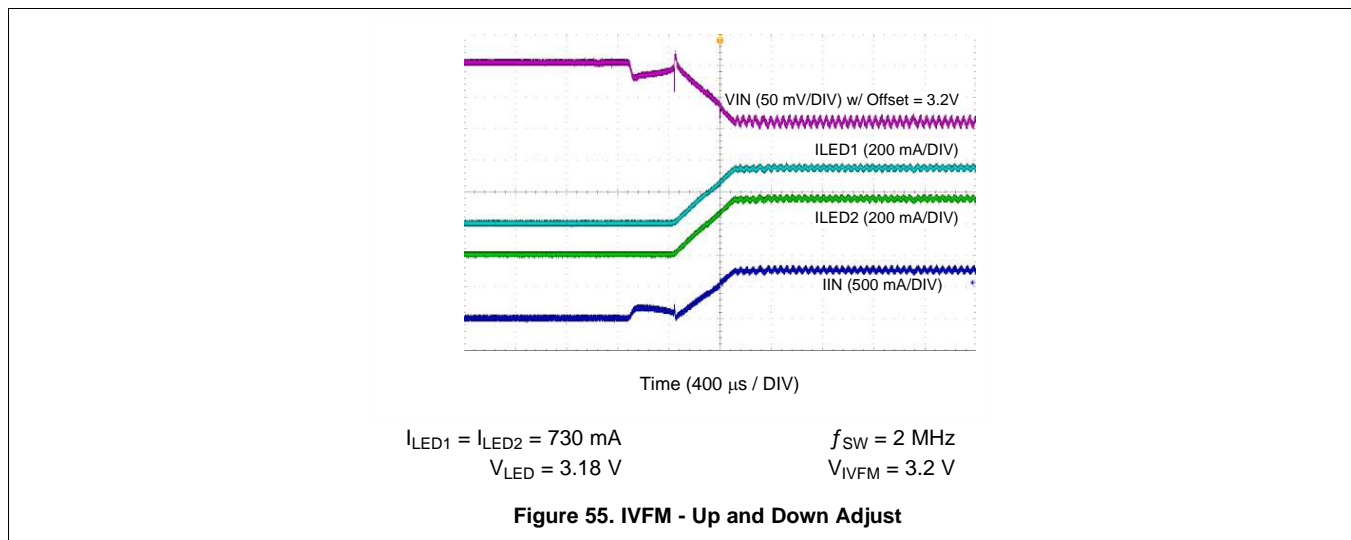
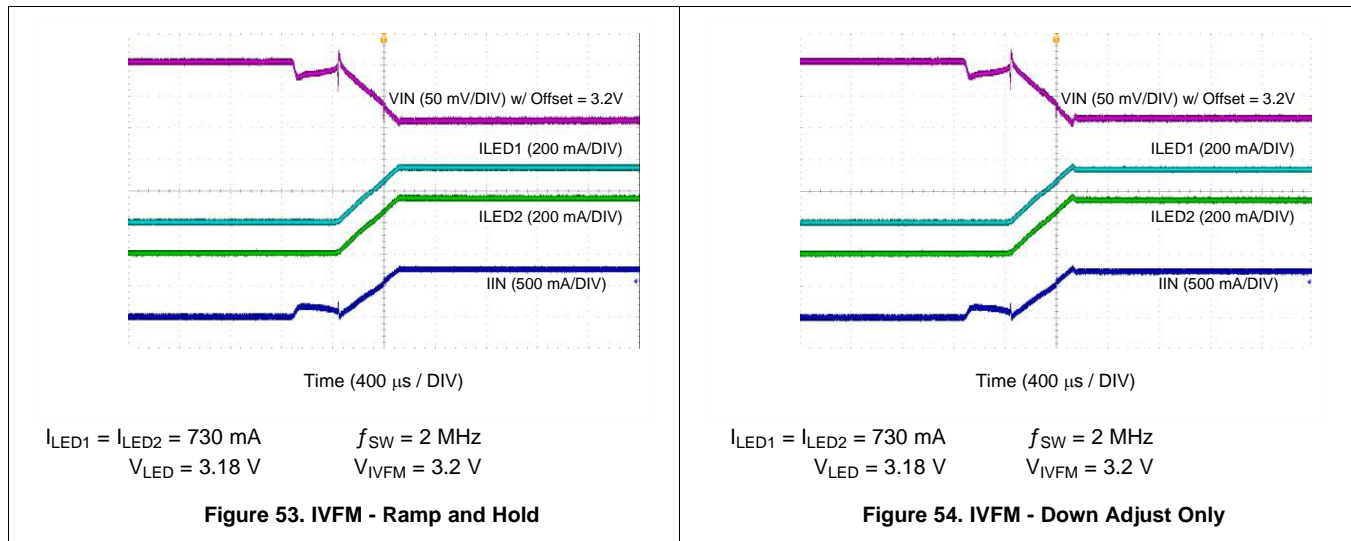

## 11 Power Supply Recommendations

The LM3643 is designed to operate from an input voltage supply range between 2.5 V and 5.5 V. This input supply must be well regulated and capable to supply the required input current. If the input supply is located far from the LM3643 additional bulk capacitance may be required in addition to the ceramic bypass capacitors.

## 12 Layout

### 12.1 Layout Guidelines

The high switching frequency and large switching currents of the LM3643 make the choice of layout important. The following steps should be used as a reference to ensure the device is stable and maintains proper LED current regulation across its intended operating voltage and current range.

1. Place  $C_{IN}$  on the top layer (same layer as the LM3643) and as close to the device as possible. The input capacitor conducts the driver currents during the low-side MOSFET turn-on and turn-off and can detect current spikes over 1 A in amplitude. Connecting the input capacitor through short, wide traces to both the IN and GND pins reduces the inductive voltage spikes that occur during switching which can corrupt the  $V_{IN}$  line.
2. Place  $C_{OUT}$  on the top layer (same layer as the LM3643) and as close as possible to the OUT and GND pin. The returns for both  $C_{IN}$  and  $C_{OUT}$  should come together at one point, as close to the GND pin as possible. Connecting  $C_{OUT}$  through short, wide traces reduce the series inductance on the OUT and GND pins that can corrupt the  $V_{OUT}$  and GND lines and cause excessive noise in the device and surrounding circuitry.
3. Connect the inductor on the top layer close to the SW pin. There should be a low-impedance connection from the inductor to SW due to the large DC inductor current, and at the same time the area occupied by the SW node should be small so as to reduce the capacitive coupling of the high  $dV/dT$  present at SW that can couple into nearby traces.
4. Avoid routing logic traces near the SW node so as to avoid any capacitively coupled voltages from SW onto any high-impedance logic lines such as TORCH/TEMP, STROBE, HWEN, SDA, and SCL. A good approach is to insert an inner layer GND plane underneath the SW node and between any nearby routed traces. This creates a shield from the electric field generated at SW.
5. Terminate the Flash LED cathodes directly to the GND pin of the LM3643. If possible, route the LED returns with a dedicated path so as to keep the high amplitude LED currents out of the GND plane. For Flash LEDs that are routed relatively far away from the LM3643, a good approach is to sandwich the forward and return current paths over the top of each other on two layers. This helps reduce the inductance of the LED current paths.

## 12.2 Layout Example

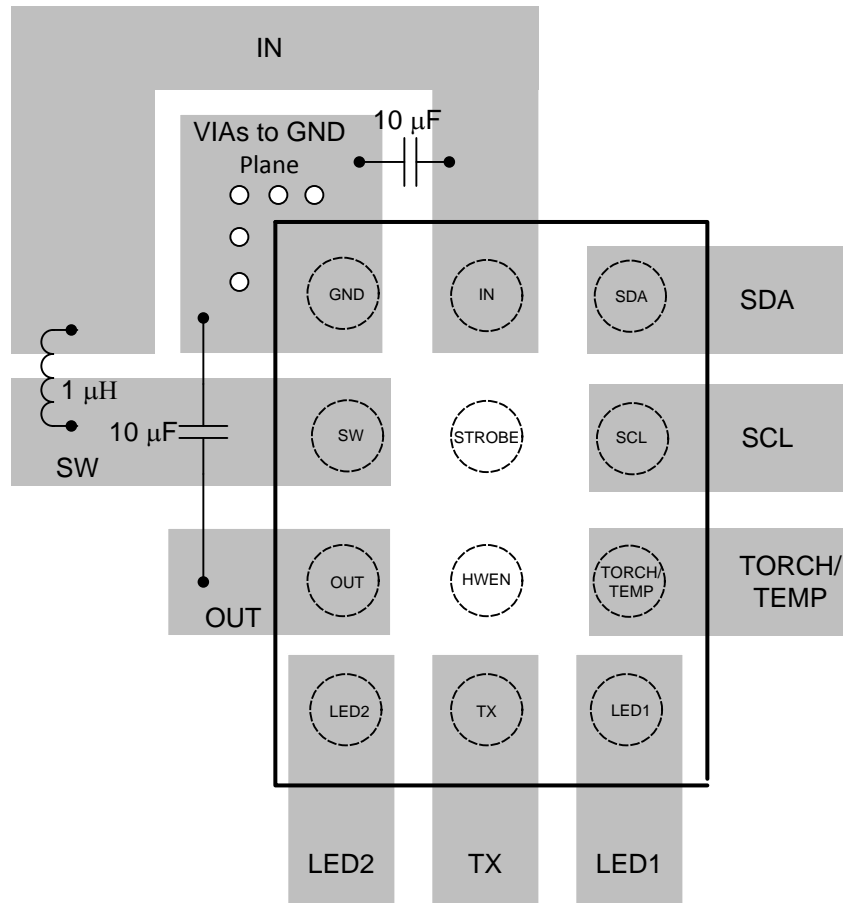

**Figure 56. Layout Example**

## 13 Device and Documentation Support

### 13.1 Device Support

#### 13.1.1 Third-Party Products Disclaimer

TI'S PUBLICATION OF INFORMATION REGARDING THIRD-PARTY PRODUCTS OR SERVICES DOES NOT CONSTITUTE AN ENDORSEMENT REGARDING THE SUITABILITY OF SUCH PRODUCTS OR SERVICES OR A WARRANTY, REPRESENTATION OR ENDORSEMENT OF SUCH PRODUCTS OR SERVICES, EITHER ALONE OR IN COMBINATION WITH ANY TI PRODUCT OR SERVICE.

### 13.2 Related Documentation

#### 13.2.1 Related Links

[Table 3](#) below lists quick access links. Categories include technical documents, support and community resources, tools and software, and quick access to sample or buy.

**Table 3. Related Links**

PARTS	PRODUCT FOLDER	SAMPLE & BUY	TECHNICAL DOCUMENTS	TOOLS & SOFTWARE	SUPPORT & COMMUNITY
LM3643	<a href="#">Click here</a>	<a href="#">Click here</a>	<a href="#">Click here</a>	<a href="#">Click here</a>	<a href="#">Click here</a>
LM3643A	<a href="#">Click here</a>	<a href="#">Click here</a>	<a href="#">Click here</a>	<a href="#">Click here</a>	<a href="#">Click here</a>

### 13.3 Trademarks

#### 13.4 Electrostatic Discharge Caution



This integrated circuit can be damaged by ESD. Texas Instruments recommends that all integrated circuits be handled with appropriate precautions. Failure to observe proper handling and installation procedures can cause damage.

ESD damage can range from subtle performance degradation to complete device failure. Precision integrated circuits may be more susceptible to damage because very small parametric changes could cause the device not to meet its published specifications.

#### 13.5 Glossary

[SLYZ022](#) — *TI Glossary*.

This glossary lists and explains terms, acronyms, and definitions.

## 14 Mechanical, Packaging, and Orderable Information

The following pages include mechanical, packaging, and orderable information. This information is the most current data available for the designated devices. This data is subject to change without notice and revision of this document. For browser-based versions of this data sheet, refer to the left-hand navigation.

**PACKAGING INFORMATION**

Orderable Device	Status (1)	Package Type	Package Drawing	Pins	Package Qty	Eco Plan (2)	Lead/Ball Finish (6)	MSL Peak Temp (3)	Op Temp (°C)	Device Marking (4/5)	Samples
LM3643AYFFR	ACTIVE	DSBGA	YFF	12	3000	Green (RoHS & no Sb/Br)	SNAGCU	Level-1-260C-UNLIM	-40 to 85	ZAAI	<a href="#">Samples</a>
LM3643YFFR	ACTIVE	DSBGA	YFF	12	3000	Green (RoHS & no Sb/Br)	SNAGCU	Level-1-260C-UNLIM	-40 to 85	3643	<a href="#">Samples</a>

(1) The marketing status values are defined as follows:

**ACTIVE:** Product device recommended for new designs.

**LIFEBUY:** TI has announced that the device will be discontinued, and a lifetime-buy period is in effect.

**NRND:** Not recommended for new designs. Device is in production to support existing customers, but TI does not recommend using this part in a new design.

**PREVIEW:** Device has been announced but is not in production. Samples may or may not be available.

**OBSELETE:** TI has discontinued the production of the device.

(2) Eco Plan - The planned eco-friendly classification: Pb-Free (RoHS), Pb-Free (RoHS Exempt), or Green (RoHS & no Sb/Br) - please check <http://www.ti.com/productcontent> for the latest availability information and additional product content details.

**TBD:** The Pb-Free/Green conversion plan has not been defined.

**Pb-Free (RoHS):** TI's terms "Lead-Free" or "Pb-Free" mean semiconductor products that are compatible with the current RoHS requirements for all 6 substances, including the requirement that lead not exceed 0.1% by weight in homogeneous materials. Where designed to be soldered at high temperatures, TI Pb-Free products are suitable for use in specified lead-free processes.

**Pb-Free (RoHS Exempt):** This component has a RoHS exemption for either 1) lead-based flip-chip solder bumps used between the die and package, or 2) lead-based die adhesive used between the die and leadframe. The component is otherwise considered Pb-Free (RoHS compatible) as defined above.

**Green (RoHS & no Sb/Br):** TI defines "Green" to mean Pb-Free (RoHS compatible), and free of Bromine (Br) and Antimony (Sb) based flame retardants (Br or Sb do not exceed 0.1% by weight in homogeneous material)

(3) MSL, Peak Temp. - The Moisture Sensitivity Level rating according to the JEDEC industry standard classifications, and peak solder temperature.

(4) There may be additional marking, which relates to the logo, the lot trace code information, or the environmental category on the device.

(5) Multiple Device Markings will be inside parentheses. Only one Device Marking contained in parentheses and separated by a "~" will appear on a device. If a line is indented then it is a continuation of the previous line and the two combined represent the entire Device Marking for that device.

(6) Lead/Ball Finish - Orderable Devices may have multiple material finish options. Finish options are separated by a vertical ruled line. Lead/Ball Finish values may wrap to two lines if the finish value exceeds the maximum column width.

**Important Information and Disclaimer:** The information provided on this page represents TI's knowledge and belief as of the date that it is provided. TI bases its knowledge and belief on information provided by third parties, and makes no representation or warranty as to the accuracy of such information. Efforts are underway to better integrate information from third parties. TI has taken and continues to take reasonable steps to provide representative and accurate information but may not have conducted destructive testing or chemical analysis on incoming materials and chemicals. TI and TI suppliers consider certain information to be proprietary, and thus CAS numbers and other limited information may not be available for release.



In no event shall TI's liability arising out of such information exceed the total purchase price of the TI part(s) at issue in this document sold by TI to Customer on an annual basis.

**TAPE AND REEL INFORMATION**

**QUADRANT ASSIGNMENTS FOR PIN 1 ORIENTATION IN TAPE**

\*All dimensions are nominal

Device	Package Type	Package Drawing	Pins	SPQ	Reel Diameter (mm)	Reel Width W1 (mm)	A0 (mm)	B0 (mm)	K0 (mm)	P1 (mm)	W (mm)	Pin1 Quadrant
LM3643AYFFR	DSBGA	YFF	12	3000	180.0	8.4	1.38	1.76	0.77	4.0	8.0	Q1
LM3643YFFR	DSBGA	YFF	12	3000	180.0	8.4	1.38	1.76	0.77	4.0	8.0	Q1

TAPE AND REEL BOX DIMENSIONS



\*All dimensions are nominal

Device	Package Type	Package Drawing	Pins	SPQ	Length (mm)	Width (mm)	Height (mm)
LM3643AYFFR	DSBGA	YFF	12	3000	182.0	182.0	20.0
LM3643YFFR	DSBGA	YFF	12	3000	182.0	182.0	20.0

YFF0012

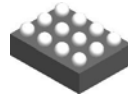

PACKAGE OUTLINE

DSBGA - 0.625 mm max height

DIE SIZE BALL GRID ARRAY

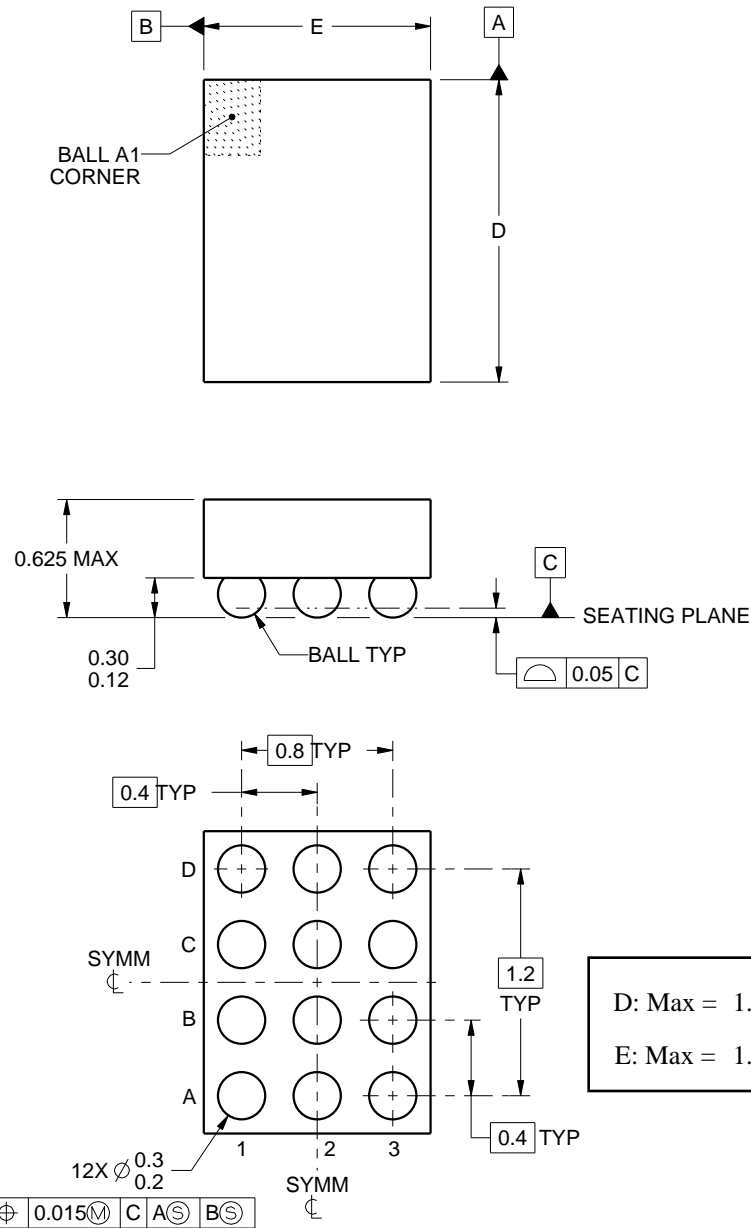

4222191/A 07/2015

NOTES:

1. All linear dimensions are in millimeters. Any dimensions in parenthesis are for reference only. Dimensioning and tolerancing per ASME Y14.5M.
2. This drawing is subject to change without notice.

# EXAMPLE BOARD LAYOUT

YFF0012

DSBGA - 0.625 mm max height

DIE SIZE BALL GRID ARRAY

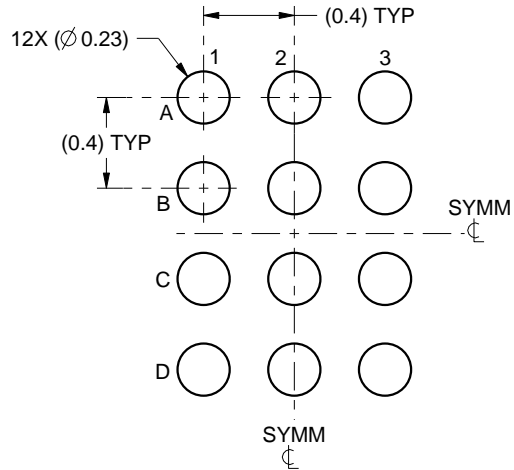

LAND PATTERN EXAMPLE  
SCALE:30X

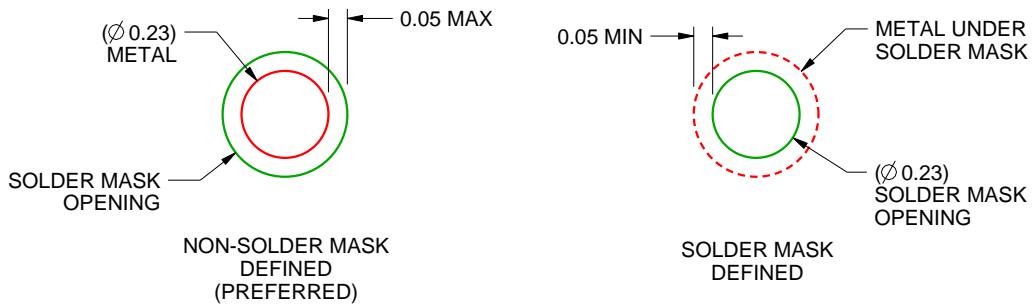

SOLDER MASK DETAILS  
NOT TO SCALE

4222191/A 07/2015

NOTES: (continued)

3. Final dimensions may vary due to manufacturing tolerance considerations and also routing constraints. For more information, see Texas Instruments literature number SNVA009 ([www.ti.com/lit/snva009](http://www.ti.com/lit/snva009)).

# EXAMPLE STENCIL DESIGN

YFF0012

DSBGA - 0.625 mm max height

DIE SIZE BALL GRID ARRAY

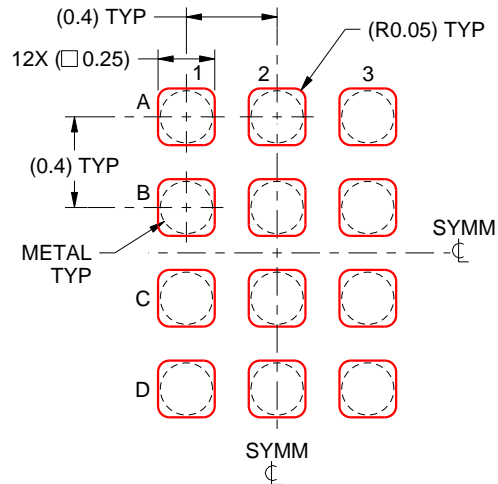

SOLDER PASTE EXAMPLE  
BASED ON 0.1 mm THICK STENCIL  
SCALE:30X

4222191/A 07/2015

NOTES: (continued)

4. Laser cutting apertures with trapezoidal walls and rounded corners may offer better paste release.

## IMPORTANT NOTICE

Texas Instruments Incorporated (TI) reserves the right to make corrections, enhancements, improvements and other changes to its semiconductor products and services per JESD46, latest issue, and to discontinue any product or service per JESD48, latest issue. Buyers should obtain the latest relevant information before placing orders and should verify that such information is current and complete.

TI's published terms of sale for semiconductor products (<http://www.ti.com/sc/docs/stdterms.htm>) apply to the sale of packaged integrated circuit products that TI has qualified and released to market. Additional terms may apply to the use or sale of other types of TI products and services.

Reproduction of significant portions of TI information in TI data sheets is permissible only if reproduction is without alteration and is accompanied by all associated warranties, conditions, limitations, and notices. TI is not responsible or liable for such reproduced documentation. Information of third parties may be subject to additional restrictions. Resale of TI products or services with statements different from or beyond the parameters stated by TI for that product or service voids all express and any implied warranties for the associated TI product or service and is an unfair and deceptive business practice. TI is not responsible or liable for any such statements.

Buyers and others who are developing systems that incorporate TI products (collectively, "Designers") understand and agree that Designers remain responsible for using their independent analysis, evaluation and judgment in designing their applications and that Designers have full and exclusive responsibility to assure the safety of Designers' applications and compliance of their applications (and of all TI products used in or for Designers' applications) with all applicable regulations, laws and other applicable requirements. Designer represents that, with respect to their applications, Designer has all the necessary expertise to create and implement safeguards that (1) anticipate dangerous consequences of failures, (2) monitor failures and their consequences, and (3) lessen the likelihood of failures that might cause harm and take appropriate actions. Designer agrees that prior to using or distributing any applications that include TI products, Designer will thoroughly test such applications and the functionality of such TI products as used in such applications.

TI's provision of technical, application or other design advice, quality characterization, reliability data or other services or information, including, but not limited to, reference designs and materials relating to evaluation modules, (collectively, "TI Resources") are intended to assist designers who are developing applications that incorporate TI products; by downloading, accessing or using TI Resources in any way, Designer (individually or, if Designer is acting on behalf of a company, Designer's company) agrees to use any particular TI Resource solely for this purpose and subject to the terms of this Notice.

TI's provision of TI Resources does not expand or otherwise alter TI's applicable published warranties or warranty disclaimers for TI products, and no additional obligations or liabilities arise from TI providing such TI Resources. TI reserves the right to make corrections, enhancements, improvements and other changes to its TI Resources. TI has not conducted any testing other than that specifically described in the published documentation for a particular TI Resource.

Designer is authorized to use, copy and modify any individual TI Resource only in connection with the development of applications that include the TI product(s) identified in such TI Resource. NO OTHER LICENSE, EXPRESS OR IMPLIED, BY ESTOPPEL OR OTHERWISE TO ANY OTHER TI INTELLECTUAL PROPERTY RIGHT, AND NO LICENSE TO ANY TECHNOLOGY OR INTELLECTUAL PROPERTY RIGHT OF TI OR ANY THIRD PARTY IS GRANTED HEREIN, including but not limited to any patent right, copyright, mask work right, or other intellectual property right relating to any combination, machine, or process in which TI products or services are used. Information regarding or referencing third-party products or services does not constitute a license to use such products or services, or a warranty or endorsement thereof. Use of TI Resources may require a license from a third party under the patents or other intellectual property of the third party, or a license from TI under the patents or other intellectual property of TI.

TI RESOURCES ARE PROVIDED "AS IS" AND WITH ALL FAULTS. TI DISCLAIMS ALL OTHER WARRANTIES OR REPRESENTATIONS, EXPRESS OR IMPLIED, REGARDING RESOURCES OR USE THEREOF, INCLUDING BUT NOT LIMITED TO ACCURACY OR COMPLETENESS, TITLE, ANY EPIDEMIC FAILURE WARRANTY AND ANY IMPLIED WARRANTIES OF MERCHANTABILITY, FITNESS FOR A PARTICULAR PURPOSE, AND NON-INFRINGEMENT OF ANY THIRD PARTY INTELLECTUAL PROPERTY RIGHTS. TI SHALL NOT BE LIABLE FOR AND SHALL NOT DEFEND OR INDEMNIFY DESIGNER AGAINST ANY CLAIM, INCLUDING BUT NOT LIMITED TO ANY INFRINGEMENT CLAIM THAT RELATES TO OR IS BASED ON ANY COMBINATION OF PRODUCTS EVEN IF DESCRIBED IN TI RESOURCES OR OTHERWISE. IN NO EVENT SHALL TI BE LIABLE FOR ANY ACTUAL, DIRECT, SPECIAL, COLLATERAL, INDIRECT, PUNITIVE, INCIDENTAL, CONSEQUENTIAL OR EXEMPLARY DAMAGES IN CONNECTION WITH OR ARISING OUT OF TI RESOURCES OR USE THEREOF, AND REGARDLESS OF WHETHER TI HAS BEEN ADVISED OF THE POSSIBILITY OF SUCH DAMAGES.

Unless TI has explicitly designated an individual product as meeting the requirements of a particular industry standard (e.g., ISO/TS 16949 and ISO 26262), TI is not responsible for any failure to meet such industry standard requirements.

Where TI specifically promotes products as facilitating functional safety or as compliant with industry functional safety standards, such products are intended to help enable customers to design and create their own applications that meet applicable functional safety standards and requirements. Using products in an application does not by itself establish any safety features in the application. Designers must ensure compliance with safety-related requirements and standards applicable to their applications. Designer may not use any TI products in life-critical medical equipment unless authorized officers of the parties have executed a special contract specifically governing such use. Life-critical medical equipment is medical equipment where failure of such equipment would cause serious bodily injury or death (e.g., life support, pacemakers, defibrillators, heart pumps, neurostimulators, and implantables). Such equipment includes, without limitation, all medical devices identified by the U.S. Food and Drug Administration as Class III devices and equivalent classifications outside the U.S.

TI may expressly designate certain products as completing a particular qualification (e.g., Q100, Military Grade, or Enhanced Product). Designers agree that it has the necessary expertise to select the product with the appropriate qualification designation for their applications and that proper product selection is at Designers' own risk. Designers are solely responsible for compliance with all legal and regulatory requirements in connection with such selection.

Designer will fully indemnify TI and its representatives against any damages, costs, losses, and/or liabilities arising out of Designer's non-compliance with the terms and provisions of this Notice.