

LM6181 100 mA, 100 MHz Current Feedback Amplifier

1 Features⁽¹⁾

- Slew Rate: 2000 V/ μ s
- Settling Time (0.1%): 50 ns
- Characterized for Supply Ranges: ± 5 V and ± 15 V
- Low Differential Gain and Phase Error: 0.05%, 0.04°
- High Output Drive: ± 10 V into 100 Ω
- Ensured Bandwidth and Slew Rate
- Improved Performance Over EL2020, OP160, AD844, LT1223 and HA5004

(1) Typical, unless otherwise noted

2 Applications

- Coax Cable Driver
- Video Amplifier
- Flash ADC Buffer
- High Frequency Filter
- Scanner and Imaging Systems

3 Description

The LM6181 current-feedback amplifier offers an unparalleled combination of bandwidth, slew-rate, and output current. The amplifier can directly drive up to 100 pF capacitive loads without oscillating and a 10-V signal into a 50- Ω or 75- Ω back-terminated coax cable system over the full industrial temperature range. This represents a radical enhancement in output drive capability for an 8-pin PDIP high-speed amplifier making it ideal for video applications.

Built on TI's advanced high-speed VIP™ II (Vertically Integrated PNP) process, the LM6181 employs current-feedback providing bandwidth that does not vary dramatically with gain; 100 MHz at $A_V = -1$, 60 MHz at $A_V = -10$. With a slew rate of 2000V/ μ s, 2nd harmonic distortion of -50 dBc at 10 MHz and settling time of 50 ns (0.1%) the LM6181 dynamic performance makes it ideal for data acquisition, high speed ATE, and precision pulse amplifier applications.

Device Information⁽¹⁾

PART NUMBER	PACKAGE	BODY SIZE (NOM)
LM6181	PDIP (8)	9.81 mm x 6.35 mm
LM6181	CDIP (8)	10.16 mm x 6.502 mm
LM6181	SOIC (16)	9.90 mm x 3.91 mm

(1) For all available packages, see the orderable addendum at the end of the datasheet.

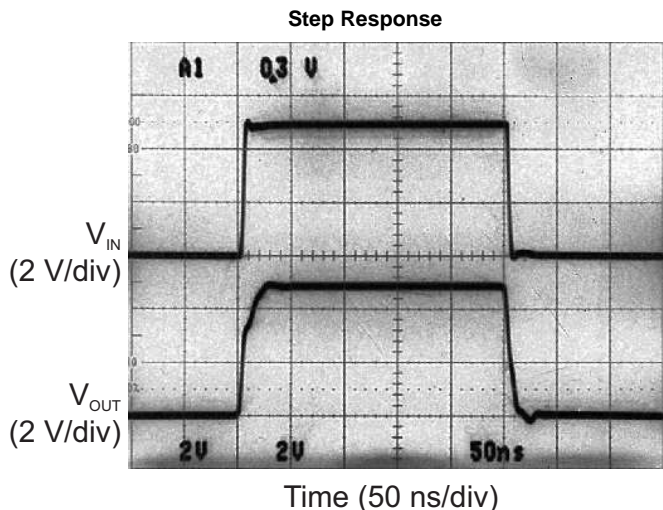
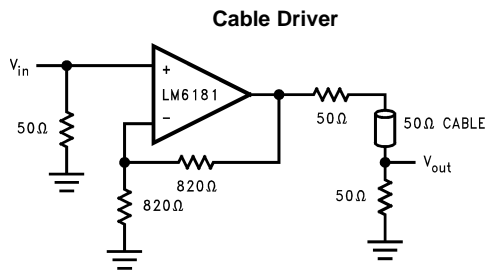

Table of Contents

1 Features 1 2 Applications 1 3 Description 1 4 Revision History 2 5 Pin Configuration and Functions 3 6 Specifications 4 6.1 Absolute Maximum Ratings 4 6.2 Handling Ratings 4 6.3 Recommended Operating Conditions 4 6.4 Thermal Information 4 6.5 ±15V DC Electrical Characteristics 5 6.6 ±15V AC Electrical Characteristics 6 6.7 ±5V DC Electrical Characteristics 7 6.8 ±5V AC Electrical Characteristics 8 6.9 Typical Performance Characteristics 9	7 Typical Applications 22 7.1 Current Feedback Topology 22 7.2 Power Supply Bypassing and Layout Considerations 23 7.3 Feedback Resistor Selection: R _f 23 7.4 Slew Rate Considerations 24 7.5 Driving Capacitive Loads 25 7.6 Capacitive Feedback 27 8 Application and Implementation 28 8.1 Typical Application 28 9 Device and Documentation Support 32 9.1 Trademarks 32 9.2 Electrostatic Discharge Caution 32 9.3 Glossary 32 10 Mechanical, Packaging, and Orderable Information 32
--	--

4 Revision History

NOTE: Page numbers for previous revisions may differ from page numbers in the current version.

Changes from Revision B (May 2013) to Revision C	Page
<ul style="list-style-type: none"> • Changed data sheet structure and organization. Added, updated, or renamed the following sections: Device Information Table, Pin Configuration and Functions, Application and Implementation; Device and Documentation Support; Mechanical, Packaging, and Ordering Information. Updated selected plots for readability. 1 • Changed "Junction Temperature Range" to "Operating Temperature Range" and deleted T_J 4 • Deleted T_J = 25°C for Electrical Characteristics tables 5 	

Changes from Revision A (May 2013) to Revision B	Page
<ul style="list-style-type: none"> • Changed layout of National Data Sheet to TI format 1 	

5 Pin Configuration and Functions

* indicates heat sinking pins⁽¹⁾

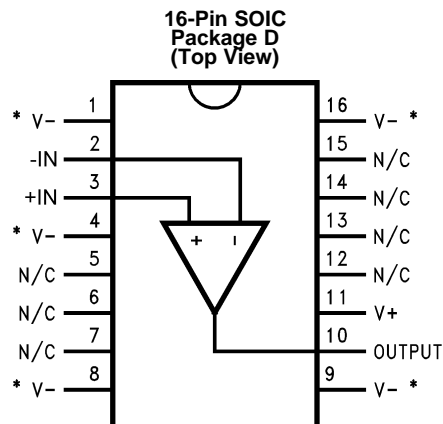
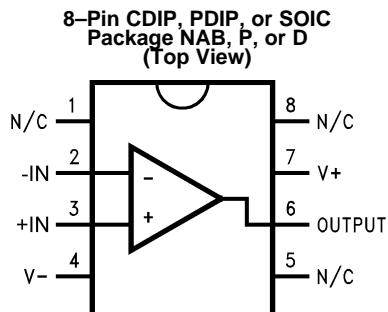

Pin Functions

NAME	PIN NUMBER		I/O	DESCRIPTION
	NAB, P, D (8)	D (16)		
-IN	2	2	I	Inverting Input
+IN	3	3	I	Non-inverting Input
N/C	1, 5, 8	5, 6, 7 12, 13, 14, 15	—	No Connection
OUTPUT	6	10	O	Output
V-	4	1, 4, 8, 9, 16	I	Negative Supply
V+	7	11	I	Positive Supply

- (1) The typical junction-to-ambient thermal resistance of the molded PDIP package soldered directly into a PC board is 102°C/W. The junction-to-ambient thermal resistance of the SOIC package mounted flush to the PC board is 70°C/W when pins 1, 4, 8, 9 and 16 are soldered to a total 2 in² 1 oz. copper trace. The 16-pin SOIC package must have pin 4 and at least one of pins 1, 8, 9, or 16 connected to V⁻ for proper operation. The typical junction-to-ambient thermal resistance of the SOIC package soldered directly into a PC board is 153°C/W.

6 Specifications

6.1 Absolute Maximum Ratings⁽¹⁾⁽²⁾

over operating free-air temperature range (unless otherwise noted)

		MIN	MAX	UNIT	
Supply Voltage			±18	V	
Differential Input Voltage			±6	V	
Input Voltage			±Supply Voltage	V	
Inverting Input Current			15	mA	
Soldering Information	PDIP Package	Soldering (10 sec)		260	°C
	SOIC Package	Vapor Phase (60 seconds)		215	°C
		Infrared (15 seconds)		220	°C
Output Short Circuit			See ⁽³⁾		
Maximum Junction Temperature			150	°C	

- (1) Absolute Maximum Ratings indicate limits beyond which damage to the device may occur. Operating ratings indicate conditions the device is intended to be functional, but device parameter specifications may not be ensured under these conditions. For ensured specifications and test conditions, see the Electrical Characteristics.
- (2) If Military/Aerospace specified devices are required, please contact the Texas Instruments Sales Office/ Distributors for availability and specifications.
- (3) Continuous short circuit operation at elevated ambient temperature can result in exceeding the maximum allowed junction temperature of 150°C. Output currents in excess of ±130 mA over a long term basis may adversely affect reliability.

6.2 Handling Ratings

		MIN	MAX	UNIT
T _{stg}	Storage temperature range	-65	+150	°C
V _(ESD)	Electrostatic discharge	Human body model (HBM), per ANSI/ESDA/JEDEC JS-001, all pins ⁽¹⁾		±3000 V

- (1) JEDEC document JEP155 states that 3000-V HBM allows safe manufacturing with a standard ESD control process. Human body model 100 pF and 1.5 kΩ.

6.3 Recommended Operating Conditions⁽¹⁾

over operating free-air temperature range (unless otherwise noted)

		MIN	MAX	UNIT
Supply Voltage Range		7	32	V
Operating Temperature Range	LM6181AM	-55	+125	°C
	LM6181AI, LM6181I	-40	+85	°C

- (1) For ensured Military Temperature Range parameters see RETS6181X.

6.4 Thermal Information

THERMAL METRIC ⁽¹⁾⁽²⁾		P (PDIP)	D (SOIC)	D (SOIC)	UNIT
		8 PINS	8 PINS	16 PINS	
R _{θJA}	Junction-to-ambient thermal resistance	102	153	70	°C/W
R _{θJC(top)}	Junction-to-case (top) thermal resistance	42	42	38	

- (1) For more information about traditional and new thermal metrics, see the *IC Package Thermal Metrics* application report, [SPRA953](#).
- (2) The typical junction-to-ambient thermal resistance of the molded PDIP package soldered directly into a PC board is 102°C/W. The junction-to-ambient thermal resistance of the SOIC package mounted flush to the PC board is 70°C/W when pins 1, 4, 8, 9 and 16 are soldered to a total 2 in2 1 oz. copper trace. The 16-pin SOIC package must have pin 4 and at least one of pins 1, 8, 9, or 16 connected to V– for proper operation. The typical junction-to-ambient thermal resistance of the SOIC package soldered directly into a PC board is 153°C/W."

6.5 ±15V DC Electrical Characteristics

The following specifications apply for Supply Voltage = ±15V, $R_F = 820 \Omega$, and $R_L = 1 \text{ k}\Omega$ unless otherwise noted. **Boldface** limits apply at the temperature extremes.

PARAMETER	TEST CONDITIONS	LM6181AM		LM6181AI		LM6181I		UNIT
		TYP ⁽¹⁾	LIMIT ⁽²⁾	TYP ⁽¹⁾	LIMIT ⁽²⁾	TYP ⁽¹⁾	LIMIT ⁽²⁾	
V_{OS}	Input Offset Voltage	2.0	3.0 4.0	2.0	3.0 3.5	3.5	5.0 5.5	mV max
TC V_{OS}	Input Offset Voltage Drift	5.0		5.0		5.0		$\mu\text{V}/^\circ\text{C}$
I_B	Inverting Input Bias Current	2.0	5.0 12.0	2.0	5.0 12.0	5.0	10 17.0	μA max
	Non-Inverting Input Bias Current	0.5	1.5 3.0	0.5	1.5 3.0	2.0	3.0 5.0	
TC I_B	Inverting Input Bias Current Drift	30		30		30		nA/ $^\circ\text{C}$
	Non-Inverting Input Bias Current Drift	10		10		10		
I_B PSR	Inverting Input Bias Current Power Supply Rejection	$V_S = \pm 4.5\text{V}, \pm 16\text{V}$		0.3	0.5 3.0	0.3	0.75 4.5	$\mu\text{A}/\text{V}$ max
	Non-Inverting Input Bias Current Power Supply Rejection	$V_S = \pm 4.5\text{V}, \pm 16\text{V}$		0.05	0.5 1.5	0.05	0.5 3.0	
I_B CMR	Inverting Input Bias Current Common Mode Rejection	$-10\text{V} \leq V_{CM} \leq +10\text{V}$		0.3	0.5 0.75	0.3	0.75 1.0	
	Non-Inverting Input Bias Current Common Mode Rejection	$-10\text{V} \leq V_{CM} \leq +10\text{V}$		0.1	0.5 0.5	0.1	0.5 0.5	
CMRR	Common Mode Rejection Ratio	$-10\text{V} \leq V_{CM} \leq +10\text{V}$		60	50 50	60	50 50	dB min
PSRR	Power Supply Rejection Ratio	$V_S = \pm 4.5\text{V}, \pm 16\text{V}$		80	70 70	80	70 65	dB min
R_O	Output Resistance	$A_V = -1, f = 300 \text{ kHz}$		0.2		0.2		Ω
R_{IN}	Non-Inverting Input Resistance			10		10		M Ω min
V_O	Output Voltage Swing	$R_L = 1 \text{ k}\Omega$		12	11 11	12	11 11	V min
		$R_L = 100\Omega$		11	10 7.5	11	10 8.0	
I_{SC}	Output Short Circuit Current			130	100 75	130	100 85	mA min
Z_T	Transimpedance	$R_L = 1 \text{ k}\Omega$		1.8	1.0 0.5	1.8	1.0 0.5	M Ω min
		$R_L = 100\Omega$		1.4	0.8 0.4	1.4	0.8 0.4	
I_S	Supply Current	No Load, $V_O = 0\text{V}$		7.5	10 10	7.5	10 10	mA max
V_{CM}	Input Common Mode Voltage Range			$V^+ - 1.7$ $V^- + 1.7$		$V^+ - 1.7$ $V^- + 1.7$		V

(1) Typical values represent the most likely parametric norm.

(2) All limits ensured at room temperature (standard type face) or at operating temperature extremes (**bold face type**).

6.6 ±15V AC Electrical Characteristics

The following specifications apply for Supply Voltage = ±15V, $R_F = 820 \Omega$, $R_L = 1 \text{ k}\Omega$ unless otherwise noted. **Boldface** limits apply at the temperature extremes.

PARAMETER	TEST CONDITIONS	LM6181AM		LM6181AI		LM6181I		UNIT				
		TYP ⁽¹⁾	LIMIT ⁽²⁾	TYP ⁽¹⁾	LIMIT ⁽²⁾	TYP ⁽¹⁾	LIMIT ⁽²⁾					
BW	Closed Loop Bandwidth –3 dB	$A_V = +2$		100		100		MHz min				
		$A_V = +10$		80		80						
		$A_V = -1$		100		80			100		80	
		$A_V = -10$		60		60			60			
PBW	Power Bandwidth	$A_V = -1, V_O = 5 V_{PP}$		60		60		60				
SR	Slew Rate	Overdriven		2000		2000		2000	V/ μ s min			
		$A_V = -1, V_O = \pm 10V, R_L = 150\Omega^{(3)}$		1400		1000		1400		1000		
t_s	Settling Time (0.1%)	$A_V = -1, V_O = \pm 5V, R_L = 150\Omega$		50		50		50	ns			
t_r, t_f	Rise and Fall Time	$V_O = 1 V_{PP}$		5		5		5				
t_p	Propagation Delay Time	$V_O = 1 V_{PP}$		6		6		6				
$i_{n(+)}$	Non-Inverting Input Noise Current Density	$f = 1 \text{ kHz}$		3		3		3	pA/ $\sqrt{\text{Hz}}$			
$i_{n(-)}$	Inverting Input Noise Current Density	$f = 1 \text{ kHz}$		16		16		16	pA/ $\sqrt{\text{Hz}}$			
e_n	Input Noise Voltage Density	$f = 1 \text{ kHz}$		4		4		4	pA/ $\sqrt{\text{Hz}}$			
	Second Harmonic Distortion	2 $V_{PP}, 10 \text{ MHz}$		–50		–50		–50	dBc			
	Third Harmonic Distortion	2 $V_{PP}, 10 \text{ MHz}$		–55		–55		–50				
	Differential Gain	$R_L = 150\Omega, A_V = +2, \text{NTSC}$		0.05%		0.05%		0.05%				
	Differential Phase	$R_L = 150\Omega, A_V = +2, \text{NTSC}$		0.04		0.04		0.04	Deg			

(1) Typical values represent the most likely parametric norm.

(2) All limits ensured at room temperature (standard type face) or at operating temperature extremes (**bold face type**).

(3) Measured from +25% to +75% of output waveform.

6.7 ±5V DC Electrical Characteristics

The following specifications apply for Supply Voltage = ±5V, $R_F = 820 \Omega$, and $R_L = 1 \text{ k}\Omega$ unless otherwise noted. **Boldface** limits apply at the temperature extremes.

PARAMETER	TEST CONDITIONS	LM6181AM		LM6181AI		LM6181I		UNIT
		TYP ⁽¹⁾	LIMIT ⁽²⁾	TYP ⁽¹⁾	LIMIT ⁽²⁾	TYP ⁽¹⁾	LIMIT ⁽²⁾	
V_{OS}	Input Offset Voltage	1.0	2.0 3.0	1.0	2.0 2.5	1.0	3.0 3.5	mV max
TC V_{OS}	Input Offset Voltage Drift	2.5		2.5		2.5		$\mu\text{V}/^\circ\text{C}$
I_B	Inverting Input Bias Current	5.0	10 22	5.0	10 22	5.0	17.5 27.0	μA max
	Non-Inverting Input Bias Current	0.25	1.5 1.5	0.25	1.5 1.5	0.25	3.0 5.0	
TC I_B	Inverting Input Bias Current Drift	50		50		50		nA/ $^\circ\text{C}$
	Non-Inverting Input Bias Current Drift	3.0		3.0		3.0		
I_B PSR	Inverting Input Bias Current Power Supply Rejection	$V_S = \pm 4.0\text{V}, \pm 6.0\text{V}$		$V_S = \pm 4.0\text{V}, \pm 6.0\text{V}$		$V_S = \pm 4.0\text{V}, \pm 6.0\text{V}$		$\mu\text{A}/\text{V}$ max
	Non-Inverting Input Bias Current Power Supply Rejection	0.3	0.5 0.5	0.3	0.5 0.5	0.3	1.0 1.0	
I_B CMR	Inverting Input Bias Current Common Mode Rejection	$-2.5\text{V} \leq V_{CM} \leq +2.5\text{V}$		$-2.5\text{V} \leq V_{CM} \leq +2.5\text{V}$		$-2.5\text{V} \leq V_{CM} \leq +2.5\text{V}$		
	Non-Inverting Input Bias Current Common Mode Rejection	0.05	0.5 0.5	0.05	0.5 0.5	0.05	0.5 0.5	
CMRR	Common Mode Rejection Ratio	$-2.5\text{V} \leq V_{CM} \leq +2.5\text{V}$		$-2.5\text{V} \leq V_{CM} \leq +2.5\text{V}$		$-2.5\text{V} \leq V_{CM} \leq +2.5\text{V}$		57
PSRR	Power Supply Rejection Ratio	$V_S = \pm 4.0\text{V}, \pm 6.0\text{V}$		$V_S = \pm 4.0\text{V}, \pm 6.0\text{V}$		$V_S = \pm 4.0\text{V}, \pm 6.0\text{V}$		50 47
R_O	Output Resistance	$A_V = -1, f = 300 \text{ kHz}$		$A_V = -1, f = 300 \text{ kHz}$		$A_V = -1, f = 300 \text{ kHz}$		80 70
R_{IN}	Non-Inverting Input Resistance	0.25		0.25		0.25		80 70
V_O	Output Voltage Swing	$R_L = 1 \text{ k}\Omega$		$R_L = 1 \text{ k}\Omega$		$R_L = 1 \text{ k}\Omega$		2.6
		$R_L = 100\Omega$		$R_L = 100\Omega$		$R_L = 100\Omega$		2.2
I_{SC}	Output Short Circuit Current	100	75 70	100	75 70	100	75 70	2.6 2.2
Z_T	Transimpedance	$R_L = 1 \text{ k}\Omega$		$R_L = 1 \text{ k}\Omega$		$R_L = 1 \text{ k}\Omega$		2.0 2.0
		$R_L = 100\Omega$		$R_L = 100\Omega$		$R_L = 100\Omega$		2.0 2.0
I_S	Supply Current	No Load, $V_O = 0\text{V}$		No Load, $V_O = 0\text{V}$		No Load, $V_O = 0\text{V}$		2.0 2.0
V_{CM}	Input Common Mode Voltage Range	$V^+ - 1.7$ $V^- + 1.7$		$V^+ - 1.7$ $V^- + 1.7$		$V^+ - 1.7$ $V^- + 1.7$		2.0 2.0

(1) Typical values represent the most likely parametric norm.

(2) All limits ensured at room temperature (standard type face) or at operating temperature extremes (**bold face type**).

6.8 ±5V AC Electrical Characteristics

The following specifications apply for Supply Voltage = ±5V, $R_F = 820 \Omega$, and $R_L = 1 \text{ k}\Omega$ unless otherwise noted. **Boldface** limits apply at the temperature extremes.

PARAMETER		TEST CONDITIONS	LM6181AM		LM6181AI		LM6181I		UNIT
			TYP ⁽¹⁾	LIMIT ⁽²⁾	TYP ⁽¹⁾	LIMIT ⁽²⁾	TYP ⁽¹⁾	LIMIT ⁽²⁾	
BW	Closed Loop Bandwidth –3 dB	$A_V = +2$	50		50		50		MHz min
		$A_V = +10$	40		40		40		
		$A_V = -1$	55	35	55	35	55	35	
		$A_V = -10$	35		35		35		
PBW	Power Bandwidth	$A_V = -1, V_O = 4 V_{PP}$	40		40		40		
SR	Slew Rate	$A_V = -1, V_O = \pm 2V, R_L = 150\Omega$ ⁽³⁾	500	375	500	375	500	375	V/ μ s min
t_s	Settling Time (0.1%)	$A_V = -1, V_O = \pm 2V, R_L = 150\Omega$	50		50		50		ns
t_r, t_f	Rise and Fall Time	$V_O = 1 V_{PP}$	8.5		8.5		8.5		
t_p	Propagation Delay Time	$V_O = 1 V_{PP}$	8		8		8		
$i_{n(+)}$	Non-Inverting Input Noise Current Density	$f = 1 \text{ kHz}$	3		3		3		pA/ $\sqrt{\text{Hz}}$
$i_{n(-)}$	Inverting Input Noise Current Density	$f = 1 \text{ kHz}$	16		16		16		pA/ $\sqrt{\text{Hz}}$
e_n	Input Noise Voltage Density	$f = 1 \text{ kHz}$	4		4		4		pA/ $\sqrt{\text{Hz}}$
	Second Harmonic Distortion	$2 V_{PP}, 10 \text{ MHz}$	-45		-45		-45		dBc
	Third Harmonic Distortion	$2 V_{PP}, 10 \text{ MHz}$	-55		-55		-55		
	Differential Gain	$R_L = 150 \Omega, A_V = +2, \text{NTSC}$	0.063%		0.063%		0.063%		
	Differential Phase	$R_L = 150 \Omega, A_V = +2, \text{NTSC}$	0.16		0.16		0.16		Deg

(1) Typical values represent the most likely parametric norm.

(2) All limits ensured at room temperature (standard type face) or at operating temperature extremes (**bold face type**).

(3) Measured from +25% to +75% of output waveform.

6.9 Typical Performance Characteristics

$T_A = 25^\circ\text{C}$ unless otherwise noted

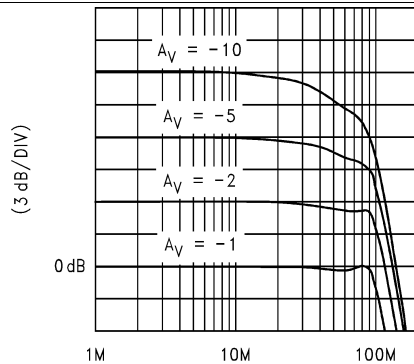

Figure 1. Closed-loop Frequency Response $V_S = \pm 15\text{V}$; $R_f = 820 \Omega$; $R_L = 1 \text{ k}\Omega$

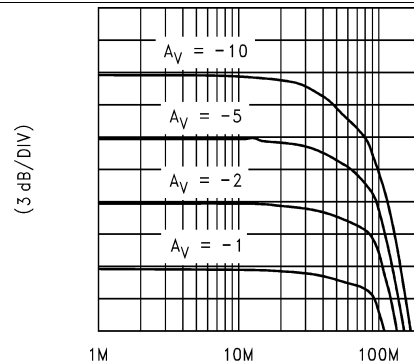

Figure 2. Closed-loop Frequency Response $V_S = \pm 15\text{V}$; $R_f = 820 \Omega$; $R_L = 150 \Omega$

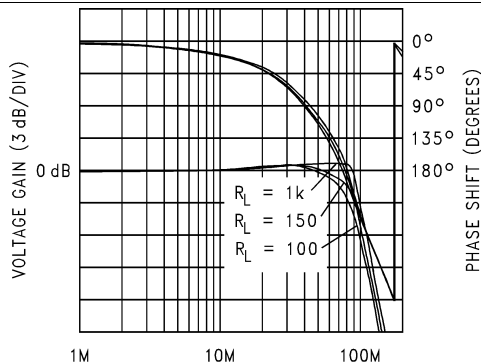

Figure 3. Unity Gain Frequency Response $V_S = \pm 15\text{V}$; $A_V = +1$; $R_f = 820 \Omega$

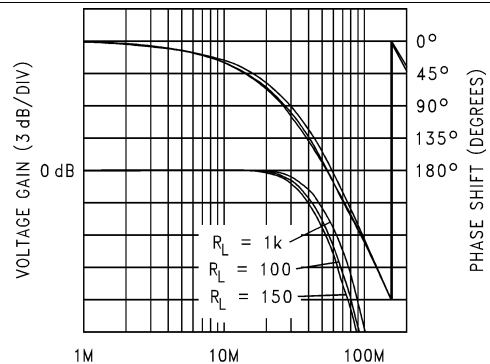

Figure 4. Unit Gain Frequency Response $V_S = \pm 5\text{V}$; $A_V = +1$; $R_f = 820 \Omega$

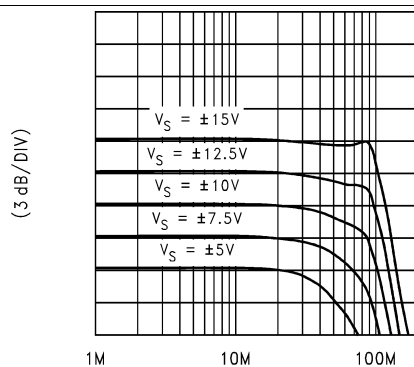

Figure 5. Frequency Response vs Supply Voltage $A_V = -1$; $R_f = 820 \Omega$; $R_L = 1 \text{ k}\Omega$

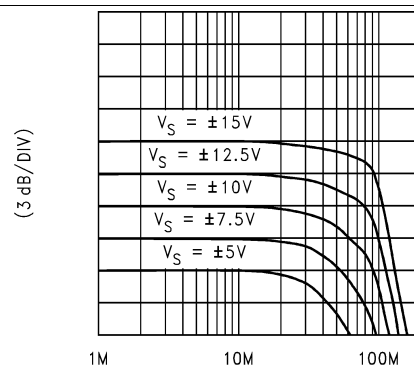
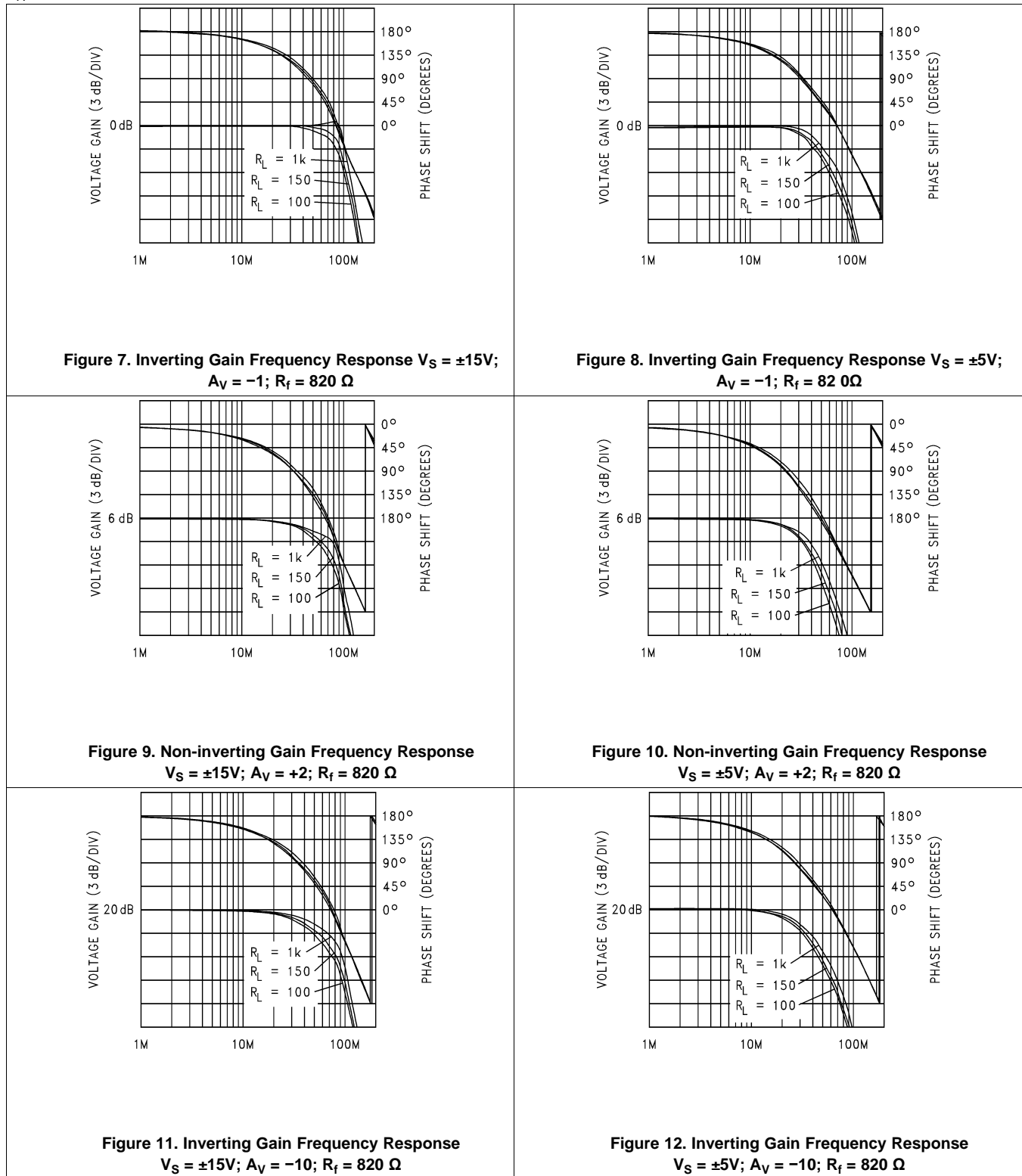

Figure 6. Frequency Response vs. Supply Voltage $A_V = -1$; $R_f = 820 \Omega$; $R_L = 150 \Omega$

Typical Performance Characteristics (continued)

T_A = 25°C unless otherwise noted



Typical Performance Characteristics (continued)

T_A = 25°C unless otherwise noted

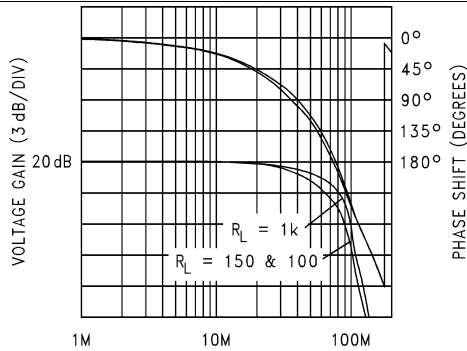

Figure 13. Non-inverting Gain Frequency Response
V_S = ±15V; A_V = +10; R_f = 820 Ω

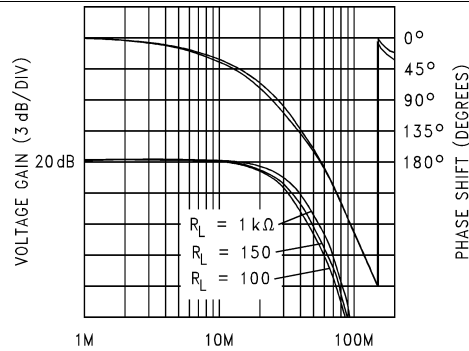

Figure 14. Non-inverting Gain Frequency Response
V_S = ±5V; A_V = +10; R_f = 820 Ω

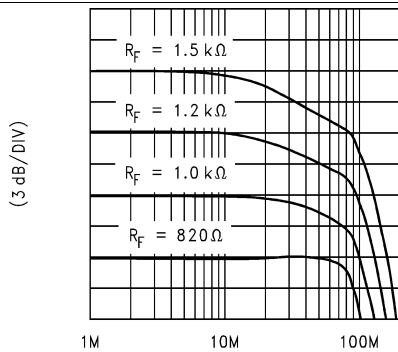

Figure 15. Non-inverting Gain Frequency Compensation
V_S = ±15V; A_V = +2; R_L = 150 Ω

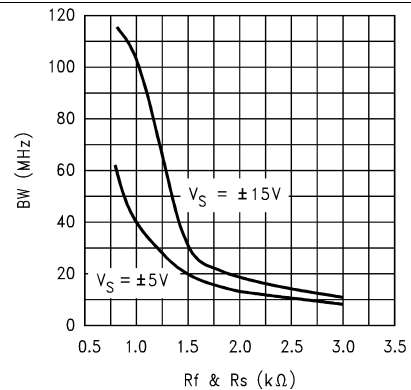

Figure 16. Bandwidth vs R_f & R_S A_V = -1, R_L = 1 kΩ

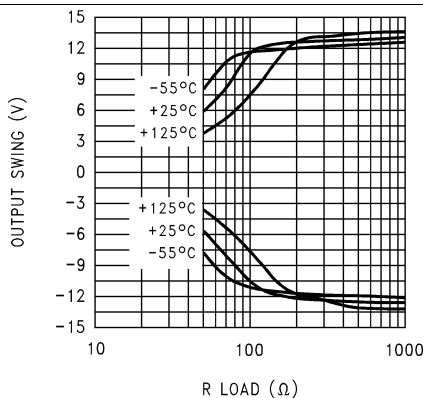

Figure 17. Output Swing vs R_{LOAD} Pulsed,
V_S = ±15V, I_{IN} = ±200 μA, V_{IN+} = 0V

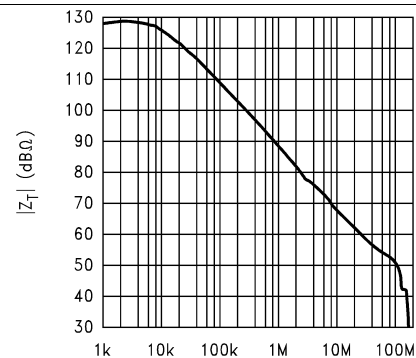

Figure 18. Transimpedance vs Frequency
V_S = ±15V R_L = 1 kΩ

Typical Performance Characteristics (continued)

T_A = 25°C unless otherwise noted

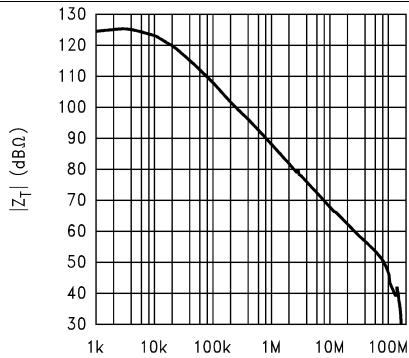

Figure 19. Transimpedance vs Frequency
V_S = ±15V R_L = 100Ω

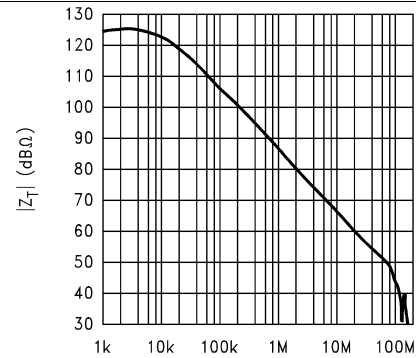

Figure 20. Transimpedance vs Frequency
V_S = ±5V R_L = 1 kΩ

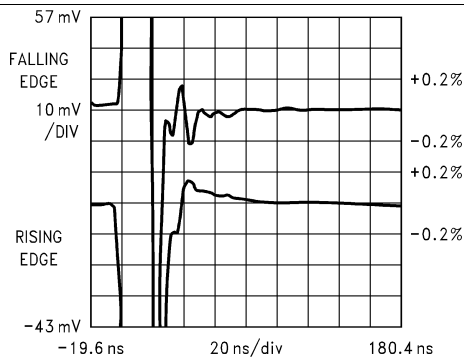

Figure 21. Settling Response V_S = ±15V;
R_L = 150Ω; V_O = ±5V; A_V = -1

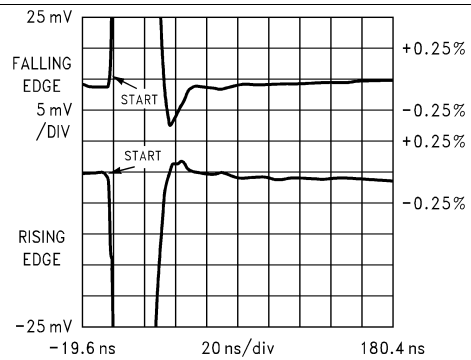

Figure 22. Settling Response V_S = ±5V;
R_L = 150Ω; V_O = ±2V; A_V = -1

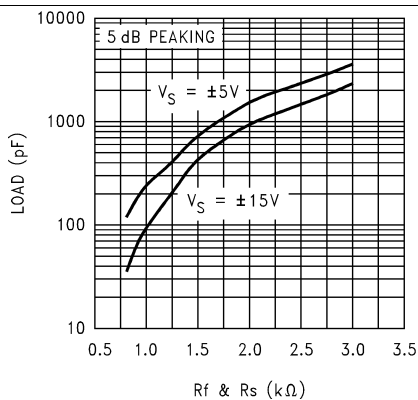

Figure 23. Suggested R_f and R_s for C_L A_V = -1; R_L = 150Ω

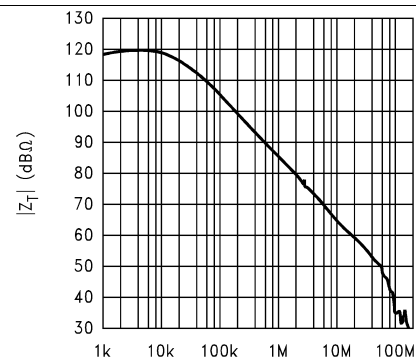

Figure 24. Transimpedance vs Frequency
V_S = ±5V R_L = 100Ω

Typical Performance Characteristics (continued)

T_A = 25°C unless otherwise noted

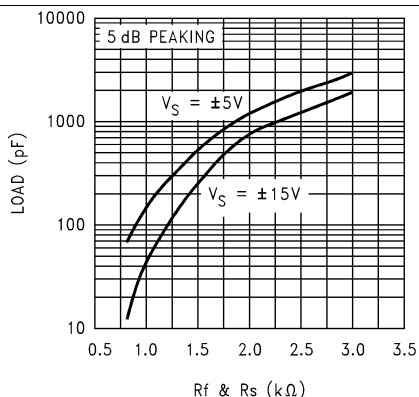

Figure 25. Suggested R_f and R_s for C_L A_v = -1

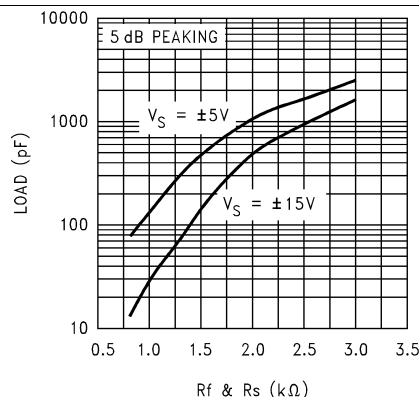

Figure 26. Suggested R_f and R_s for C_L A_v = +2; R_L = 150Ω

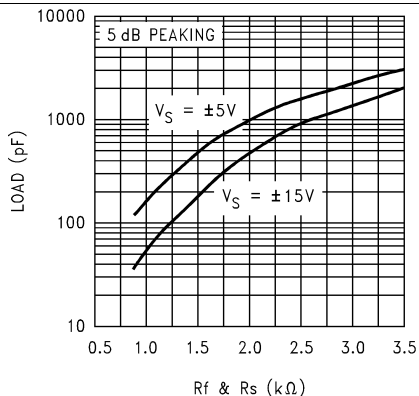

Figure 27. Suggested R_f and R_s for C_L A_v = +2

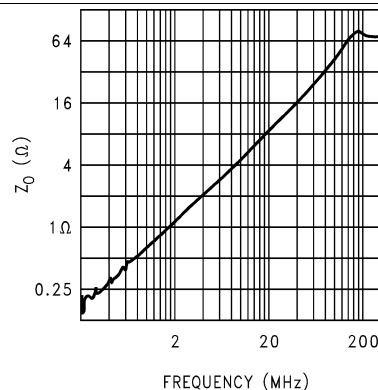

Figure 28. Output Impedance vs Freq
V_S = ±15V; A_v = -1 R_f = 820 Ω

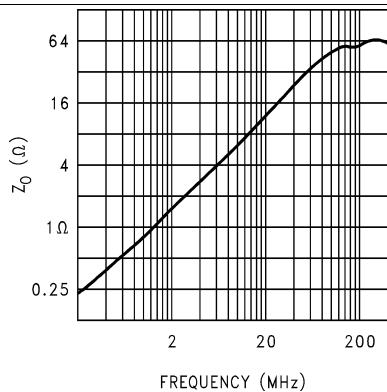

Figure 29. Output Impedance vs Freq
V_S = ±5V; A_v = -1 R_f = 820 Ω

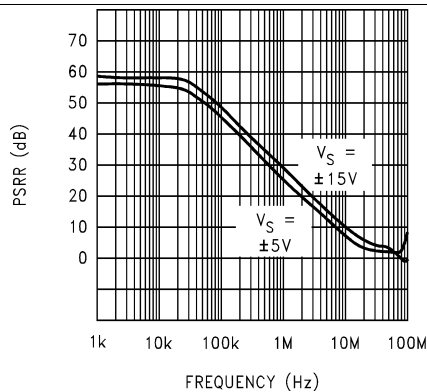

Figure 30. PSRR (V_S⁺) vs Frequency

Typical Performance Characteristics (continued)

T_A = 25°C unless otherwise noted

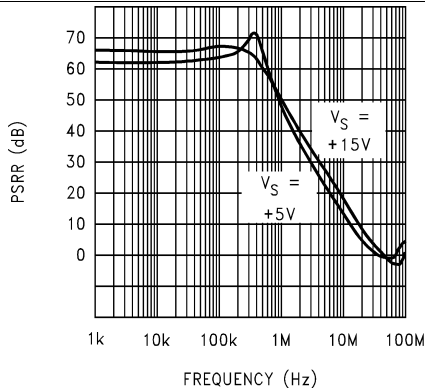

Figure 31. PSRR (V_S⁻) vs Frequency

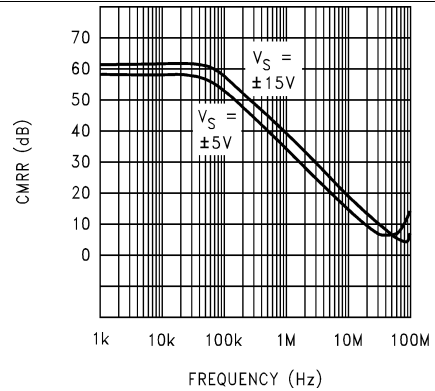

Figure 32. CMRR vs Frequency

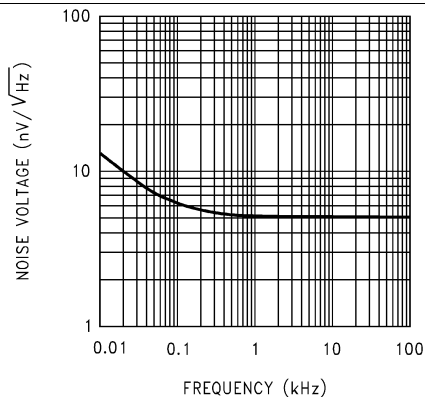

Figure 33. Input Voltage Noise vs Frequency

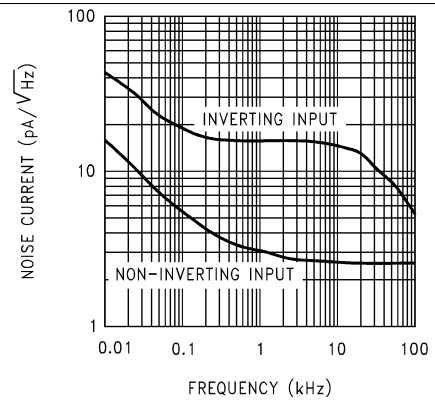

Figure 34. Input Current Noise vs Frequency

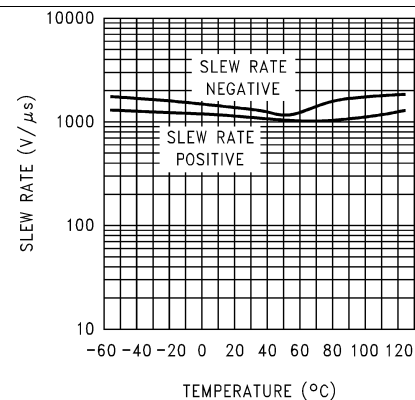

Figure 35. Slew Rate vs Temperature A_V = -1;
R_L = 150 Ω, V_S = ±15V

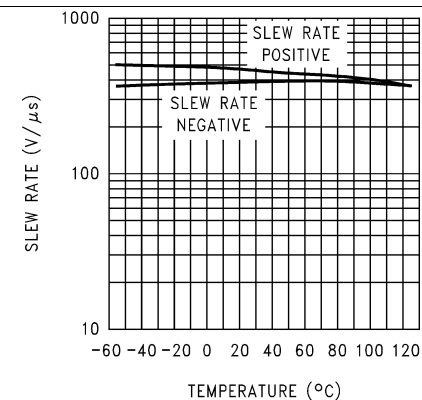

Figure 36. Slew Rate vs Temperature A_V = -1;
R_L = 150 Ω, V_S = ±5V

Typical Performance Characteristics (continued)

T_A = 25°C unless otherwise noted

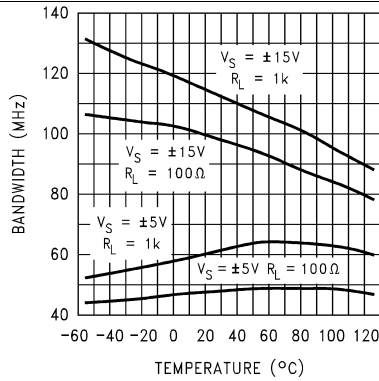

Figure 37. -3 dB Bandwidth vs Temperature A_V = -1

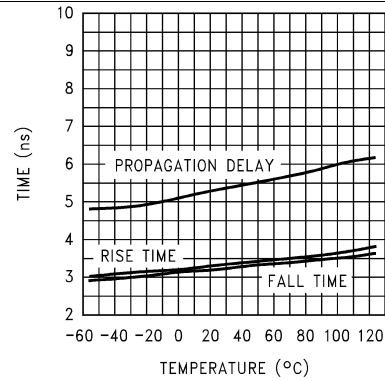

Figure 38. Small Signal Pulse response vs Temp, A_V = +1 V_S = ±15V; R_L = 1 kΩ

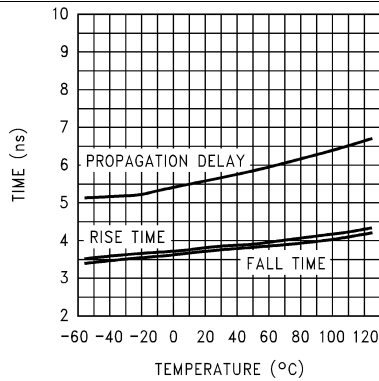

Figure 39. Small Signal Pulse Response vs Temp, A_V = +1 V_S = ±15V; R_L = 100Ω

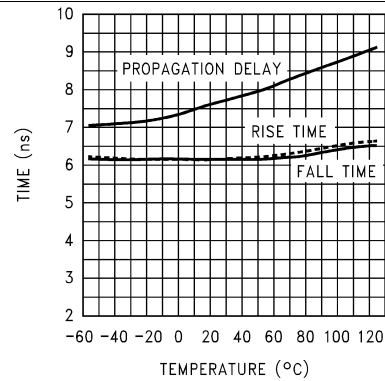

Figure 40. Small Signal Pulse Response vs Temp, A_V = +1 V_S = ±5V; R_L = 1 kΩ

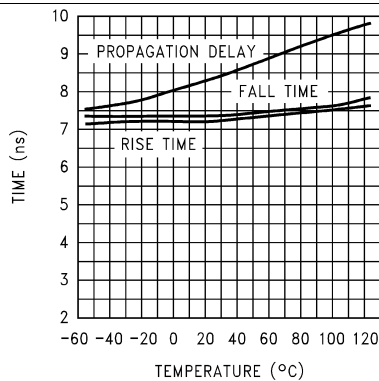

Figure 41. Small Signal Pulse Response vs Temp, A_V = +1 V_S = ±5V; R_L = 100Ω

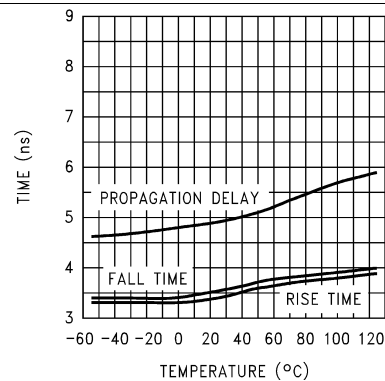

Figure 42. Small Signal Pulse Response vs Temp, A_V = -1 V_S = ±15V; R_L = 1 kΩ

Typical Performance Characteristics (continued)

T_A = 25°C unless otherwise noted

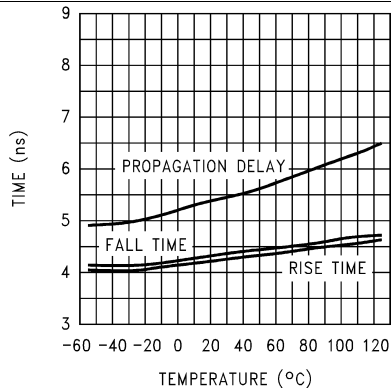

Figure 43. Small Signal Pulse Response vs Temp, $A_V = -1$ $V_S = \pm 15V$; $R_L = 100\Omega$

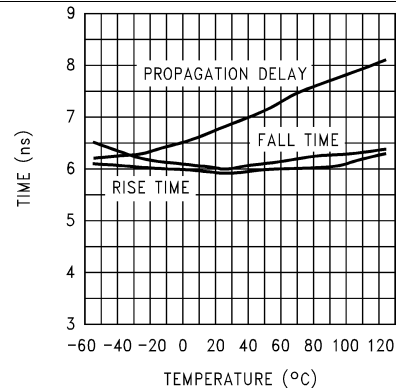

Figure 44. Small Signal Pulse Response vs Temp, $A_V = -1$ $V_S = \pm 5V$; $R_L = 1\text{ k}\Omega$

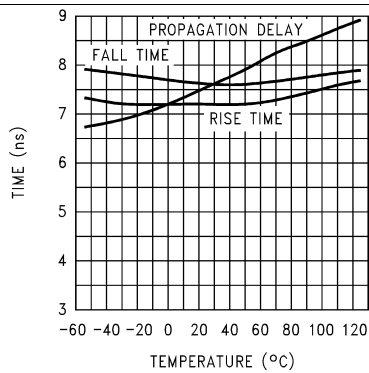

Figure 45. Small Signal Pulse Response vs Temp, $A_V = -1$ $V_S = \pm 5V$; $R_L = 100\Omega$

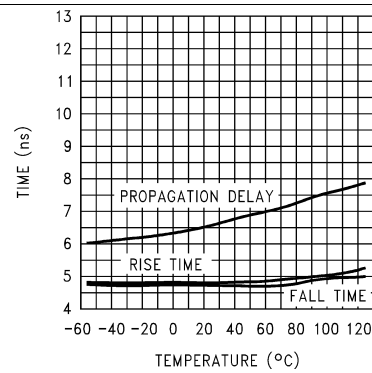

Figure 46. Small Signal Pulse Response vs Temp, $A_V = +2$ $V_S = \pm 15V$; $R_L = 1\text{ k}\Omega$

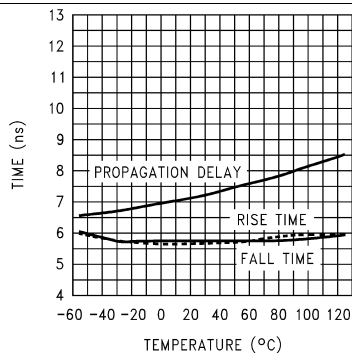

Figure 47. Small Signal Pulse Response vs Temp, $A_V = +2$ $V_S = \pm 15V$; $R_L = 100\Omega$

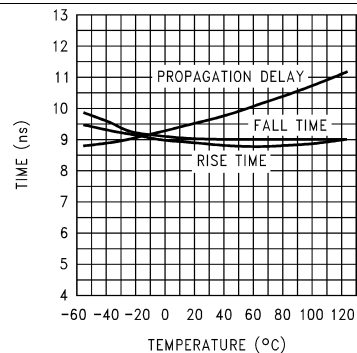

Figure 48. Small Signal Pulse Response vs Temp, $A_V = +2$ $V_S = \pm 5V$; $R_L = 1\text{ k}\Omega$

Typical Performance Characteristics (continued)

T_A = 25°C unless otherwise noted

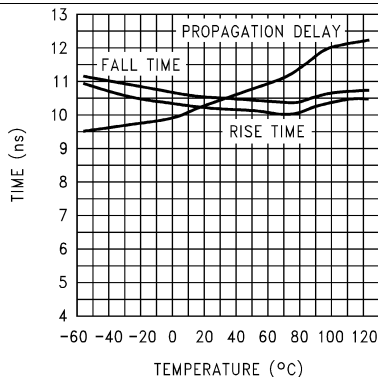

Figure 49. Small Signal Pulse Response vs Temp, $A_V = +2 V_S = \pm 5V; R_L = 100 \Omega$

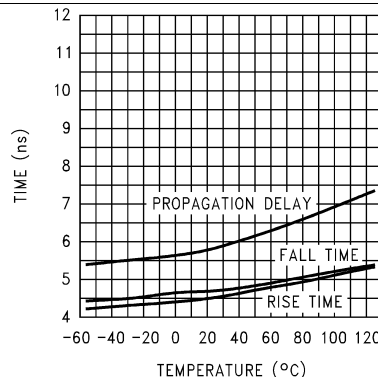

Figure 50. Small Signal Pulse Response vs Temp, $A_V = -10 V_S = \pm 15V; R_L = 1 k\Omega$

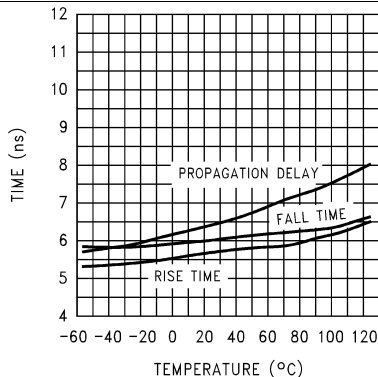

Figure 51. Small Signal Pulse Response vs Temp, $A_V = -10 V_S = \pm 15V; R_L = 100 \Omega$

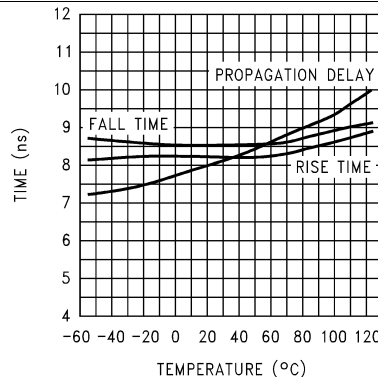

Figure 52. Small Signal Pulse Response vs Temp, $A_V = -10 V_S = \pm 5V; R_L = 1 k\Omega$

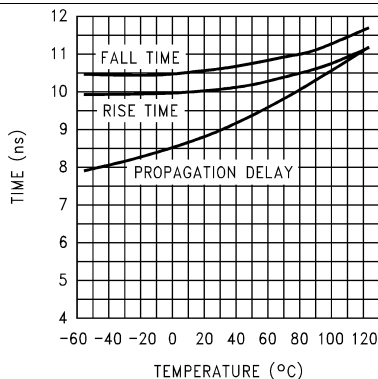

Figure 53. Small Signal Pulse Response vs Temp, $A_V = -10 V_S = \pm 5V; R_L = 100 \Omega$

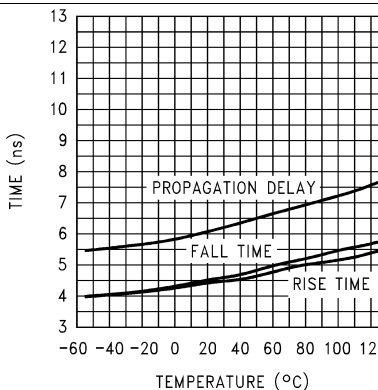

Figure 54. Small Signal Pulse Response vs Temp, $A_V = +10 V_S = \pm 15V; R_L = 1 k\Omega$

Typical Performance Characteristics (continued)

T_A = 25°C unless otherwise noted

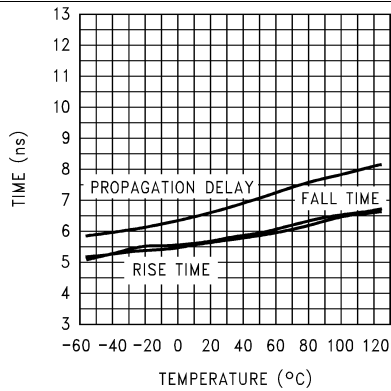

Figure 55. Small Signal Pulse Response vs Temp, $A_V = +10$ $V_S = \pm 15V$; $R_L = 100\Omega$

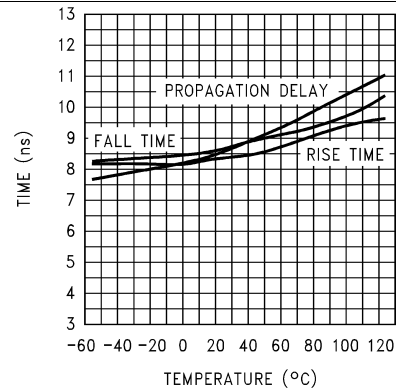

Figure 56. Small Signal Pulse Response vs Temp, $A_V = +10$ $V_S = \pm 5V$; $R_L = 1\text{ k}\Omega$

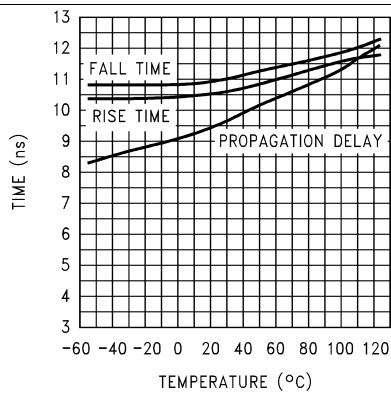

Figure 57. Small Signal Pulse Response vs Temp, $A_V = +10$ $V_S = \pm 5V$; $R_L = 100\Omega$

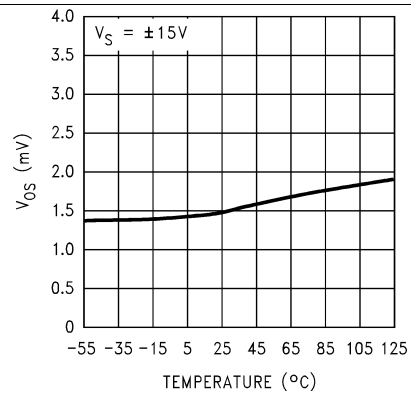

Figure 58. Offset Voltage vs temperature

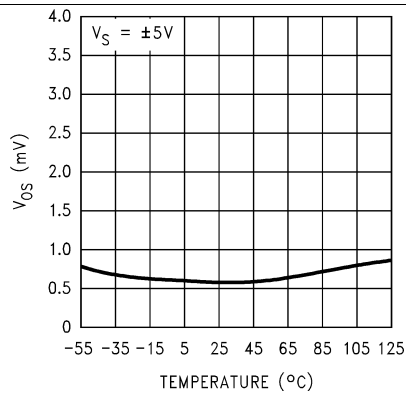

Figure 59. Offset Voltage vs Temperature

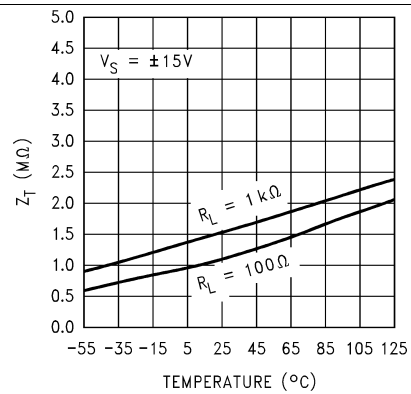

Figure 60. Transimpedance vs Temperature

Typical Performance Characteristics (continued)

T_A = 25°C unless otherwise noted

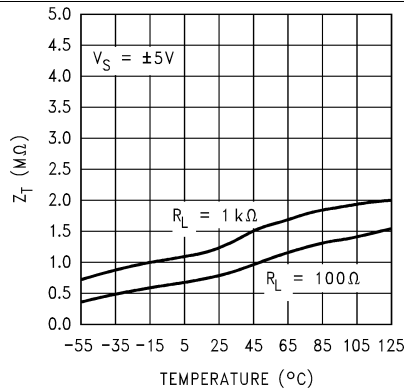

Figure 61. Transimpedance vs Temperature

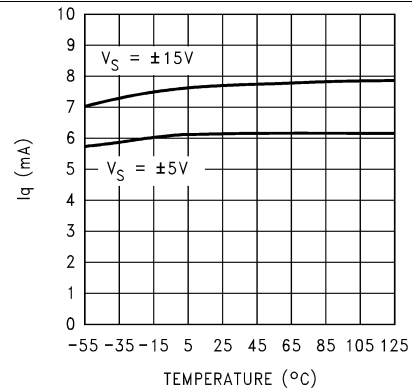

Figure 62. Quiescent Current vs Temperature

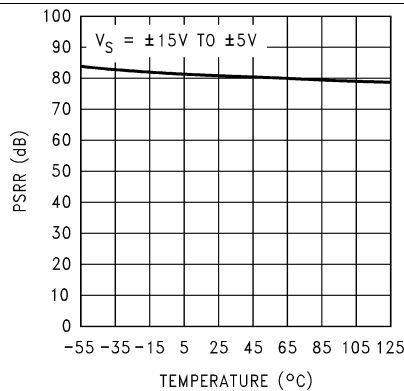

Figure 63. PSRR vs Temperature

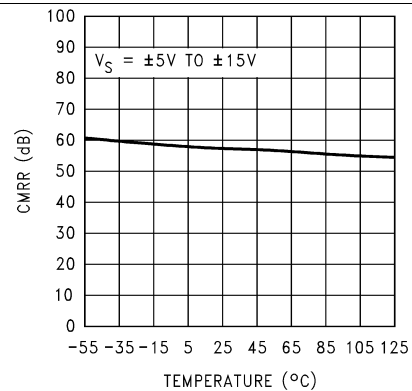

Figure 64. CMRR vs Temperature

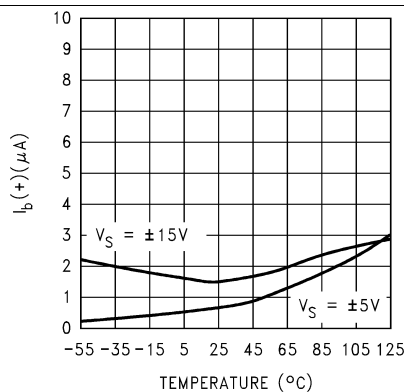

Figure 65. Non-inverting Bias Current vs Temperature

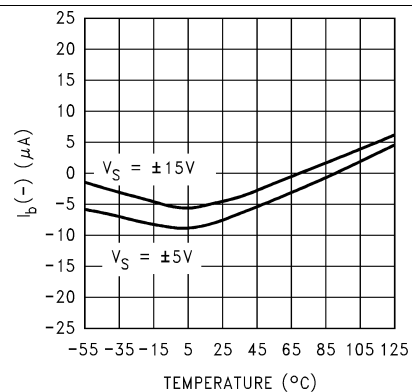

Figure 66. Inverting Bias Current vs Temperature

Typical Performance Characteristics (continued)

T_A = 25°C unless otherwise noted

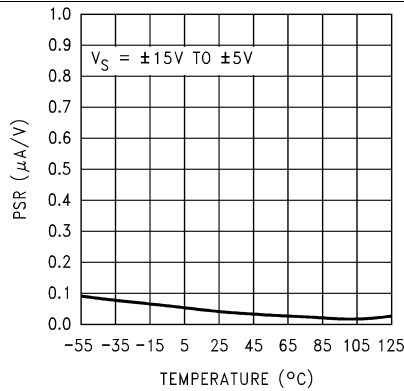

Figure 67. PSR I_{B(+)} vs Temperature

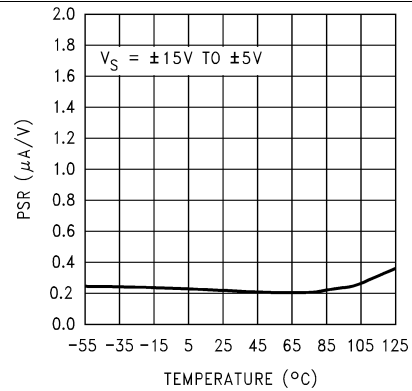

Figure 68. PSR I_{B(-)} vs Temperature

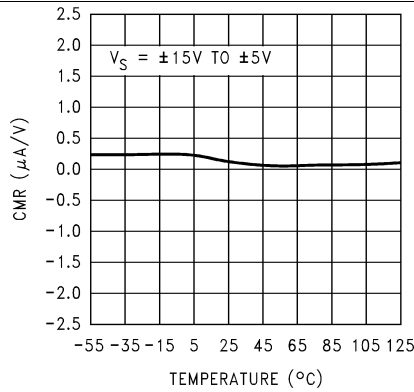

Figure 69. CMR I_{B(+)} vs Temperature

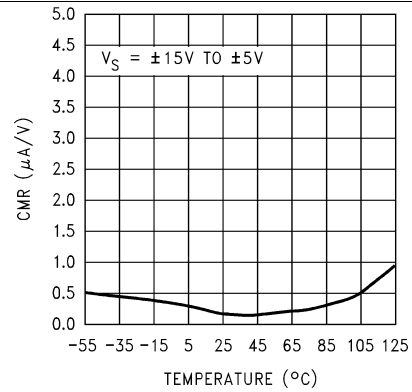

Figure 70. CMR I_{B(-)} vs Temperature

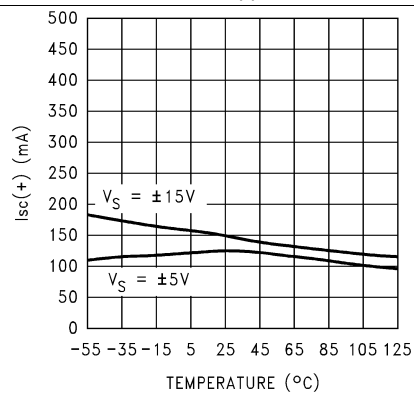

Figure 71. I_{SC(+)} vs Temperature

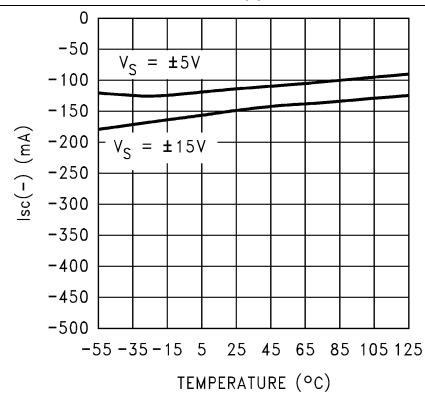

Figure 72. I_{SC(-)} vs Temperature

Typical Performance Characteristics (continued)

T_A = 25°C unless otherwise noted

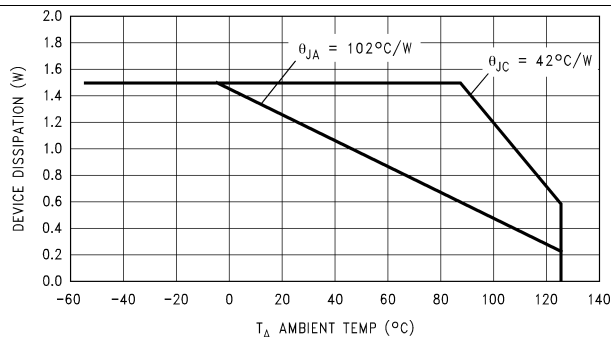
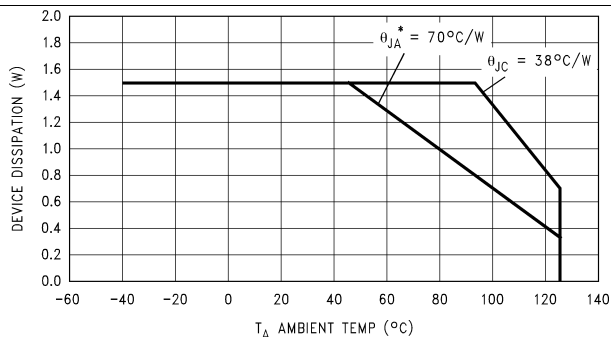

Figure 73. Absolute Maximum Power Derating: PDIP Package



*θ_{JA} = Thermal Resistance with 2 square inches of 1 ounce Copper tied to Pins 1, 8, 9 and 16.

Figure 74. Absolute Maximum Power Derating: SOIC-16 package

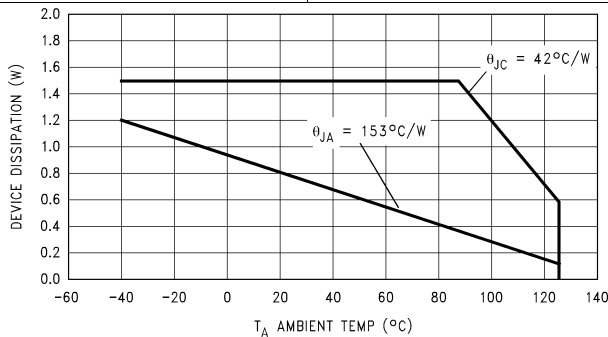

Figure 75. Absolute Maximum Power Derating: SOIC-8 package

7 Typical Applications

7.1 Current Feedback Topology

For a conventional voltage feedback amplifier the resulting small-signal bandwidth is inversely proportional to the desired gain to a first order approximation based on the gain-bandwidth concept. In contrast, the current feedback amplifier topology, such as the LM6181, transcends this limitation to offer a signal bandwidth that is relatively independent of the closed-loop gain. [Figure 76](#) and [Figure 77](#) illustrate that for closed loop gains of -1 and -5 the resulting pulse fidelity suggests quite similar bandwidths for both configurations.

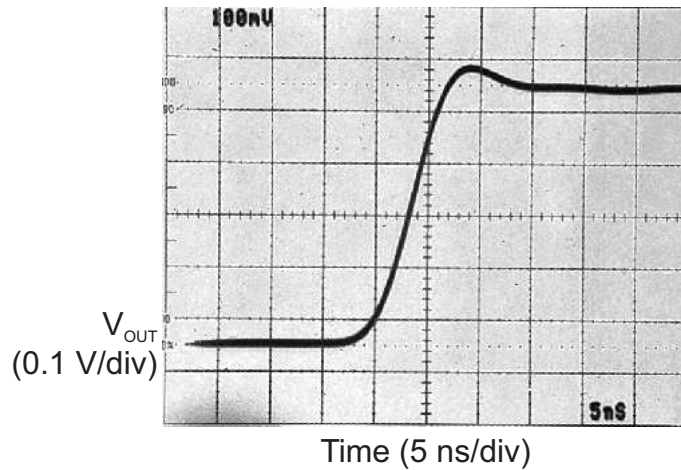
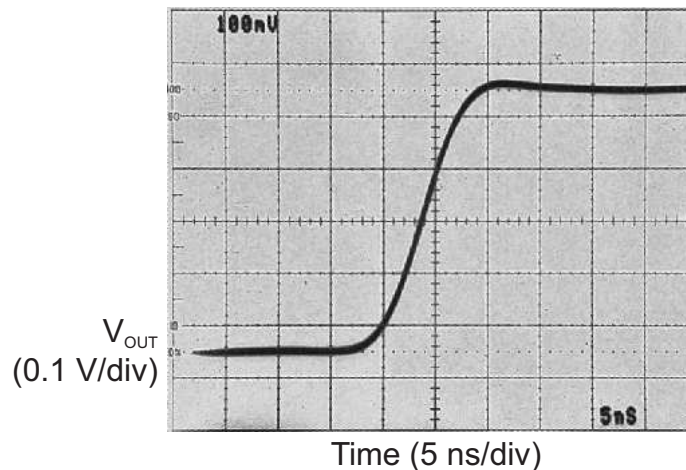

Figure 76. Step Response, $A_v = -1V/V$



Variation of Closed Loop Gain
from -1 to -5 Yields Similar Responses

Figure 77. Step Response, $A_v = -5V/V$

Current Feedback Topology (continued)

The closed-loop bandwidth of the LM6181 depends on the feedback resistance, R_f . Therefore, R_s and not R_f , must be varied to adjust for the desired closed-loop gain as in Figure 78.

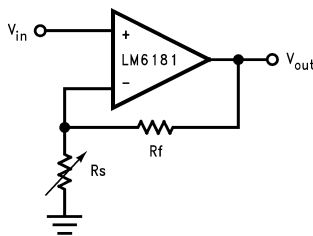

Figure 78. R_s Is Adjusted to Obtain the Desired Closed Loop Gain, A_{VCL}

7.2 Power Supply Bypassing and Layout Considerations

A fundamental requirement for high-speed amplifier design is adequate bypassing of the power supply. It is critical to maintain a wideband low-impedance to ground at the amplifiers supply pins to insure the fidelity of high speed amplifier transient signals. 10 μ F tantalum and 0.1 μ F ceramic bypass capacitors are recommended for each supply pin. The bypass capacitors should be placed as close to the amplifier pins as possible (0.5" or less).

7.3 Feedback Resistor Selection: R_f

Selecting the feedback resistor, R_f , is a dominant factor in compensating the LM6181. For general applications the LM6181 will maintain specified performance with an 820 Ω feedback resistor. Although this value will provide good results for most applications, it may be advantageous to adjust this value slightly. Consider, for instance, the effect on pulse responses with two different configurations where both the closed-loop gains are 2 and the feedback resistors are 820 Ω and 1640 Ω , respectively. Figure 79 and Figure 80 illustrate the effect of increasing R_f while maintaining the same closed-loop gain—the amplifier bandwidth decreases. Accordingly, larger feedback resistors can be used to slow down the LM6181 (see -3 dB bandwidth vs R_f typical curves) and reduce overshoot in the time domain response. Conversely, smaller feedback resistance values than 820 Ω can be used to compensate for the reduction of bandwidth at high closed loop gains, due to 2nd order effects. For example Figure 81 illustrates reducing R_f to 500 Ω to establish the desired small signal response in an amplifier configured for a closed loop gain of 25.

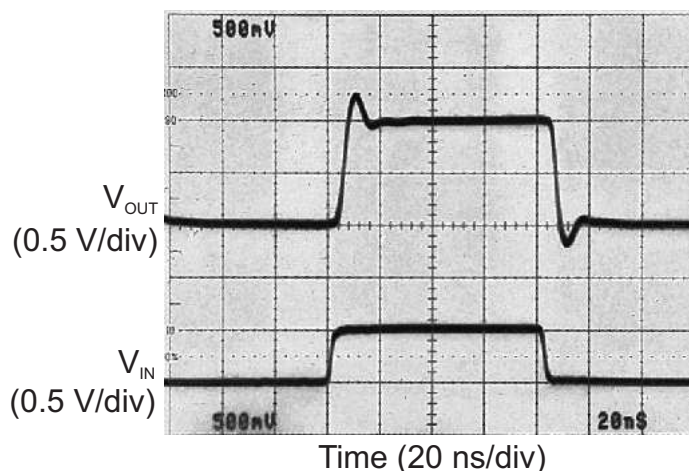
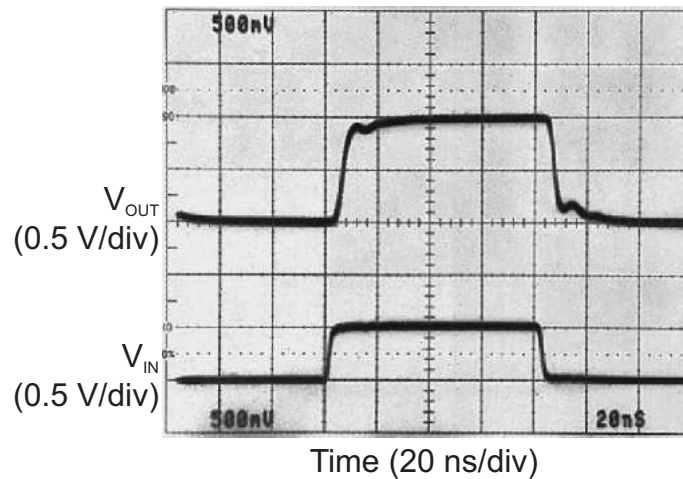

Figure 79. Step Response with $R_f = 820 \Omega$

Feedback Resistor Selection: R_f (continued)

Increasing Compensation with Increasing R_f

Figure 80. Step Response with $R_f = 1640 \Omega$

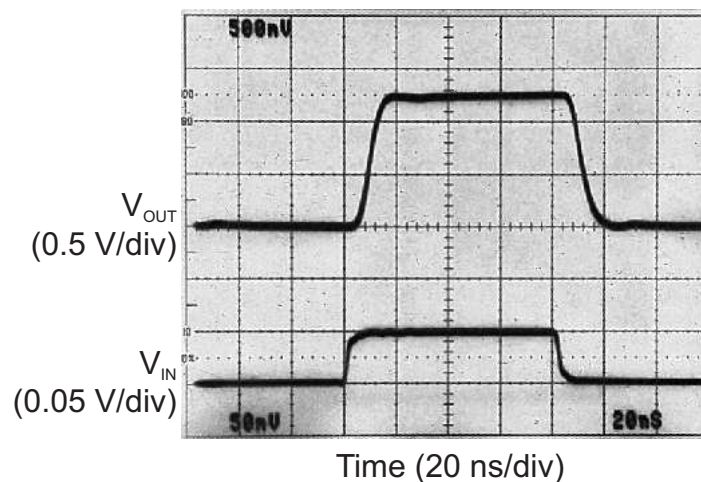

Figure 81. Reducing R_f for Large Closed Loop Gains, $R_f = 500 \Omega$

7.4 Slew Rate Considerations

The slew rate characteristics of current feedback amplifiers are different than traditional voltage feedback amplifiers. In voltage feedback amplifiers slew rate limiting or non-linear amplifier behavior is dominated by the finite availability of the 1st stage tail current charging the compensation capacitor. The slew rate of current feedback amplifiers, in contrast, is not constant. Transient current at the inverting input determines slew rate for both inverting and non-inverting gains. The non-inverting configuration slew rate is also determined by input stage limitations. Accordingly, variations of slew rates occur for different circuit topologies.

7.5 Driving Capacitive Loads

The LM6181 can drive significantly larger capacitive loads than many current feedback amplifiers. Although the LM6181 can directly drive as much as 100 pF without oscillating, the resulting response will be a function of the feedback resistor value. Figure 83 illustrates the small-signal pulse response of the LM6181 while driving a 50 pF load. Ringing persists for approximately 70 ns. To achieve pulse responses with less ringing either the feedback resistor can be increased (see Figure 23, Figure 25, and Figure 26), or resistive isolation can be used (10 Ω–51 Ω typically works well). Either technique, however, results in lowering the system bandwidth.

Figure 85 illustrates the improvement obtained with using a 47Ω isolation resistor.

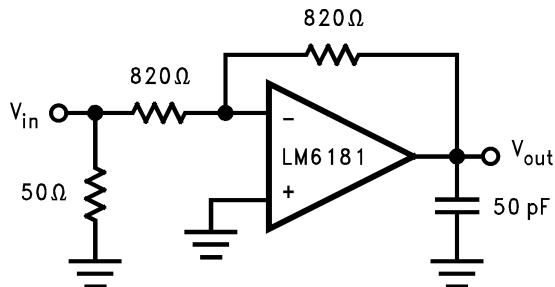

Figure 82. Cap Load Direct Drive

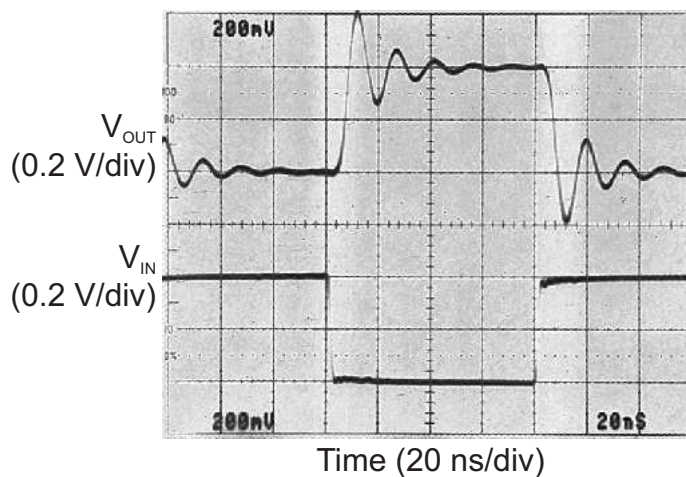

Figure 83. $A_V = -1$, LM6181 Can Directly Drive 50 pF of Load Capacitance with 70 ns of Ringing Resulting in Pulse Response

Driving Capacitive Loads (continued)

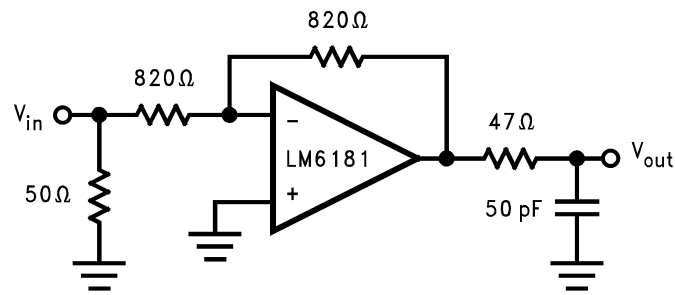
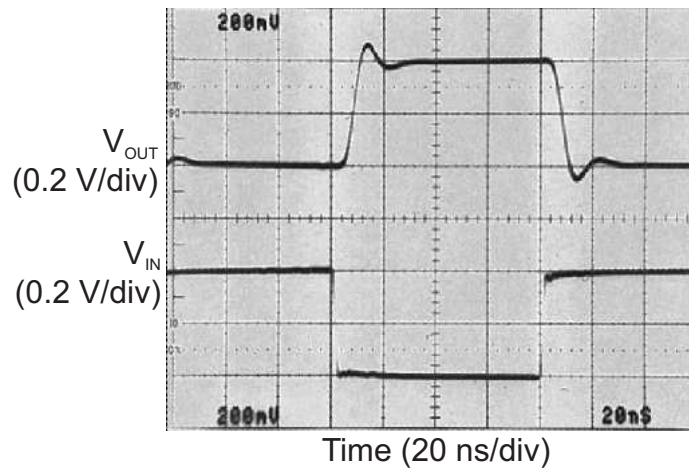

Figure 84. Cap Load Drive with Isolation Resistor



R_f and R_s Could Be Increased to Maintain $A_v = -1$ and Improve Pulse Response Characteristics.

Figure 85. Resistive Isolation of C_L Provides Higher Fidelity Pulse Response

7.6 Capacitive Feedback

For voltage feedback amplifiers it is quite common to place a small lead compensation capacitor in parallel with feedback resistance, R_f . This compensation serves to reduce the amplifier's peaking in the frequency domain which equivalently tames the transient response. To limit the bandwidth of current feedback amplifiers, do not use a capacitor across R_f . The dynamic impedance of capacitors in the feedback loop reduces the amplifier's stability. Instead, reduced peaking in the frequency response, and bandwidth limiting can be accomplished by adding an RC circuit, as illustrated in Figure 87.

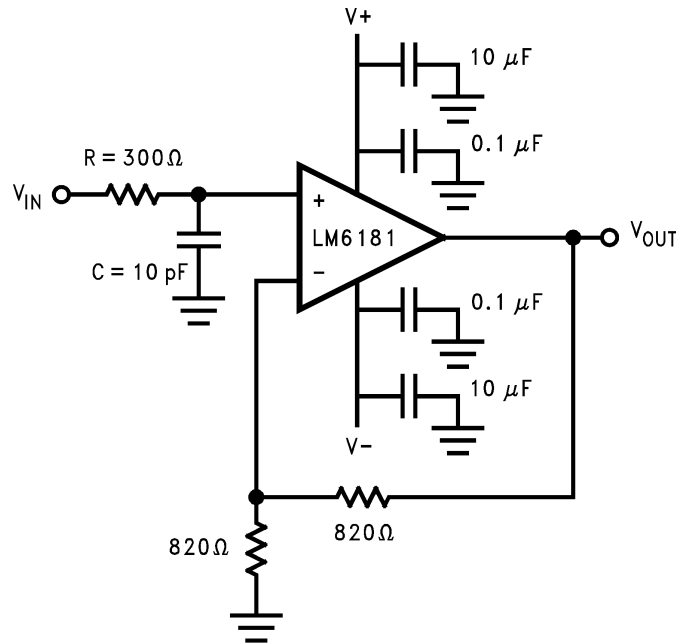

Figure 86. Using RC on Input to Affect Frequency Response

$$f_{-3\ \text{dB}} = \frac{1}{2\pi RC}$$

(1)

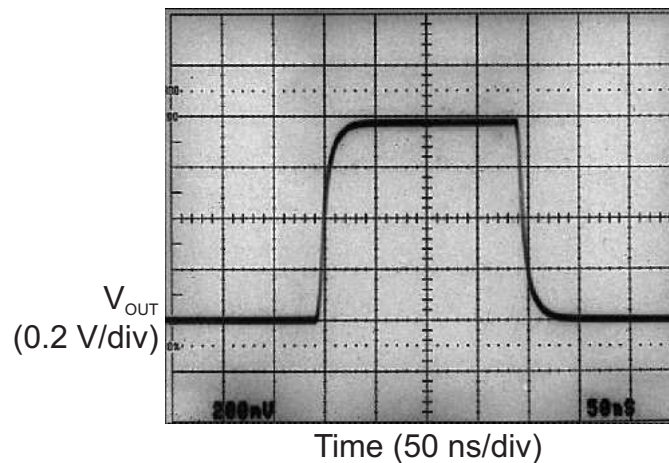

Figure 87. RC Limits Amplifier Bandwidth to 50 MHz, Eliminating Peaking in the Resulting Pulse Response

8 Application and Implementation

NOTE

Information in the following applications sections is not part of the TI component specification, and TI does not warrant its accuracy or completeness. TI's customers are responsible for determining suitability of components for their purposes. Customers should validate and test their design implementation to confirm system functionality.

8.1 Typical Application

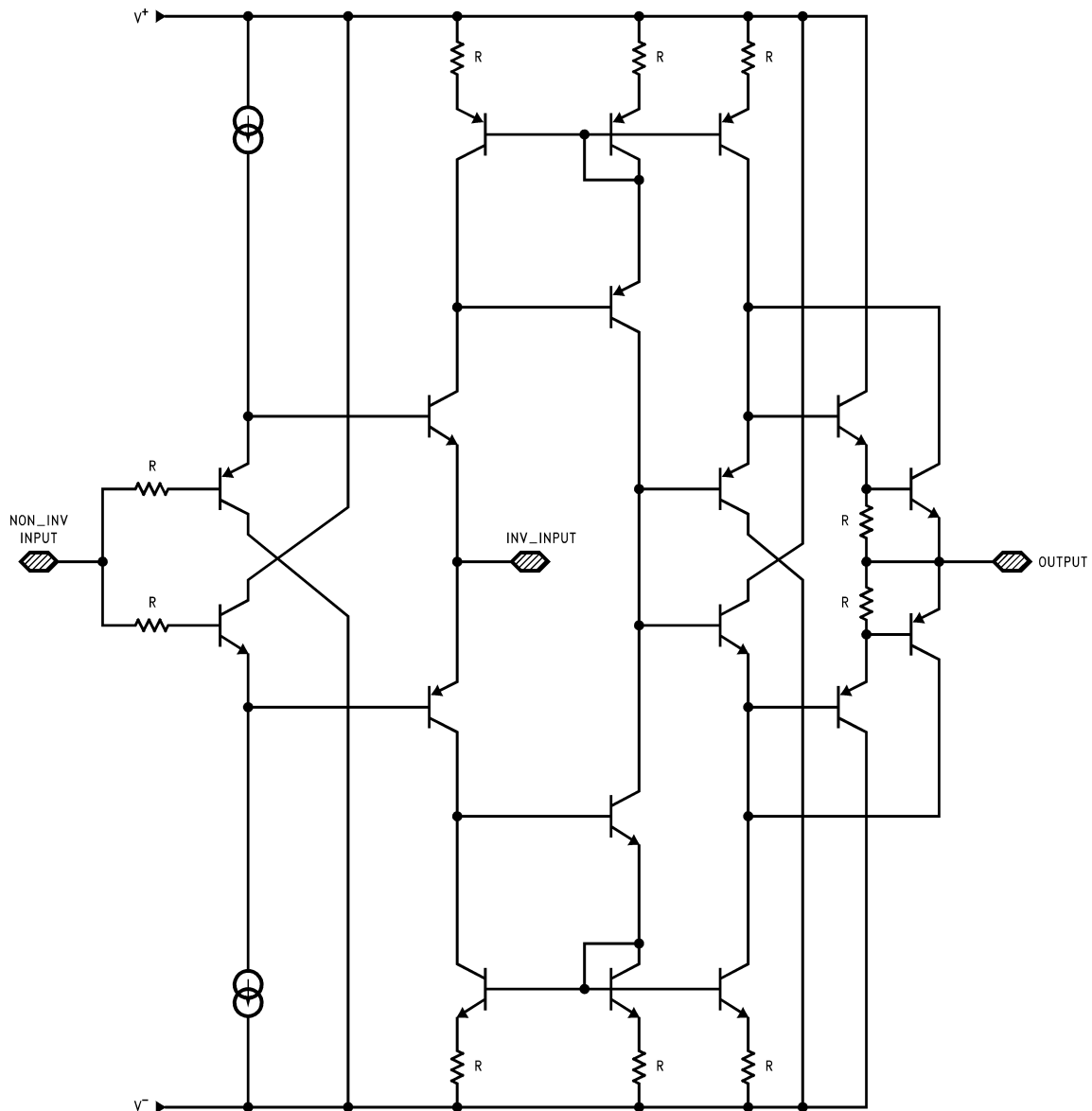

Figure 88. LM6181 Simplified Schematic

Typical Application (continued)

8.1.1 Typical Performance Characteristics

8.1.1.1 Overdrive Recovery

When the output or input voltage range of a high speed amplifier is exceeded, the amplifier must recover from an overdrive condition. The typical recovery times for open-loop, closed-loop, and input common-mode voltage range overdrive conditions are illustrated in [Figure 90](#), [Figure 92](#), and [Figure 93](#), respectively.

The open-loop circuit of [Figure 89](#) generates an overdrive response by allowing the $\pm 0.5\text{V}$ input to exceed the linear input range of the amplifier. Typical positive and negative overdrive recovery times shown in [Figure 90](#) are 5 ns and 25 ns, respectively.

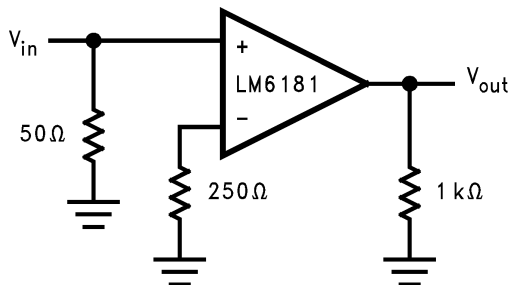

Figure 89. Open Loop Input Overdrive Test Circuit

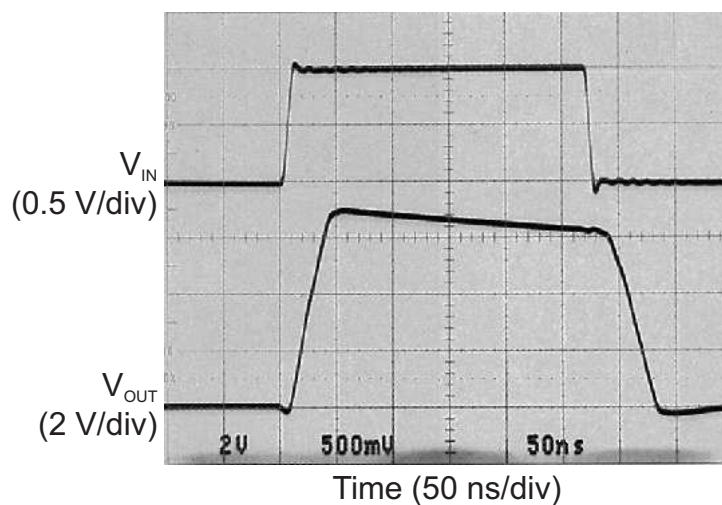

Figure 90. Open-Loop Overdrive Recovery Time of 5 ns, and 25 ns from Test Circuit in [Figure 89](#)

Typical Application (continued)

The large closed-loop gain configuration in [Figure 91](#) forces the amplifier output into overdrive. [Figure 92](#) displays the typical 30 ns recovery time to a linear output value.

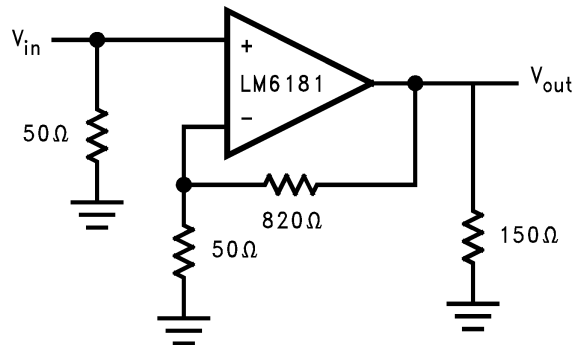

Figure 91. Overdrive Recovery Circuit under Large Closed Loop Gain Condition

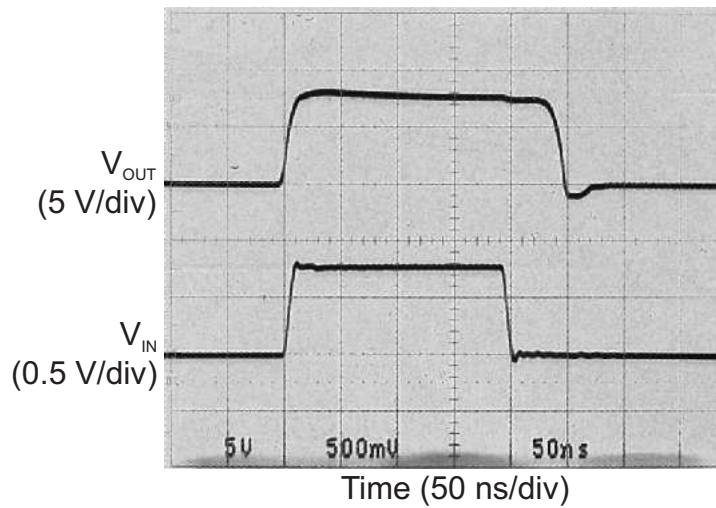

Figure 92. Closed-Loop Overdrive Recovery Time of 30 ns from Exceeding Output Voltage Range from Circuit in [Figure 91](#)

Typical Application (continued)

The common-mode input of the circuit in [Figure 91](#) is exceeded by a 5V pulse resulting in a typical recovery time of 310 ns shown in [Figure 93](#). The LM6181 supply voltage is $\pm 5V$.

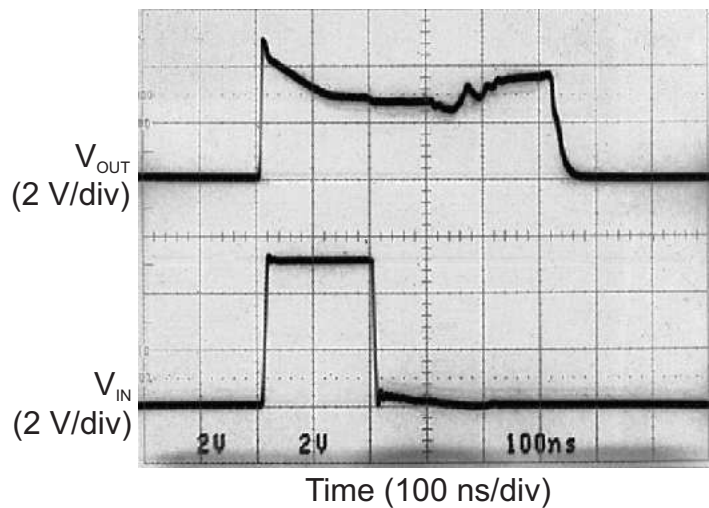

Figure 93. Exceptional Output Recovery from an Input that Exceeds the Common-Mode Range

9 Device and Documentation Support

9.1 Trademarks

VIP is a trademark of Texas Instruments.
All other trademarks are the property of their respective owners.

9.2 Electrostatic Discharge Caution



These devices have limited built-in ESD protection. The leads should be shorted together or the device placed in conductive foam during storage or handling to prevent electrostatic damage to the MOS gates.

9.3 Glossary

[SLYZ022](#) — *TI Glossary*.

This glossary lists and explains terms, acronyms, and definitions.

10 Mechanical, Packaging, and Orderable Information

The following pages include mechanical, packaging, and orderable information. This information is the most current data available for the designated devices. This data is subject to change without notice and revision of this document. For browser-based versions of this data sheet, refer to the left-hand navigation.

PACKAGING INFORMATION

Orderable Device	Status (1)	Package Type	Package Drawing	Pins	Package Qty	Eco Plan (2)	Lead/Ball Finish (6)	MSL Peak Temp (3)	Op Temp (°C)	Device Marking (4/5)	Samples
LM6181IM-8/NOPB	LIFEBUY	SOIC	D	8	95	Green (RoHS & no Sb/Br)	CU SN	Level-1-260C-UNLIM	-40 to 85	LM618 1IM8	
LM6181IMX-8/NOPB	LIFEBUY	SOIC	D	8	2500	Green (RoHS & no Sb/Br)	CU SN	Level-1-260C-UNLIM	-40 to 85	LM618 1IM8	
LM6181IN/NOPB	LIFEBUY	PDIP	P	8	40	Green (RoHS & no Sb/Br)	CU SN	Level-1-NA-UNLIM	-40 to 85	LM6181IN	

(1) The marketing status values are defined as follows:

ACTIVE: Product device recommended for new designs.

LIFEBUY: TI has announced that the device will be discontinued, and a lifetime-buy period is in effect.

NRND: Not recommended for new designs. Device is in production to support existing customers, but TI does not recommend using this part in a new design.

PREVIEW: Device has been announced but is not in production. Samples may or may not be available.

OBsolete: TI has discontinued the production of the device.

(2) **RoHS:** TI defines "RoHS" to mean semiconductor products that are compliant with the current EU RoHS requirements for all 10 RoHS substances, including the requirement that RoHS substance do not exceed 0.1% by weight in homogeneous materials. Where designed to be soldered at high temperatures, "RoHS" products are suitable for use in specified lead-free processes. TI may reference these types of products as "Pb-Free".

RoHS Exempt: TI defines "RoHS Exempt" to mean products that contain lead but are compliant with EU RoHS pursuant to a specific EU RoHS exemption.

Green: TI defines "Green" to mean the content of Chlorine (Cl) and Bromine (Br) based flame retardants meet JS709B low halogen requirements of <=1000ppm threshold. Antimony trioxide based flame retardants must also meet the <=1000ppm threshold requirement.

(3) MSL, Peak Temp. - The Moisture Sensitivity Level rating according to the JEDEC industry standard classifications, and peak solder temperature.

(4) There may be additional marking, which relates to the logo, the lot trace code information, or the environmental category on the device.

(5) Multiple Device Markings will be inside parentheses. Only one Device Marking contained in parentheses and separated by a "-" will appear on a device. If a line is indented then it is a continuation of the previous line and the two combined represent the entire Device Marking for that device.

(6) Lead/Ball Finish - Orderable Devices may have multiple material finish options. Finish options are separated by a vertical ruled line. Lead/Ball Finish values may wrap to two lines if the finish value exceeds the maximum column width.

Important Information and Disclaimer: The information provided on this page represents TI's knowledge and belief as of the date that it is provided. TI bases its knowledge and belief on information provided by third parties, and makes no representation or warranty as to the accuracy of such information. Efforts are underway to better integrate information from third parties. TI has taken and continues to take reasonable steps to provide representative and accurate information but may not have conducted destructive testing or chemical analysis on incoming materials and chemicals. TI and TI suppliers consider certain information to be proprietary, and thus CAS numbers and other limited information may not be available for release.

In no event shall TI's liability arising out of such information exceed the total purchase price of the TI part(s) at issue in this document sold by TI to Customer on an annual basis.

TAPE AND REEL INFORMATION

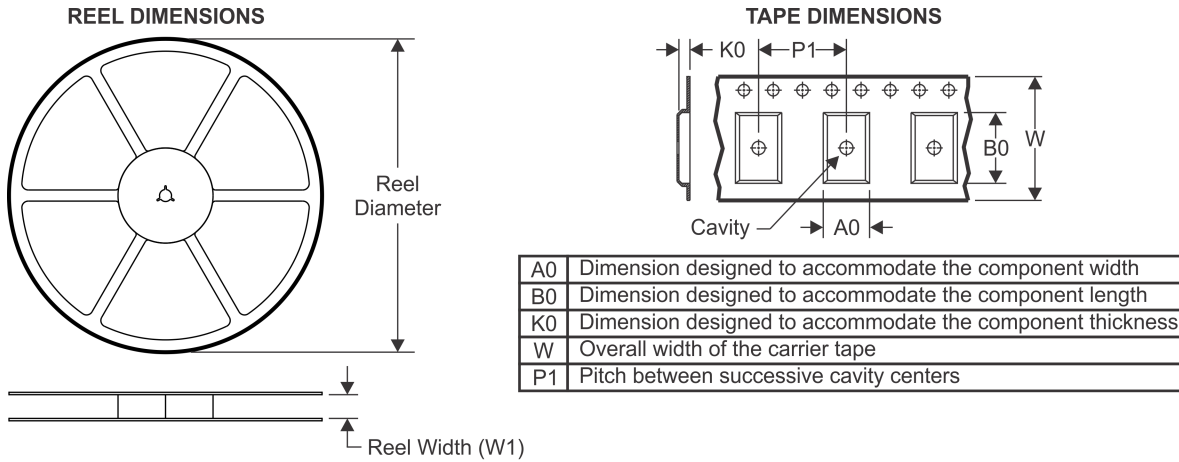

QUADRANT ASSIGNMENTS FOR PIN 1 ORIENTATION IN TAPE



*All dimensions are nominal

Device	Package Type	Package Drawing	Pins	SPQ	Reel Diameter (mm)	Reel Width W1 (mm)	A0 (mm)	B0 (mm)	K0 (mm)	P1 (mm)	W (mm)	Pin1 Quadrant
LM6181IMX-8/NOPB	SOIC	D	8	2500	330.0	12.4	6.5	5.4	2.0	8.0	12.0	Q1

TAPE AND REEL BOX DIMENSIONS



*All dimensions are nominal

Device	Package Type	Package Drawing	Pins	SPQ	Length (mm)	Width (mm)	Height (mm)
LM6181IMX-8/NOPB	SOIC	D	8	2500	367.0	367.0	35.0

D (R-PDSO-G8)

PLASTIC SMALL OUTLINE



- NOTES:
- A. All linear dimensions are in inches (millimeters).
 - B. This drawing is subject to change without notice.
 - $\triangle C$ Body length does not include mold flash, protrusions, or gate burrs. Mold flash, protrusions, or gate burrs shall not exceed 0.006 (0,15) each side.
 - $\triangle D$ Body width does not include interlead flash. Interlead flash shall not exceed 0.017 (0,43) each side.
 - E. Reference JEDEC MS-012 variation AA.

P (R-PDIP-T8)

PLASTIC DUAL-IN-LINE PACKAGE



4040082/E 04/2010

- NOTES:
- A. All linear dimensions are in inches (millimeters).
 - B. This drawing is subject to change without notice.
 - C. Falls within JEDEC MS-001 variation BA.

IMPORTANT NOTICE

Texas Instruments Incorporated (TI) reserves the right to make corrections, enhancements, improvements and other changes to its semiconductor products and services per JESD46, latest issue, and to discontinue any product or service per JESD48, latest issue. Buyers should obtain the latest relevant information before placing orders and should verify that such information is current and complete.

TI's published terms of sale for semiconductor products (<http://www.ti.com/sc/docs/stdterms.htm>) apply to the sale of packaged integrated circuit products that TI has qualified and released to market. Additional terms may apply to the use or sale of other types of TI products and services.

Reproduction of significant portions of TI information in TI data sheets is permissible only if reproduction is without alteration and is accompanied by all associated warranties, conditions, limitations, and notices. TI is not responsible or liable for such reproduced documentation. Information of third parties may be subject to additional restrictions. Resale of TI products or services with statements different from or beyond the parameters stated by TI for that product or service voids all express and any implied warranties for the associated TI product or service and is an unfair and deceptive business practice. TI is not responsible or liable for any such statements.

Buyers and others who are developing systems that incorporate TI products (collectively, "Designers") understand and agree that Designers remain responsible for using their independent analysis, evaluation and judgment in designing their applications and that Designers have full and exclusive responsibility to assure the safety of Designers' applications and compliance of their applications (and of all TI products used in or for Designers' applications) with all applicable regulations, laws and other applicable requirements. Designer represents that, with respect to their applications, Designer has all the necessary expertise to create and implement safeguards that (1) anticipate dangerous consequences of failures, (2) monitor failures and their consequences, and (3) lessen the likelihood of failures that might cause harm and take appropriate actions. Designer agrees that prior to using or distributing any applications that include TI products, Designer will thoroughly test such applications and the functionality of such TI products as used in such applications.

TI's provision of technical, application or other design advice, quality characterization, reliability data or other services or information, including, but not limited to, reference designs and materials relating to evaluation modules, (collectively, "TI Resources") are intended to assist designers who are developing applications that incorporate TI products; by downloading, accessing or using TI Resources in any way, Designer (individually or, if Designer is acting on behalf of a company, Designer's company) agrees to use any particular TI Resource solely for this purpose and subject to the terms of this Notice.

TI's provision of TI Resources does not expand or otherwise alter TI's applicable published warranties or warranty disclaimers for TI products, and no additional obligations or liabilities arise from TI providing such TI Resources. TI reserves the right to make corrections, enhancements, improvements and other changes to its TI Resources. TI has not conducted any testing other than that specifically described in the published documentation for a particular TI Resource.

Designer is authorized to use, copy and modify any individual TI Resource only in connection with the development of applications that include the TI product(s) identified in such TI Resource. NO OTHER LICENSE, EXPRESS OR IMPLIED, BY ESTOPPEL OR OTHERWISE TO ANY OTHER TI INTELLECTUAL PROPERTY RIGHT, AND NO LICENSE TO ANY TECHNOLOGY OR INTELLECTUAL PROPERTY RIGHT OF TI OR ANY THIRD PARTY IS GRANTED HEREIN, including but not limited to any patent right, copyright, mask work right, or other intellectual property right relating to any combination, machine, or process in which TI products or services are used. Information regarding or referencing third-party products or services does not constitute a license to use such products or services, or a warranty or endorsement thereof. Use of TI Resources may require a license from a third party under the patents or other intellectual property of the third party, or a license from TI under the patents or other intellectual property of TI.

TI RESOURCES ARE PROVIDED "AS IS" AND WITH ALL FAULTS. TI DISCLAIMS ALL OTHER WARRANTIES OR REPRESENTATIONS, EXPRESS OR IMPLIED, REGARDING RESOURCES OR USE THEREOF, INCLUDING BUT NOT LIMITED TO ACCURACY OR COMPLETENESS, TITLE, ANY EPIDEMIC FAILURE WARRANTY AND ANY IMPLIED WARRANTIES OF MERCHANTABILITY, FITNESS FOR A PARTICULAR PURPOSE, AND NON-INFRINGEMENT OF ANY THIRD PARTY INTELLECTUAL PROPERTY RIGHTS. TI SHALL NOT BE LIABLE FOR AND SHALL NOT DEFEND OR INDEMNIFY DESIGNER AGAINST ANY CLAIM, INCLUDING BUT NOT LIMITED TO ANY INFRINGEMENT CLAIM THAT RELATES TO OR IS BASED ON ANY COMBINATION OF PRODUCTS EVEN IF DESCRIBED IN TI RESOURCES OR OTHERWISE. IN NO EVENT SHALL TI BE LIABLE FOR ANY ACTUAL, DIRECT, SPECIAL, COLLATERAL, INDIRECT, PUNITIVE, INCIDENTAL, CONSEQUENTIAL OR EXEMPLARY DAMAGES IN CONNECTION WITH OR ARISING OUT OF TI RESOURCES OR USE THEREOF, AND REGARDLESS OF WHETHER TI HAS BEEN ADVISED OF THE POSSIBILITY OF SUCH DAMAGES.

Unless TI has explicitly designated an individual product as meeting the requirements of a particular industry standard (e.g., ISO/TS 16949 and ISO 26262), TI is not responsible for any failure to meet such industry standard requirements.

Where TI specifically promotes products as facilitating functional safety or as compliant with industry functional safety standards, such products are intended to help enable customers to design and create their own applications that meet applicable functional safety standards and requirements. Using products in an application does not by itself establish any safety features in the application. Designers must ensure compliance with safety-related requirements and standards applicable to their applications. Designer may not use any TI products in life-critical medical equipment unless authorized officers of the parties have executed a special contract specifically governing such use. Life-critical medical equipment is medical equipment where failure of such equipment would cause serious bodily injury or death (e.g., life support, pacemakers, defibrillators, heart pumps, neurostimulators, and implantables). Such equipment includes, without limitation, all medical devices identified by the U.S. Food and Drug Administration as Class III devices and equivalent classifications outside the U.S.

TI may expressly designate certain products as completing a particular qualification (e.g., Q100, Military Grade, or Enhanced Product). Designers agree that it has the necessary expertise to select the product with the appropriate qualification designation for their applications and that proper product selection is at Designers' own risk. Designers are solely responsible for compliance with all legal and regulatory requirements in connection with such selection.

Designer will fully indemnify TI and its representatives against any damages, costs, losses, and/or liabilities arising out of Designer's non-compliance with the terms and provisions of this Notice.