

# LMC7111 Tiny CMOS Operational Amplifier with Rail-to-Rail Input and Output

Check for Samples: [LMC7111](#)

## FEATURES

- **Tiny 5-Pin SOT-23 Package Saves Space**
- **Very Wide Common Mode Input Range**
- **Specified at 2.7V, 5V, and 10V**
- **Typical Supply Current 25  $\mu$ A at 5V**
- **50 kHz Gain-Bandwidth at 5V**
- **Similar to Popular LMC6462**
- **Output to Within 20 mV of Supply Rail at 100k Load**
- **Good Capacitive Load Drive**

## APPLICATIONS

- **Mobile Communications**
- **Portable Computing**
- **Current Sensing for Battery Chargers**
- **Voltage Reference Buffering**
- **Sensor Interface**
- **Stable Bias for GaAs RF Amps**

## DESCRIPTION

The LMC7111 is a micropower CMOS operational amplifier available in the space saving SOT-23 package. This makes the LMC7111 ideal for space and weight critical designs. The wide common-mode input range makes it easy to design battery monitoring circuits which sense signals above the  $V^+$  supply. The main benefits of the Tiny package are most apparent in small portable electronic devices, such as mobile phones, pagers, and portable computers. The tiny amplifiers can be placed on a board where they are needed, simplifying board layout.

## Connection Diagram

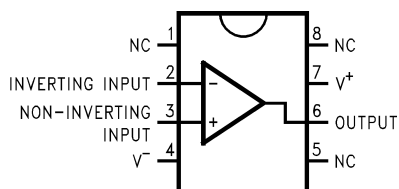

**Figure 1. 8-Pin PDIP  
Top View**

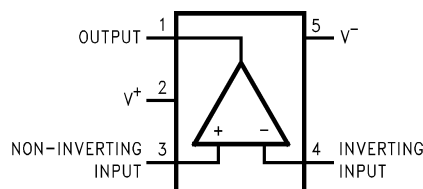

**Figure 2. 5-Pin SOT-23  
Top View**



**Figure 3. Actual Size**



Please be aware that an important notice concerning availability, standard warranty, and use in critical applications of Texas Instruments semiconductor products and disclaimers thereto appears at the end of this data sheet.

All trademarks are the property of their respective owners.



These devices have limited built-in ESD protection. The leads should be shorted together or the device placed in conductive foam during storage or handling to prevent electrostatic damage to the MOS gates.

### Absolute Maximum Ratings <sup>(1)(2)</sup>

ESD Tolerance <sup>(3)</sup>	SOT-23 Package	2000V
	PDIP Package	1500V
Differential Input Voltage		±Supply Voltage
Voltage at Input/Output Pin		(V <sup>+</sup> ) + 0.3V, (V <sup>-</sup> ) - 0.3V
Supply Voltage (V <sup>+</sup> - V <sup>-</sup> )		11V
Current at Input Pin		±5 mA
Current at Output Pin <sup>(4)</sup>		±30 mA
Current at Power Supply Pin		30 mA
Lead Temp. (Soldering, 10 sec.)		260°C
Storage Temperature Range		-65°C to +150°C
Junction Temperature <sup>(5)</sup>		150°C

- (1) Absolute Maximum Ratings indicate limits beyond which damage to the device may occur. Operating Ratings indicate conditions for which the device is intended to be functional, but specific performance is not ensured. For ensured specifications and the test conditions, see the Electrical Characteristics.
- (2) If Military/Aerospace specified devices are required, please contact the TI Sales Office/ Distributors for availability and specifications.
- (3) Human Body Model is 1.5 kΩ in series with 100 pF.
- (4) Applies to both single-supply and split-supply operation. Continuous short circuit operation at elevated ambient temperature can result in exceeding the maximum allowed junction temperature at 150°C.
- (5) The maximum power dissipation is a function of T<sub>J(MAX)</sub>, θ<sub>JA</sub> and T<sub>A</sub>. The maximum allowable power dissipation at any ambient temperature is P<sub>D</sub> = (T<sub>J(MAX)</sub> - T<sub>A</sub>)/θ<sub>JA</sub>. All numbers apply for packages soldered directly into a PC board.

### Operating Ratings <sup>(1)</sup>

Supply Voltage		2.5V ≤ V <sup>+</sup> ≤ 11V
Junction Temperature Range	LMC7111AI, LMC7111BI	-40°C ≤ T <sub>J</sub> ≤ +85°C
Thermal Resistance (θ <sub>JA</sub> )	8-Pin PDIP	115°C/W
	5-Pin SOT-23	325°C/W

- (1) Absolute Maximum Ratings indicate limits beyond which damage to the device may occur. Operating Ratings indicate conditions for which the device is intended to be functional, but specific performance is not specified. For ensured specifications and the test conditions, see the Electrical Characteristics.

### 2.7V DC Electrical Characteristics

Unless otherwise specified, all limits specified for T<sub>J</sub> = 25°C, V<sup>+</sup> = 2.7V, V<sup>-</sup> = 0V, V<sub>CM</sub> = V<sub>O</sub> = V<sup>+</sup>/2 and R<sub>L</sub> > 1 MΩ. **Boldface** limits apply at the temperature extremes.

Symbol	Parameter	Conditions	Typ <sup>(1)</sup>	LMC7111AI Limit <sup>(2)</sup>	LMC7111BI Limit <sup>(2)</sup>	Units
V <sub>OS</sub>	Input Offset Voltage	V <sup>+</sup> = 2.7V	0.9	3	7	mV
				<b>5</b>	<b>9</b>	max
TCV <sub>OS</sub>	Input Offset Voltage Average Drift		2.0			μV/°C
I <sub>B</sub>	Input Bias Current	See <sup>(3)</sup>	0.1	1	1	pA
				<b>20</b>	<b>20</b>	max
I <sub>OS</sub>	Input Offset Current	See <sup>(3)</sup>	0.01	0.5	0.5	pA
				<b>10</b>	<b>10</b>	max
R <sub>IN</sub>	Input Resistance		>10			Tera Ω
+PSRR	Positive Power Supply Rejection Ratio	2.7V ≤ V <sup>+</sup> ≤ 5.0V, V <sup>-</sup> = 0V, V <sub>O</sub> = 2.5V	60	55 <b>50</b>	55 <b>50</b>	dB min
-PSRR	Negative Power Supply Rejection Ratio	-2.7V ≤ V <sup>-</sup> ≤ -5.0V, V <sup>+</sup> = 0V, V <sub>O</sub> = 2.5V	60	55 <b>50</b>	55 <b>50</b>	dB min

- (1) Typical Values represent the most likely parametric norm.
- (2) All limits are specified by testing or statistical analysis.
- (3) Bias Current specified by design and processing.

## 2.7V DC Electrical Characteristics (continued)

Unless otherwise specified, all limits specified for  $T_J = 25^\circ\text{C}$ ,  $V^+ = 2.7\text{V}$ ,  $V^- = 0\text{V}$ ,  $V_{\text{CM}} = V_O = V^+/2$  and  $R_L > 1\text{ M}\Omega$ . **Boldface** limits apply at the temperature extremes.

Symbol	Parameter	Conditions	Typ <sup>(1)</sup>	LMC7111AI Limit <sup>(2)</sup>	LMC7111BI Limit <sup>(2)</sup>	Units
$V_{\text{CM}}$	Input Common-Mode Voltage Range	$V^+ = 2.7\text{V}$ For CMRR $\geq 50\text{ dB}$	-0.10	0.0 <b>0.40</b>	0.0 <b>0.40</b>	V min
			2.8	2.7 <b>2.25</b>	2.7 <b>2.25</b>	V max
$C_{\text{IN}}$	Common-Mode Input Capacitance		3			pF
$V_O$	Output Swing	$V^+ = 2.7\text{V}$ $R_L = 100\text{ k}\Omega$	2.69	2.68 <b>2.4</b>	2.68 <b>2.4</b>	V min
			0.01	0.02 <b>0.08</b>	0.02 <b>0.08</b>	V max
		$V^+ = 2.7\text{V}$ $R_L = 10\text{ k}\Omega$	2.65	2.6 <b>2.4</b>	2.6 <b>2.4</b>	V min
			0.03	0.1 <b>0.3</b>	0.1 <b>0.3</b>	V max
$I_{\text{SC}}$	Output Short Circuit Current	Sourcing, $V_O = 0\text{V}$	7	1 <b>0.7</b>	1 <b>0.7</b>	mA min
		Sinking, $V_O = 2.7\text{V}$	7	1 <b>0.7</b>	1 <b>0.7</b>	mA min
$A_{\text{VOL}}$	Voltage Gain	Sourcing	400			V/mv min
		Sinking	150			V/mv min
$I_S$	Supply Current	$V^+ = +2.7\text{V}$ , $V_O = V^+/2$	20	45 <b>60</b>	50 <b>65</b>	$\mu\text{A}$ max

## 2.7V AC Electrical Characteristics

Unless otherwise specified, all limits specified for  $T_J = 25^\circ\text{C}$ ,  $V^+ = 2.7\text{V}$ ,  $V^- = 0\text{V}$ ,  $V_{\text{CM}} = V_O = V^+/2$  and  $R_L > 1\text{ M}\Omega$ . **Boldface** limits apply at the temperature extremes.

Symbol	Parameter	Conditions	Typ <sup>(1)</sup>	LMC7111AI Limit <sup>(2)</sup>	LMC7111BI Limit <sup>(2)</sup>	Units
SR	Slew Rate	See <sup>(3)</sup>	0.015			V/ $\mu\text{s}$
GBW	Gain-Bandwidth Product		40			kHz

(1) Typical Values represent the most likely parametric norm.

(2) All limits are specified by testing or statistical analysis.

(3) Connected as Voltage Follower with 1.0V step input. Number specified is the slower of the positive and negative slew rates. Input referred,  $V^+ = 2.7\text{V}$  and  $R_L = 100\text{ k}\Omega$  connected to 1.35V. Amp excited with 1 kHz to produce  $V_O = 1\text{ V}_{\text{PP}}$ .

## 3V DC Electrical Characteristics

Unless otherwise specified, all limits specified for  $T_J = 25^\circ\text{C}$ ,  $V^+ = 3\text{V}$ ,  $V^- = 0\text{V}$ ,  $V_{\text{CM}} = V_O = V^+/2$  and  $R_L > 1\text{ M}\Omega$ . **Boldface** limits apply at the temperature extremes.

Symbol	Parameter	Conditions	Typ <sup>(1)</sup>	LMC7111AI Limit <sup>(2)</sup>	LMC7111BI Limit <sup>(2)</sup>	Units
$V_{\text{CM}}$	Input Common-Mode Voltage Range	$V^+ = 3\text{V}$ For CMRR $\geq 50\text{ dB}$	-0.25	0.0	0.0	V min
			3.2	3.0 <b>2.8</b>	3.0 <b>2.8</b>	V max

(1) Typical Values represent the most likely parametric norm.

(2) All limits are specified by testing or statistical analysis.

### 3.3V DC Electrical Characteristics

Unless otherwise specified, all limits specified for  $T_J = 25^\circ\text{C}$ ,  $V^+ = 3.3\text{V}$ ,  $V^- = 0\text{V}$ ,  $V_{\text{CM}} = V_O = V^+/2$  and  $R_L > 1\text{ M}\Omega$ . **Boldface** limits apply at the temperature extremes.

Symbol	Parameter	Conditions	Typ <sup>(1)</sup>	LMC7111AI Limit <sup>(2)</sup>	LMC7111BI Limit <sup>(2)</sup>	Units
$V_{\text{CM}}$	Input Common-Mode Voltage Range	$V^+ = 3.3\text{V}$ For CMRR $\geq 50\text{ dB}$	-0.25	-0.1 <b>0.00</b>	-0.1 <b>0.00</b>	V min
			3.5	3.4 <b>3.2</b>	3.4 <b>3.2</b>	V max

(1) Typical Values represent the most likely parametric norm.

(2) All limits are specified by testing or statistical analysis.

### 5V DC Electrical Characteristics

Unless otherwise specified, all limits specified for  $T_J = 25^\circ\text{C}$ ,  $V^+ = 5\text{V}$ ,  $V^- = 0\text{V}$ ,  $V_{\text{CM}} = V_O = V^+/2$  and  $R_L > 1\text{ M}\Omega$ . **Boldface** limits apply at the temperature extremes.

Symbol	Parameter	Conditions	Typ <sup>(1)</sup>	LMC7111AI Limit <sup>(2)</sup>	LMC7111BI Limit <sup>(2)</sup>	Units
$V_{\text{OS}}$	Input Offset Voltage	$V^+ = 5\text{V}$	0.9			mV max
$\text{TCV}_{\text{OS}}$	Input Offset Voltage Average Drift		2.0			$\mu\text{V}/^\circ\text{C}$
$I_B$	Input Bias Current	See <sup>(3)</sup>	0.1	1 <b>20</b>	1 <b>20</b>	pA max
$I_{\text{OS}}$	Input Offset Current	See <sup>(3)</sup>	0.01	0.5 <b>10</b>	0.5 <b>10</b>	pA max
$R_{\text{IN}}$	Input Resistance		>10			Tera $\Omega$
CMRR	Common Mode Rejection Ratio	$0\text{V} \leq V_{\text{CM}} \leq 5\text{V}$	85	70	60	dB min
+PSRR	Positive Power Supply Rejection Ratio	$5\text{V} \leq V^+ \leq 10\text{V}$ , $V^- = 0\text{V}$ , $V_O = 2.5\text{V}$	85	70	60	dB min
-PSRR	Negative Power Supply Rejection Ratio	$-5\text{V} \leq V^- \leq -10\text{V}$ , $V^+ = 0\text{V}$ , $V_O = -2.5\text{V}$	85	70	60	dB min
$V_{\text{CM}}$	Input Common-Mode Voltage Range	$V^+ = 5\text{V}$ For CMRR $\geq 50\text{ dB}$	-0.3	-0.20 <b>0.00</b>	-0.20 <b>0.00</b>	V min
			5.25	5.20 <b>5.00</b>	5.20 <b>5.00</b>	V max
$C_{\text{IN}}$	Common-Mode Input Capacitance		3			pF
$V_O$	Output Swing	$V^+ = 5\text{V}$ $R_L = 100\text{ k}\Omega$	4.99	4.98	4.98	Vmin
			0.01	0.02	0.02	Vmax
		$V^+ = 5\text{V}$ $R_L = 10\text{ k}\Omega$	4.98	4.9	4.9	Vmin
			0.02	0.1	0.1	Vmin
$I_{\text{SC}}$	Output Short Circuit Current	Sourcing, $V_O = 0\text{V}$	7	5 <b>3.5</b>	5 <b>3.5</b>	mA min
		Sinking, $V_O = 3\text{V}$	7	5 <b>3.5</b>	5 <b>3.5</b>	mA min
$A_{\text{VOL}}$	Voltage Gain	Sourcing	500			V/mv min
		Sinking	200			V/mv min
$I_S$	Supply Current	$V^+ = +5\text{V}$ , $V_O = V^+/2$	25			$\mu\text{A}$ max

(1) Typical Values represent the most likely parametric norm.

(2) All limits are specified by testing or statistical analysis.

(3) Bias Current specified by design and processing.

## 5V AC Electrical Characteristics

Unless otherwise specified, all limits specified for  $T_J = 25^\circ\text{C}$ ,  $V^+ = 5\text{V}$ ,  $V^- = 0\text{V}$ ,  $V_{\text{CM}} = V_O = V^+/2$  and  $R_L > 1\text{M}\Omega$ . **Boldface** limits apply at the temperature extremes.

Symbol	Parameter	Conditions	Typ <sup>(1)</sup>	LMC7111AI Limit <sup>(2)</sup>	LMC7111BI Limit <sup>(2)</sup>	Units
SR	Slew Rate	Positive Going Slew Rate <sup>(3)</sup>	0.027	0.015	0.010	V/ $\mu\text{s}$
GBW	Gain-Bandwidth Product		50			kHz

(1) Typical Values represent the most likely parametric norm.

(2) All limits are specified by testing or statistical analysis.

(3) Connected as Voltage Follower with 1.0V step input. Number specified is the slower of the positive slew rate. The negative slew rate is faster. Input referred,  $V^+ = 5\text{V}$  and  $R_L = 100\text{ k}\Omega$  connected to 1.5V. Amp excited with 1 kHz to produce  $V_O = 1\text{ V}_{\text{PP}}$ .

## 10V DC Electrical Characteristics

Unless otherwise specified, all limits specified for  $T_J = 25^\circ\text{C}$ ,  $V^+ = 10\text{V}$ ,  $V^- = 0\text{V}$ ,  $V_{\text{CM}} = V_O = V^+/2$  and  $R_L > 1\text{M}\Omega$ . **Boldface** limits apply at the temperature extremes.

Symbol	Parameter	Conditions	Typ <sup>(1)</sup>	LMC7111AI Limit <sup>(2)</sup>	LMC7111BI Limit <sup>(2)</sup>	Units
$V_{\text{OS}}$	Input Offset Voltage	$V^+ = 10\text{V}$	0.9	<b>3</b> <b>5</b>	<b>7</b> <b>9</b>	mV max
$\text{TCV}_{\text{OS}}$	Input Offset Voltage Average Drift		2.0			$\mu\text{V}/^\circ\text{C}$
$I_B$	Input Bias Current		0.1	<b>1</b> <b>20</b>	<b>1</b> <b>20</b>	pA max
$I_{\text{OS}}$	Input Offset Current		0.01	<b>0.5</b> <b>10</b>	<b>0.5</b> <b>10</b>	pA max
$R_{\text{IN}}$	Input Resistance		>10			Tera $\Omega$
+PSRR	Positive Power Supply Rejection Ratio	$5\text{V} \leq V^+ \leq 10\text{V}$ , $V^- = 0\text{V}$ , $V_O = 2.5\text{V}$	80			dB min
-PSRR	Negative Power Supply Rejection Ratio	$-5\text{V} \leq V^- \leq -10\text{V}$ , $V^+ = 0\text{V}$ , $V_O = 2.5\text{V}$	80			dB min
$V_{\text{CM}}$	Input Common-Mode Voltage Range	$V^+ = 10\text{V}$ For $\text{CMRR} \geq 50\text{ dB}$	-0.2	-0.15 <b>0.00</b>	-0.15 <b>0.00</b>	V min
			10.2	10.15 <b>10.00</b>	10.15 <b>10.00</b>	V max
$C_{\text{IN}}$	Common-Mode Input Capacitance		3			pF
$I_{\text{SC}}$	Output Short Circuit Current <sup>(3)</sup>	Sourcing, $V_O = 0\text{V}$	30	<b>20</b> <b>7</b>	<b>20</b> <b>7</b>	mA min
		Sinking, $V_O = 10\text{V}$	30	<b>20</b> <b>7</b>	<b>20</b> <b>7</b>	mA min
$A_{\text{VOL}}$	Voltage Gain 100 k $\Omega$ Load	Sourcing	500			V/mv min
		Sinking	200			V/mv min
$I_S$	Supply Current	$V^+ = +10\text{V}$ , $V_O = V^+/2$	25	50 <b>65</b>	60 <b>75</b>	$\mu\text{A}$ max
$V_O$	Output Swing	$V^+ = 10\text{V}$ $R_L = 100\text{ k}\Omega$	9.99	9.98	9.98	Vmin
			0.01	0.02	0.02	Vmax
		$V^+ = 10\text{V}$ $R_L = 10\text{ k}\Omega$	9.98	9.9	9.9	Vmin
			0.02	0.1	0.1	Vmin

(1) Typical Values represent the most likely parametric norm.

(2) All limits are specified by testing or statistical analysis.

(3) Bias Current specified by design and processing.

## 10V AC Electrical Characteristics

Unless otherwise specified, all limits specified for  $T_j = 25^\circ\text{C}$ ,  $V^+ = 10\text{V}$ ,  $V^- = 0\text{V}$ ,  $V_{\text{CM}} = V_O = V^+/2$  and  $R_L > 1\text{M}\Omega$ . **Boldface** limits apply at the temperature extremes.

Symbol	Parameter	Conditions	Typ <sup>(1)</sup>	LMC7111AI Limit <sup>(2)</sup>	LMC7111BI Limit <sup>(2)</sup>	Units
SR	Slew Rate	See <sup>(3)</sup>	0.03			V/ $\mu\text{s}$
GBW	Gain-Bandwidth Product		50			kHz
$\phi_m$	Phase Margin		50			deg
$G_m$	Gain Margin		15			dB
	Input-Referred Voltage Noise	$f = 1\text{kHz}$ $V_{\text{CM}} = 1\text{V}$	110			nV/ $\sqrt{\text{Hz}}$
	Input-Referred Current Noise	$f = 1\text{kHz}$	0.03			pA/ $\sqrt{\text{Hz}}$

(1) Typical Values represent the most likely parametric norm.

(2) All limits are specified by testing or statistical analysis.

(3) Connected as Voltage Follower with 1.0V step input. Number specified is the slower of the positive and negative slew rates. Input referred,  $V^+ = 10\text{V}$  and  $R_L = 100\text{k}\Omega$  connected to 5V. Amp excited with 1 kHz to produce  $V_O = 2 V_{\text{PP}}$ .

### Typical Performance Characteristics

$T_A = 25^\circ\text{C}$  unless specified, Single Supply

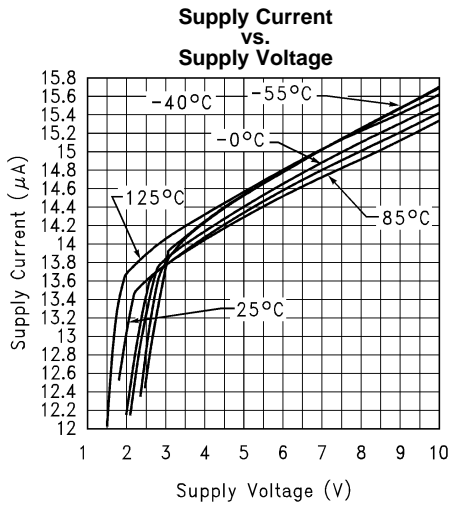

Figure 4.

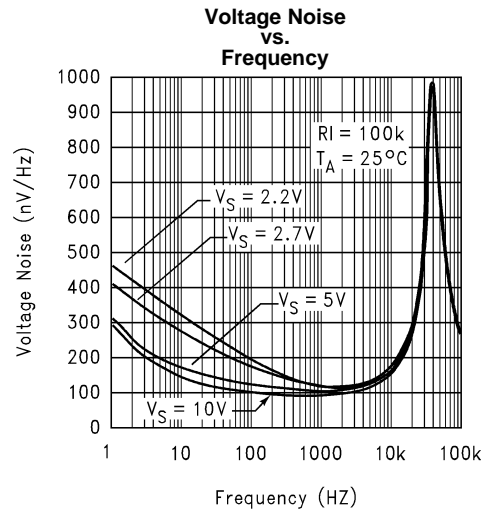

Figure 5.

### 2.7V Performance

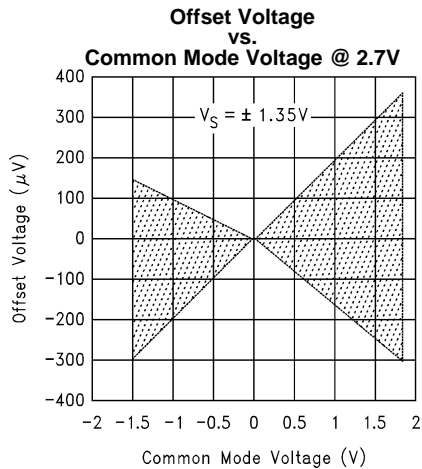

Figure 6.

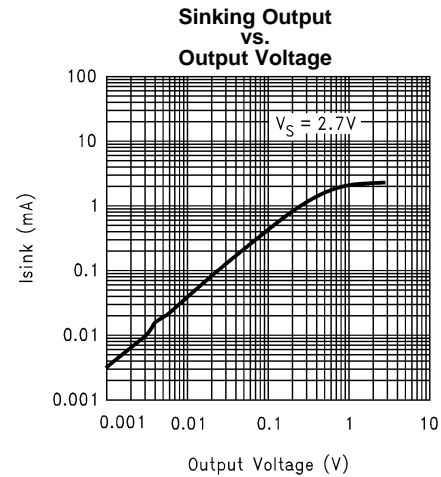

Figure 7.

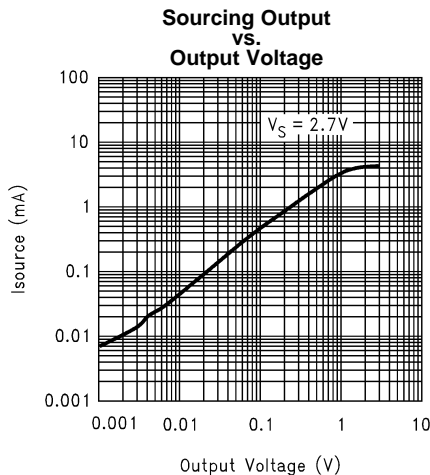

Figure 8.

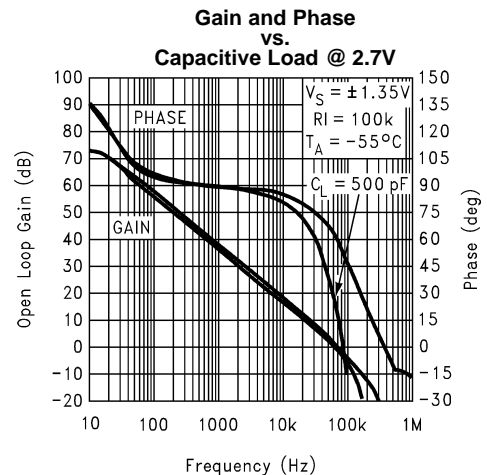

Figure 9.

2.7V Performance (continued)

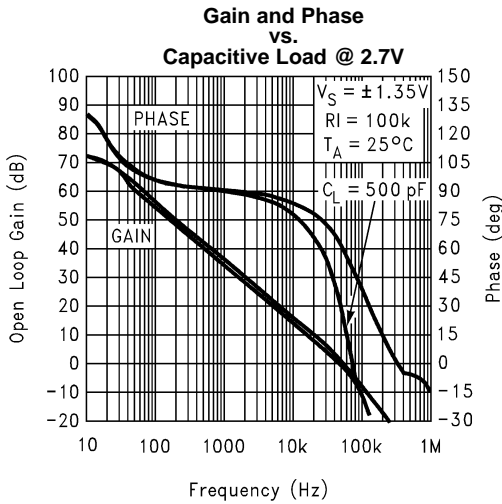

Figure 10.

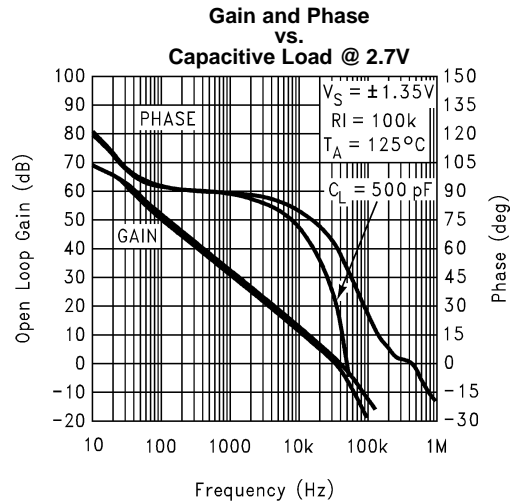

Figure 11.

3V Performance

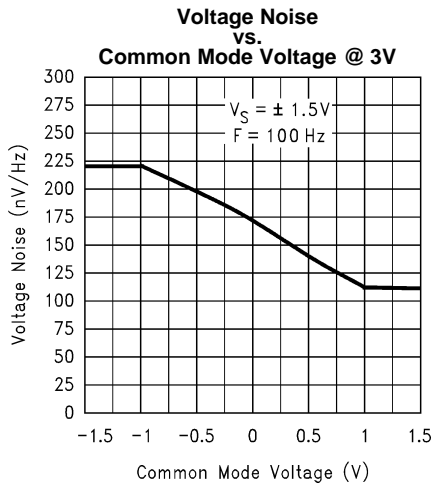

Figure 12.

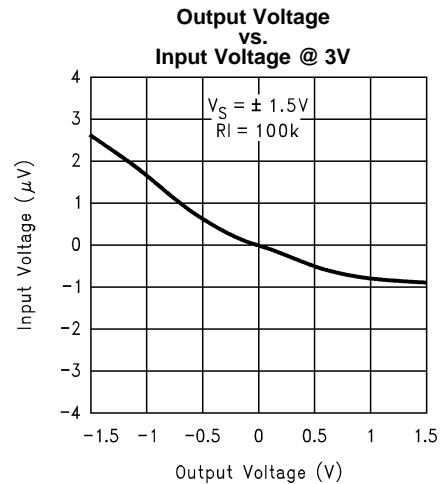

Figure 13.

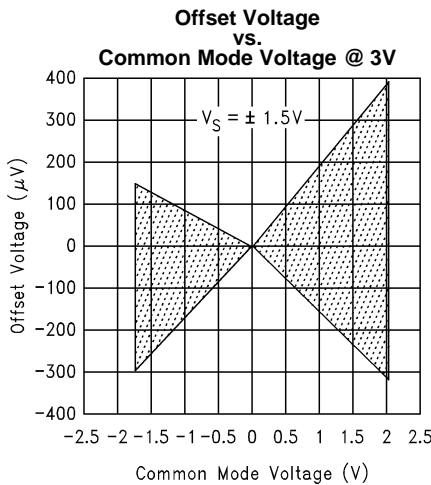

Figure 14.

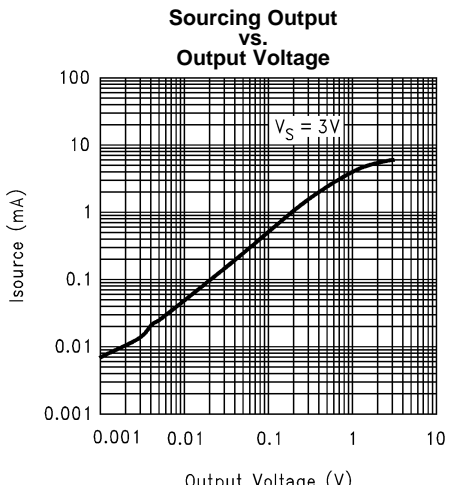

Figure 15.



### 3V Performance (continued)

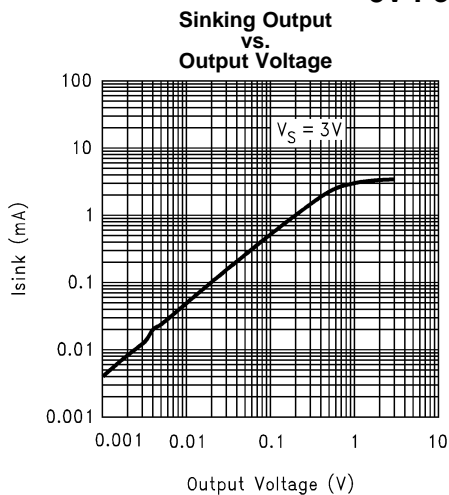

Figure 16.

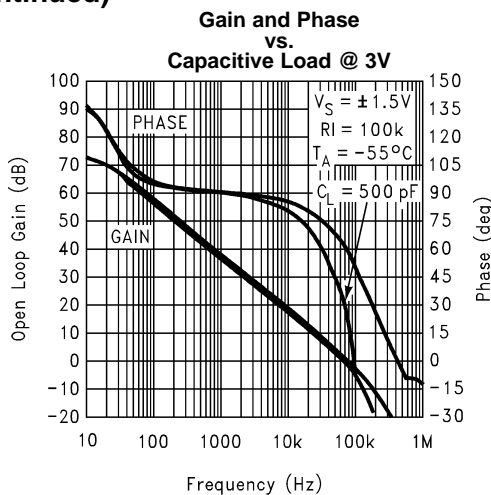

Figure 17.

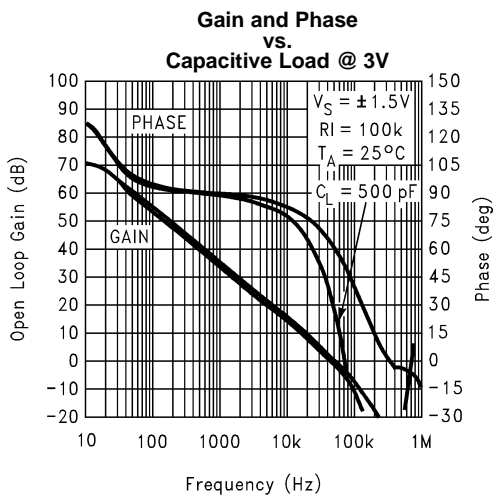

Figure 18.

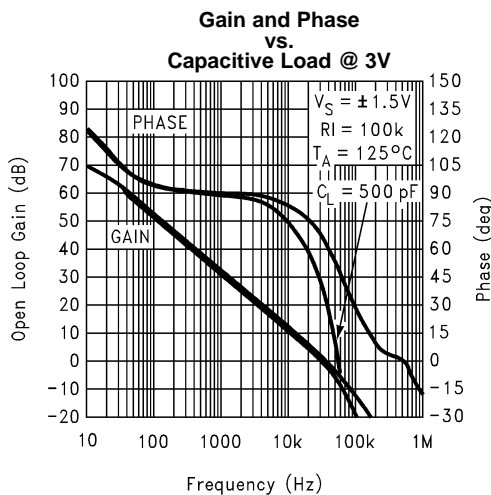

Figure 19.

### 5V Performance

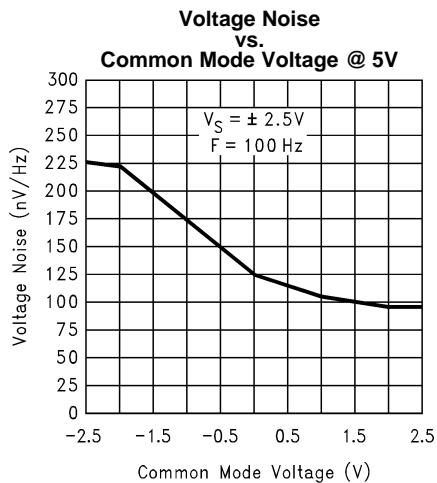

Figure 20.

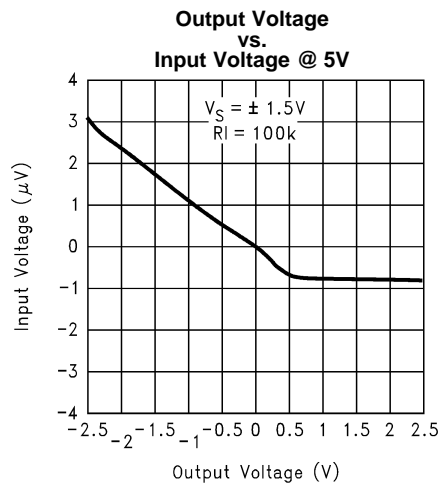
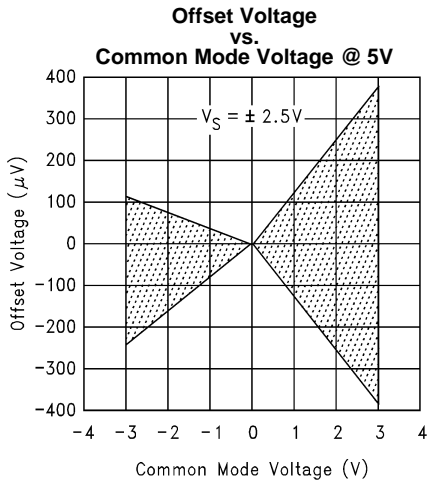
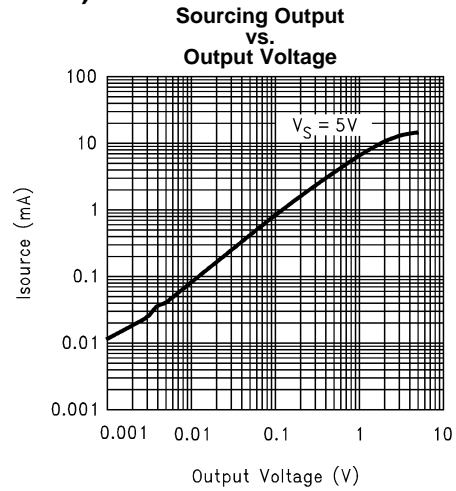

Figure 21.

**5V Performance (continued)**



**Figure 22.**



**Figure 23.**

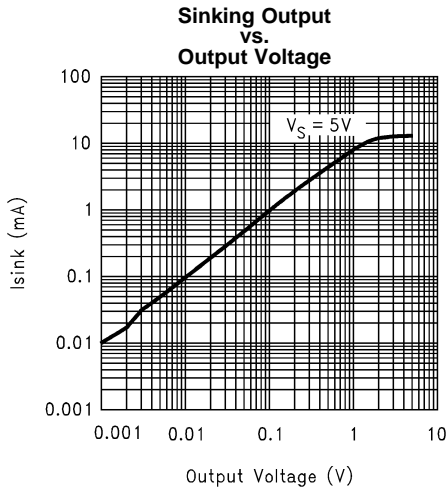

**Figure 24.**

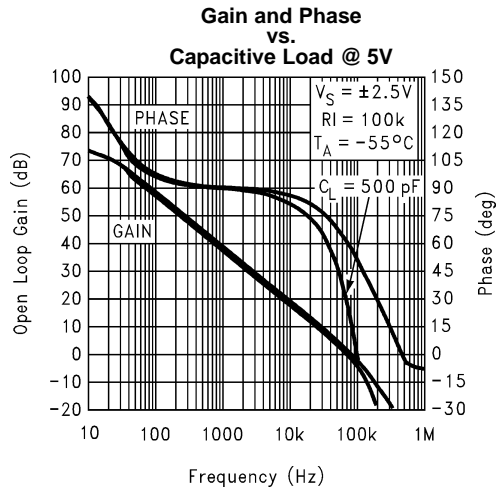

**Figure 25.**

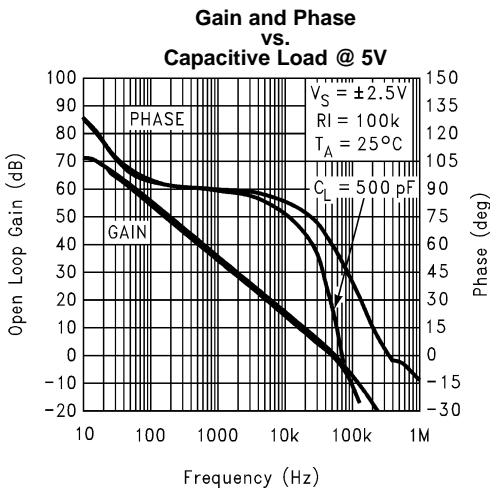

**Figure 26.**

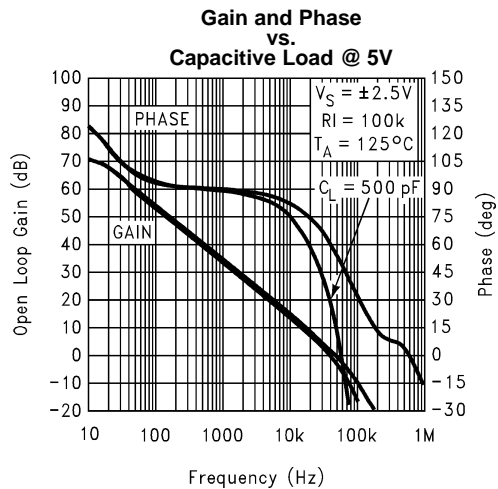

**Figure 27.**

5V Performance (continued)

Non-Inverting  
Small Signal Pulse Response  
at 5V

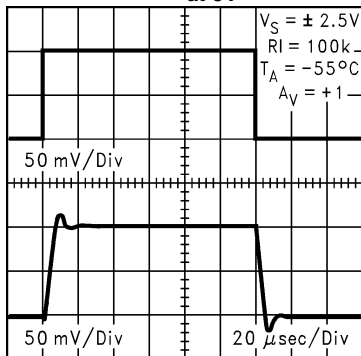

Figure 28.

Non-Inverting  
Small Signal Pulse Response  
at 5V

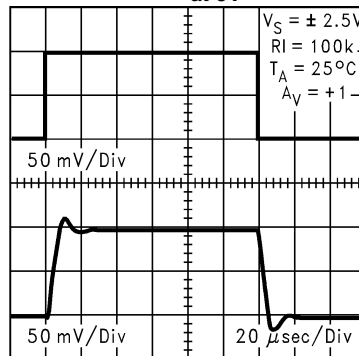

Figure 29.

Non-Inverting  
Small Signal Pulse Response  
at 5V

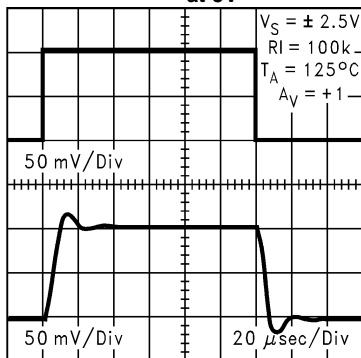

Figure 30.

Non-Inverting  
Large Signal Pulse Response  
at 5V

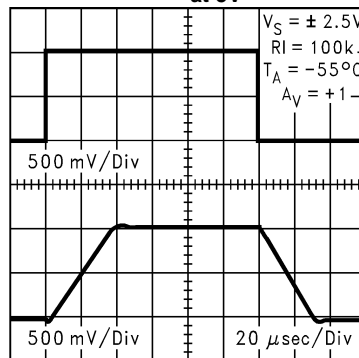

Figure 31.

Non-Inverting  
Large Signal Pulse Response  
at 5V

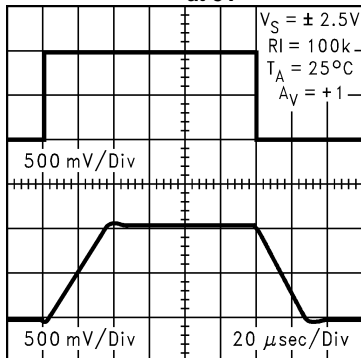

Figure 32.

Non-Inverting  
Large Signal Pulse Response  
at 5V

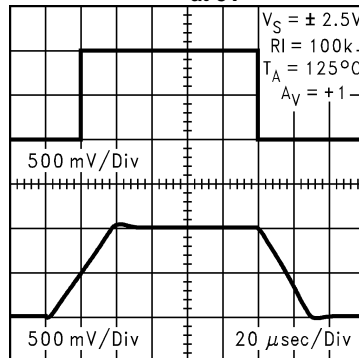

Figure 33.

5V Performance (continued)

**Inverting Small Signal Pulse Response at 5V**

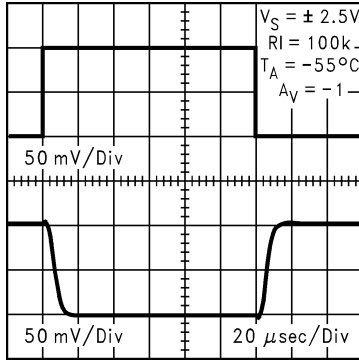

Figure 34.

**Inverting Small Signal Pulse Response at 5V**

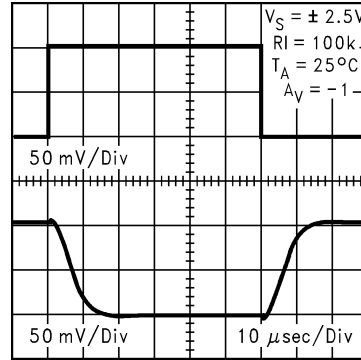

Figure 35.

**Inverting Small Signal Pulse Response at 5V**

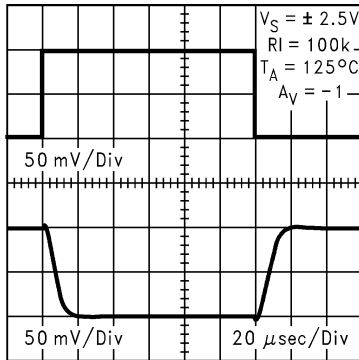

Figure 36.

**Inverting Large Signal Pulse Response at 5V**

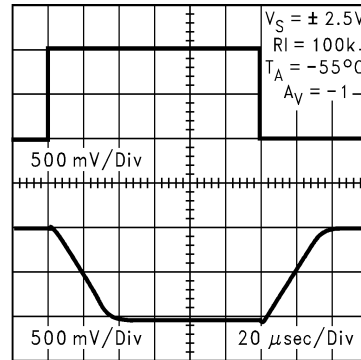

Figure 37.

**Inverting Large Signal Pulse Response at 5V**

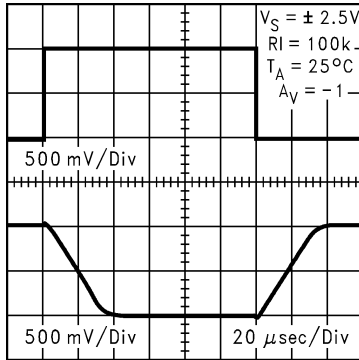

Figure 38.

**Inverting Large Signal Pulse Response at 5V**

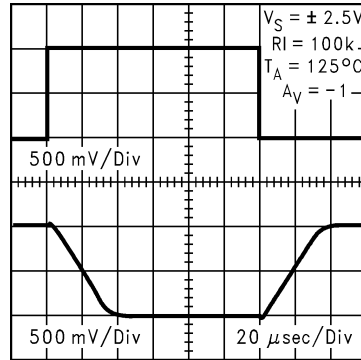

Figure 39.

### 10V Performance

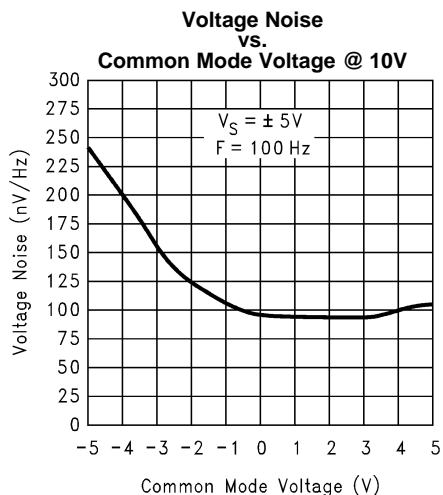

Figure 40.

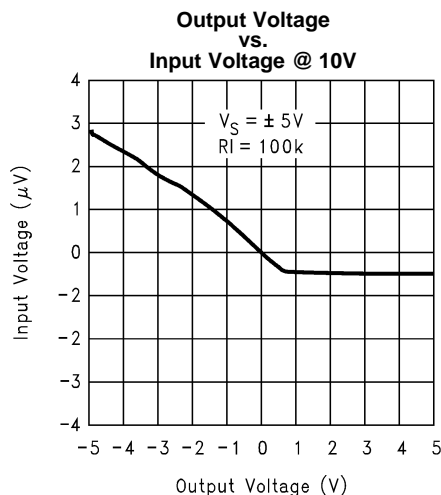

Figure 41.

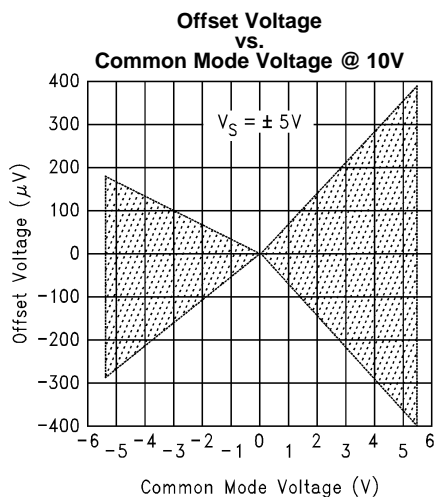

Figure 42.

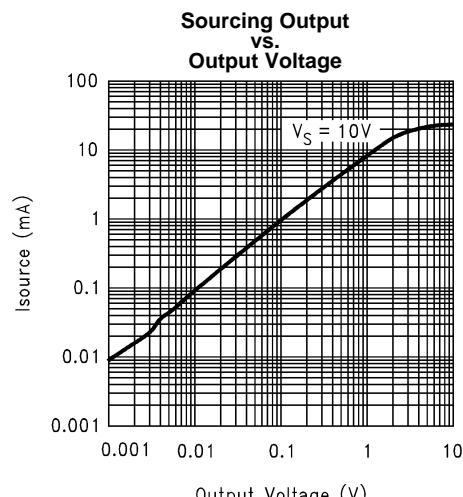

Figure 43.

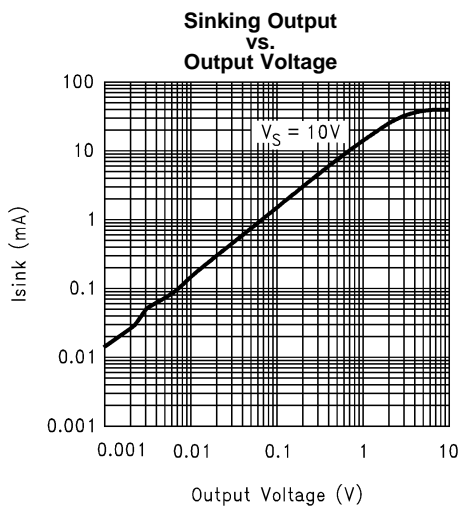

Figure 44.

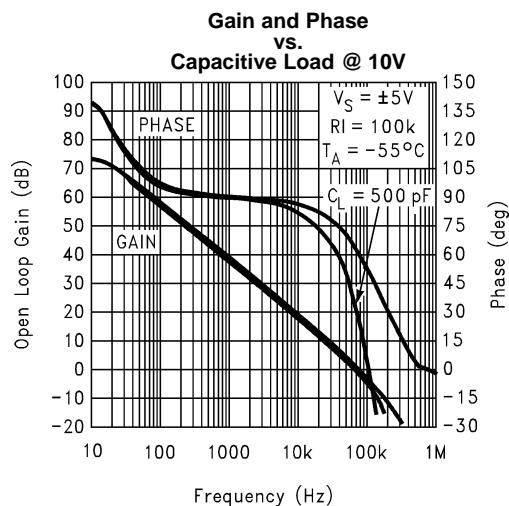

Figure 45.

10V Performance (continued)

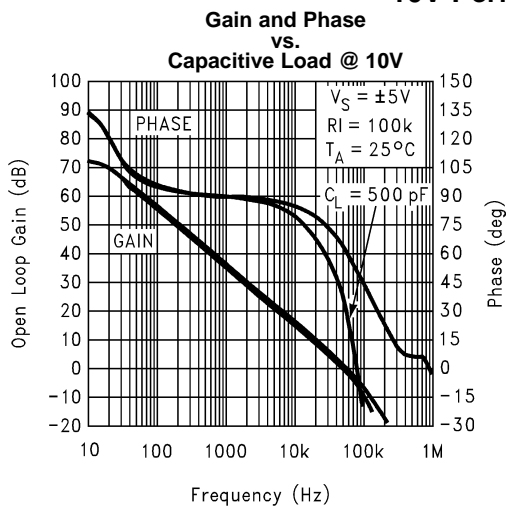

Figure 46.

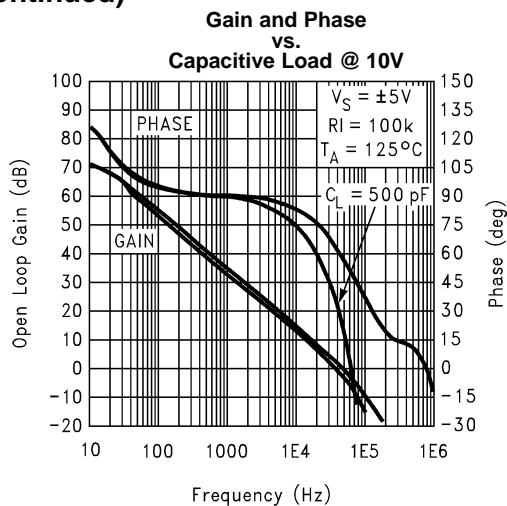

Figure 47.

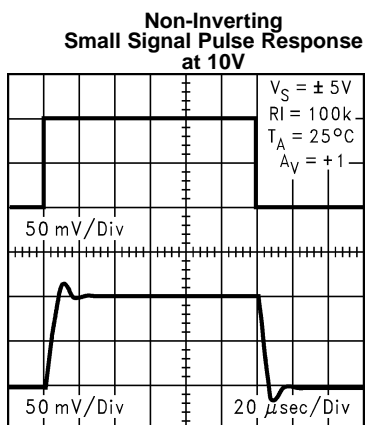

Figure 48.

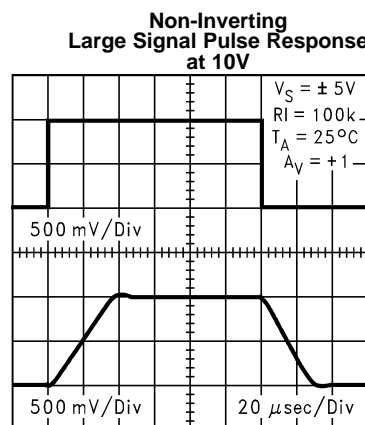

Figure 49.

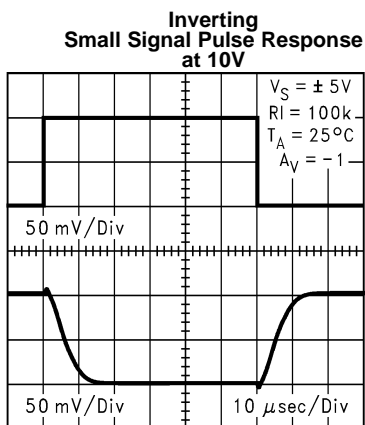

Figure 50.

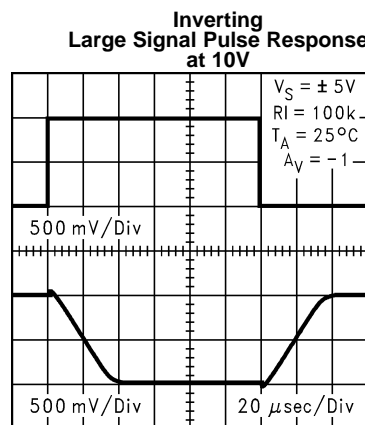

Figure 51.

## APPLICATION INFORMATION

### BENEFITS OF THE LMC7111 TINY AMP

#### Size

The small footprint of the SOT-23 packaged Tiny amp, (0.120 x 0.118 inches, 3.05 x 3.00 mm) saves space on printed circuit boards, and enable the design of smaller electronic products. Because they are easier to carry, many customers prefer smaller and lighter products.

#### Height

The height (0.056 inches, 1.43 mm) of the Tiny amp makes it possible to use it in PCMCIA type III cards.

#### Signal Integrity

Signals can pick up noise between the signal source and the amplifier. By using a physically smaller amplifier package, the Tiny amp can be placed closer to the signal source, reducing noise pickup and increasing signal integrity. The Tiny amp can also be placed next to the signal destination, such as a buffer for the reference of an analog to digital converter.

#### Simplified Board Layout

The Tiny amp can simplify board layout in several ways. First, by placing an amp where amps are needed, instead of routing signals to a dual or quad device, long pc traces may be avoided.

By using multiple Tiny amps instead of duals or quads, complex signal routing and possibly crosstalk can be reduced.

#### DIPs available for prototyping

LMC7111 amplifiers packaged in conventional 8-pin dip packages can be used for prototyping and evaluation without the need to use surface mounting in early project stages.

#### Low Supply Current

The typical 25  $\mu$ A supply current of the LMC7111 extends battery life in portable applications, and may allow the reduction of the size of batteries in some applications.

#### Wide Voltage Range

The LMC7111 is characterized at 2.7V, 3V, 3.3V, 5V and 10V. Performance data is provided at these popular voltages. This wide voltage range makes the LMC7111 a good choice for devices where the voltage may vary over the life of the batteries.

### INPUT COMMON MODE VOLTAGE RANGE

The LMC7111 does not exhibit phase inversion when an input voltage exceeds the negative supply voltage.

The absolute maximum input voltage is 300 mV beyond either rail at room temperature. Voltages greatly exceeding this maximum rating can cause excessive current to flow in or out of the input pins, adversely affecting reliability.

Applications that exceed this rating must externally limit the maximum input current to  $\pm 5$  mA with an input resistor as shown in [Figure 52](#).

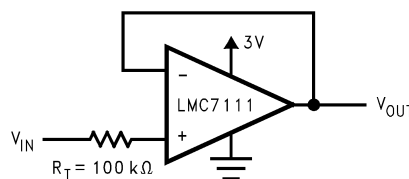
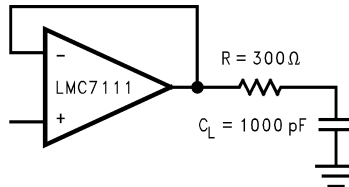

**Figure 52.  $R_I$  Input Current Protection for Voltages Exceeding the Supply Voltage**

## CAPACITIVE LOAD TOLERANCE

The LMC7111 can typically directly drive a 300 pF load with  $V_S = 10V$  at unity gain without oscillating. The unity gain follower is the most sensitive configuration. Direct capacitive loading reduces the phase margin of op-amps. The combination of the op-amp's output impedance and the capacitive load induces phase lag. This results in either an underdamped pulse response or oscillation.

Capacitive load compensation can be accomplished using resistive isolation as shown in [Figure 53](#). This simple technique is useful for isolating the capacitive input of multiplexers and A/D converters.



**Figure 53. Resistive Isolation of a 300 pF Capacitive Load**

## COMPENSATING FOR INPUT CAPACITANCE WHEN USING LARGE VALUE FEEDBACK RESISTORS

When using very large value feedback resistors, (usually  $> 500 \text{ k}\Omega$ ) the large feedback resistance can react with the input capacitance due to transducers, photodiodes, and circuit board parasitics to reduce phase margins.

The effect of input capacitance can be compensated for by adding a feedback capacitor. The feedback capacitor (as in [Figure 54](#)),  $C_f$  is first estimated by:

$$\frac{1}{2\pi R_1 C_{IN}} \geq \frac{1}{2\pi R_2 C_f} \quad (1)$$

or

$$R_1 C_{IN} \leq R_2 C_f \quad (2)$$

which typically provides significant overcompensation.

Printed circuit board stray capacitance may be larger or smaller than that of a breadboard, so the actual optimum value for  $C_f$  may be different. The values of  $C_f$  should be checked on the actual circuit. (Refer to the LMC660 quad CMOS amplifier data sheet for a more detailed discussion.)

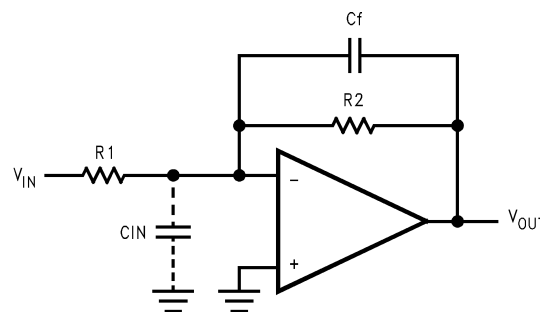

**Figure 54. Cancelling the Effect of Input Capacitance**

## OUTPUT SWING

The output of the LMC7111 will go to within 100 mV of either power supply rail for a 10 kΩ load and to 20 mV of the rail for a 100 kΩ load. This makes the LMC7111 useful for driving transistors which are connected to the same power supply. By going very close to the supply, the LMC7111 can turn the transistors all the way on or all the way off.



## BIASING GaAs RF AMPLIFIERS

The capacitive load capability, low current draw, and small size of the SOT-23 LMC7111 make it a good choice for providing a stable negative bias to other integrated circuits.

The very small size of the LMC7111 and the LM4040 reference take up very little board space.

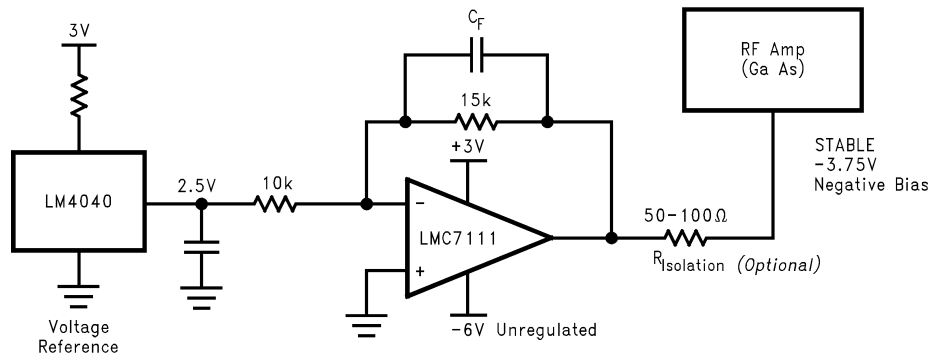

$C_F$  and  $R_{Isolation}$  prevent oscillations when driving capacitive loads.

Figure 55. Stable Negative Bias

## REFERENCE BUFFER FOR A-TO-D CONVERTERS

The LMC7111 can be used as a voltage reference buffer for analog-to-digital converters. This works best for A-to-D converters whose reference input is a static load, such as dual slope integrating A-to-Ds. Converters whose reference input is a dynamic load (the reference current changes with time) may need a faster device, such as the LMC7101 or the LMC7131.

The small size of the LMC7111 allows it to be placed close to the reference input. The low supply current (25  $\mu$ A typical) saves power.

For A-to-D reference inputs which require higher accuracy and lower offset voltage, please see the LMC6462 datasheet. The LMC6462 has performance similar to the LMC7111. The LMC6462 is available in two grades with reduced input voltage offset.

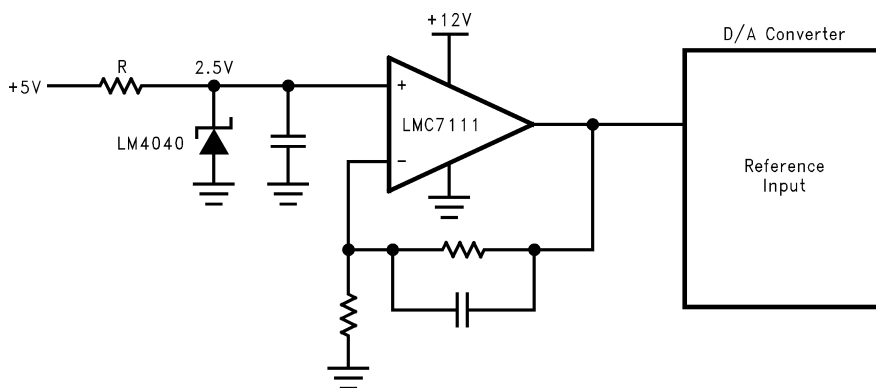

## DUAL AND QUAD DEVICES WITH SIMILAR PERFORMANCE

The LMC6462 and LMC6464 are dual and quad devices with performance similar to the LMC7111. They are available in both conventional through-hole and surface mount packaging. Please see the LMC6462/4 datasheet for details.

## SPICE MACROMODEL

A SPICE macromodel is available for the LMC7111. This model includes simulation of:

- Input common-mode voltage range
- Frequency and transient response

- Quiescent and dynamic supply current
- Output swing dependence on loading conditions and many more characteristics as listed on the macro model disk. Visit the LMC7111 product page on <http://www.ti.com> for the spice model.

### ADDITIONAL SOT-23 TINY DEVICES

Additional parts are available in the space saving SOT-23 Tiny package, including amplifiers, voltage references, and voltage regulators. These devices include—

**LMC7101** 1 MHz gain-bandwidth rail-to-rail input and output amplifier—high input impedance and high gain, 700  $\mu$ A typical current 2.7V, 3V, 5V and 15V specifications.

**LM7131** Tiny Video amp with 70 MHz gain bandwidth. Specified at 3V, 5V and  $\pm$  5V supplies.

**LMC7211** Comparator in a tiny package with rail-to-rail input and push-pull output. Typical supply current of 7  $\mu$ A. Typical propagation delay of 7  $\mu$ s. Specified at 2.7V, 5V and 15V supplies.

**LMC7221** Comparator with an open drain output for use in mixed voltage systems. Similar to the LMC7211, except the output can be used with a pull-up resistor to a voltage different than the supply voltage.

**LP2980** Micropower SOT 50 mA Ultra Low-Dropout Regulator.

**LM4040** Precision micropower shunt voltage reference. Fixed voltages of 2.5000V, 4.096V, 5.000V, 8.192V and 10.000V.

**LM4041** Precision micropower shunt voltage reference 1.225V and adjustable.

Visit <http://www.ti.com> for more information.

---

**REVISION HISTORY**

<b>Changes from Revision D (March 2013) to Revision E</b>	<b>Page</b>
<hr/> <ul style="list-style-type: none"><li>• Changed layout of National Data Sheet to TI format .....</li></ul>	<hr/> <b>18</b>

**PACKAGING INFORMATION**

Orderable Device	Status (1)	Package Type	Package Drawing	Pins	Package Qty	Eco Plan (2)	Lead/Ball Finish (6)	MSL Peak Temp (3)	Op Temp (°C)	Device Marking (4/5)	Samples
LMC7111BIM5	NRND	SOT-23	DBV	5	1000	TBD	Call TI	Call TI	-40 to 85	A01B	
LMC7111BIM5/NOPB	ACTIVE	SOT-23	DBV	5	1000	Green (RoHS & no Sb/Br)	CU SN	Level-1-260C-UNLIM	-40 to 85	A01B	<b>Samples</b>
LMC7111BIM5X	NRND	SOT-23	DBV	5	3000	TBD	Call TI	Call TI	-40 to 85	A01B	
LMC7111BIM5X/NOPB	ACTIVE	SOT-23	DBV	5	3000	Green (RoHS & no Sb/Br)	CU SN	Level-1-260C-UNLIM	-40 to 85	A01B	<b>Samples</b>

(1) The marketing status values are defined as follows:

**ACTIVE:** Product device recommended for new designs.

**LIFEBUY:** TI has announced that the device will be discontinued, and a lifetime-buy period is in effect.

**NRND:** Not recommended for new designs. Device is in production to support existing customers, but TI does not recommend using this part in a new design.

**PREVIEW:** Device has been announced but is not in production. Samples may or may not be available.

**OBSELETE:** TI has discontinued the production of the device.

(2) Eco Plan - The planned eco-friendly classification: Pb-Free (RoHS), Pb-Free (RoHS Exempt), or Green (RoHS & no Sb/Br) - please check <http://www.ti.com/productcontent> for the latest availability information and additional product content details.

**TBD:** The Pb-Free/Green conversion plan has not been defined.

**Pb-Free (RoHS):** TI's terms "Lead-Free" or "Pb-Free" mean semiconductor products that are compatible with the current RoHS requirements for all 6 substances, including the requirement that lead not exceed 0.1% by weight in homogeneous materials. Where designed to be soldered at high temperatures, TI Pb-Free products are suitable for use in specified lead-free processes.

**Pb-Free (RoHS Exempt):** This component has a RoHS exemption for either 1) lead-based flip-chip solder bumps used between the die and package, or 2) lead-based die adhesive used between the die and leadframe. The component is otherwise considered Pb-Free (RoHS compatible) as defined above.

**Green (RoHS & no Sb/Br):** TI defines "Green" to mean Pb-Free (RoHS compatible), and free of Bromine (Br) and Antimony (Sb) based flame retardants (Br or Sb do not exceed 0.1% by weight in homogeneous material)

(3) MSL, Peak Temp. - The Moisture Sensitivity Level rating according to the JEDEC industry standard classifications, and peak solder temperature.

(4) There may be additional marking, which relates to the logo, the lot trace code information, or the environmental category on the device.

(5) Multiple Device Markings will be inside parentheses. Only one Device Marking contained in parentheses and separated by a "~" will appear on a device. If a line is indented then it is a continuation of the previous line and the two combined represent the entire Device Marking for that device.

(6) Lead/Ball Finish - Orderable Devices may have multiple material finish options. Finish options are separated by a vertical ruled line. Lead/Ball Finish values may wrap to two lines if the finish value exceeds the maximum column width.

**Important Information and Disclaimer:**The information provided on this page represents TI's knowledge and belief as of the date that it is provided. TI bases its knowledge and belief on information provided by third parties, and makes no representation or warranty as to the accuracy of such information. Efforts are underway to better integrate information from third parties. TI has taken and

---

continues to take reasonable steps to provide representative and accurate information but may not have conducted destructive testing or chemical analysis on incoming materials and chemicals. TI and TI suppliers consider certain information to be proprietary, and thus CAS numbers and other limited information may not be available for release.

In no event shall TI's liability arising out of such information exceed the total purchase price of the TI part(s) at issue in this document sold by TI to Customer on an annual basis.

**TAPE AND REEL INFORMATION**

**QUADRANT ASSIGNMENTS FOR PIN 1 ORIENTATION IN TAPE**

\*All dimensions are nominal

Device	Package Type	Package Drawing	Pins	SPQ	Reel Diameter (mm)	Reel Width W1 (mm)	A0 (mm)	B0 (mm)	K0 (mm)	P1 (mm)	W (mm)	Pin1 Quadrant
LMC7111BIM5	SOT-23	DBV	5	1000	178.0	8.4	3.2	3.2	1.4	4.0	8.0	Q3
LMC7111BIM5/NOPB	SOT-23	DBV	5	1000	178.0	8.4	3.2	3.2	1.4	4.0	8.0	Q3
LMC7111BIM5X	SOT-23	DBV	5	3000	178.0	8.4	3.2	3.2	1.4	4.0	8.0	Q3
LMC7111BIM5X/NOPB	SOT-23	DBV	5	3000	178.0	8.4	3.2	3.2	1.4	4.0	8.0	Q3

**TAPE AND REEL BOX DIMENSIONS**

\*All dimensions are nominal

Device	Package Type	Package Drawing	Pins	SPQ	Length (mm)	Width (mm)	Height (mm)
LMC7111BIM5	SOT-23	DBV	5	1000	210.0	185.0	35.0
LMC7111BIM5/NOPB	SOT-23	DBV	5	1000	210.0	185.0	35.0
LMC7111BIM5X	SOT-23	DBV	5	3000	210.0	185.0	35.0
LMC7111BIM5X/NOPB	SOT-23	DBV	5	3000	210.0	185.0	35.0

## GENERIC PACKAGE VIEW

DBV 5

SOT-23 - 1.45 mm max height

SMALL OUTLINE TRANSISTOR



Images above are just a representation of the package family, actual package may vary.  
Refer to the product data sheet for package details.

4073253/P



DBV0005A



# PACKAGE OUTLINE

SOT-23 - 1.45 mm max height

SMALL OUTLINE TRANSISTOR

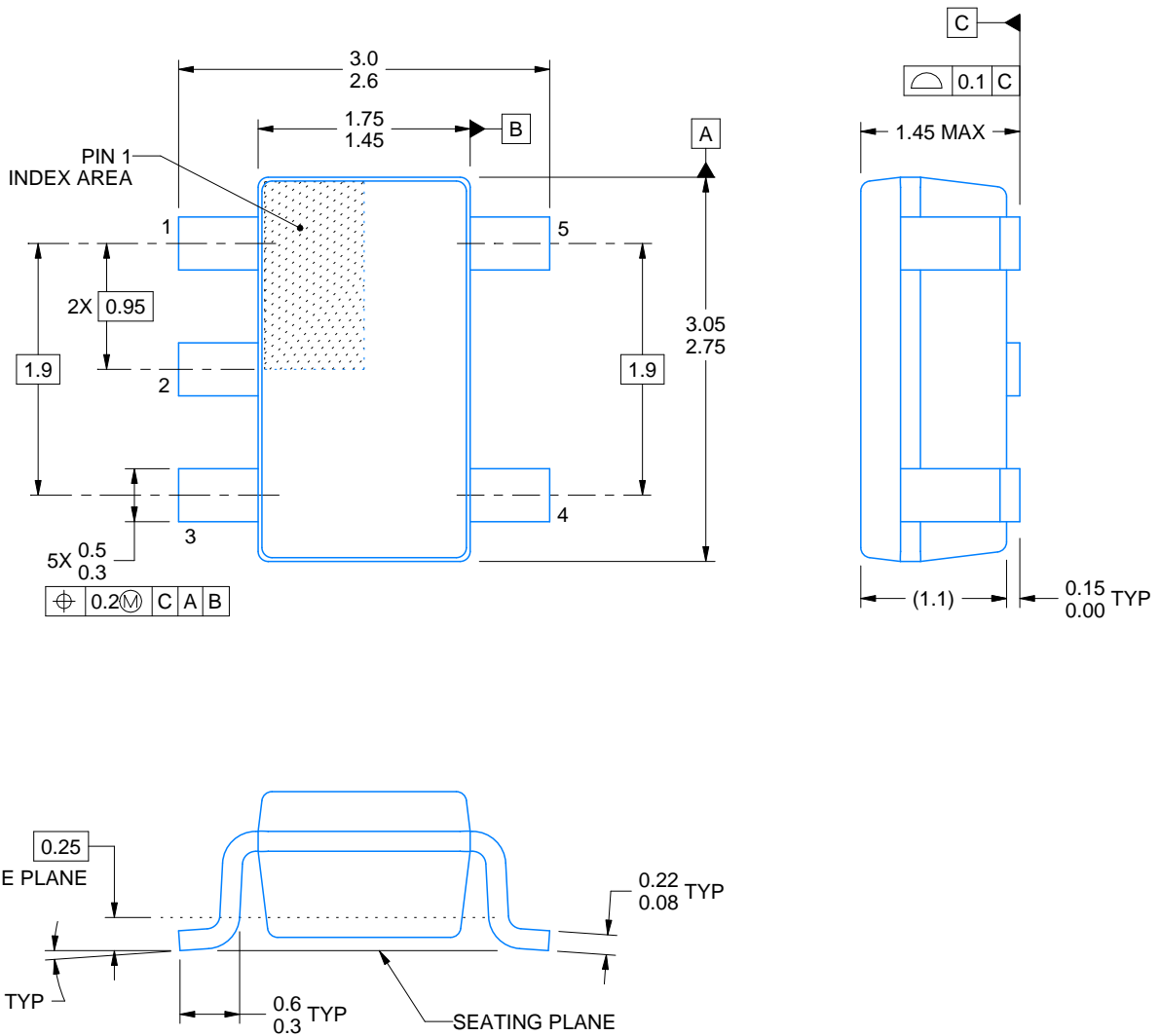

4214839/C 04/2017

NOTES:

1. All linear dimensions are in millimeters. Any dimensions in parenthesis are for reference only. Dimensioning and tolerancing per ASME Y14.5M.
2. This drawing is subject to change without notice.
3. Reference JEDEC MO-178.

# EXAMPLE BOARD LAYOUT

DBV0005A

SOT-23 - 1.45 mm max height

SMALL OUTLINE TRANSISTOR



LAND PATTERN EXAMPLE  
EXPOSED METAL SHOWN  
SCALE:15X

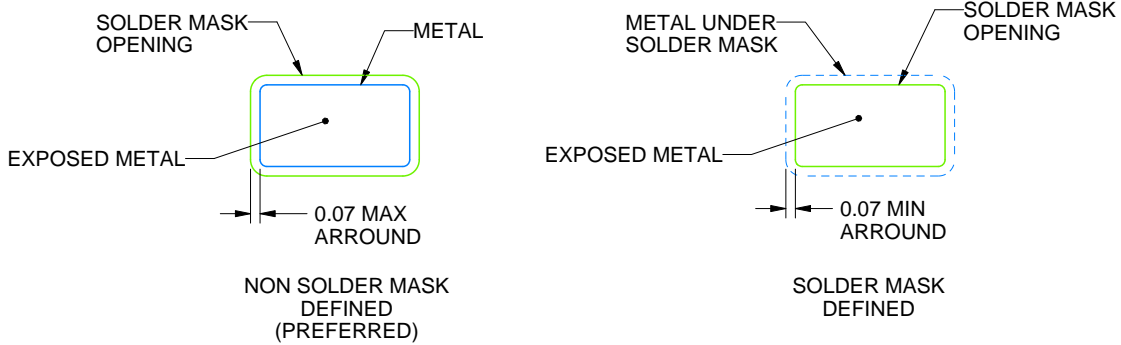

SOLDER MASK DETAILS

4214839/C 04/2017

NOTES: (continued)

- 4. Publication IPC-7351 may have alternate designs.
- 5. Solder mask tolerances between and around signal pads can vary based on board fabrication site.

# EXAMPLE STENCIL DESIGN

DBV0005A

SOT-23 - 1.45 mm max height

SMALL OUTLINE TRANSISTOR



SOLDER PASTE EXAMPLE  
BASED ON 0.125 mm THICK STENCIL  
SCALE:15X

4214839/C 04/2017

NOTES: (continued)

6. Laser cutting apertures with trapezoidal walls and rounded corners may offer better paste release. IPC-7525 may have alternate design recommendations.
7. Board assembly site may have different recommendations for stencil design.

## IMPORTANT NOTICE

Texas Instruments Incorporated (TI) reserves the right to make corrections, enhancements, improvements and other changes to its semiconductor products and services per JESD46, latest issue, and to discontinue any product or service per JESD48, latest issue. Buyers should obtain the latest relevant information before placing orders and should verify that such information is current and complete.

TI's published terms of sale for semiconductor products (<http://www.ti.com/sc/docs/stdterms.htm>) apply to the sale of packaged integrated circuit products that TI has qualified and released to market. Additional terms may apply to the use or sale of other types of TI products and services.

Reproduction of significant portions of TI information in TI data sheets is permissible only if reproduction is without alteration and is accompanied by all associated warranties, conditions, limitations, and notices. TI is not responsible or liable for such reproduced documentation. Information of third parties may be subject to additional restrictions. Resale of TI products or services with statements different from or beyond the parameters stated by TI for that product or service voids all express and any implied warranties for the associated TI product or service and is an unfair and deceptive business practice. TI is not responsible or liable for any such statements.

Buyers and others who are developing systems that incorporate TI products (collectively, "Designers") understand and agree that Designers remain responsible for using their independent analysis, evaluation and judgment in designing their applications and that Designers have full and exclusive responsibility to assure the safety of Designers' applications and compliance of their applications (and of all TI products used in or for Designers' applications) with all applicable regulations, laws and other applicable requirements. Designer represents that, with respect to their applications, Designer has all the necessary expertise to create and implement safeguards that (1) anticipate dangerous consequences of failures, (2) monitor failures and their consequences, and (3) lessen the likelihood of failures that might cause harm and take appropriate actions. Designer agrees that prior to using or distributing any applications that include TI products, Designer will thoroughly test such applications and the functionality of such TI products as used in such applications.

TI's provision of technical, application or other design advice, quality characterization, reliability data or other services or information, including, but not limited to, reference designs and materials relating to evaluation modules, (collectively, "TI Resources") are intended to assist designers who are developing applications that incorporate TI products; by downloading, accessing or using TI Resources in any way, Designer (individually or, if Designer is acting on behalf of a company, Designer's company) agrees to use any particular TI Resource solely for this purpose and subject to the terms of this Notice.

TI's provision of TI Resources does not expand or otherwise alter TI's applicable published warranties or warranty disclaimers for TI products, and no additional obligations or liabilities arise from TI providing such TI Resources. TI reserves the right to make corrections, enhancements, improvements and other changes to its TI Resources. TI has not conducted any testing other than that specifically described in the published documentation for a particular TI Resource.

Designer is authorized to use, copy and modify any individual TI Resource only in connection with the development of applications that include the TI product(s) identified in such TI Resource. NO OTHER LICENSE, EXPRESS OR IMPLIED, BY ESTOPPEL OR OTHERWISE TO ANY OTHER TI INTELLECTUAL PROPERTY RIGHT, AND NO LICENSE TO ANY TECHNOLOGY OR INTELLECTUAL PROPERTY RIGHT OF TI OR ANY THIRD PARTY IS GRANTED HEREIN, including but not limited to any patent right, copyright, mask work right, or other intellectual property right relating to any combination, machine, or process in which TI products or services are used. Information regarding or referencing third-party products or services does not constitute a license to use such products or services, or a warranty or endorsement thereof. Use of TI Resources may require a license from a third party under the patents or other intellectual property of the third party, or a license from TI under the patents or other intellectual property of TI.

TI RESOURCES ARE PROVIDED "AS IS" AND WITH ALL FAULTS. TI DISCLAIMS ALL OTHER WARRANTIES OR REPRESENTATIONS, EXPRESS OR IMPLIED, REGARDING RESOURCES OR USE THEREOF, INCLUDING BUT NOT LIMITED TO ACCURACY OR COMPLETENESS, TITLE, ANY EPIDEMIC FAILURE WARRANTY AND ANY IMPLIED WARRANTIES OF MERCHANTABILITY, FITNESS FOR A PARTICULAR PURPOSE, AND NON-INFRINGEMENT OF ANY THIRD PARTY INTELLECTUAL PROPERTY RIGHTS. TI SHALL NOT BE LIABLE FOR AND SHALL NOT DEFEND OR INDEMNIFY DESIGNER AGAINST ANY CLAIM, INCLUDING BUT NOT LIMITED TO ANY INFRINGEMENT CLAIM THAT RELATES TO OR IS BASED ON ANY COMBINATION OF PRODUCTS EVEN IF DESCRIBED IN TI RESOURCES OR OTHERWISE. IN NO EVENT SHALL TI BE LIABLE FOR ANY ACTUAL, DIRECT, SPECIAL, COLLATERAL, INDIRECT, PUNITIVE, INCIDENTAL, CONSEQUENTIAL OR EXEMPLARY DAMAGES IN CONNECTION WITH OR ARISING OUT OF TI RESOURCES OR USE THEREOF, AND REGARDLESS OF WHETHER TI HAS BEEN ADVISED OF THE POSSIBILITY OF SUCH DAMAGES.

Unless TI has explicitly designated an individual product as meeting the requirements of a particular industry standard (e.g., ISO/TS 16949 and ISO 26262), TI is not responsible for any failure to meet such industry standard requirements.

Where TI specifically promotes products as facilitating functional safety or as compliant with industry functional safety standards, such products are intended to help enable customers to design and create their own applications that meet applicable functional safety standards and requirements. Using products in an application does not by itself establish any safety features in the application. Designers must ensure compliance with safety-related requirements and standards applicable to their applications. Designer may not use any TI products in life-critical medical equipment unless authorized officers of the parties have executed a special contract specifically governing such use. Life-critical medical equipment is medical equipment where failure of such equipment would cause serious bodily injury or death (e.g., life support, pacemakers, defibrillators, heart pumps, neurostimulators, and implantables). Such equipment includes, without limitation, all medical devices identified by the U.S. Food and Drug Administration as Class III devices and equivalent classifications outside the U.S.

TI may expressly designate certain products as completing a particular qualification (e.g., Q100, Military Grade, or Enhanced Product). Designers agree that it has the necessary expertise to select the product with the appropriate qualification designation for their applications and that proper product selection is at Designers' own risk. Designers are solely responsible for compliance with all legal and regulatory requirements in connection with such selection.

Designer will fully indemnify TI and its representatives against any damages, costs, losses, and/or liabilities arising out of Designer's non-compliance with the terms and provisions of this Notice.