

## LMH6672 Dual, High Output Current, High Speed Op Amp

### 1 Features

- **High Output Drive**
  - 19.2 V<sub>PP</sub> Differential Output Voltage, R<sub>L</sub> = 50 Ω
  - 9.6 V<sub>PP</sub> Single-ended Output Voltage, R<sub>L</sub> = 25 Ω
- **High Output Current**
  - ±200 mA @ V<sub>O</sub> = 9 V<sub>PP</sub>, V<sub>S</sub> = 12 V
- **Low Distortion**
  - 105 dB SFDR @ 100 kHz, V<sub>O</sub> = 8.4 V<sub>PP</sub>, R<sub>L</sub> = 25Ω
  - 98 dB SFDR @ 1MHz, V<sub>O</sub> = 2 V<sub>PP</sub>, R<sub>L</sub> = 100 Ω
- **High Speed**
  - 90 MHz 3 dB Bandwidth (G = 2)
  - 135 V/μs Slew Rate
- **Low Noise**
  - 3.1 nV/√Hz: Input Noise Voltage
  - 1.8 pA/√Hz: Input Noise Current
- Low Supply Current: 7.2mA/amp
- Single-supply Operation: 5 V to 12 V
- Stable for Gain of +2V/V or Higher
- Available in 8-pin SOIC and SO PowerPAD (DDA)

### 2 Applications

- ADSL PCI Modem Cards
- xDSL External Modems
- Line Drivers

### 3 Description

The LMH6672 is a low cost, dual high speed op amp capable of driving signals to within 1 V of the power supply rails. It features the high output drive with low distortion required for the demanding application of a single supply xDSL line driver.

When connected as a differential output driver, the LMH6672 can drive a 50-Ω load to 16.8 V<sub>PP</sub> swing with only -98 dBc distortion, fully supporting the peak upstream power levels for upstream full-rate ADSL. The LMH6672 is fully specified for operation with 5-V and 12-V supplies. Ideal for PCI modem cards and xDSL modems.

#### Device Information<sup>(1)</sup>

PART NUMBER	PACKAGE	BODY SIZE (NOM)
LMH6672	SOIC (8)	4.89 mm x 3.90 mm

(1) For all available packages, see the orderable addendum at the end of the datasheet.

#### Typical Application

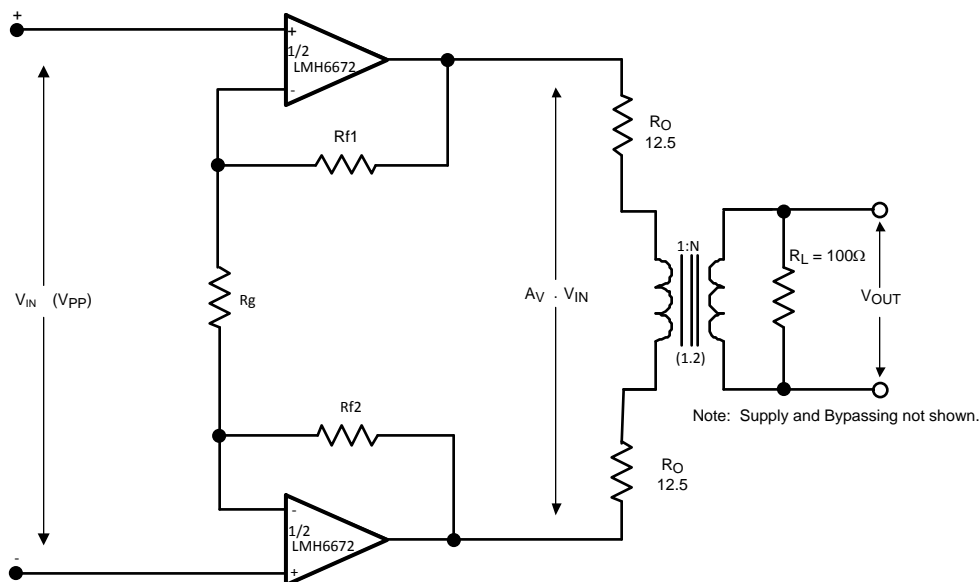

## Table of Contents

<b>1 Features</b> .....	<b>1</b>	6.6 $\pm 2.5V$ Electrical Characteristics .....	<b>6</b>
<b>2 Applications</b> .....	<b>1</b>	6.7 Typical Performance Characteristics .....	<b>7</b>
<b>3 Description</b> .....	<b>1</b>	<b>7 Detailed Description</b> .....	<b>15</b>
<b>4 Revision History</b> .....	<b>2</b>	7.1 Functional Block Diagram .....	<b>15</b>
<b>5 Pin Configuration and Functions</b> .....	<b>3</b>	<b>8 Power Supply Recommendations</b> .....	<b>16</b>
<b>6 Specifications</b> .....	<b>4</b>	8.1 Thermal Management .....	<b>16</b>
6.1 Absolute Maximum Ratings .....	<b>4</b>	<b>9 Device and Documentation Support</b> .....	<b>18</b>
6.2 Handling Ratings .....	<b>4</b>	9.1 Trademarks .....	<b>18</b>
6.3 Recommended Operating Conditions .....	<b>4</b>	9.2 Electrostatic Discharge Caution .....	<b>18</b>
6.4 Thermal Information .....	<b>4</b>	9.3 Glossary .....	<b>18</b>
6.5 Electrical Characteristics .....	<b>5</b>	<b>10 Mechanical, Packaging, and Orderable Information</b> .....	<b>18</b>

## 4 Revision History

NOTE: Page numbers for previous revisions may differ from page numbers in the current version.

<b>Changes from Revision G (March 2013) to Revision H</b>	<b>Page</b>
• Changed data sheet flow and layout to conform with new TI standards. Added the following sections: Device Information Table, Application and Implementation; Device and Documentation Support; Mechanical, Packaging, and Ordering Information .....	<b>1</b>
• Added "Stable for Gain of +2V/V or Higher" in <a href="#">Features</a> .....	<b>1</b>
• Changed from "Junction Temperature Range" to "Operating Temperature Range" in <a href="#">Recommended Operating Conditions</a> .....	<b>4</b>
• Deleted $T_J = 25^\circ C$ in <a href="#">Electrical Characteristics</a> .....	<b>5</b>
• Deleted $T_J = 25^\circ C$ and "Slew Rate" in <a href="#"><math>\pm 2.5V</math> Electrical Characteristics</a> .....	<b>6</b>
• Added condition " $A_v = + 2V/V$ " in <a href="#">Typical Performance Characteristics</a> .....	<b>7</b>
• Added " $V_s = +/- 2.5V$ " and " $V_s = +/- 6V$ " as curve labels for <a href="#">Figure 36</a> .....	<b>11</b>
• Changed curve label from 31 MHz to 13 MHz. Changed title from +5V to +5V/V in <a href="#">Figure 37</a> .....	<b>12</b>
• Changed "10V" to + "10V/V" in caption title for <a href="#">Figure 38</a> .....	<b>12</b>
• Added " $V_s = 12V$ " to <a href="#">Figure 39</a> caption title .....	<b>13</b>
• Added " $V_s = 5V$ " to <a href="#">Figure 40</a> caption title .....	<b>13</b>
• Changed from " $40 = 346 mW$ " to " $40 mW$ lower or $346 mW$ " in <a href="#">Thermal Management</a> .....	<b>17</b>
• Changed from 41 mW to 17 mW .....	<b>17</b>
• Added "from ambient" .....	<b>17</b>
• Changed sentence beginning with "Using the same $P_{DRIVER}$ as above..." .....	<b>17</b>
• Added caution note .....	<b>17</b>

<b>Changes from Revision F (March 2013) to Revision G</b>	<b>Page</b>
• Changed layout of National Data Sheet to TI format .....	<b>17</b>

## 5 Pin Configuration and Functions

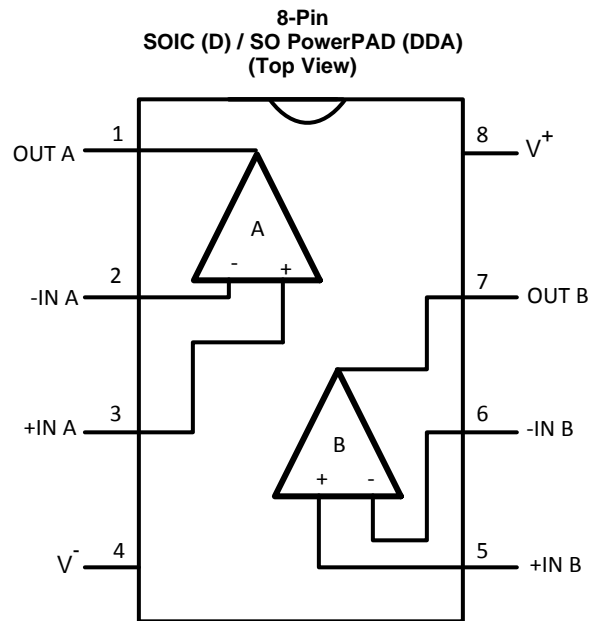

**Pin Functions**

PIN		I/O	DESCRIPTION
NUMBER	NAME		
1	OUT A	O	ChA Output
2	-IN A	I	ChA Inverting Input
3	+IN A	I	ChA Non-inverting Input
4	V <sup>-</sup>	I	Negative Supply
5	+IN B	I	ChB Non-inverting Input
6	-IN B	I	ChB Inverting Input
7	OUT B	O	ChB Output
8	V <sup>+</sup>	I	Positive Supply

## 6 Specifications

### 6.1 Absolute Maximum Ratings<sup>(1)</sup>

over operating free-air temperature range (unless otherwise noted)

		MIN	MAX	UNIT
V <sub>IN</sub> Differential			±1.2	V
Output Short Circuit Duration		See <sup>(2)</sup>		
Supply Voltage (V <sup>+</sup> - V <sup>-</sup> )			13.2	V
Voltage at Input/Output pins		V <sup>+</sup> +0.8 V <sup>-</sup> -0.8		V
Junction Temperature			+150 <sup>(3)</sup>	°C
Soldering Information	Infrared or Convection (20 sec)		235	°C
	Wave Soldering (10 sec)		260	°C

- (1) Stresses beyond those listed under *Absolute Maximum Ratings* may cause permanent damage to the device. These are stress ratings only, which do not imply functional operation of the device at these or any other conditions beyond those indicated under *Recommended Operating Conditions*. Exposure to absolute-maximum-rated conditions for extended periods may affect device reliability.
- (2) Shorting the output to either supply or ground will exceed the absolute maximum T<sub>J</sub> and can result in failure.
- (3) The maximum power dissipation is a function of T<sub>J(MAX)</sub>, R<sub>θJA</sub> and T<sub>A</sub>. The maximum allowable power dissipation at any ambient temperature is P<sub>D</sub> = (T<sub>J(MAX)</sub> - T<sub>A</sub>)/R<sub>θJA</sub>. All numbers apply for packages soldered directly onto a PC board.

### 6.2 Handling Ratings

		MIN	MAX	UNIT	
T <sub>stg</sub>	Storage temperature range	-65	+150	°C	
V <sub>(ESD)</sub>	Electrostatic discharge <sup>(1)</sup>	Human body model (HBM), per ANSI/ESDA/JEDEC JS-001, all pins <sup>(2)</sup>	2	2000	V
		Machine Model (MM) <sup>(3)</sup>		200	

- (1) Human body model, 1.5 kΩ in series with 100 pF. Machine model, 200 Ω in series with 100 pF.
- (2) JEDEC document JEP155 states that 2000-V HBM allows safe manufacturing with a standard ESD control process.
- (3) JEDEC document JEP157 states that 200-V MM allows safe manufacturing with a standard ESD control process.

### 6.3 Recommended Operating Conditions

over operating free-air temperature range (unless otherwise noted)

		MIN	MAX	UNIT
Supply Voltage (V <sup>+</sup> - V <sup>-</sup> )		±2.5	±6.5	V
Operating Temperature Range		-40	150	°C

### 6.4 Thermal Information

THERMAL METRIC <sup>(1)</sup>		SOIC Package D	SO PowerPAD Package DDA	UNIT
		8 PINS	8 PINS	
R <sub>θJA</sub>	Junction-to-ambient thermal resistance	172	58.6	°C/W

- (1) For more information about traditional and new thermal metrics, see the *IC Package Thermal Metrics* application report, [SPRA953](#).

## 6.5 Electrical Characteristics

Unless otherwise specified, all limits are ensured for  $G = +2$ ,  $V_S = \pm 2.5$  to  $\pm 6V$ ,  $R_F = R_{IN} = 470\Omega$ ,  $R_L = 100\Omega$ .

PARAMETER		TEST CONDITIONS	MIN <sup>(1)</sup>	TYP <sup>(2)</sup>	MAX <sup>(1)</sup>	UNIT
<b>DYNAMIC PERFORMANCE</b>						
-3dB Bandwidth				90		MHz
0.1dB Bandwidth		$V_S = \pm 6V$		12		MHz
Slew Rate		$V_S = \pm 6V$ , 4V Step, 10-90%		135		V/ $\mu$ s
Rise and Fall Time		$V_S = 6V$ , 4V Step, 10-90%		23.5		ns
<b>DISTORTION and NOISE RESPONSE</b>						
2 <sup>nd</sup> Harmonic Distortion		$V_O = 8.4 V_{PP}$ , $f = 100$ kHz, $R_L = 25\Omega$		-105		dBc
		$V_O = 8.4 V_{PP}$ , $f = 1$ MHz, $R_L = 100\Omega$		-90		dBc
3 <sup>rd</sup> Harmonic Distortion		$V_O = 8.4 V_{PP}$ , $f = 100$ kHz, $R_L = 25\Omega$		-110		dBc
		$V_O = 8.4 V_{PP}$ , $f = 1$ MHz, $R_L = 100\Omega$		-87		dBc
Input Noise Voltage		$f = 100$ kHz		3.1		nV/ $\sqrt{Hz}$
Input Noise Current		$f = 100$ kHz		1.8		pA/ $\sqrt{Hz}$
<b>INPUT CHARACTERISTICS</b>						
$V_{OS}$	Input Offset Voltage	$T_J = -40^\circ C$ to $125^\circ C$	-5.5	0.1	5.5	mV
			-4	-0.2	4	
$I_B$	Input Bias Current	$T_J = -40^\circ C$ to $125^\circ C$		8	16	$\mu$ A
$I_{OS}$	Input Offset Current	$T_J = -40^\circ C$ to $125^\circ C$	-2.1	0	2.1	$\mu$ A
CMVR	Common Voltage Range	$V_S = \pm 6V$	-6.0	-5.7 to 4.5	4.5	V
CMRR	Common-Mode Rejection Ratio	$V_S = \pm 6V$ , $T_J = -40^\circ C$ to $125^\circ C$	150	7.5		$\mu$ V/V
<b>TRANSFER CHARACTERISTICS</b>						
$A_{VOL}$	Voltage Gain	$R_L = 1k$ , $T_J = -40^\circ C$ to $125^\circ C$	1.0	5		V/mV
		$R_L = 25\Omega$ , $T_J = -40^\circ C$ to $125^\circ C$	0.67	3.4		V/mV
$V_O$	Output Swing	$R_L = 25\Omega$ , $V_S = \pm 6V$	-4.5	$\pm 4.8$	4.5	V
		$R_L = 25\Omega$ , $T_J = -40^\circ C$ to $125^\circ C$ , $V_S = \pm 6V$	-4.4	$\pm 4.8$	4.4	
$V_O$	Output Swing	$R_L = 1k$ , $V_S = \pm 6V$	-4.8	$\pm 4.8$	4.8	V
		$R_L = 1k$ , $T_J = -40^\circ C$ to $125^\circ C$ , $V_S = \pm 6V$	-4.7	$\pm 4.8$	4.7	
$I_{SC}$	Output Current <sup>(3)</sup>	$V_O = 0$ , $V_S = \pm 6V$	350	525		mA
		$V_O = 0$ , $V_S = \pm 6V$ , $T_J = -40^\circ C$ to $125^\circ C$	260	600		mA
<b>POWER SUPPLY</b>						
$I_S$	Supply Current/Amp	$V_S = \pm 6V$			8	mA
		$V_S = \pm 6V$ , $T_J = -40^\circ C$ to $125^\circ C$		7.2	9	
PSRR	Power Supply Rejection Ratio	$V_S = \pm 2.5V$ to $\pm 6V$ , $T_J = -40^\circ C$ to $125^\circ C$	72	88.5		dB

(1) All limits are specified by testing, characterization or statistical analysis.

(2) Typical values represent the most likely parametric norm.

(3) Shorting the output to either supply or ground will exceed the absolute maximum  $T_J$  and can result in failure.

## 6.6 ±2.5V Electrical Characteristics

Unless otherwise specified, all limits are ensured for  $G = +2$ ,  $V_S = \pm 2.5$  to  $\pm 6V$ ,  $R_F = R_{IN} = 470\Omega$ ,  $R_L = 100\Omega$ .

PARAMETER		TEST CONDITIONS	MIN <sup>(1)</sup>	TYP <sup>(2)</sup>	MAX <sup>(1)</sup>	UNIT
<b>DYNAMIC PERFORMANCE</b>						
–3 dB Bandwidth				80		MHz
0.1 dB Bandwidth				12		MHz
Rise and Fall Time		2V Step, 10-90%		14		ns
<b>DISTORTION and NOISE RESPONSE</b>						
2 <sup>nd</sup> Harmonic Distortion		$V_O = 2 V_{PP}$ , $f = 100$ kHz, $R_L = 25\Omega$		–96		dBc
		$V_O = 2 V_{PP}$ , $f = 1$ MHz, $R_L = 100\Omega$		–85		dBc
3 <sup>rd</sup> Harmonic Distortion		$V_O = 2 V_{PP}$ , $f = 100$ kHz, $R_L = 25\Omega$		–98		dBc
		$V_O = 2 V_{PP}$ , $f = 1$ MHz, $R_L = 100\Omega$		–87		dBc
<b>INPUT CHARACTERISTICS</b>						
$V_{OS}$	Input Offset Voltage	$T_J = -40^\circ\text{C}$ to $125^\circ\text{C}$	–5.5		5.5	mV
			–4.0	0.02	4.0	
$I_B$	Input Bias Current	$T_J = -40^\circ\text{C}$ to $125^\circ\text{C}$		8.0	16	$\mu\text{A}$
CMVR	Common-Mode Voltage Range		–2.5		1.0	V
CMRR	Common-Mode Rejection Ratio	$T_J = -40^\circ\text{C}$ to $125^\circ\text{C}$	150	8		$\mu\text{V/V}$
<b>TRANSFER CHARACTERISTICS</b>						
$A_{VOL}$	Voltage Gain	$R_L = 25\Omega$ , $T_J = -40^\circ\text{C}$ to $125^\circ\text{C}$	0.67	3		V/mV
		$R_L = 1k$ , $T_J = -40^\circ\text{C}$ to $125^\circ\text{C}$	1.0	4		
<b>OUTPUT CHARACTERISTICS</b>						
$V_O$	Output Voltage Swing	$R_L = 25\Omega$	1.20	1.45		V
		$R_L = 25\Omega$ , $T_J = -40^\circ\text{C}$ to $125^\circ\text{C}$	1.10	1.35		
		$R_L = 1k$	1.30	1.60		
		$R_L = 1k$ , $T_J = -40^\circ\text{C}$ to $125^\circ\text{C}$	1.25	1.50		
<b>POWER SUPPLY</b>						
$I_S$	Supply Current/Amp				8.0	mA
		$T_J = -40^\circ\text{C}$ to $125^\circ\text{C}$		6.7	9.0	

(1) All limits are specified by testing, characterization or statistical analysis.

(2) Typical values represent the most likely parametric norm.

## 6.7 Typical Performance Characteristics

$A_v = +2V/V$

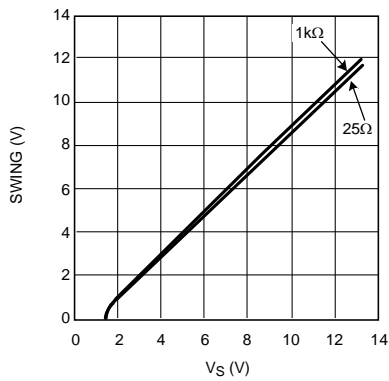

Figure 1. Output Swing  $R_L = 25\Omega, 1\text{ k}\Omega$  @  $-40^\circ\text{C}, 25^\circ\text{C}, 85^\circ\text{C}$

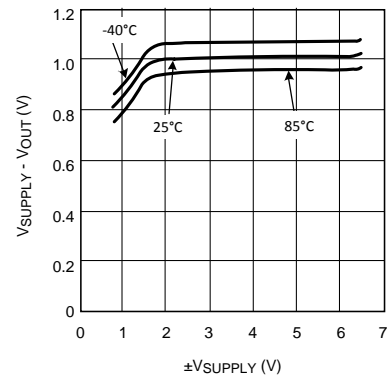

Figure 2. Positive Output Swing into 1kΩ

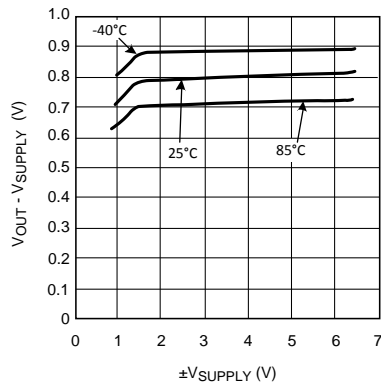

Figure 3. Negative Output Swing into 1kΩ

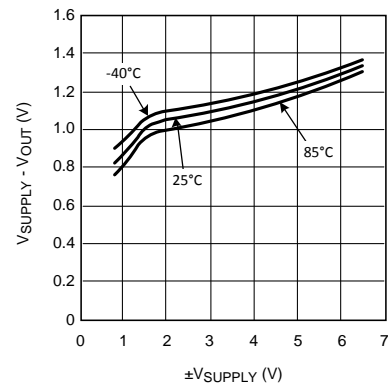

Figure 4. Positive Output Swing into 25Ω

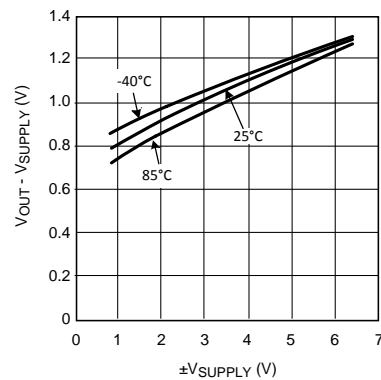

Figure 5. Negative Output Swing into 25Ω

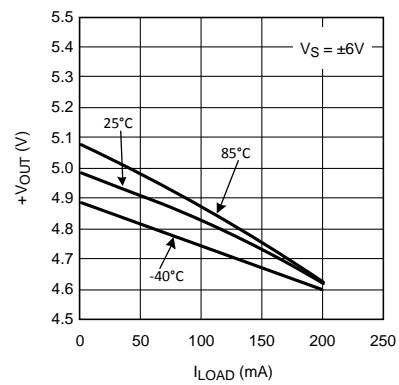
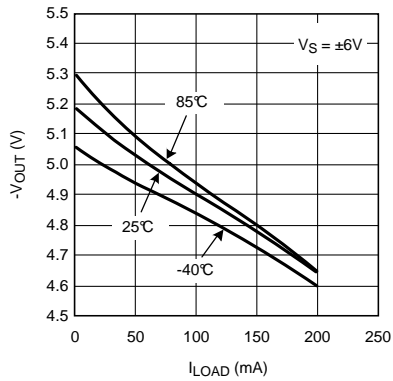

Figure 6.  $+V_{\text{OUT}}$  vs.  $I_{\text{LOAD}}$

**Typical Performance Characteristics (continued)**

$A_v = + 2V/V$



**Figure 7.  $-V_{OUT}$  vs.  $I_{LOAD}$**

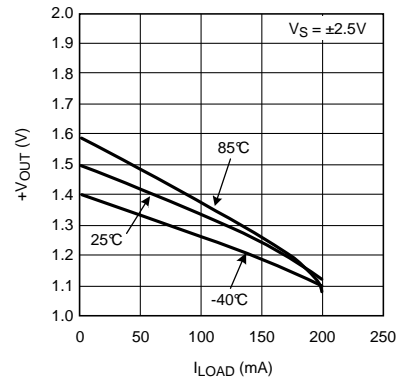

**Figure 8.  $+V_{OUT}$  vs.  $I_{LOAD}$**

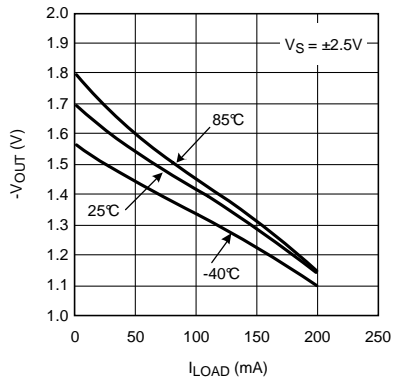

**Figure 9.  $-V_{OUT}$  vs.  $I_{LOAD}$**

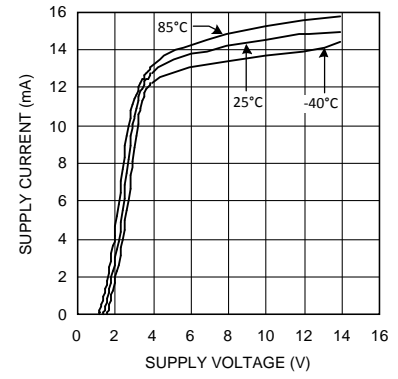

**Figure 10. Supply Current vs. Supply Voltage**

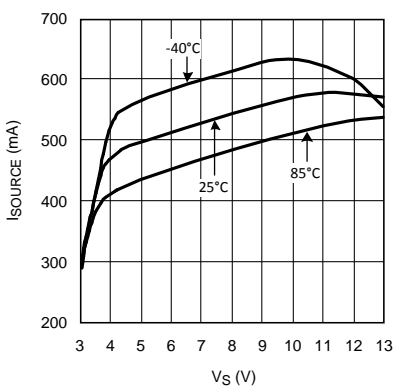

**Figure 11. Sourcing Current vs. Supply Voltage**

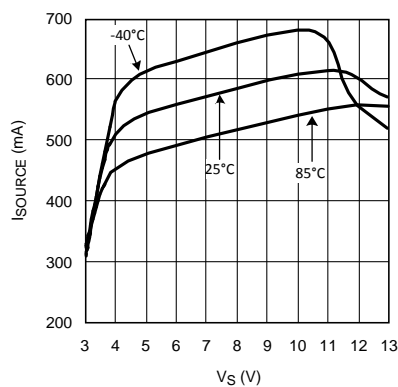

**Figure 12. Sinking Current vs. Supply Voltage**



Typical Performance Characteristics (continued)

$A_v = +2V/V$

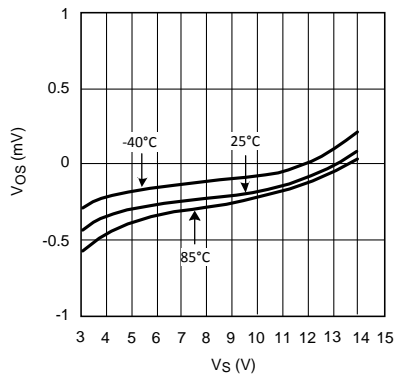

Figure 13.  $V_{OS}$  vs.  $V_S$

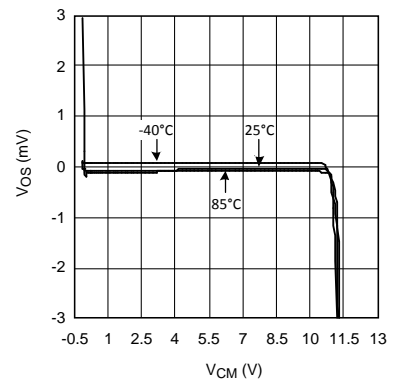

Figure 14.  $V_{OS}$  vs.  $V_{CM}$ ,  $V_S = 12V$

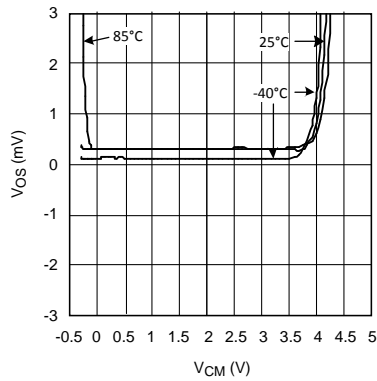

Figure 15.  $V_{OS}$  vs.  $V_{CM}$ ,  $V_S = 5V$

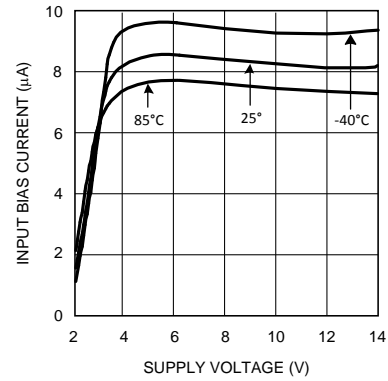

Figure 16. Bias Current vs.  $V_{SUPPLY}$

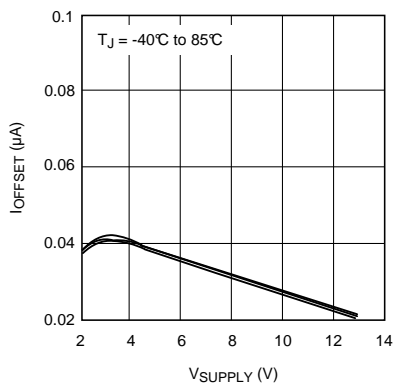

Figure 17. Offset Current vs.  $V_{SUPPLY}$

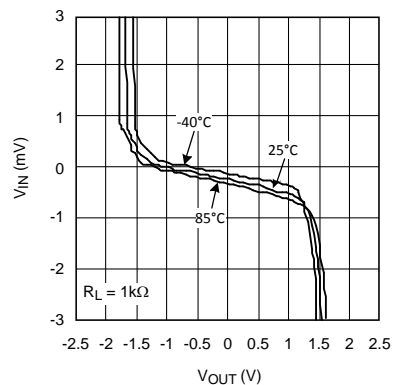

Figure 18.  $V_{OUT}$  vs.  $V_{IN}$

Typical Performance Characteristics (continued)

$A_v = +2V/V$

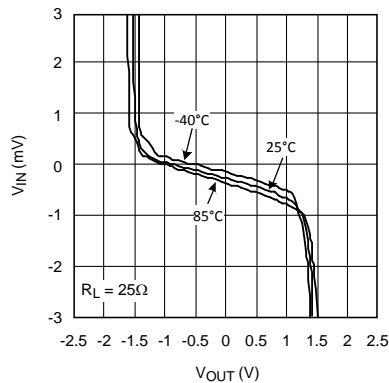

Figure 19.  $V_{OUT}$  vs.  $V_{IN}$

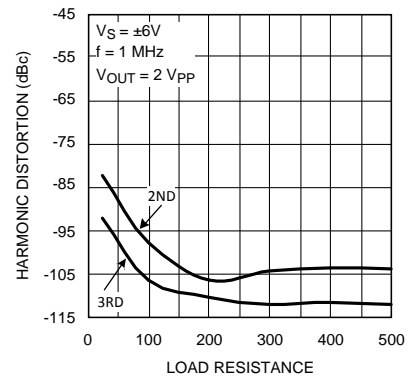

Figure 20. Harmonic Distortion vs. Load

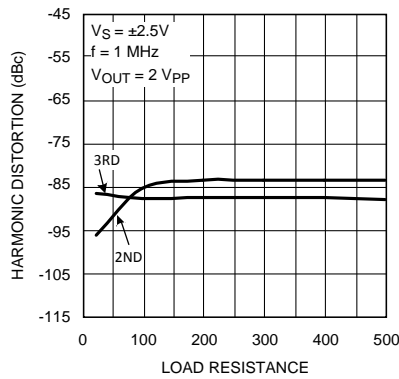

Figure 21. Harmonic Distortion vs. Load

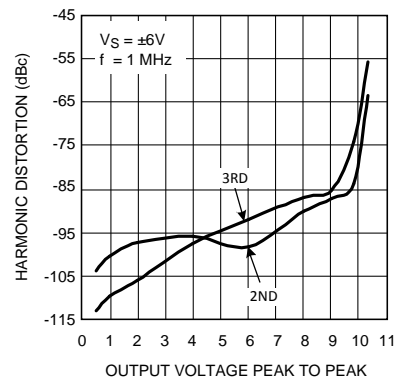

Figure 22. Harmonic Distortion vs. Output Voltage

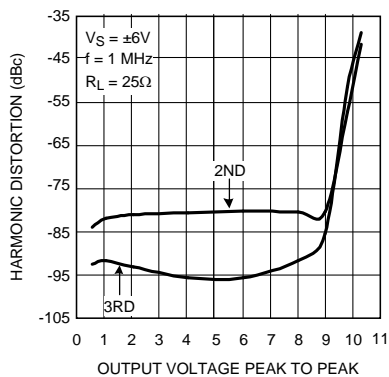

Figure 23. Harmonic Distortion vs. Output Voltage

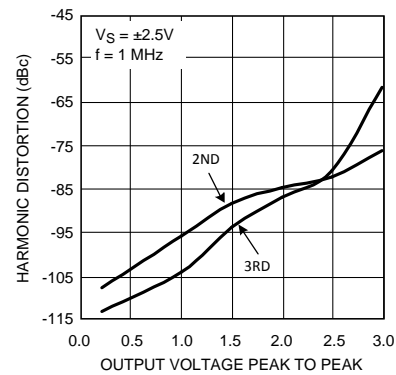

Figure 24. Harmonic Distortion vs. Output Voltage

Typical Performance Characteristics (continued)

$A_v = +2V/V$

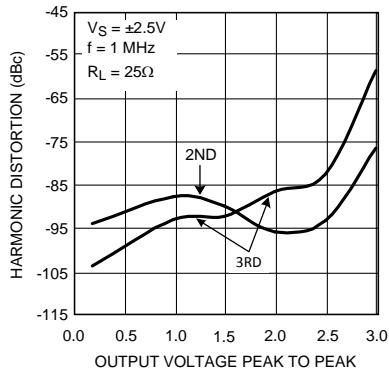

Figure 25. Harmonic Distortion vs. Output Voltage

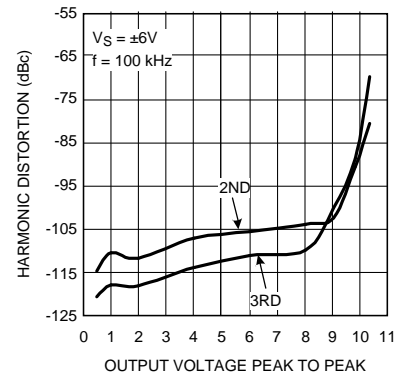

Figure 26. Harmonic Distortion vs. Output Voltage

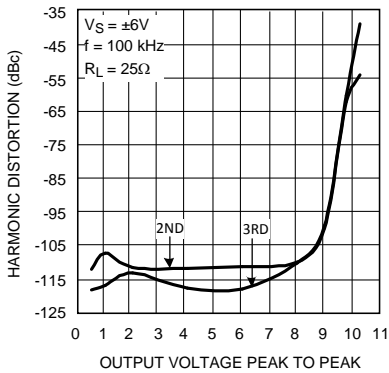

Figure 27. Harmonic Distortion vs. Output Voltage

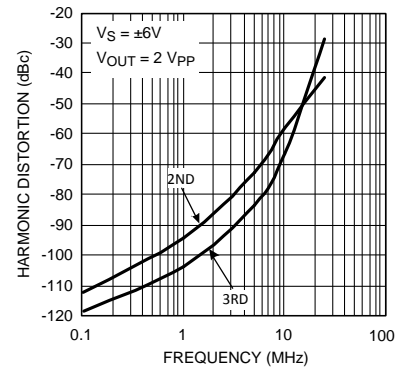

Figure 28. Harmonic Distortion vs. Frequency

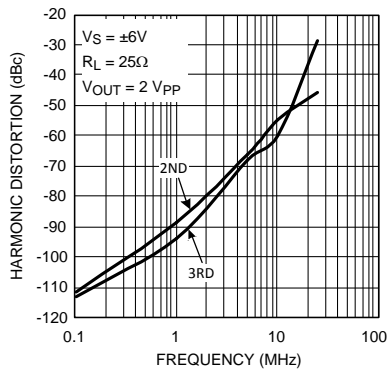

Figure 29. Harmonic Distortion vs. Frequency

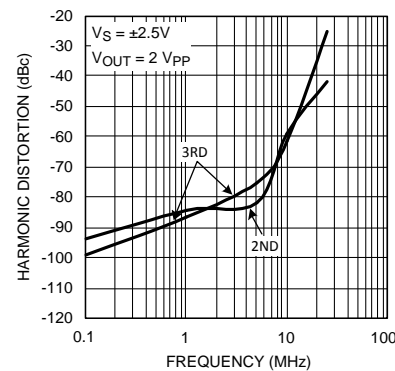

Figure 30. Harmonic Distortion vs. Frequency

Typical Performance Characteristics (continued)

$A_v = +2V/V$

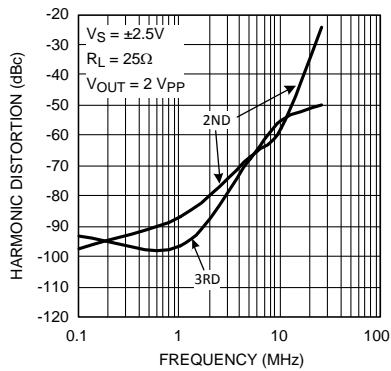

Figure 31. Harmonic Distortion vs. Frequency

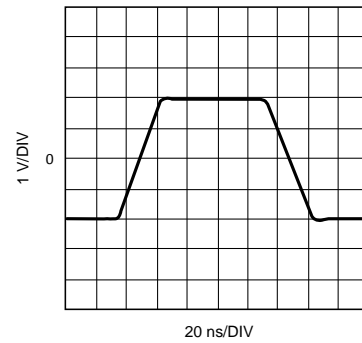

Figure 32. Pulse Response,  $V_S = \pm 6V$

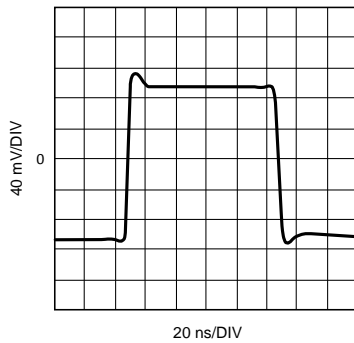

Figure 33. Pulse Response,  $V_S = \pm 2.5V, \pm 6V$

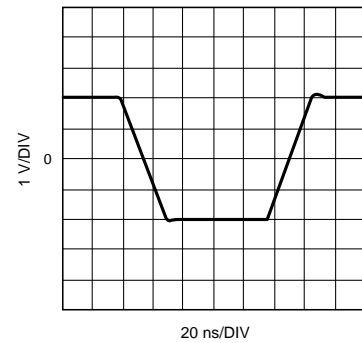

Figure 34. Pulse Response,  $A_{VCL} = -1, V_S = \pm 6V$

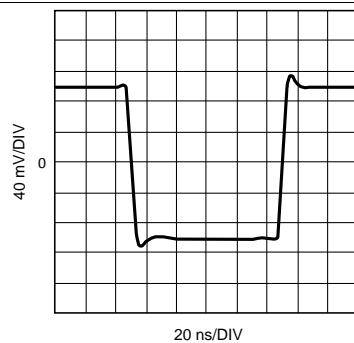

Figure 35. Pulse Response,  $A_{VCL} = -1, V_S = \pm 2.5V, \pm 6V$

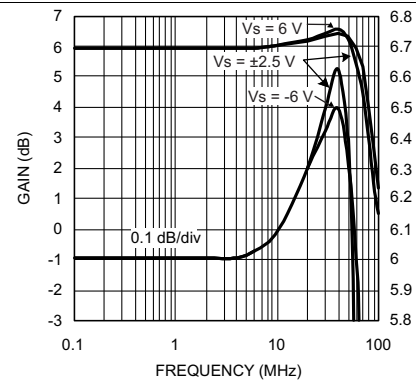
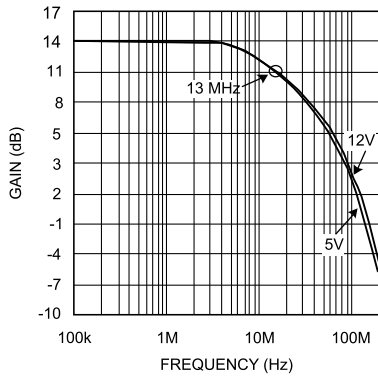

Figure 36. Frequency Response

**Typical Performance Characteristics (continued)**

$A_v = +2V/V$



**Figure 37. Frequency Response,  $A_{VCL} = +5V/V$**

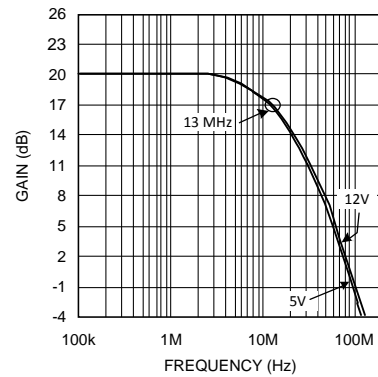

**Figure 38. Frequency Response,  $A_{VCL} = +10V/V$**

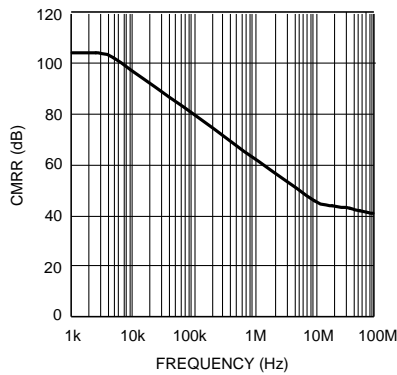

**Figure 39. CMRR vs. Frequency,  $V_S = 12V$**

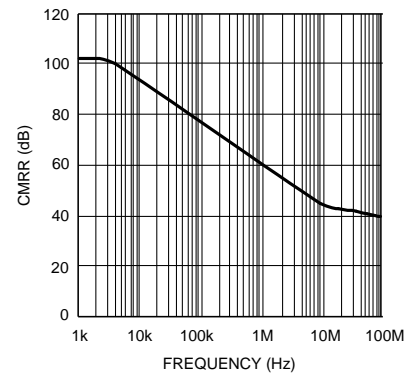

**Figure 40. CMRR vs. Frequency,  $V_S = 5V$**

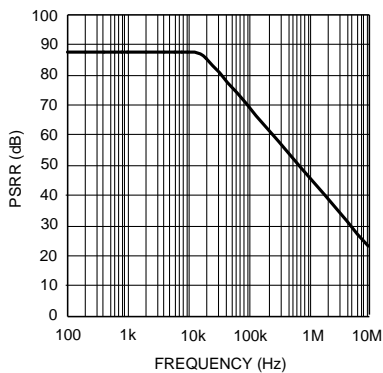

**Figure 41. PSRR+ vs. Frequency,  $V_S = 5V$  and  $12V$**

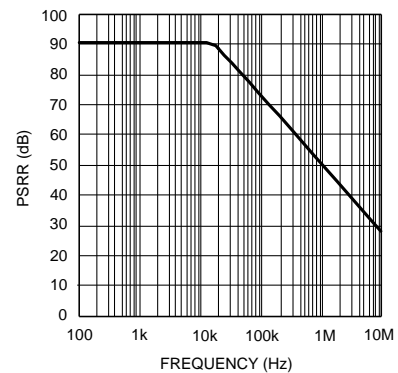

**Figure 42. PSRR- vs. Frequency  $V_S = 5V$  and  $12V$**

**Typical Performance Characteristics (continued)**

$A_v = +2V/V$

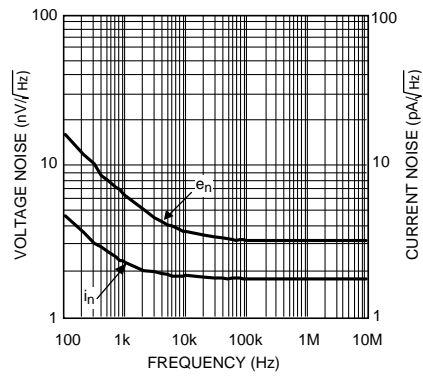

**Figure 43.  $e_n$  &  $i_n$  vs. Frequency,  $V_S = 5V$  and  $12V$**

## 7 Detailed Description

### 7.1 Functional Block Diagram

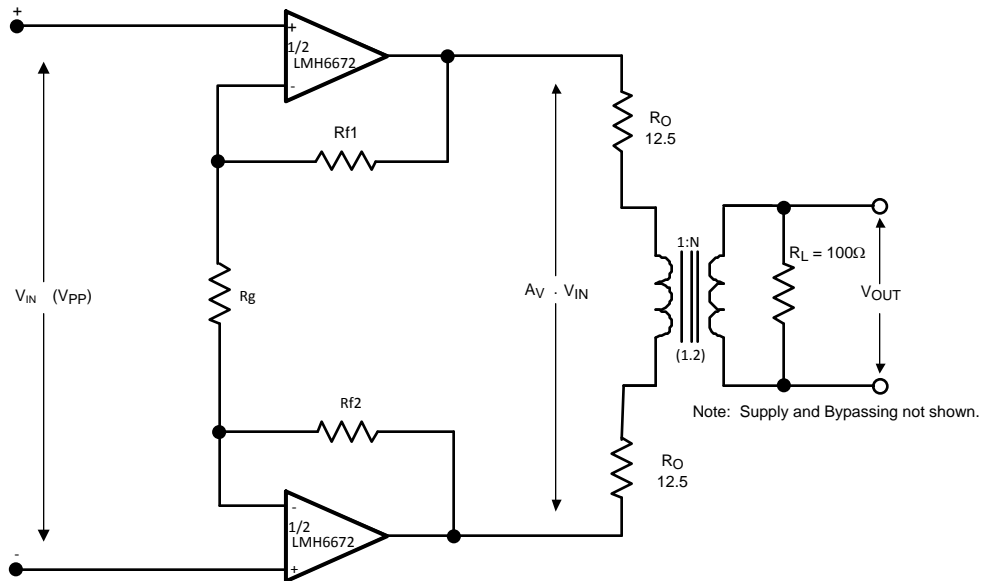

Figure 44. LMH6672 Block Diagram

## 8 Power Supply Recommendations

### 8.1 Thermal Management

The LMH6672 is a high-speed, high power, dual operational amplifier with a very high slew rate and very low distortion. For ease of use, it uses conventional voltage feedback. These characteristics make the LMH6672 ideal for applications where driving low impedances of 25 to 100  $\Omega$  such as xDSL and active filters.

A class AB output stage allows the LMH6672 to deliver high currents to low impedance loads with low distortion while consuming low quiescent supply current. For most op-amps, class AB topology means that internal power dissipation is rarely an issue, even with the trend to smaller surface mount packages. However, the LMH6672 has been designed for applications where high levels of power dissipation may be encountered.

Several factors contribute to power dissipation and consequently higher junction temperatures. These factors need to be well understood if the LMH6672 is to perform to specifications in all applications. This section will examine the typical application shown in [Figure 44](#) as an example. Because both amplifiers are in a single package, the calculations are for the total power dissipated by both amplifiers.

There are two separate contributors to the internal power dissipation:

1. The product of the supply voltage and the quiescent current when no signal is being delivered to the external load.
2. The additional power dissipated while delivering power to the external load.

The first of these components appears easy to calculate simply by inspecting the data sheet. The typical quiescent supply current for this part is 7.2 mA per amplifier. Therefore, with a  $\pm 6$  volt supply, the total power dissipation is:

$$P_D = V_S \times 2 \times I_Q = 12 \times (14.4 \times 10^{-3}) = 173 \text{ mW}$$

where

$$\bullet \quad (V_S = V_{CC} + V_{EE}) \tag{1}$$

With a thermal resistance of 172°C/W for the SOIC package, this level of internal power dissipation will result in a junction temperature ( $T_J$ ) of 30°C above ambient.

Using the worst-case maximum supply current of 18 mA and an ambient of 85°C, a similar calculation results in a power dissipation of 216 mW, or a  $T_J$  of 122°C.

This is approaching the maximum allowed  $T_J$  of 150°C before a signal is applied. Fortunately, in normal operation, this term is reduced, for reasons that will soon be explained.

The second contributor to high  $T_J$  is the power dissipated internally when power is delivered to the external load. This cause of temperature rise is more difficult to calculate, even when the actual operating conditions are known.

To maintain low distortion, in a Class AB output stage, an idle current,  $I_Q$ , is maintained through the output transistors when there is little or no output signal. In the LMH6672, about 4.8 mA of the total quiescent supply current of 14.4 mA flows through the output stages.

Under normal large signal conditions, as the output voltage swings positive, one transistor of the output pair will conduct the load current, while the other transistor shuts off, and dissipates no power. During the negative signal swing this situation is reversed, with the lower transistor sinking the load current while the upper transistor is cut off. The current in each transistor will approximate a half wave rectified version of the total load current.

Because the output stage idle current is now routed into the load, 4.8 mA can be subtracted from the quiescent supply current when calculating the quiescent power when the output is driving a load.



## Thermal Management (continued)

The power dissipation caused by driving a load in a DSL application, using a 1:2 turns ratio transformer driving 20 mW into the subscriber line and 20 mW into the back termination resistors, can be calculated as follows:

$$P_{\text{DRIVER}} = P_{\text{TOT}} - (P_{\text{TERM}} + P_{\text{LINE}})$$

Where

- $P_{\text{DRIVER}}$  is the LMH6672 power dissipation
- $P_{\text{TOT}}$  is the total power drawn from the power supply
- $P_{\text{TERM}}$  is the power dissipated in the back termination resistors
- $P_{\text{LINE}}$  is the power sent into the subscriber line
- At full specified power,  $P_{\text{TERM}} = P_{\text{LINE}} = 20 \text{ mW}$ ,  $P_{\text{TOT}} = V_S \times I_S$  (2)

In this application,  $V_S = 12\text{V}$ .

$$I_S = I_Q + A_{\text{VG}} |I_{\text{OUT}}| \quad (3)$$

$$I_Q = \text{the LMH6672 quiescent current minus the output stage idle current.} \quad (4)$$

$$I_Q = 14.4 - 4.8 = 9.6 \text{ mA} \quad (5)$$

Average ( $A_{\text{VG}}$ )  $|I_{\text{OUT}}|$  for a full-rate ADSL CPE application, using a 1:2 turns ratio transformer, is  $\sqrt{(40 \text{ mW}/50\Omega)} = 28.28 \text{ mA RMS}$ .

For a Gaussian signal, which the DMT ADSL signal approximates,  $A_{\text{VG}} |I_{\text{OUT}}| = \sqrt{2\pi} \times I_{\text{RMS}} = 22.6 \text{ mA}$ . Therefore,  $P_{\text{TOT}} = (22.6 \text{ mA} + 9.6 \text{ mA}) \times 12\text{V} = 386 \text{ mW}$  and  $P_{\text{DRIVER}}$  is 40 mW lower or 346 mW.

In the SOIC package, with a  $\theta_{\text{JA}}$  of  $172^\circ\text{C/W}$ , this causes a temperature rise of  $60^\circ\text{C}$ . With an ambient temperature at the maximum recommended  $85^\circ\text{C}$ , the  $T_J$  is at  $145^\circ\text{C}$ , which is below the specified  $150^\circ\text{C}$  maximum.

Even if it is assumed that the absolute maximum  $I_S$  over temperature of 18 mA, when the  $I_Q$  is scaled up proportionally to 7 mA, the  $P_{\text{DRIVER}}$  only goes up by 17 mW causing a  $62^\circ\text{C}$  rise from ambient to  $147^\circ\text{C}$ .

Although very few CPE applications will ever operate in an environment as hot as  $85^\circ\text{C}$ , if a lower  $T_J$  is desired or the LMH6672 is to be used in an application where the power dissipation is higher, the SO PowerPAD (DDA) package provides a much lower  $R_{\theta\text{JA}}$  of only  $58.6^\circ \text{C/W}$ . Using the same  $P_{\text{DRIVER}}$  as above, we find that the temperature rise is only about  $21^\circ\text{C}$ , resulting in  $T_J$  of  $106^\circ\text{C}$  with  $85^\circ\text{C}$  ambient.

---

### NOTE

Since the exposed PAD (or DAP) of the SO PowerPAD (DDA) package is internally floating, the footprint for DAP could be connected to ground plane in PCB for better heat dissipation.

---

## 9 Device and Documentation Support

### 9.1 Trademarks

All trademarks are the property of their respective owners.

### 9.2 Electrostatic Discharge Caution



These devices have limited built-in ESD protection. The leads should be shorted together or the device placed in conductive foam during storage or handling to prevent electrostatic damage to the MOS gates.

### 9.3 Glossary

[SLYZ022](#) — *TI Glossary*.

This glossary lists and explains terms, acronyms, and definitions.

## 10 Mechanical, Packaging, and Orderable Information

The following pages include mechanical, packaging, and orderable information. This information is the most current data available for the designated devices. This data is subject to change without notice and revision of this document. For browser-based versions of this data sheet, refer to the left-hand navigation.

## PACKAGING INFORMATION

Orderable Device	Status (1)	Package Type	Package Drawing	Pins	Package Qty	Eco Plan (2)	Lead/Ball Finish (6)	MSL Peak Temp (3)	Op Temp (°C)	Device Marking (4/5)	Samples
LMH6672MA/NOPB	ACTIVE	SOIC	D	8	95	Green (RoHS & no Sb/Br)	CU SN	Level-1-260C-UNLIM	-40 to 85	LMH66 72MA	<a href="#">Samples</a>
LMH6672MAX/NOPB	ACTIVE	SOIC	D	8	2500	Green (RoHS & no Sb/Br)	CU SN	Level-1-260C-UNLIM	-40 to 85	LMH66 72MA	<a href="#">Samples</a>
LMH6672MR/NOPB	ACTIVE	SO PowerPAD	DDA	8	95	Green (RoHS & no Sb/Br)	CU SN	Level-3-260C-168 HR	-40 to 85	LMH66 72MR	<a href="#">Samples</a>
LMH6672MRX/NOPB	ACTIVE	SO PowerPAD	DDA	8	2500	Green (RoHS & no Sb/Br)	CU SN	Level-3-260C-168 HR	-40 to 85	LMH66 72MR	<a href="#">Samples</a>

(1) The marketing status values are defined as follows:

**ACTIVE:** Product device recommended for new designs.

**LIFEBUY:** TI has announced that the device will be discontinued, and a lifetime-buy period is in effect.

**NRND:** Not recommended for new designs. Device is in production to support existing customers, but TI does not recommend using this part in a new design.

**PREVIEW:** Device has been announced but is not in production. Samples may or may not be available.

**OBSOLETE:** TI has discontinued the production of the device.

(2) Eco Plan - The planned eco-friendly classification: Pb-Free (RoHS), Pb-Free (RoHS Exempt), or Green (RoHS & no Sb/Br) - please check <http://www.ti.com/productcontent> for the latest availability information and additional product content details.

**TBD:** The Pb-Free/Green conversion plan has not been defined.

**Pb-Free (RoHS):** TI's terms "Lead-Free" or "Pb-Free" mean semiconductor products that are compatible with the current RoHS requirements for all 6 substances, including the requirement that lead not exceed 0.1% by weight in homogeneous materials. Where designed to be soldered at high temperatures, TI Pb-Free products are suitable for use in specified lead-free processes.

**Pb-Free (RoHS Exempt):** This component has a RoHS exemption for either 1) lead-based flip-chip solder bumps used between the die and package, or 2) lead-based die adhesive used between the die and leadframe. The component is otherwise considered Pb-Free (RoHS compatible) as defined above.

**Green (RoHS & no Sb/Br):** TI defines "Green" to mean Pb-Free (RoHS compatible), and free of Bromine (Br) and Antimony (Sb) based flame retardants (Br or Sb do not exceed 0.1% by weight in homogeneous material)

(3) MSL, Peak Temp. - The Moisture Sensitivity Level rating according to the JEDEC industry standard classifications, and peak solder temperature.

(4) There may be additional marking, which relates to the logo, the lot trace code information, or the environmental category on the device.

(5) Multiple Device Markings will be inside parentheses. Only one Device Marking contained in parentheses and separated by a "~" will appear on a device. If a line is indented then it is a continuation of the previous line and the two combined represent the entire Device Marking for that device.

(6) Lead/Ball Finish - Orderable Devices may have multiple material finish options. Finish options are separated by a vertical ruled line. Lead/Ball Finish values may wrap to two lines if the finish value exceeds the maximum column width.

**Important Information and Disclaimer:** The information provided on this page represents TI's knowledge and belief as of the date that it is provided. TI bases its knowledge and belief on information provided by third parties, and makes no representation or warranty as to the accuracy of such information. Efforts are underway to better integrate information from third parties. TI has taken and continues to take reasonable steps to provide representative and accurate information but may not have conducted destructive testing or chemical analysis on incoming materials and chemicals. TI and TI suppliers consider certain information to be proprietary, and thus CAS numbers and other limited information may not be available for release.

In no event shall TI's liability arising out of such information exceed the total purchase price of the TI part(s) at issue in this document sold by TI to Customer on an annual basis.

**TAPE AND REEL INFORMATION**

**QUADRANT ASSIGNMENTS FOR PIN 1 ORIENTATION IN TAPE**

\*All dimensions are nominal

Device	Package Type	Package Drawing	Pins	SPQ	Reel Diameter (mm)	Reel Width W1 (mm)	A0 (mm)	B0 (mm)	K0 (mm)	P1 (mm)	W (mm)	Pin1 Quadrant
LMH6672MAX/NOPB	SOIC	D	8	2500	330.0	12.4	6.5	5.4	2.0	8.0	12.0	Q1
LMH6672MRX/NOPB	SO Power PAD	DDA	8	2500	330.0	12.4	6.5	5.4	2.0	8.0	12.0	Q1

**TAPE AND REEL BOX DIMENSIONS**

\*All dimensions are nominal

Device	Package Type	Package Drawing	Pins	SPQ	Length (mm)	Width (mm)	Height (mm)
LMH6672MAX/NOPB	SOIC	D	8	2500	367.0	367.0	35.0
LMH6672MRX/NOPB	SO PowerPAD	DDA	8	2500	367.0	367.0	35.0

DDA (R-PDSO-G8)

PowerPAD™ PLASTIC SMALL OUTLINE

## THERMAL INFORMATION

This PowerPAD™ package incorporates an exposed thermal pad that is designed to be attached to a printed circuit board (PCB). The thermal pad must be soldered directly to the PCB. After soldering, the PCB can be used as a heatsink. In addition, through the use of thermal vias, the thermal pad can be attached directly to the appropriate copper plane shown in the electrical schematic for the device, or alternatively, can be attached to a special heatsink structure designed into the PCB. This design optimizes the heat transfer from the integrated circuit (IC).

For additional information on the PowerPAD package and how to take advantage of its heat dissipating abilities, refer to Technical Brief, PowerPAD Thermally Enhanced Package, Texas Instruments Literature No. SLMA002 and Application Brief, PowerPAD Made Easy, Texas Instruments Literature No. SLMA004. Both documents are available at [www.ti.com](http://www.ti.com).

The exposed thermal pad dimensions for this package are shown in the following illustration.

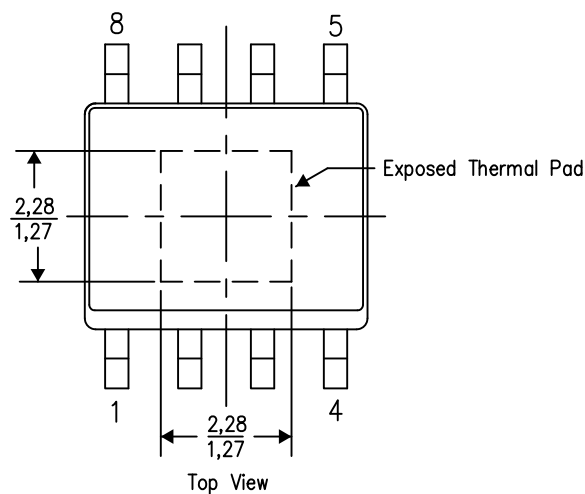

Exposed Thermal Pad Dimensions

4206322-2/L 05/12

NOTE: A. All linear dimensions are in millimeters

PowerPAD is a trademark of Texas Instruments

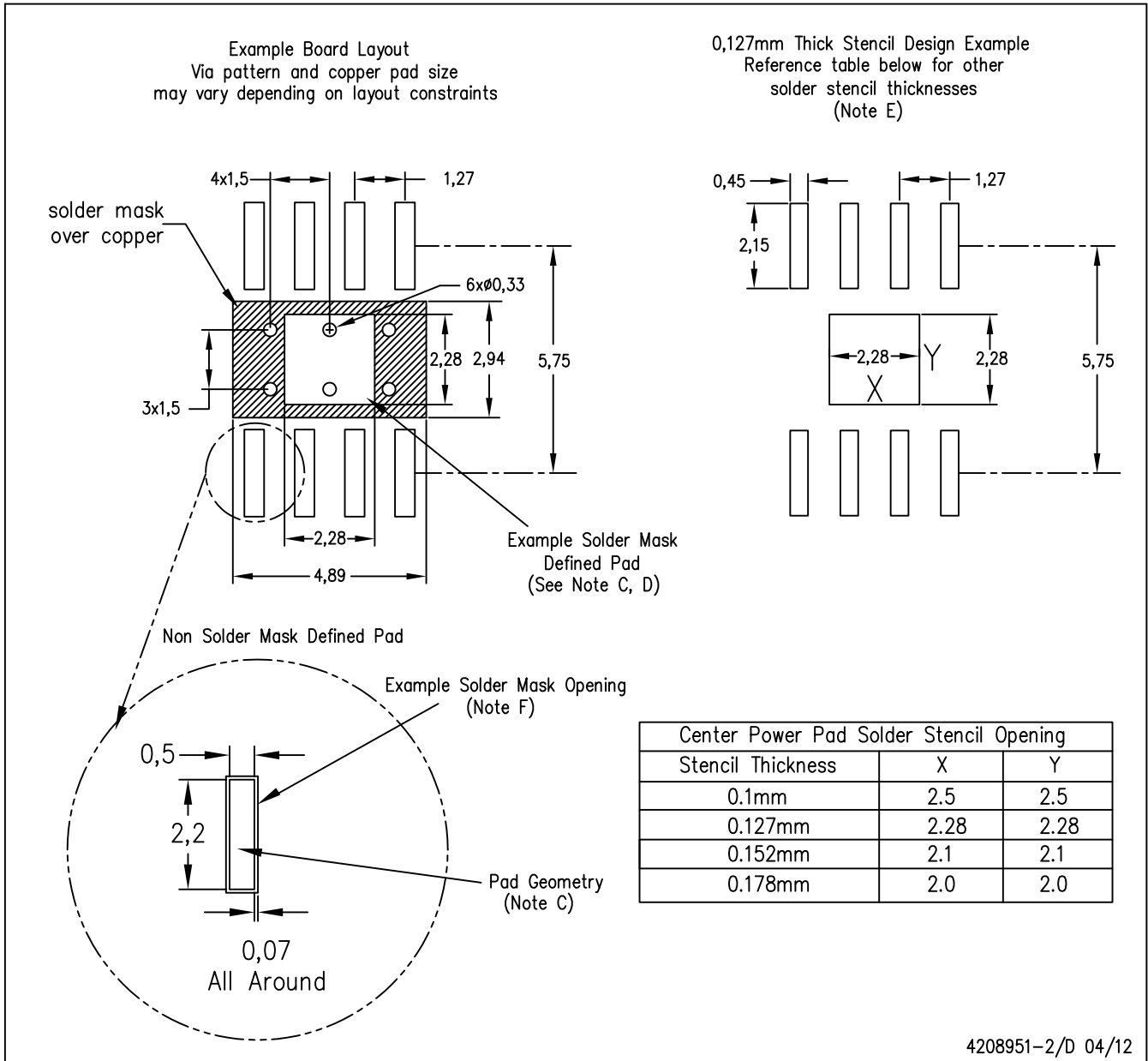

- NOTES:
- A. All linear dimensions are in millimeters.
  - B. This drawing is subject to change without notice.
  - C. Publication IPC-7351 is recommended for alternate designs.
  - D. This package is designed to be soldered to a thermal pad on the board. Refer to Technical Brief, PowerPAD Thermally Enhanced Package, Texas Instruments Literature No. SLMA002, SLMA004, and also the Product Data Sheets for specific thermal information, via requirements, and recommended board layout. These documents are available at [www.ti.com](http://www.ti.com) <<http://www.ti.com>>. Publication IPC-7351 is recommended for alternate designs.
  - E. Laser cutting apertures with trapezoidal walls and also rounding corners will offer better paste release. Customers should contact their board assembly site for stencil design recommendations. Example stencil design based on a 50% volumetric metal load solder paste. Refer to IPC-7525 for other stencil recommendations.
  - F. Customers should contact their board fabrication site for solder mask tolerances between and around signal pads.

PowerPAD is a trademark of Texas Instruments.



DDA0008A

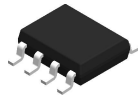

# PACKAGE OUTLINE

PowerPAD™ SOIC - 1.7 mm max height

PLASTIC SMALL OUTLINE

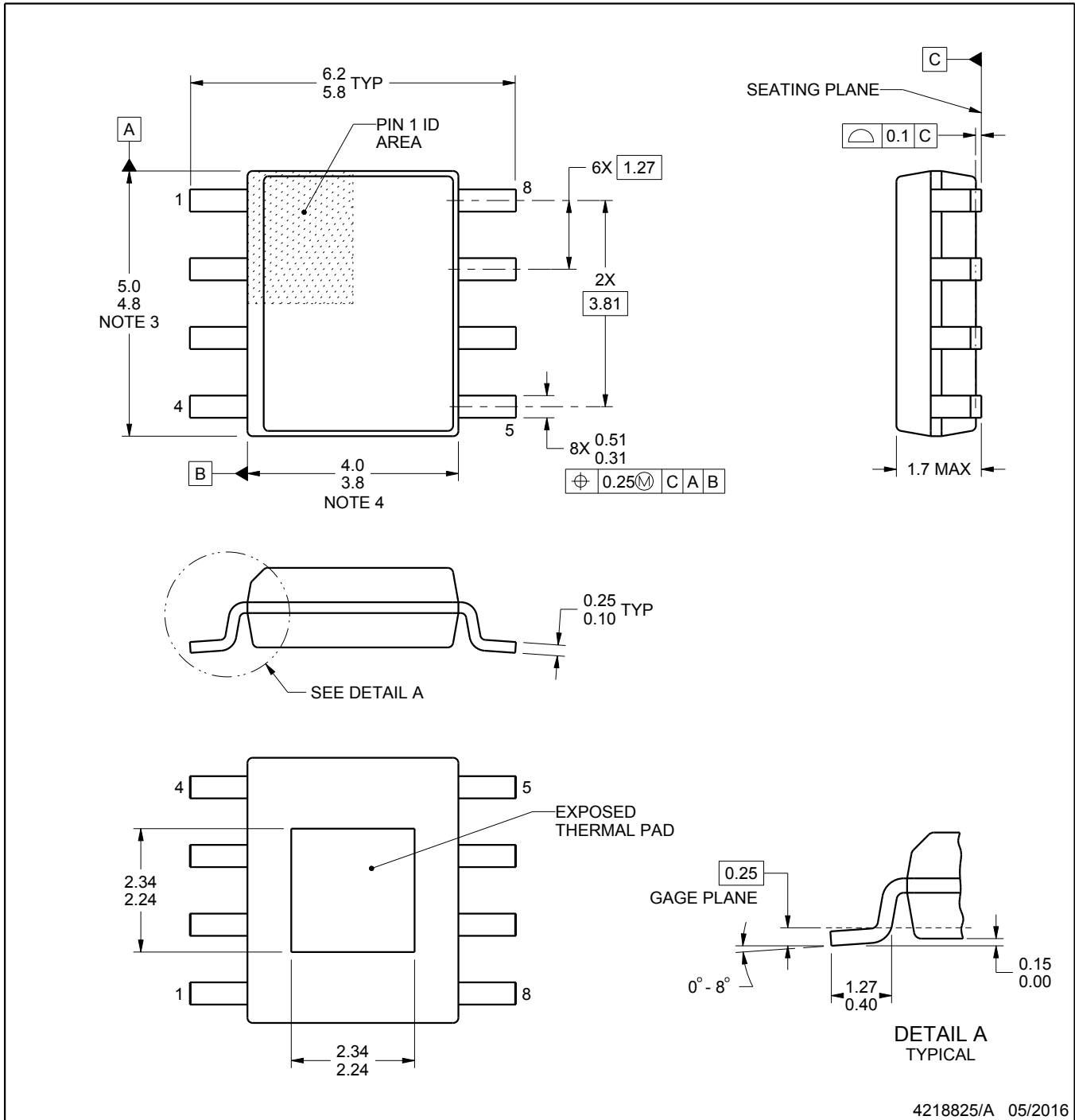

PowerPAD is a trademark of Texas Instruments.

**NOTES:**

1. All linear dimensions are in millimeters. Any dimensions in parenthesis are for reference only. Dimensioning and tolerancing per ASME Y14.5M.
2. This drawing is subject to change without notice.
3. This dimension does not include mold flash, protrusions, or gate burrs. Mold flash, protrusions, or gate burrs shall not exceed 0.15 mm per side.
4. This dimension does not include interlead flash. Interlead flash shall not exceed 0.25 mm per side.
5. Reference JEDEC registration MS-012.

# EXAMPLE BOARD LAYOUT

DDA0008A

PowerPAD™ SOIC - 1.7 mm max height

PLASTIC SMALL OUTLINE

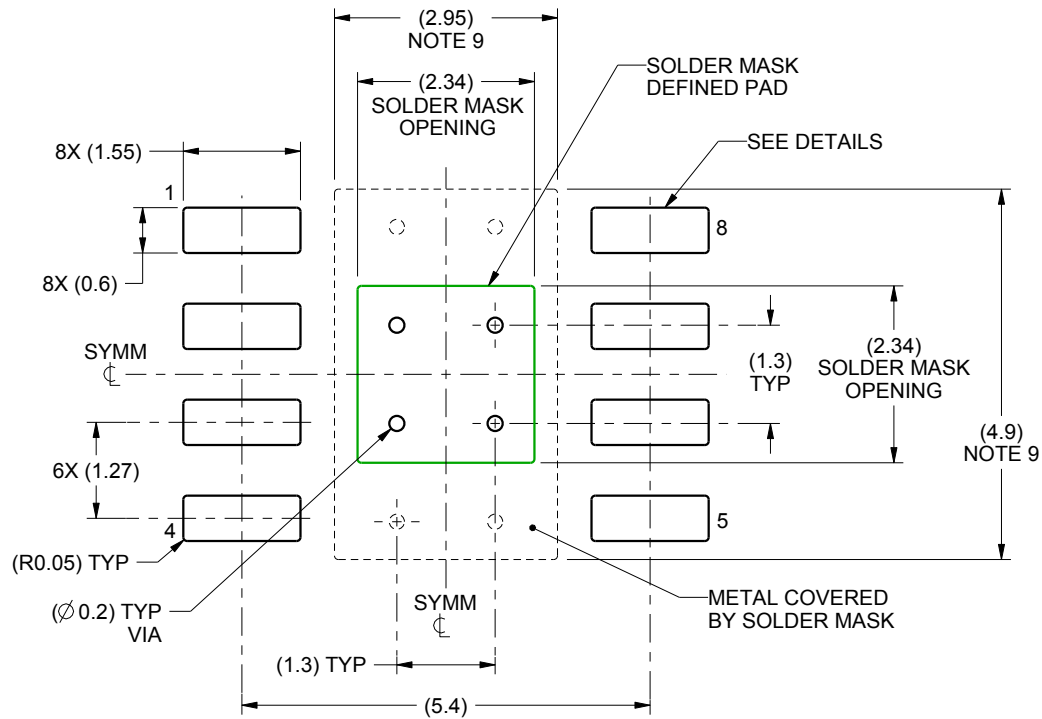

LAND PATTERN EXAMPLE  
SCALE:10X

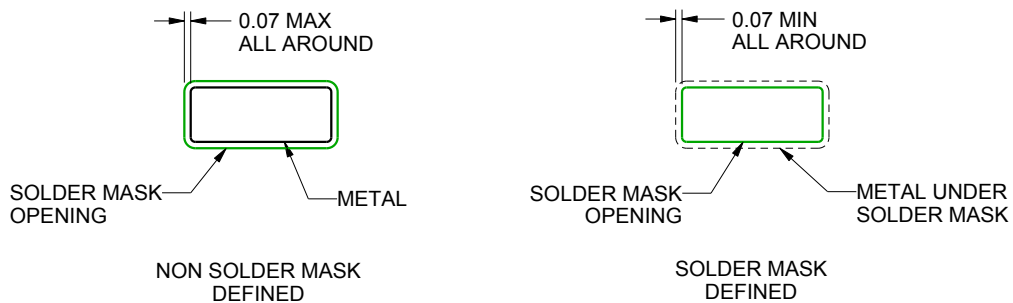

SOLDER MASK DETAILS

4218825/A 05/2016

NOTES: (continued)

6. Publication IPC-7351 may have alternate designs.
7. Solder mask tolerances between and around signal pads can vary based on board fabrication site.
8. This package is designed to be soldered to a thermal pad on the board. For more information, see Texas Instruments literature numbers SLMA002 ([www.ti.com/lit/slma002](http://www.ti.com/lit/slma002)) and SLMA004 ([www.ti.com/lit/slma004](http://www.ti.com/lit/slma004)).
9. Size of metal pad may vary due to creepage requirement.
10. Vias are optional depending on application, refer to device data sheet. If any vias are implemented, refer to their locations shown on this view. It is recommended that vias under paste be filled, plugged or tented.

# EXAMPLE STENCIL DESIGN

DDA0008A

PowerPAD™ SOIC - 1.7 mm max height

PLASTIC SMALL OUTLINE

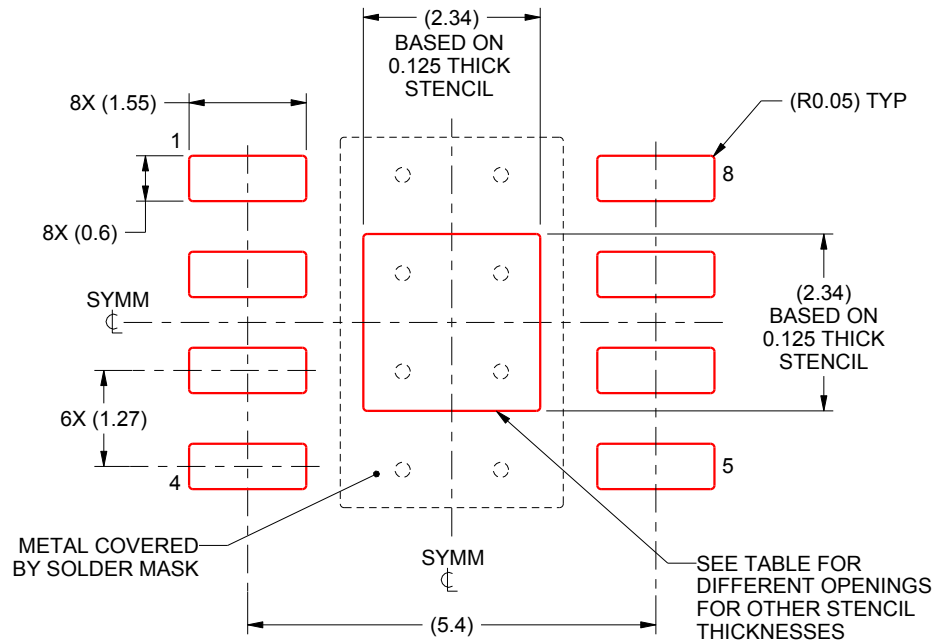

SOLDER PASTE EXAMPLE  
 EXPOSED PAD  
 100% PRINTED SOLDER COVERAGE BY AREA  
 SCALE:10X

STENCIL THICKNESS	SOLDER STENCIL OPENING
0.1	2.62 X 2.62
0.125	2.34 X 2.34 (SHOWN)
0.150	2.14 X 2.14
0.175	1.98 X 1.98

4218825/A 05/2016

NOTES: (continued)

11. Laser cutting apertures with trapezoidal walls and rounded corners may offer better paste release. IPC-7525 may have alternate design recommendations.
12. Board assembly site may have different recommendations for stencil design.

D (R-PDSO-G8)

PLASTIC SMALL OUTLINE



NOTES: A. All linear dimensions are in inches (millimeters).  
 B. This drawing is subject to change without notice.  
 C. Body length does not include mold flash, protrusions, or gate burrs. Mold flash, protrusions, or gate burrs shall not exceed 0.006 (0,15) each side.  
 D. Body width does not include interlead flash. Interlead flash shall not exceed 0.017 (0,43) each side.  
 E. Reference JEDEC MS-012 variation AA.

## IMPORTANT NOTICE

Texas Instruments Incorporated (TI) reserves the right to make corrections, enhancements, improvements and other changes to its semiconductor products and services per JESD46, latest issue, and to discontinue any product or service per JESD48, latest issue. Buyers should obtain the latest relevant information before placing orders and should verify that such information is current and complete.

TI's published terms of sale for semiconductor products (<http://www.ti.com/sc/docs/stdterms.htm>) apply to the sale of packaged integrated circuit products that TI has qualified and released to market. Additional terms may apply to the use or sale of other types of TI products and services.

Reproduction of significant portions of TI information in TI data sheets is permissible only if reproduction is without alteration and is accompanied by all associated warranties, conditions, limitations, and notices. TI is not responsible or liable for such reproduced documentation. Information of third parties may be subject to additional restrictions. Resale of TI products or services with statements different from or beyond the parameters stated by TI for that product or service voids all express and any implied warranties for the associated TI product or service and is an unfair and deceptive business practice. TI is not responsible or liable for any such statements.

Buyers and others who are developing systems that incorporate TI products (collectively, "Designers") understand and agree that Designers remain responsible for using their independent analysis, evaluation and judgment in designing their applications and that Designers have full and exclusive responsibility to assure the safety of Designers' applications and compliance of their applications (and of all TI products used in or for Designers' applications) with all applicable regulations, laws and other applicable requirements. Designer represents that, with respect to their applications, Designer has all the necessary expertise to create and implement safeguards that (1) anticipate dangerous consequences of failures, (2) monitor failures and their consequences, and (3) lessen the likelihood of failures that might cause harm and take appropriate actions. Designer agrees that prior to using or distributing any applications that include TI products, Designer will thoroughly test such applications and the functionality of such TI products as used in such applications.

TI's provision of technical, application or other design advice, quality characterization, reliability data or other services or information, including, but not limited to, reference designs and materials relating to evaluation modules, (collectively, "TI Resources") are intended to assist designers who are developing applications that incorporate TI products; by downloading, accessing or using TI Resources in any way, Designer (individually or, if Designer is acting on behalf of a company, Designer's company) agrees to use any particular TI Resource solely for this purpose and subject to the terms of this Notice.

TI's provision of TI Resources does not expand or otherwise alter TI's applicable published warranties or warranty disclaimers for TI products, and no additional obligations or liabilities arise from TI providing such TI Resources. TI reserves the right to make corrections, enhancements, improvements and other changes to its TI Resources. TI has not conducted any testing other than that specifically described in the published documentation for a particular TI Resource.

Designer is authorized to use, copy and modify any individual TI Resource only in connection with the development of applications that include the TI product(s) identified in such TI Resource. NO OTHER LICENSE, EXPRESS OR IMPLIED, BY ESTOPPEL OR OTHERWISE TO ANY OTHER TI INTELLECTUAL PROPERTY RIGHT, AND NO LICENSE TO ANY TECHNOLOGY OR INTELLECTUAL PROPERTY RIGHT OF TI OR ANY THIRD PARTY IS GRANTED HEREIN, including but not limited to any patent right, copyright, mask work right, or other intellectual property right relating to any combination, machine, or process in which TI products or services are used. Information regarding or referencing third-party products or services does not constitute a license to use such products or services, or a warranty or endorsement thereof. Use of TI Resources may require a license from a third party under the patents or other intellectual property of the third party, or a license from TI under the patents or other intellectual property of TI.

TI RESOURCES ARE PROVIDED "AS IS" AND WITH ALL FAULTS. TI DISCLAIMS ALL OTHER WARRANTIES OR REPRESENTATIONS, EXPRESS OR IMPLIED, REGARDING RESOURCES OR USE THEREOF, INCLUDING BUT NOT LIMITED TO ACCURACY OR COMPLETENESS, TITLE, ANY EPIDEMIC FAILURE WARRANTY AND ANY IMPLIED WARRANTIES OF MERCHANTABILITY, FITNESS FOR A PARTICULAR PURPOSE, AND NON-INFRINGEMENT OF ANY THIRD PARTY INTELLECTUAL PROPERTY RIGHTS. TI SHALL NOT BE LIABLE FOR AND SHALL NOT DEFEND OR INDEMNIFY DESIGNER AGAINST ANY CLAIM, INCLUDING BUT NOT LIMITED TO ANY INFRINGEMENT CLAIM THAT RELATES TO OR IS BASED ON ANY COMBINATION OF PRODUCTS EVEN IF DESCRIBED IN TI RESOURCES OR OTHERWISE. IN NO EVENT SHALL TI BE LIABLE FOR ANY ACTUAL, DIRECT, SPECIAL, COLLATERAL, INDIRECT, PUNITIVE, INCIDENTAL, CONSEQUENTIAL OR EXEMPLARY DAMAGES IN CONNECTION WITH OR ARISING OUT OF TI RESOURCES OR USE THEREOF, AND REGARDLESS OF WHETHER TI HAS BEEN ADVISED OF THE POSSIBILITY OF SUCH DAMAGES.

Unless TI has explicitly designated an individual product as meeting the requirements of a particular industry standard (e.g., ISO/TS 16949 and ISO 26262), TI is not responsible for any failure to meet such industry standard requirements.

Where TI specifically promotes products as facilitating functional safety or as compliant with industry functional safety standards, such products are intended to help enable customers to design and create their own applications that meet applicable functional safety standards and requirements. Using products in an application does not by itself establish any safety features in the application. Designers must ensure compliance with safety-related requirements and standards applicable to their applications. Designer may not use any TI products in life-critical medical equipment unless authorized officers of the parties have executed a special contract specifically governing such use. Life-critical medical equipment is medical equipment where failure of such equipment would cause serious bodily injury or death (e.g., life support, pacemakers, defibrillators, heart pumps, neurostimulators, and implantables). Such equipment includes, without limitation, all medical devices identified by the U.S. Food and Drug Administration as Class III devices and equivalent classifications outside the U.S.

TI may expressly designate certain products as completing a particular qualification (e.g., Q100, Military Grade, or Enhanced Product). Designers agree that it has the necessary expertise to select the product with the appropriate qualification designation for their applications and that proper product selection is at Designers' own risk. Designers are solely responsible for compliance with all legal and regulatory requirements in connection with such selection.

Designer will fully indemnify TI and its representatives against any damages, costs, losses, and/or liabilities arising out of Designer's non-compliance with the terms and provisions of this Notice.