



Is Now Part of



ON Semiconductor®

To learn more about ON Semiconductor, please visit our website at
www.onsemi.com

Please note: As part of the Fairchild Semiconductor integration, some of the Fairchild orderable part numbers will need to change in order to meet ON Semiconductor's system requirements. Since the ON Semiconductor product management systems do not have the ability to manage part nomenclature that utilizes an underscore (_), the underscore (_) in the Fairchild part numbers will be changed to a dash (-). This document may contain device numbers with an underscore (_). Please check the ON Semiconductor website to verify the updated device numbers. The most current and up-to-date ordering information can be found at www.onsemi.com. Please email any questions regarding the system integration to Fairchild_questions@onsemi.com.

ON Semiconductor and the ON Semiconductor logo are trademarks of Semiconductor Components Industries, LLC dba ON Semiconductor or its subsidiaries in the United States and/or other countries. ON Semiconductor owns the rights to a number of patents, trademarks, copyrights, trade secrets, and other intellectual property. A listing of ON Semiconductor's product/patent coverage may be accessed at www.onsemi.com/site/pdf/Patent-Marking.pdf. ON Semiconductor reserves the right to make changes without further notice to any products herein. ON Semiconductor makes no warranty, representation or guarantee regarding the suitability of its products for any particular purpose, nor does ON Semiconductor assume any liability arising out of the application or use of any product or circuit, and specifically disclaims any and all liability, including without limitation special, consequential or incidental damages. Buyer is responsible for its products and applications using ON Semiconductor products, including compliance with all laws, regulations and safety requirements or standards, regardless of any support or applications information provided by ON Semiconductor. "Typical" parameters which may be provided in ON Semiconductor data sheets and/or specifications can and do vary in different applications and actual performance may vary over time. All operating parameters, including "Typicals" must be validated for each customer application by customer's technical experts. ON Semiconductor does not convey any license under its patent rights nor the rights of others. ON Semiconductor products are not designed, intended, or authorized for use as a critical component in life support systems or any FDA Class 3 medical devices or medical devices with a same or similar classification in a foreign jurisdiction or any devices intended for implantation in the human body. Should Buyer purchase or use ON Semiconductor products for any such unintended or unauthorized application, Buyer shall indemnify and hold ON Semiconductor and its officers, employees, subsidiaries, affiliates, and distributors harmless against all claims, costs, damages, and expenses, and reasonable attorney fees arising out of, directly or indirectly, any claim of personal injury or death associated with such unintended or unauthorized use, even if such claim alleges that ON Semiconductor was negligent regarding the design or manufacture of the part. ON Semiconductor is an Equal Opportunity/Affirmative Action Employer. This literature is subject to all applicable copyright laws and is not for resale in any manner.

NC7SV74

TinyLogic® ULP-A D-Type Flip-Flop with Preset and Clear

Features

- Space-saving US8 surface-mount package
- MicroPak™ Pb-free leadless package
- 0.9V to 3.6V V_{CC} supply operation
- 3.6V over-voltage tolerant I/Os at V_{CC} from 0.9V to 3.6V
- Extremely High Speed t_{PD}
 - 1.0 ns typ for 2.7V to 3.6V V_{CC}
 - 1.2 ns typ for 2.3V to 2.7V V_{CC}
 - 1.9 ns typ for 1.65V to 1.95V V_{CC}
 - 3.2 ns typ for 1.4V to 1.6V V_{CC}
 - 6.0 ns typ for 1.1V to 1.3V V_{CC}
 - 13.0 ns typ for 0.9V V_{CC}
- Power-off high-impedance inputs and outputs
- High static drive (I_{OH}/I_{OL})
 - ±24.0 mA @ 3.00V V_{CC}
 - ±18.0 mA @ 2.30V V_{CC}
 - ±6.0 mA @ 1.65V V_{CC}
 - ±4.0 mA @ 1.4V V_{CC}
 - ±2.0 mA @ 1.1V V_{CC}
 - ±0.1 mA @ 0.9V V_{CC}
- Ultra low dynamic power

TinyLogic® is a registered trademark of Fairchild Semiconductor Corporation.
MicroPak™ and Quiet Series™ are trademarks of Fairchild Semiconductor Corporation.

General Description

The NC7SV74 is a single D-type CMOS flip-flop with preset and clear from Fairchild's Ultra Low Power-A (ULP-A) series of TinyLogic products, in space-saving US8 and MicroPak™ packages. ULP-A is ideal for applications that require extreme high speed, high drive, and low power.

This product is designed for a wide low-voltage operating range (0.9V to 3.6V V_{CC}) and applications that require more drive and speed than the TinyLogic ULP series, but still require low power consumption.

The NC7SV74 is uniquely designed for optimized power and speed, and is fabricated with an advanced CMOS technology to achieve high-speed operation while maintaining low CMOS power dissipation.

The signal level applied to the D input is transferred to the Q output during the positive-going transition of the CLK pulse.

Battery Life vs. V_{CC} Supply Voltage

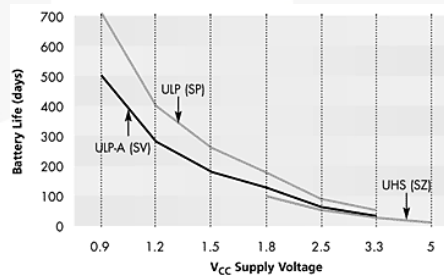

TinyLogic ULP and ULP-A with up to 50% less power consumption can extend your battery life significantly.

$$\text{Battery Life} = (V_{\text{battery}} * I_{\text{battery}} * .9) / (P_{\text{device}}) / 24\text{hrs/day}$$

$$\text{where: } P_{\text{device}} = (I_{CC} * V_{CC}) + (C_{PD} + C_L) * V_{CC}^2 * f$$

Assumes ideal 3.6V Lithium Ion battery with current rating of 900mAh and derated 90% and device frequency at 10MHz, with C_L = 15 pF load.

Ordering Information

Order Number	Package Number	Product Code Top Mark	Package Description	Supplied As
NC7SV74K8X	MAB08A	V74	8-Lead US8, JEDEC MO-187, Variation CA 3.1mm Wide	3k Units on Tape and Reel
NC7SV74L8X	MAC08A	Z4	Pb-Free 8-Lead MicroPak, 1.6 mm Wide	5k Units on Tape and Reel

Pb-Free package per JEDEC J-STD-020B.

Pin Descriptions

Pin Names	Description
D	Data Input
CK	Clock Pulse Input
CLR	Direct Clear Input
Q, \bar{Q}	Flip-Flop Output
PR	Direct Preset Input

Logic Symbol/s

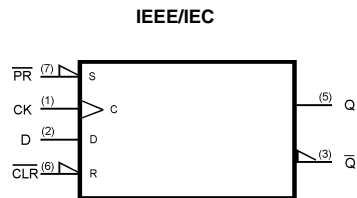

Truth Table/s

Inputs				Outputs		Function
CLR	PR	D	CK	Q	\bar{Q}	
L	H	X	X	L	H	Clear
H	L	X	X	H	L	Preset
L	L	X	X	H	H	—
H	H	L	-	L	H	—
H	H	H	-	H	L	—
H	H	X	-	Q_n	Q_n	No Change

H = HIGH Logic Level
 L = LOW Logic Level
 Q_n = No change in data
 X = Immaterial
 Z = High Impedance
 - = Rising Edge
 $\bar{\text{~}}$ = Falling edge

Connection Diagram/s

Pin Assignments for US8

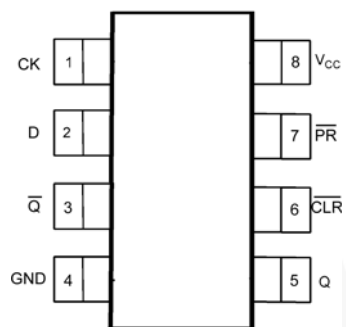

(Top View)

Pin One Orientation Diagram

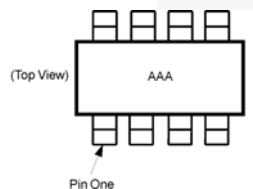

AAA represents Product Code Top Mark - see ordering info
Note: Orientation of Top Mark determines Pin One location. Read the top product code mark left to right, Pin One is the lower left pin (see diagram).

Pad Assignments for MicroPak

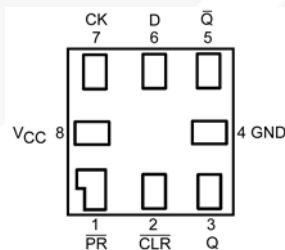

(Top Through View)

Absolute Maximum Ratings

Absolute Maximum Ratings: are those values beyond which the safety of the device cannot be guaranteed. The device should not be operated at these limits. The parametric values defined in the Electrical Characteristics tables are not guaranteed at the absolute maximum ratings. The "Recommended Operating Conditions" table will define the conditions for actual device operation. I_O Absolute Maximum Rating must be observed.

Supply Voltage (V_{CC})	-0.5V to +4.6V
DC Input Voltage (V_{IN})	-0.5V to +4.6V
DC Output Voltage (V_{OUT})	
HIGH or LOW State	-0.5V to $V_{CC} + 0.5V$
$V_{CC} = 0V$	-0.5V to +4.6V
DC Input Diode Current (I_{IK}) $V_{IN} < 0V$	±50 mA
DC Output Diode Current (I_{OK})	
$V_{OUT} < 0V$	-50 mA
$V_{OUT} > V_{CC}$	+50 mA
DC Output Source/Sink Current (I_{OH}/I_{OL})	± 50 mA
DC V_{CC} or Ground Current per	
Supply Pin (I_{CC} or Ground)	± 50 mA
Storage Temperature Range (T_{STG})	-65°C to +150°C

Recommended Operating Conditions

Unused inputs must be held HIGH or LOW. They may not float.

Power Supply	0.9V to 3.6V
Input Voltage (V_{IN})	0V to 3.6V
Output Voltage (V_{OUT})	
$V_{CC} = 0.0V$	0V to 3.6V
HIGH or LOW State	0V to V_{CC}
Output Current in I_{OH}/I_{OL}	
$V_{CC} = 3.0V$ to 3.6V	±24.0 mA
$V_{CC} = 2.3V$ to 2.7V	±18.0 mA
$V_{CC} = 1.65V$ to 1.95V	±6.0 mA
$V_{CC} = 1.4V$ to 1.6V	±4.0 mA
$V_{CC} = 1.1V$ to 1.3V	±2.0 mA
$V_{CC} = 0.9V$	±0.1 mA
Free Air Operating Temperature (T_A)	-40°C to +85°C
Minimum Input Edge Rate (dt/dv)	
$V_{IN} = 0.8V$ to 2.0V, $V_{CC} = 3.0V$	10 ns/V

DC Electrical Characteristics

Symbol	Parameter	V _{CC} (V)	T _A = +25°C		T _A = -40°C to +85°C		Units	Conditions
			Min.	Max.	Min.	Max.		
V _{IH}	HIGH Level Input Voltage	0.90	0.65 x V _{CC}		0.65 x V _{CC}		V	
		1.10 ≤ V _{CC} ≤ 1.30	0.65 x V _{CC}		0.65 x V _{CC}			
		1.40 ≤ V _{CC} ≤ 1.60	0.65 x V _{CC}		0.65 x V _{CC}			
		1.65 ≤ V _{CC} ≤ 1.95	0.65 x V _{CC}		0.65 x V _{CC}			
		2.30 ≤ V _{CC} ≤ 2.70	1.6		1.6			
V _{IL}	LOW Level Input Voltage	0.90	0.35 x V _{CC}		0.35 x V _{CC}		V	
		1.10 ≤ V _{CC} ≤ 1.30	0.35 x V _{CC}		0.35 x V _{CC}			
		1.40 ≤ V _{CC} ≤ 1.60	0.35 x V _{CC}		0.35 x V _{CC}			
		1.65 ≤ V _{CC} ≤ 1.95	0.35 x V _{CC}		0.35 x V _{CC}			
		2.30 ≤ V _{CC} ≤ 2.70	0.7		0.7			
V _{OH}	HIGH Level Output Voltage	0.90	V _{CC} - 0.1		V _{CC} - 0.1		V	I _{OH} = -100 mA
		1.10 ≤ V _{CC} ≤ 1.30	V _{CC} - 0.1		V _{CC} - 0.1			
		1.40 ≤ V _{CC} ≤ 1.60	V _{CC} - 0.2		V _{CC} - 0.2			
		1.65 ≤ V _{CC} ≤ 1.95	V _{CC} - 0.2		V _{CC} - 0.2			
		2.30 ≤ V _{CC} ≤ 2.70	V _{CC} - 0.2		V _{CC} - 0.2			
		2.70 ≤ V _{CC} ≤ 3.60	V _{CC} - 0.2		V _{CC} - 0.2			
		1.10 ≤ V _{CC} ≤ 1.30	0.75 x V _{CC}		0.75 x V _{CC}			
		1.40 ≤ V _{CC} ≤ 1.60	0.75 x V _{CC}		0.75 x V _{CC}			
		1.65 ≤ V _{CC} ≤ 1.95	1.25		1.25			
		2.30 ≤ V _{CC} ≤ 2.70	2.0		2.0			
		2.30 ≤ V _{CC} ≤ 2.70	1.8		1.8			
		2.70 ≤ V _{CC} ≤ 3.60	2.2		2.2			
		2.30 ≤ V _{CC} ≤ 2.70	1.7		1.7			
		2.70 ≤ V _{CC} ≤ 3.60	2.4		2.4			
2.70 ≤ V _{CC} ≤ 3.60	2.2		2.2					
V _{OL}	LOW Level Output Voltage	0.90	0.1		0.1		V	I _{OL} = 100 mA
		1.10 ≤ V _{CC} ≤ 1.30	0.1		0.1			
		1.40 ≤ V _{CC} ≤ 1.60	0.2		0.2			
		1.65 ≤ V _{CC} ≤ 1.95	0.2		0.2			
		2.30 ≤ V _{CC} ≤ 2.70	0.2		0.2			
		2.70 ≤ V _{CC} ≤ 3.60	0.2		0.2			
		1.10 ≤ V _{CC} ≤ 1.30	0.25 x V _{CC}		0.25 x V _{CC}			
		1.40 ≤ V _{CC} ≤ 1.60	0.25 x V _{CC}		0.25 x V _{CC}			
		1.65 ≤ V _{CC} ≤ 1.95	0.3		0.3			
		2.30 ≤ V _{CC} ≤ 2.70	0.4		0.4			
		2.70 ≤ V _{CC} ≤ 3.60	0.4		0.4			
		2.30 ≤ V _{CC} ≤ 2.70	0.6		0.6			
		2.70 ≤ V _{CC} ≤ 3.60	0.4		0.4			
		2.70 ≤ V _{CC} ≤ 3.60	0.55		0.55			
I _{IN}	Input Leakage Current	0.90 to 3.60	±0.1		±0.5		mA	0 ≤ V _I ≤ 3.6V
I _{OFF}	Power Off Leakage Current	0	0.5		0.5		mA	0 ≤ (V _I , V _O) ≤ 3.6V
I _{CC}	Quiescent Supply Current	0.90 to 3.60	0.9		0.9		mA	V _I = V _{CC} or GND V _{CC} ≤ V _I ≤ 3.6V
		0.90 to 3.60			±0.9			

AC Electrical Characteristics

Symbol	Parameter	V _{CC} (V)	T _A = +25°C			T _A = -40°C to +85°C		Units	Conditions	Figure Number
			Min.	Typ.	Max.	Min.	Max.			
f _{MAX}	Maximum Clock Frequency	0.90	50					MHz	C _L = 15 pF, R _L = 1 MΩ	Figure 1 Figure 5
		1.10 ≤ V _{CC} ≤ 1.30	150			150			C _L = 15 pF, R _L = 2 kΩ	
		1.40 ≤ V _{CC} ≤ 1.60	200			200			C _L = 30 pF, R _L = 500Ω	
		1.65 ≤ V _{CC} ≤ 1.95	200			200				
		2.30 ≤ V _{CC} ≤ 2.70	200			200				
2.70 ≤ V _{CC} ≤ 3.60	200			200						
t _{PLH}	Propagation Delay CK to Q, \bar{Q}	0.90	13.0					ns	C _L = 15 pF, R _L = 1 MΩ	Figure 1 Figure 3
t _{PHL}		1.10 ≤ V _{CC} ≤ 1.30	3.0	6.0	9.9	1.0	14.6		C _L = 15 pF, R _L = 2 kΩ	
		1.40 ≤ V _{CC} ≤ 1.60	1.0	3.2	6.0	1.0	7.2		C _L = 30 pF, R _L = 500 Ω	
		1.65 ≤ V _{CC} ≤ 1.95	1.0	1.9	4.5	1.0	5.3			
		2.30 ≤ V _{CC} ≤ 2.70	0.8	1.2	3.0	0.7	3.7			
2.70 ≤ V _{CC} ≤ 3.60	0.7	1.0	2.8	0.6	3.2					
t _{PLH}	Propagation Delay \overline{CLR} , \overline{PR} , to Q, \bar{Q}	0.90	14.0					ns	C _L = 15 pF, R _L = 1 MΩ	Figure 1 Figure 3
t _{PHL}		1.10 ≤ V _{CC} ≤ 1.30	3.0	6.5	10.5	1.0	15.1		C _L = 15 pF, R _L = 2 kΩ	
		1.40 ≤ V _{CC} ≤ 1.60	1.0	3.2	6.0	1.0	7.2		C _L = 30 pF, R _L = 500 Ω	
		1.65 ≤ V _{CC} ≤ 1.95	1.0	1.9	4.5	1.0	5.3			
		2.30 ≤ V _{CC} ≤ 2.70	0.8	1.2	3.0	0.7	3.7			
2.70 ≤ V _{CC} ≤ 3.60	0.7	1.0	2.8	0.6	3.2					
t _S	Setup Time, CK to D	0.90	6.5			6.5		ns	C _L = 15 pF, R _L = 1 MΩ	Figure 1 Figure 4
		1.10 ≤ V _{CC} ≤ 1.30	3.5				3.5		C _L = 15 pF, R _L = 2 kΩ	
		1.40 ≤ V _{CC} ≤ 1.60	2.0				2.0		C _L = 30 pF, R _L = 500 Ω	
		1.65 ≤ V _{CC} ≤ 1.95	1.5				1.5			
		2.30 ≤ V _{CC} ≤ 2.70	2.0				2.0			
2.70 ≤ V _{CC} ≤ 3.60	1.5				1.5					
t _H	Hold Time, CK to D	0.90	0.5			0.5		ns	C _L = 15 pF, R _L = 1 MΩ	Figure 1 Figure 4
		1.10 ≤ V _{CC} ≤ 1.30	0.5				0.5		C _L = 15 pF, R _L = 2 kΩ	
		1.40 ≤ V _{CC} ≤ 1.60	0.5				0.5		C _L = 30 pF, R _L = 500 Ω	
		1.65 ≤ V _{CC} ≤ 1.95	0.5				0.5			
		2.30 ≤ V _{CC} ≤ 2.70	0.5				0.5			
2.70 ≤ V _{CC} ≤ 3.60	0.5				0.5					
t _W	Pulse Width, CK, \overline{PR} , \overline{CLR}	0.90	7.0			7.0		ns	C _L = 15 pF, R _L = 1 MΩ	Figure 1 Figure 5
		1.10 ≤ V _{CC} ≤ 1.30	4.0				4.0		C _L = 15 pF, R _L = 2 kΩ	
		1.40 ≤ V _{CC} ≤ 1.60	3.0				3.0		C _L = 30 pF, R _L = 500Ω	
		1.65 ≤ V _{CC} ≤ 1.95	3.0				3.0			
		2.30 ≤ V _{CC} ≤ 2.70	3.0				3.0			
2.70 ≤ V _{CC} ≤ 3.60	3.0				3.0					
t _{REC}	Recover Time \overline{CLR} , \overline{PR} to CK	0.90	8.0			8.0		ns	C _L = 15 pF, R _L = 1 MΩ	Figure 1 Figure 4
		1.10 ≤ V _{CC} ≤ 1.30	4.5				4.5		C _L = 15 pF, R _L = 2 kΩ	
		1.40 ≤ V _{CC} ≤ 1.60	3.0				3.0		C _L = 30 pF, R _L = 500Ω	
		1.65 ≤ V _{CC} ≤ 1.95	3.0				3.0			
		2.30 ≤ V _{CC} ≤ 2.70	3.0				3.0			
2.70 ≤ V _{CC} ≤ 3.60	3.0				3.0					

Capacitance

Symbol	Parameter	Typ.	Max.	Units	Conditions
C _{IN}	Input Capacitance	2.0		pF	V _{CC} = 0V
C _{OUT}	Output Capacitance	4.5		pF	V _{CC} = 0V
C _{PD}	Power Dissipation Capacitance	20.0		pF	V _I = V _{CC} or 0V, f = 10 MHz

AC Loading and Waveforms

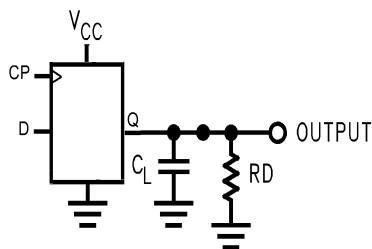

C_L includes load and stray capacitance

Input PRR = 1.0 MHz; $t_w = 500$ ns

AC Test Circuit

Test	Switch
t_{PLH} , t_{PHL}	Open
t_{PZL} , t_{PLZ}	6V at $V_{CC} = 3.3V \pm 0.3V$ $V_{CC} \times 2$ at $V_{CC} = < 3.0V$
t_{PZH} , t_{PHZ}	GND

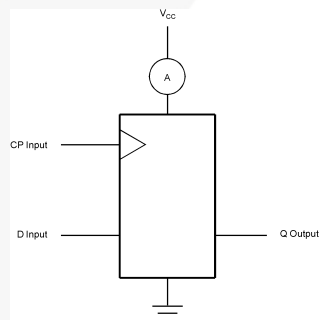

CP Input = AC Waveform; $t_r = t_f = 2.5$ ns;

CP Input PRR = 10 MHz; Duty Cycle = 50%

D Input PRR = 5MHz; Duty Cycle = 50%

I_{CCD} Test Circuit

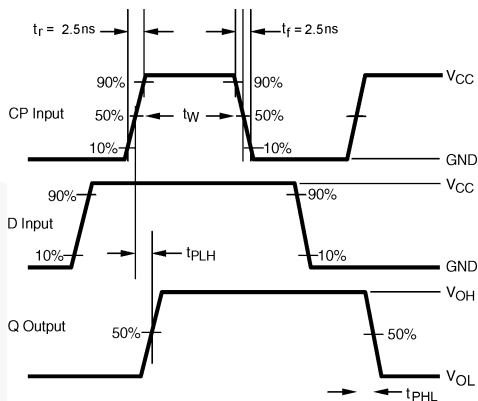

AC Waveforms

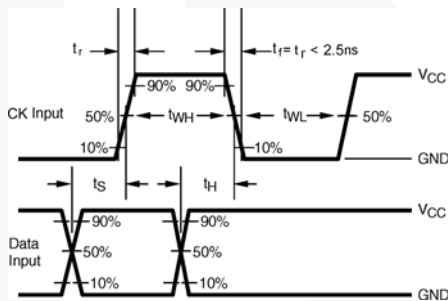

AC Waveforms

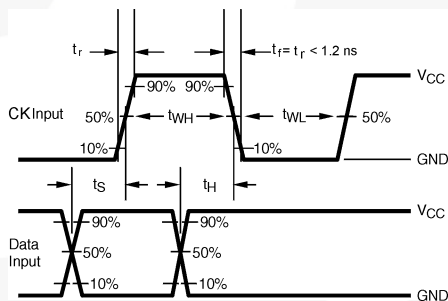

AC Waveforms

REEL DIMENSIONS inches (millimeters)

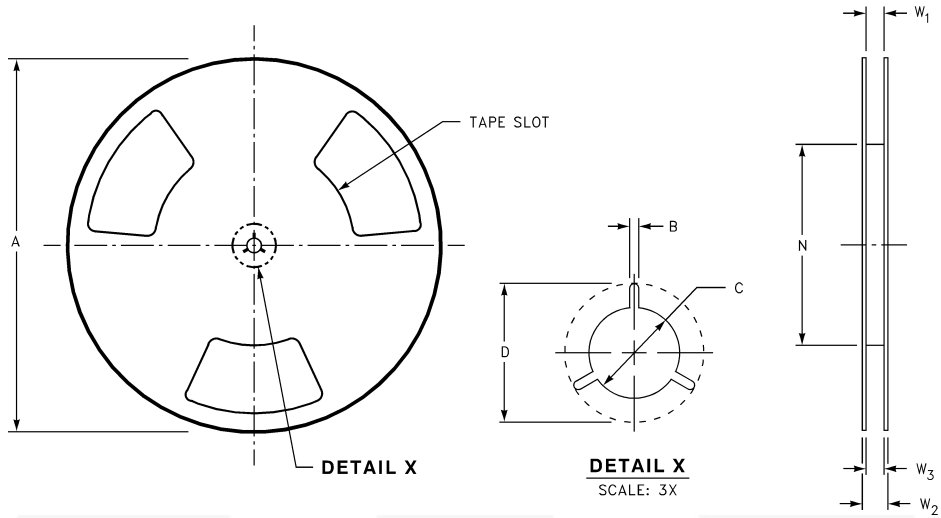

Tape Size	A	B	C	D	N	W1	W2	W3
8 mm	7.0 (177.8)	0.059 (1.50)	0.512 (13.00)	0.795 (20.20)	2.165 (55.00)	0.331 + 0.059/-0.000 (8.40 + 1.50/-0.00)	0.567 (14.40)	W1 + 0.078/-0.039 (W1 + 2.00/-1.00)

Physical Dimensions

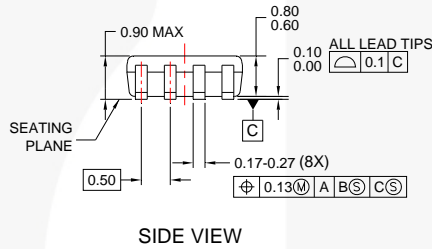
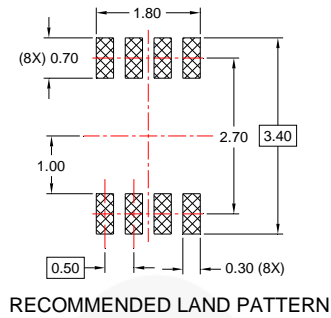
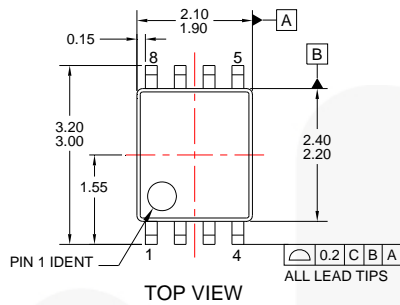

NOTES:

- A. CONFORMS TO JEDEC REGISTRATION MO-187
- B. DIMENSIONS ARE IN MILLIMETERS.
- C. DIMENSIONS ARE EXCLUSIVE OF BURRS, MOLD FLASH, AND TIE BAR EXTRUSIONS.
- D. DIMENSIONS AND TOLERANCES PER ANSI Y14.5M, 1994.
- E. FILE DRAWING NAME : MKT-MAB08Arev4

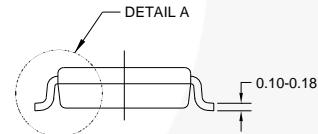
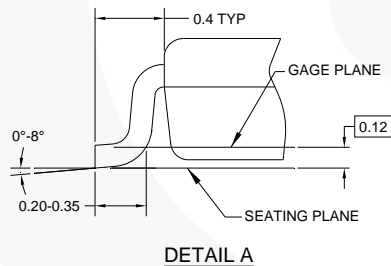

8-Lead US8, JEDEC MO-187, Variation CA 3.1mm Wide Package Number MAB08A

Package drawings are provided as a service to customers considering Fairchild components. Drawings may change in any manner without notice. Please note the revision and/or date on the drawing and contact a Fairchild Semiconductor representative to verify or obtain the most recent revision. Package specifications do not expand the terms of Fairchild's worldwide terms and conditions, specifically the warranty therein, which covers Fairchild products.

Always visit Fairchild Semiconductor's online packaging area for the most recent package drawings:
<http://www.fairchildsemi.com/dwg/MA/MAB08A.pdf>

Physical Dimensions

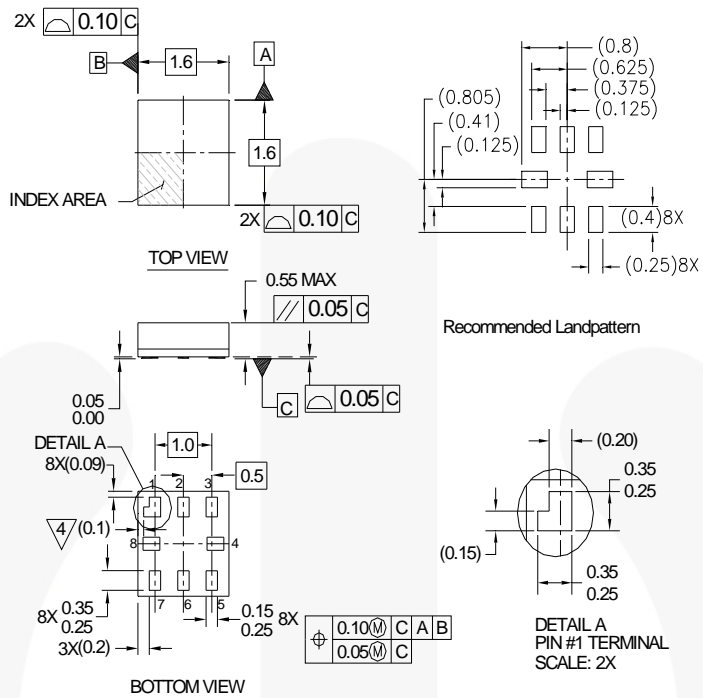

- Notes:
1. PACKAGE CONFORMS TO JEDEC MO-255 VARIATION UAAD
 2. DIMENSIONS ARE IN MILLIMETERS
 3. DRAWING CONFORMS TO ASME Y.14M-1994
 - 4/PIN 1 FLAG, END OF PACKAGE OFFSET
 5. DRAWING FILE NAME: MKT-MAC08AREV4

MAC08AREV4

**Pb-Free 8-Lead MicroPak, 1.6 mm Wide
Package Number MAC08A**

Package drawings are provided as a service to customers considering Fairchild components. Drawings may change in any manner without notice. Please note the revision and/or date on the drawing and contact a Fairchild Semiconductor representative to verify or obtain the most recent revision. Package specifications do not expand the terms of Fairchild's worldwide terms and conditions, specifically the warranty therein, which covers Fairchild products.

Always visit Fairchild Semiconductor's online packaging area for the most recent package drawings:
<http://www.fairchildsemi.com/dwg/MA/MAC08A.pdf>



TRADEMARKS

The following includes registered and unregistered trademarks and service marks, owned by Fairchild Semiconductor and/or its global subsidiaries, and is not intended to be an exhaustive list of all such trademarks.

- | | | | |
|---|--|---|---|
| AccuPower™ | F-PFS™ |  | Sync-Lock™ |
| AX-CAP®* | FRFET® | PowerTrench® | SYSTEM GENERAL® |
| BASIC™ | Global Power Resource™ | PowerXS™ | TinyBoost® |
| Build it Now™ | GreenBridge™ | Programmable Active Droop™ | TinyBuck® |
| CorePLUS™ | Green FPS™ | QFET® | TinyCalc™ |
| CorePOWER™ | Green FPS™ e-Series™ | QS™ | TinyLogic® |
| CROSSVOLT™ | Gmax™ | Quiet Series™ | TINYOPTO™ |
| CTL™ | GTO™ | RapidConfigure™ | TinyPower™ |
| Current Transfer Logic™ | IntelliMAX™ |  | TinyPWM™ |
| DEUXPEED® | ISOPLANAR™ | Saving our world, 1mW/WkW at a time™ | TinyWire™ |
| Dual Cool™ | Making Small Speakers Sound Louder and Better™ | SignalWise™ | TranSiC™ |
| EcoSPARK® | MegaBuck™ | SmartMax™ | TriFault Detect™ |
| EfficientMax™ | MICROCOUPLER™ | SMART START™ | TRUECURRENT®* |
| ESBC™ | MicroFET™ | Solutions for Your Success™ | µSerDes™ |
|  | MicroPak™ | SPM® |  |
| Fairchild® | MicroPak2™ | STEALTH™ | UHC® |
| Fairchild Semiconductor® | MillerDrive™ | SuperFET™ | Ultra FRFET™ |
| FACT Quiet Series™ | MotionMax™ | SuperSOT™-3 | UniFET™ |
| FACT® | mWSaver® | SuperSOT™-6 | VCX™ |
| FAST® | OptoHi™ | SuperSOT™-8 | VisualMax™ |
| FastvCore™ | OPTOLOGIC® | SupreMOS® | VoltagePlus™ |
| FETBench™ | OPTOPLANAR® | SyncFET™ | XS™ |
| FPS™ | | | |

* Trademarks of System General Corporation, used under license by Fairchild Semiconductor.

DISCLAIMER

FAIRCHILD SEMICONDUCTOR RESERVES THE RIGHT TO MAKE CHANGES WITHOUT FURTHER NOTICE TO ANY PRODUCTS HEREIN TO IMPROVE RELIABILITY, FUNCTION, OR DESIGN. FAIRCHILD DOES NOT ASSUME ANY LIABILITY ARISING OUT OF THE APPLICATION OR USE OF ANY PRODUCT OR CIRCUIT DESCRIBED HEREIN; NEITHER DOES IT CONVEY ANY LICENSE UNDER ITS PATENT RIGHTS, NOR THE RIGHTS OF OTHERS. THESE SPECIFICATIONS DO NOT EXPAND THE TERMS OF FAIRCHILD'S WORLDWIDE TERMS AND CONDITIONS, SPECIFICALLY THE WARRANTY THEREIN, WHICH COVERS THESE PRODUCTS.

LIFE SUPPORT POLICY

FAIRCHILD'S PRODUCTS ARE NOT AUTHORIZED FOR USE AS CRITICAL COMPONENTS IN LIFE SUPPORT DEVICES OR SYSTEMS WITHOUT THE EXPRESS WRITTEN APPROVAL OF FAIRCHILD SEMICONDUCTOR CORPORATION.

As used herein:

1. Life support devices or systems are devices or systems which, (a) are intended for surgical implant into the body or (b) support or sustain life, and (c) whose failure to perform when properly used in accordance with instructions for use provided in the labeling, can be reasonably expected to result in a significant injury of the user.
2. A critical component in any component of a life support, device, or system whose failure to perform can be reasonably expected to cause the failure of the life support device or system, or to affect its safety or effectiveness.

ANTI-COUNTERFEITING POLICY

Fairchild Semiconductor Corporation's Anti-Counterfeiting Policy. Fairchild's Anti-Counterfeiting Policy is also stated on our external website, www.fairchildsemi.com, under Sales Support.

Counterfeiting of semiconductor parts is a growing problem in the industry. All manufacturers of semiconductor products are experiencing counterfeiting of their parts. Customers who inadvertently purchase counterfeit parts experience many problems such as loss of brand reputation, substandard performance, failed applications, and increased cost of production and manufacturing delays. Fairchild is taking strong measures to protect ourselves and our customers from the proliferation of counterfeit parts. Fairchild strongly encourages customers to purchase Fairchild parts either directly from Fairchild or from Authorized Fairchild Distributors who are listed by country on our web page cited above. Products customers buy either from Fairchild directly or from Authorized Fairchild Distributors are genuine parts, have full traceability, meet Fairchild's quality standards for handling and storage and provide access to Fairchild's full range of up-to-date technical and product information. Fairchild and our Authorized Distributors will stand behind all warranties and will appropriately address any warranty issues that may arise. Fairchild will not provide any warranty coverage or other assistance for parts bought from Unauthorized Sources. Fairchild is committed to combat this global problem and encourage our customers to do their part in stopping this practice by buying direct or from authorized distributors.

PRODUCT STATUS DEFINITIONS

Definition of Terms

Datasheet Identification	Product Status	Definition
Advance Information	Formative / In Design	Datasheet contains the design specifications for product development. Specifications may change in any manner without notice.
Preliminary	First Production	Datasheet contains preliminary data; supplementary data will be published at a later date. Fairchild Semiconductor reserves the right to make changes at any time without notice to improve design.
No Identification Needed	Full Production	Datasheet contains final specifications. Fairchild Semiconductor reserves the right to make changes at any time without notice to improve the design.
Obsolete	Not In Production	Datasheet contains specifications on a product that is discontinued by Fairchild Semiconductor. The datasheet is for reference information only.

Rev. I66

ON Semiconductor and  are trademarks of Semiconductor Components Industries, LLC dba ON Semiconductor or its subsidiaries in the United States and/or other countries. ON Semiconductor owns the rights to a number of patents, trademarks, copyrights, trade secrets, and other intellectual property. A listing of ON Semiconductor's product/patent coverage may be accessed at www.onsemi.com/site/pdf/Patent-Marking.pdf. ON Semiconductor reserves the right to make changes without further notice to any products herein. ON Semiconductor makes no warranty, representation or guarantee regarding the suitability of its products for any particular purpose, nor does ON Semiconductor assume any liability arising out of the application or use of any product or circuit, and specifically disclaims any and all liability, including without limitation special, consequential or incidental damages. Buyer is responsible for its products and applications using ON Semiconductor products, including compliance with all laws, regulations and safety requirements or standards, regardless of any support or applications information provided by ON Semiconductor. "Typical" parameters which may be provided in ON Semiconductor data sheets and/or specifications can and do vary in different applications and actual performance may vary over time. All operating parameters, including "Typicals" must be validated for each customer application by customer's technical experts. ON Semiconductor does not convey any license under its patent rights nor the rights of others. ON Semiconductor products are not designed, intended, or authorized for use as a critical component in life support systems or any FDA Class 3 medical devices or medical devices with a same or similar classification in a foreign jurisdiction or any devices intended for implantation in the human body. Should Buyer purchase or use ON Semiconductor products for any such unintended or unauthorized application, Buyer shall indemnify and hold ON Semiconductor and its officers, employees, subsidiaries, affiliates, and distributors harmless against all claims, costs, damages, and expenses, and reasonable attorney fees arising out of, directly or indirectly, any claim of personal injury or death associated with such unintended or unauthorized use, even if such claim alleges that ON Semiconductor was negligent regarding the design or manufacture of the part. ON Semiconductor is an Equal Opportunity/Affirmative Action Employer. This literature is subject to all applicable copyright laws and is not for resale in any manner.

PUBLICATION ORDERING INFORMATION

LITERATURE FULFILLMENT:

Literature Distribution Center for ON Semiconductor
19521 E. 32nd Pkwy, Aurora, Colorado 80011 USA
Phone: 303-675-2175 or 800-344-3860 Toll Free USA/Canada
Fax: 303-675-2176 or 800-344-3867 Toll Free USA/Canada
Email: orderlit@onsemi.com

N. American Technical Support: 800-282-9855 Toll Free
USA/Canada
Europe, Middle East and Africa Technical Support:
Phone: 421 33 790 2910
Japan Customer Focus Center
Phone: 81-3-5817-1050

ON Semiconductor Website: www.onsemi.com
Order Literature: <http://www.onsemi.com/orderlit>
For additional information, please contact your local
Sales Representative