

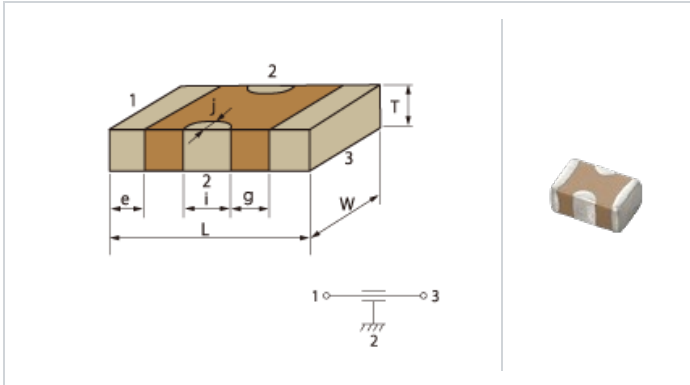

< List of part numbers with package codes >
NFM41CC102R2A3L

Shape



L size	4.5 ±0.3mm
W size	1.6 ±0.3mm
T size	1.0 ±0.2mm
External terminal width e	0.4±0.3mm
External terminal size i	1.5±0.3mm
External terminal size j	0.3+0.3/-0.2mm
Distance between external terminals g	0.8mm min.
Size code in inch(mm)	1806 (4516M)

References

Packaging	Specifications	Minimum quantity
L	φ180mm Embossed taping	4000

Mass (typ.)	
1 piece	38mg
φ180mm Reel	250g

Specifications

Capacitance	1000pF +50/-20%
Rated voltage	100Vdc
Operating temperature range	-55 to 125°C
Rated Current	300mA
DC Resistance(max.)	300mΩ

Attention

- 1.This datasheet is downloaded from the website of Murata Manufacturing Co., Ltd. Therefore, it's specifications are subject to change or our products in it may be discontinued without advance notice. Please check with our sales representatives or product engineers before ordering.
- 2.This datasheet has only typical specifications because there is no space for detailed specifications. Therefore, please review our product specifications or consult the approval sheet for product specifications before ordering.