

SINGLE 10-A OUTPUT, 4.75-V to 14-V INPUT, NON-ISOLATED, DIGITAL POWERTRAIN™ MODULE

Check for Samples: [PTD08A210W](#)

FEATURES

- **Single 10-A Output**
- **4.75-V to 14-V Input Voltage**
- **Programmable Wide-Output Voltage (0.7 V to 3.6 V)**
- **Efficiencies up to 96%**
- **Digital I/O**
 - PWM signal
 - Fault Flag (FF)
 - Synchronous Rectifier Enable (SRE)
- **Analog I/O**
 - Temperature
 - Output current
- **Safety Agency Approvals:**
 - UL/IEC/CSA-C22.2 60950-1
- **Operating Temperature: –40°C to 85°C**

APPLICATIONS

- **Digital Power Systems using UCD9XXX Digital Controllers**

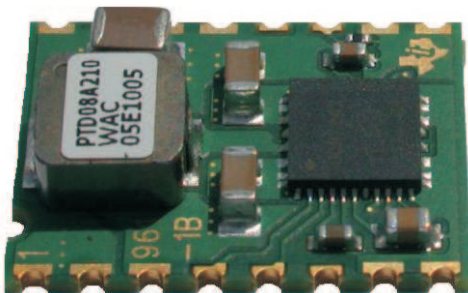

DESCRIPTION

The PTD08A210W is a high-performance single 10-A output, non-isolated digital PowerTrain module. This module is the power conversion section of a digital power system which incorporates TI's UCD7242 MOSFET/driver IC. The PTD08A210W must be used in conjunction with a digital power controller such as the UCD9240, UCD9220 or UCD9110 family. The PTD08A210W receives control signals from the digital controller and provides parametric and status information back to the digital controller. Together, PowerTrain modules and a digital power controller form a sophisticated, robust, and easily configured power management solution.

Operating from an input voltage range of 4.75 V to 14 V, the PTD08A210W provides step-down power conversion to a wide range of output voltages from, 0.7 V to 3.6 V. The wide input voltage range makes the PTD08A210W particularly suitable for advanced computing and server applications that utilize a loosely regulated 8-V, 9.6-V or 12-V intermediate distribution bus. Additionally, the wide input voltage range increases design flexibility by supporting operation with tightly regulated 5-V or 12-V intermediate bus architectures.

The module incorporates output over-current and temperature monitoring which protects against most load faults. Output current and module temperature signals are provided for the digital controller to permit user defined over-current and over-temperature warning and fault scenarios.

The module uses single-sided, pin-less surface mount construction to provide a low profile and compact footprint. The package is lead (Pb) - free and RoHS compatible.



Please be aware that an important notice concerning availability, standard warranty, and use in critical applications of Texas Instruments semiconductor products and disclaimers thereto appears at the end of this data sheet.

POWERTRAIN is a trademark of Texas Instruments.

PRODUCTION DATA information is current as of publication date. Products conform to specifications per the terms of the Texas Instruments standard warranty. Production processing does not necessarily include testing of all parameters.

Copyright © 2010, Texas Instruments Incorporated



This integrated circuit can be damaged by ESD. Texas Instruments recommends that all integrated circuits be handled with appropriate precautions. Failure to observe proper handling and installation procedures can cause damage.

ESD damage can range from subtle performance degradation to complete device failure. Precision integrated circuits may be more susceptible to damage because very small parametric changes could cause the device not to meet its published specifications.

Standard PTD08A210W Application

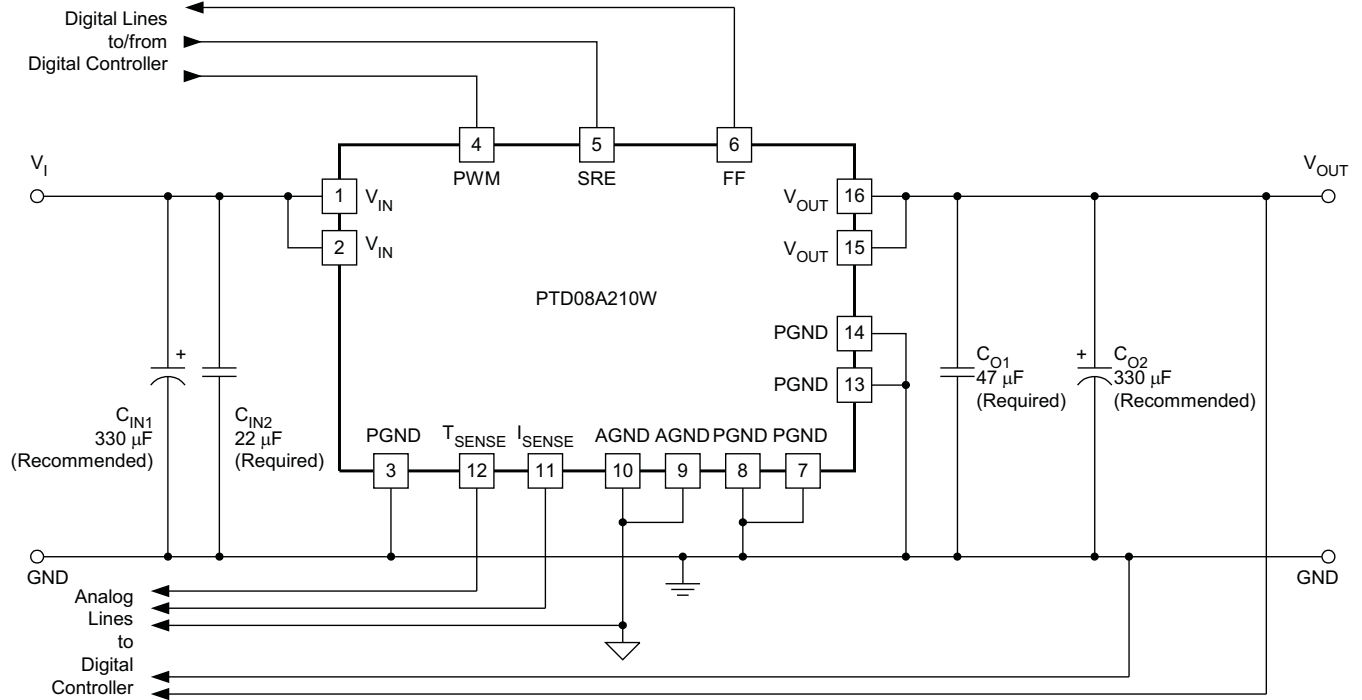

UDG-10063

ORDERING INFORMATION

For the most current package and ordering information, see the Package Option Addendum at the end of this datasheet, or see the TI website at www.ti.com.

DATASHEET TABLE OF CONTENTS

DATASHEET SECTION	PAGE NUMBER
ENVIRONMENTAL AND ABSOLUTE MAXIMUM RATINGS	3
ELECTRICAL CHARACTERISTICS TABLE	4
TERMINAL FUNCTIONS	5
TYPICAL CHARACTERISTICS ($V_I = 12V$)	6
TYPICAL CHARACTERISTICS ($V_I = 5V$)	7
TYPICAL APPLICATION SCHEMATIC	9
GRAPHICAL USER INTERFACE VALUES	10
TAPE & REEL AND TRAY DRAWINGS	11

ENVIRONMENTAL AND ABSOLUTE MAXIMUM RATINGS

(Voltages are with respect to GND)

			UNIT
V_I	Input voltage		16 V
T_A	Operating temperature range	Over V_I range	-40 to 85
T_{reflow}	Solder reflow temperature	Surface temperature of module body	260 ⁽¹⁾
T_{stg}	Storage temperature		-55 to 125
	Mechanical shock	Per Mil-STD-883D, Method 2002.3, 1 msec, 1/2 sine, mounted	275
	Mechanical vibration	Mil-STD-883D, Method 2007.2, 20-2000 Hz	10
	Weight		3.9 grams
MTBF	Reliability	Per Telcordia SR-332, 50% stress, $T_A = 40^\circ\text{C}$, ground benign	13.3 10^6 Hr
	Flammability	Meets UL94V-O	

(1) During reflow do not elevate peak temperature of the module or internal components above the stated maximum.

ELECTRICAL CHARACTERISTICS

PTD08A210W

$T_A = 25^\circ\text{C}$, $F_{\text{SW}} = 750\text{kHz}$, $V_I = 12\text{V}$, $V_O = 1.2\text{V}$, $C_{\text{IN}1} = 330\ \mu\text{F}$, $C_{\text{IN}2} = 22\ \mu\text{F}$ ceramic, $C_{\text{O}1} = 47\ \mu\text{F}$ ceramic, $C_{\text{O}2} = 330\ \mu\text{F}$, $I_O = I_{\text{O(max)}}$ (unless otherwise stated)

PARAMETER		TEST CONDITIONS		PTD08A210W			UNIT
				MIN	TYP	MAX	
I_O	Output current	Over V_O range	25°C, natural convection		0	10	A
V_I	Input voltage range	Over I_O range		4.75	14	V	
V_{OAdj}	Output voltage adjust range	Over I_O range		0.7	3.6 ⁽¹⁾	V	
η	Efficiency	$I_O = 10\text{A}$, $f_s = 750\text{kHz}$	$V_O = 3.3\text{V}$	92.0%			
			$V_O = 2.5\text{V}$	90.4%			
			$V_O = 1.8\text{V}$	88.4%			
			$V_O = 1.2\text{V}$	84.7%			
			$V_O = 0.8\text{V}$	80.0%			
V_{OPP}	V_O Ripple (peak-to-peak)	20-MHz bandwidth		11		mV _{PP}	
I_B	Bias current	PWM & SRE to AGND	Standby	6		mA	
V_{IH}	High-level input voltage	SRE & PWM input levels		2.0	5.5	V	
V_{IL}	Low-level input voltage			0.8			
	PWM input	Frequency range		500 ⁽¹⁾	1000	kHz	
		Pulse width limits		20		ns	
	TEMP output	Range		-40	125	°C	
		Accuracy, $-40^\circ\text{C} \leq T_A \leq 85^\circ\text{C}$		-5	5	°C	
		Slope		10		mV/°C	
		Offset, $T_A = 25^\circ\text{C}$		720		mV	
V_{OH}	FAULT output	High-level output voltage, $I_{\text{FAULT}} = 4\text{mA}$		2.7	3.3	V	
V_{OL}		Low-level output voltage, $I_{\text{FAULT}} = 4\text{mA}$		0	0.6		
I_{LIM}		Overcurrent threshold; Reset, followed by auto-recovery		15 ⁽²⁾		A	
	IOUT output	Range		0.15	3.5	V	
		Gain, $3\text{A} \leq I_O \leq 10\text{A}$		188	200	212	mV/A
		Offset, $I_O = 0\text{A}$, $V_O = 1.2\text{V}$		0	0.3	0.6	V
		Output Impedance		10		k Ω	
C_I	External input capacitance	Nonceramic		330 ⁽³⁾		μF	
		Ceramic		22 ⁽³⁾			
C_O	External output capacitance	Capacitance Value	Nonceramic	330 ⁽⁴⁾	5000 ⁽⁵⁾	μF	
			Ceramic	47 ⁽⁴⁾			
		Equivalent series resistance (non-ceramic)		1 ⁽⁶⁾		m Ω	

- When operating at 12V input and 500kHz, V_O is limited to $\leq 2.0\text{V}$.
- The current limit threshold is the sum of I_O and the peak inductor ripple current.
- A 22 μF ceramic input capacitor is required for proper operation. An additional 330 μF bulk capacitor rated for a minimum of 500mA rms of ripple current is recommended. When operating at frequencies > 500kHz the 22 μF ceramic capacitor is only recommended. Refer to the UCD9240 controller datasheet and user interface for application specific capacitor specifications.
- A 47 μF ceramic output capacitor is required for basic operation. An additional 330 μF bulk capacitor is recommended for improved transient response. Refer to the UCD9240 controller datasheet and user interface for application specific capacitor specifications.
- 5,000 μF is the calculated maximum output capacitance given a 1V/msec output voltage rise time. Additional capacitance or increasing the output voltage rise rate may trigger the overcurrent threshold at start-up. Refer to the UCD9240 controller datasheet and user interface for application specific capacitor specifications.
- This is the minimum ESR for all non-ceramic output capacitance. Refer to the UCD9240 controller datasheet and user interface for application specific capacitor specifications.

TERMINAL FUNCTIONS

TERMINAL		DESCRIPTION
NAME	NO.	
V _{IN}	1, 2	The positive input voltage power node to the module, which is referenced to common GND.
PGND	3, 7, 8, 13, 14	The common ground connection for the V _I and V _O power connections.
V _{OUT}	15, 16	The regulated positive power output with respect to GND.
I _{SENSE}	11	Current sense output. The voltage level on this pin represents the average output current of the module.
PWM	4	The PWM input pin. It is a high impedance digital input that accepts 3.3-V or 5-V logic level signals up to 1 MHz.
FF	6	Current limit fault flag. The Fault signal is a 3.3-V digital output which is latched high after an over-current condition. The Fault is reset after a complete PWM cycle without an over-current condition (falling edge of the PWM).
SRE	5	Synchronous Rectifier Enable. This pin is a high impedance digital input. A 3.3 V or 5 V logic level signals is used to enable the synchronous rectifier switch. When this signal is high, the module will source and sink output current. When this signal is low, the module will only source current.
AGND	9, 10	Analog ground return. It is the 0 V _{dc} reference for the control inputs.
T _{SENSE}	12	Temperature sense output. The voltage level on this pin represents the temperature of the module.
Thermal Pad		This pad is electrically connected to PGND and is the primary thermal conduction cooling path for the module. This pad should be soldered to a grounded copper pad on the host board. For optimum cooling performance, the grounded copper pad should also be tied with multiple vias to the host board internal ground plane. See the Land Pattern drawing for package ECY for recommended pad dimensions.

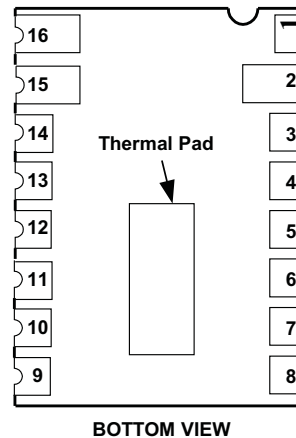
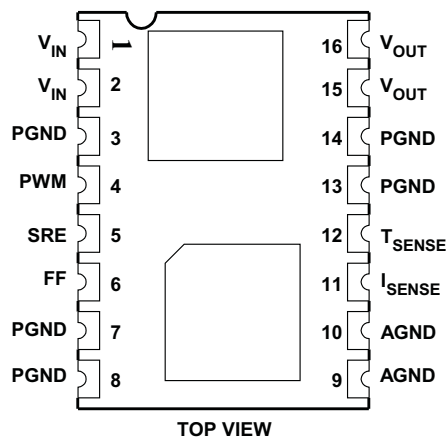

TYPICAL CHARACTERISTICS ($V_I = 12\text{ V}$)

(1)(2)

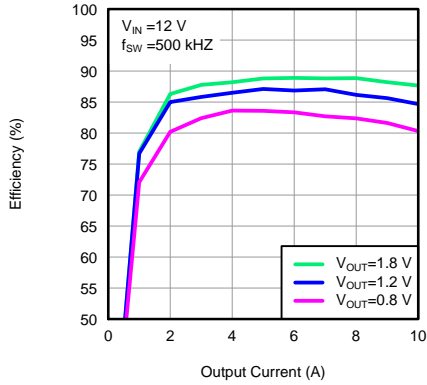

Figure 1. Efficiency

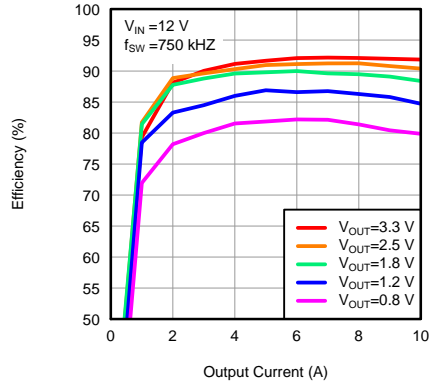

Figure 2. Efficiency

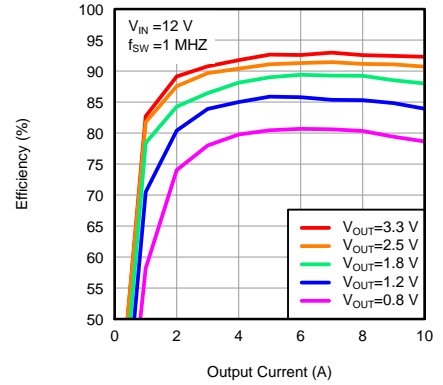

Figure 3. Efficiency

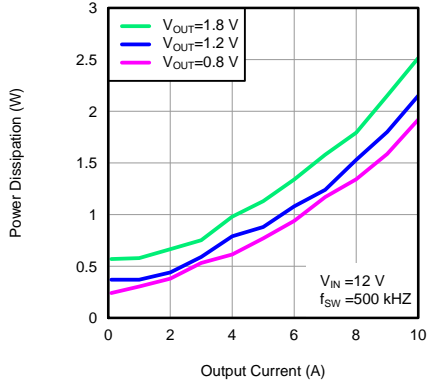

Figure 4. Power Dissipation

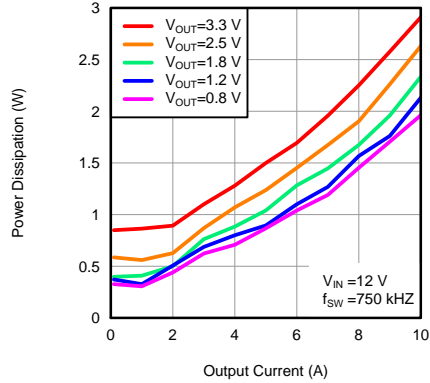

Figure 5. Power Dissipation

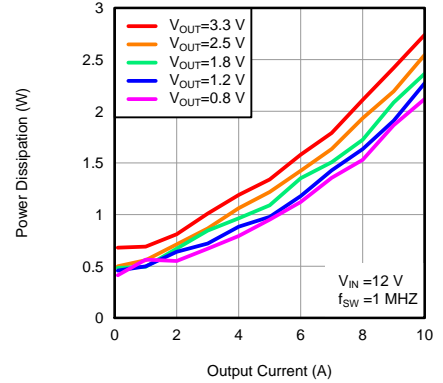

Figure 6. Power Dissipation

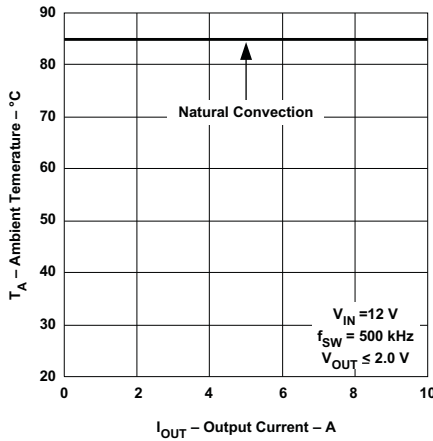

Figure 7. Safe Operating Area

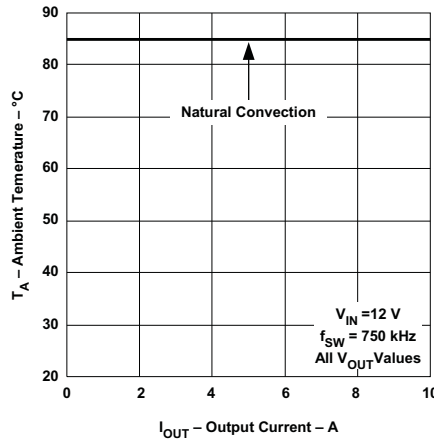

Figure 8. Safe Operating Area

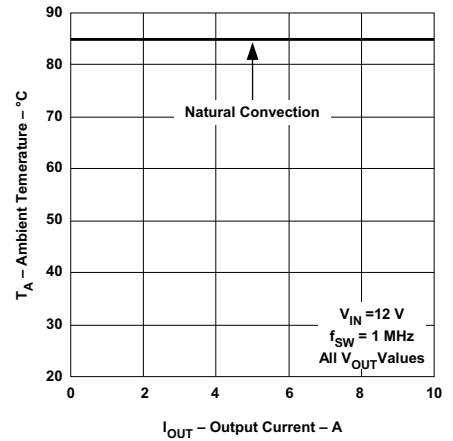

Figure 9. Safe Operating Area

- (1) The electrical characteristic data (Figure 1 through Figure 6) has been developed from actual products tested at 25°C. This data is considered typical for the converter.
- (2) The temperature derating curves (Figure 7 through Figure 9) represent the conditions at which internal components are at or below the manufacturer's maximum operating temperatures. Derating limits apply to modules soldered directly to a 100-mm x 100-mm, double-sided PCB with 2-oz. copper. See the Safe Operating Area application section of this datasheet.

TYPICAL CHARACTERISTICS ($V_I = 5\text{ V}$)
(1)(2)

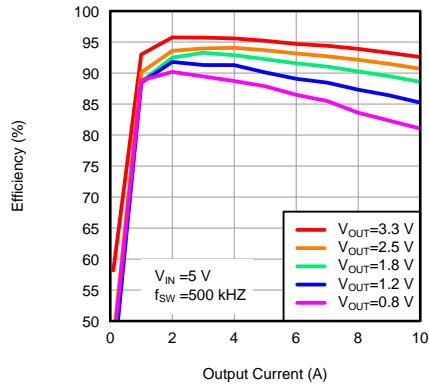

Figure 10. Efficiency

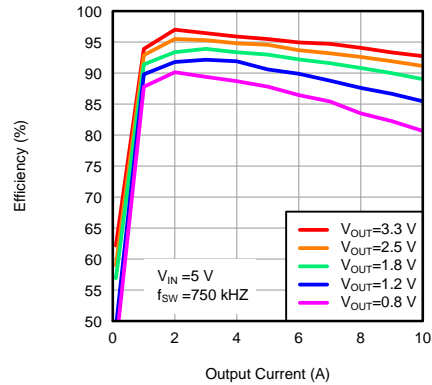

Figure 11. Efficiency

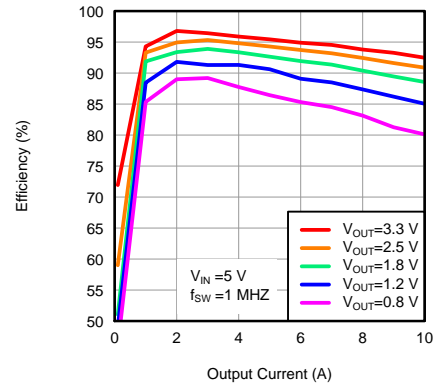

Figure 12. Efficiency

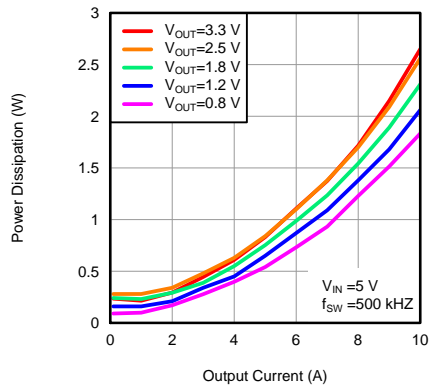

Figure 13. Power Dissipation

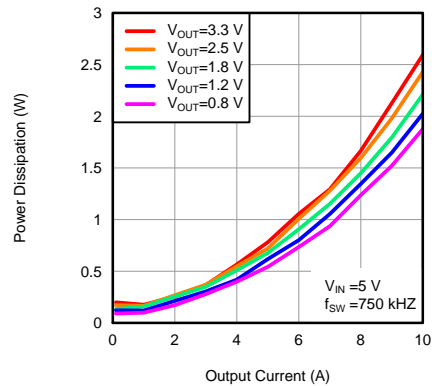

Figure 14. Power Dissipation

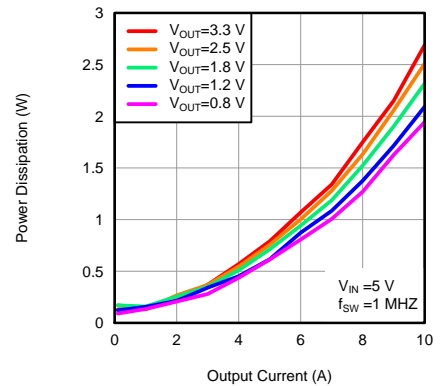

Figure 15. Power Dissipation

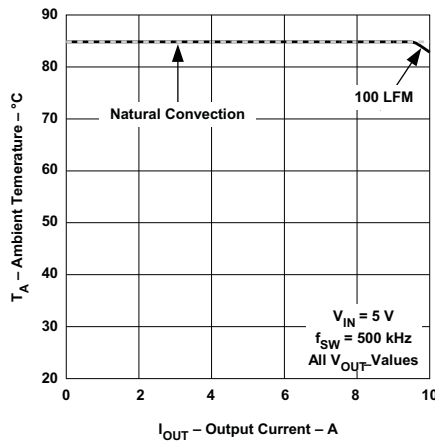

Figure 16. Safe Operating Area

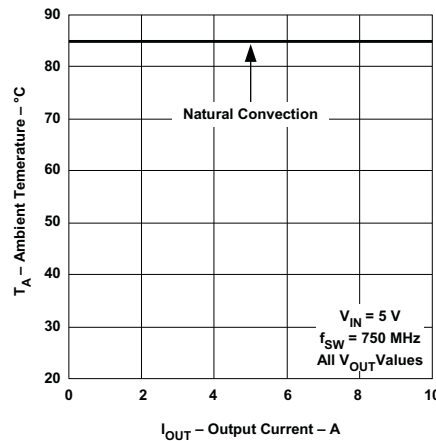

Figure 17. Safe Operating Area

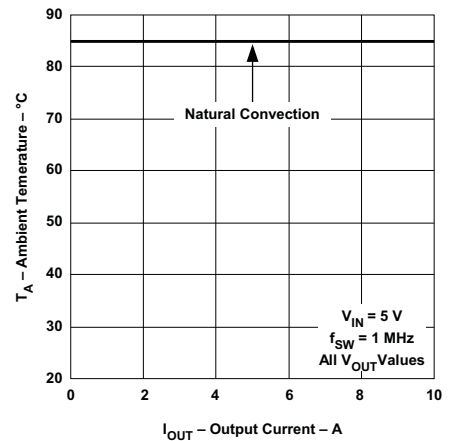

Figure 18. Safe Operating Area

- (1) The electrical characteristic data (Figure 10 through Figure 15) has been developed from actual products tested at 25°C. This data is considered typical for the converter.
- (2) The temperature derating curves (Figure 16 through Figure 18) represent the conditions at which internal components are at or below the manufacturer's maximum operating temperatures. Derating limits apply to modules soldered directly to a 100-mm x 100-mm, double-sided PCB with 2-oz. copper. See the Safe Operating Area application section of this datasheet.

TYPICAL CHARACTERISTICS

CURRENT SENSE OUTPUT
VS
OUTPUT CURRENT

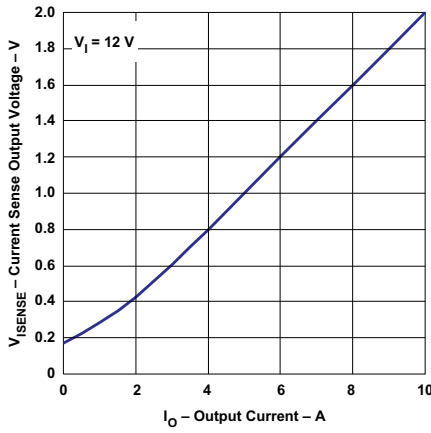

Figure 19.

CURRENT SENSE OUTPUT
VS
OUTPUT CURRENT

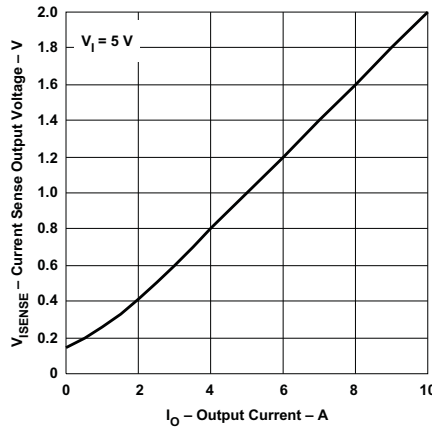

Figure 20.

TEMPERATURE SENSE
VS
JUNCTION TEMPERATURE

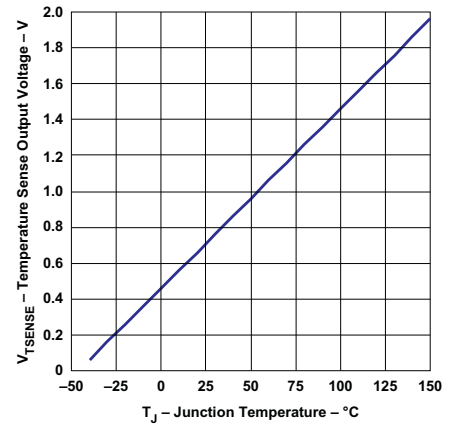

Figure 21.

APPLICATION INFORMATION

Digital Power

Figure 22 shows the UCD9220 power supply controller working with a single PTD08A210W, digital powertrain module. The loop for the power supply is created by the voltage output feeding into the Error ADC differential inputs, and completed by the DPWM output feeding the PTD08A210W module. A second stand-alone power stage can be controlled by the UCD9220 controller. The PTD08A210W's output cannot be paralleled. It can only be used as a single stand-alone 10-A module.

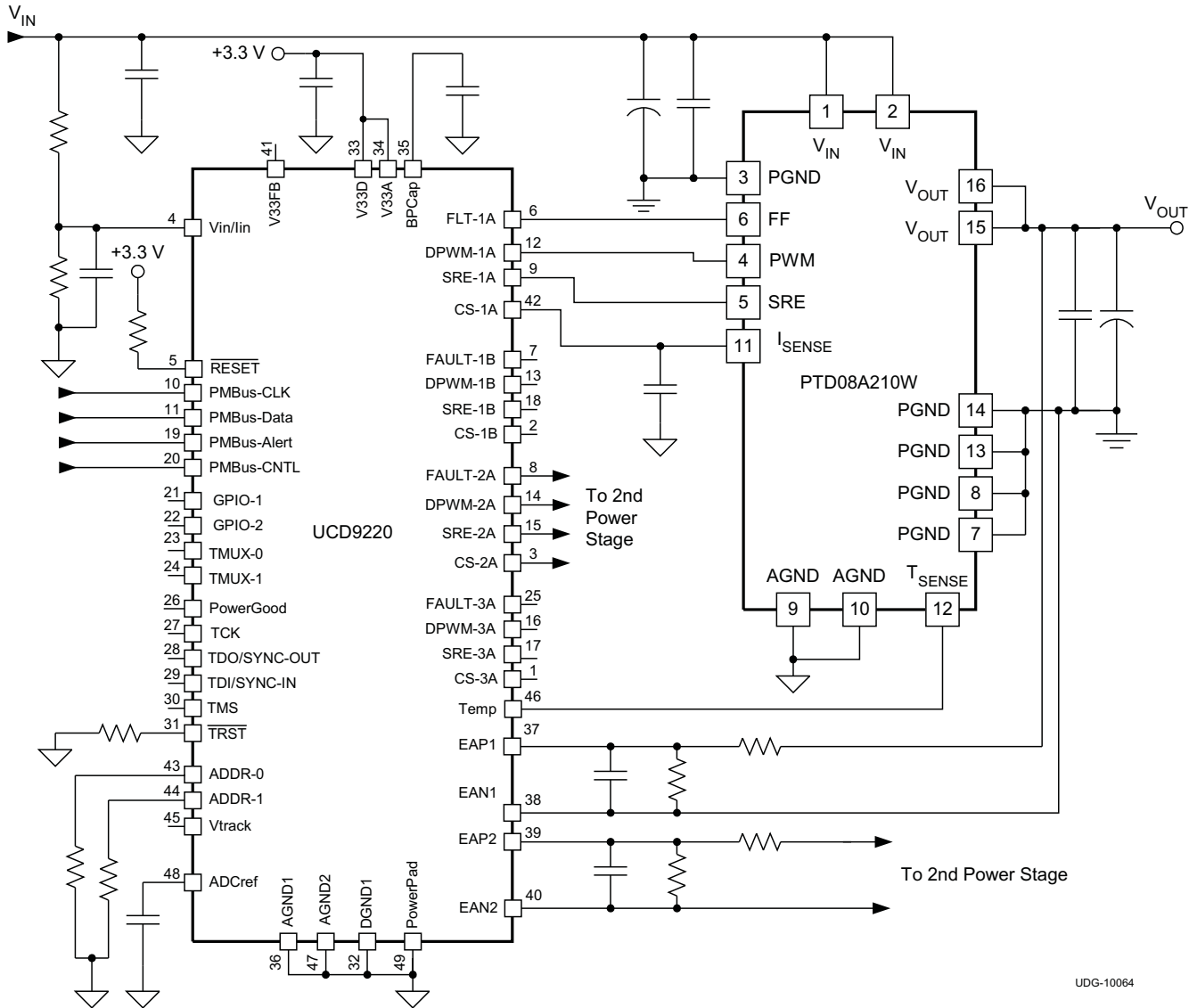

Figure 22. Typical Dual-Output Application Schematic

Note: A low dropout linear regulator such as the TI TPS715A33 can provide the 3.3-V bias power to the UCD9220.

Fusion Digital Power Graphical User Interface (GUI)

When using the UCD92x0 digital controller along with digital PowerTrain modules to design a digital power system, several internal parameters of the modules are required to run the Fusion Digital Power Designer GUI. See the plant parameters below for the PTD08A210W digital PowerTrain modules.

Table 1. PTD08A210W Plant Parameters

PTD08A210W Plant Parameters			
L (μH)	DCR ($\text{m}\Omega$)	$R_{\text{DS(on)}}$ -high ($\text{m}\Omega$)	$R_{\text{DS(on)}}$ -low ($\text{m}\Omega$)
0.47	2.6	15.5	6.5

Internal output capacitance is present on the digital PowerTrain modules themselves. When using the GUI interface this capacitance information must be included along with any additional external capacitance. See the capacitor parameters below for the PTD08A210W digital PowerTrain modules.

Table 2. PTD08A210W Capacitor Parameters

PTD08A210W Capacitor Parameters			
C (μF)	ESR ($\text{m}\Omega$)	ESL (nH)	Quantity
47	1.5	2.5	1

TAPE & REEL

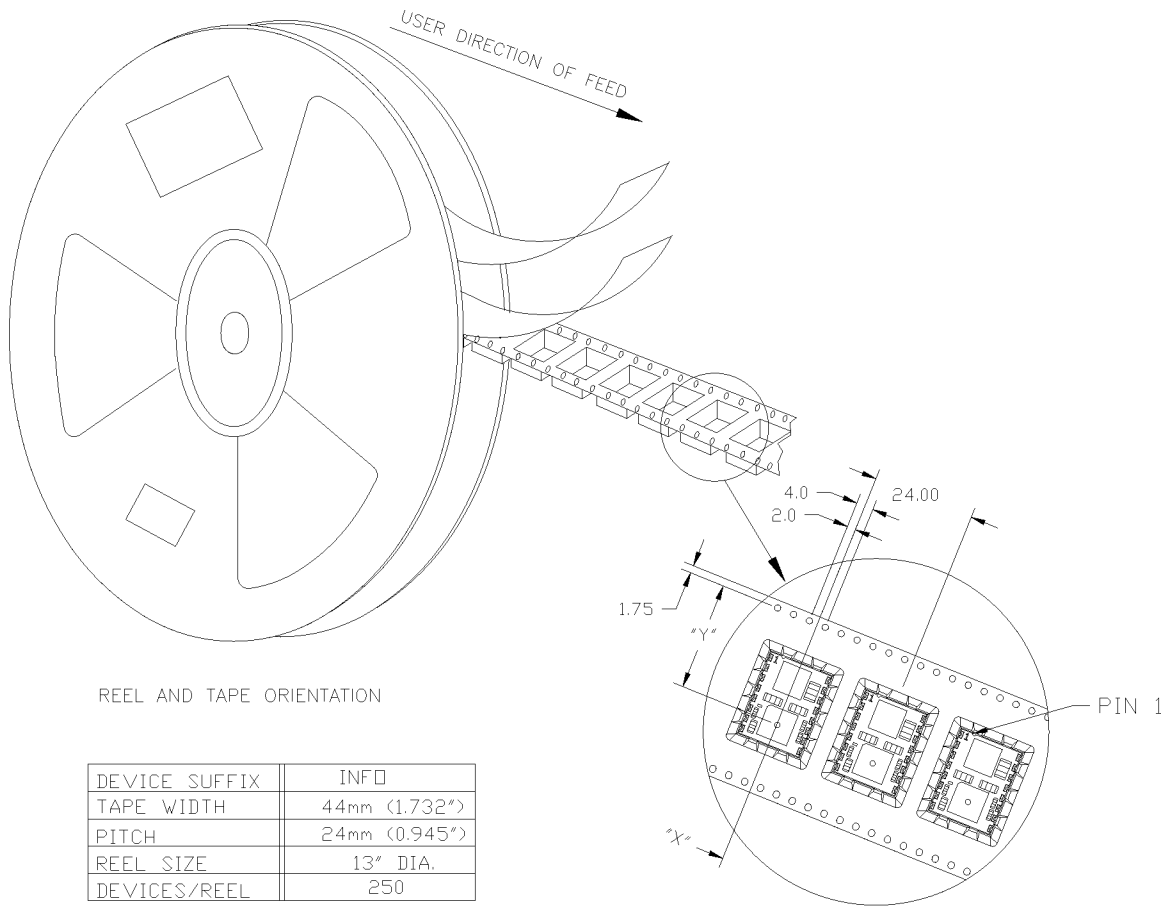

REEL AND TAPE ORIENTATION

DEVICE SUFFIX	INFO
TAPE WIDTH	44mm (1.732")
PITCH	24mm (0.945")
REEL SIZE	13" DIA.
DEVICES/REEL	250

PTDXXXXX	"X"	"Y"
PTD08A210	0mm	25.28mm

TRAY

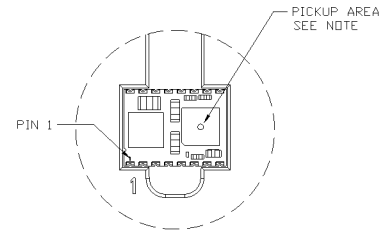
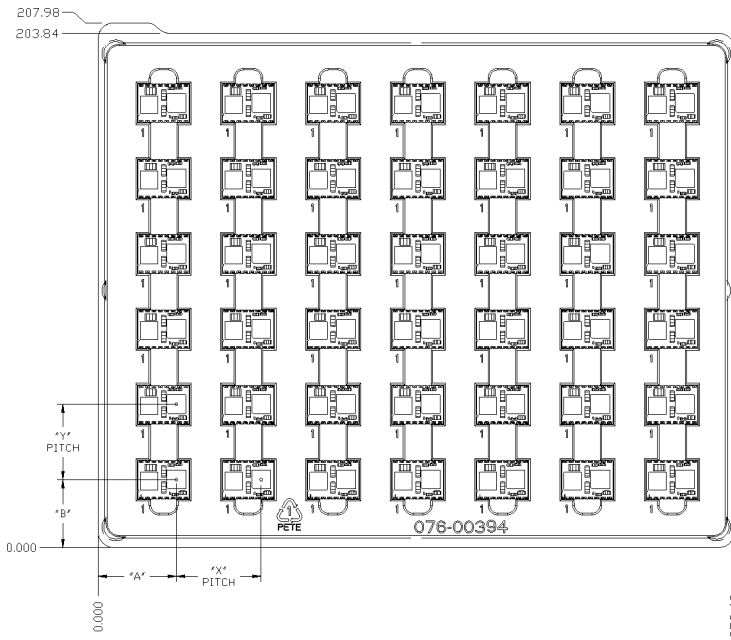

NOTE: THE INDUCTOR IS USED TO PICK AND PLACE THE MODULE. IT'S LOCATION MAY VARY FROM PACKAGE STYLE. SEE PRODUCT TABLE

PTDXXXXXX	"A"	"B"	"X"	"Y"
PTD08A210	31.08	26.95	33.61	29.85

ALL DIMENSIONS ARE IN MILLIMETER.

DEVICES/TRAY	42
--------------	----

PACKAGING INFORMATION

Orderable Device	Status (1)	Package Type	Package Drawing	Pins	Package Qty	Eco Plan (2)	Lead/Ball Finish (6)	MSL Peak Temp (3)	Op Temp (°C)	Device Marking (4/5)	Samples
PTD08A210WAC	ACTIVE	DIP MODULE	ECY	16	42	RoHS (In Work) & Green (In Work)	Call TI	Level-3-260C-168 HR	-40 to 85		Samples

(1) The marketing status values are defined as follows:

ACTIVE: Product device recommended for new designs.

LIFEBUY: TI has announced that the device will be discontinued, and a lifetime-buy period is in effect.

NRND: Not recommended for new designs. Device is in production to support existing customers, but TI does not recommend using this part in a new design.

PREVIEW: Device has been announced but is not in production. Samples may or may not be available.

OBsolete: TI has discontinued the production of the device.

(2) **RoHS:** TI defines "RoHS" to mean semiconductor products that are compliant with the current EU RoHS requirements for all 10 RoHS substances, including the requirement that RoHS substance do not exceed 0.1% by weight in homogeneous materials. Where designed to be soldered at high temperatures, "RoHS" products are suitable for use in specified lead-free processes. TI may reference these types of products as "Pb-Free".

RoHS Exempt: TI defines "RoHS Exempt" to mean products that contain lead but are compliant with EU RoHS pursuant to a specific EU RoHS exemption.

Green: TI defines "Green" to mean the content of Chlorine (Cl) and Bromine (Br) based flame retardants meet JS709B low halogen requirements of <=1000ppm threshold. Antimony trioxide based flame retardants must also meet the <=1000ppm threshold requirement.

(3) MSL, Peak Temp. - The Moisture Sensitivity Level rating according to the JEDEC industry standard classifications, and peak solder temperature.

(4) There may be additional marking, which relates to the logo, the lot trace code information, or the environmental category on the device.

(5) Multiple Device Markings will be inside parentheses. Only one Device Marking contained in parentheses and separated by a "~" will appear on a device. If a line is indented then it is a continuation of the previous line and the two combined represent the entire Device Marking for that device.

(6) Lead/Ball Finish - Orderable Devices may have multiple material finish options. Finish options are separated by a vertical ruled line. Lead/Ball Finish values may wrap to two lines if the finish value exceeds the maximum column width.

Important Information and Disclaimer:The information provided on this page represents TI's knowledge and belief as of the date that it is provided. TI bases its knowledge and belief on information provided by third parties, and makes no representation or warranty as to the accuracy of such information. Efforts are underway to better integrate information from third parties. TI has taken and continues to take reasonable steps to provide representative and accurate information but may not have conducted destructive testing or chemical analysis on incoming materials and chemicals. TI and TI suppliers consider certain information to be proprietary, and thus CAS numbers and other limited information may not be available for release.

In no event shall TI's liability arising out of such information exceed the total purchase price of the TI part(s) at issue in this document sold by TI to Customer on an annual basis.

ECY (R-PDSS-T16)

SINGLE SIDED MODULE

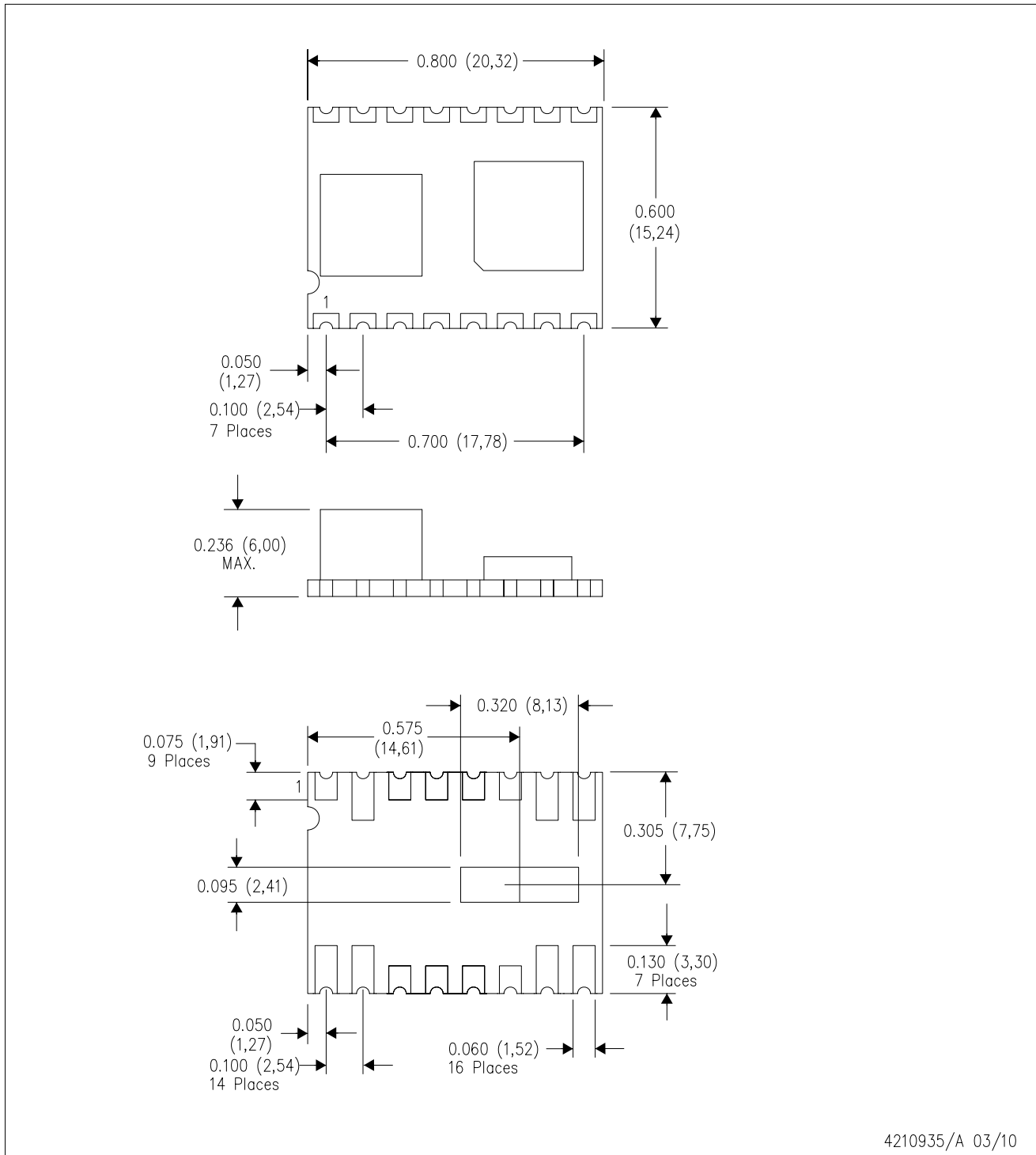

4210935/A 03/10

- NOTES:
- A. All linear dimensions are in inches (mm).
 - B. This drawing is subject to change without notice.
 - C. 2 place decimals are ± 0.030 ($\pm 0,76$ mm).
 - D. 3 place decimals are ± 0.010 ($\pm 0,25$ mm).

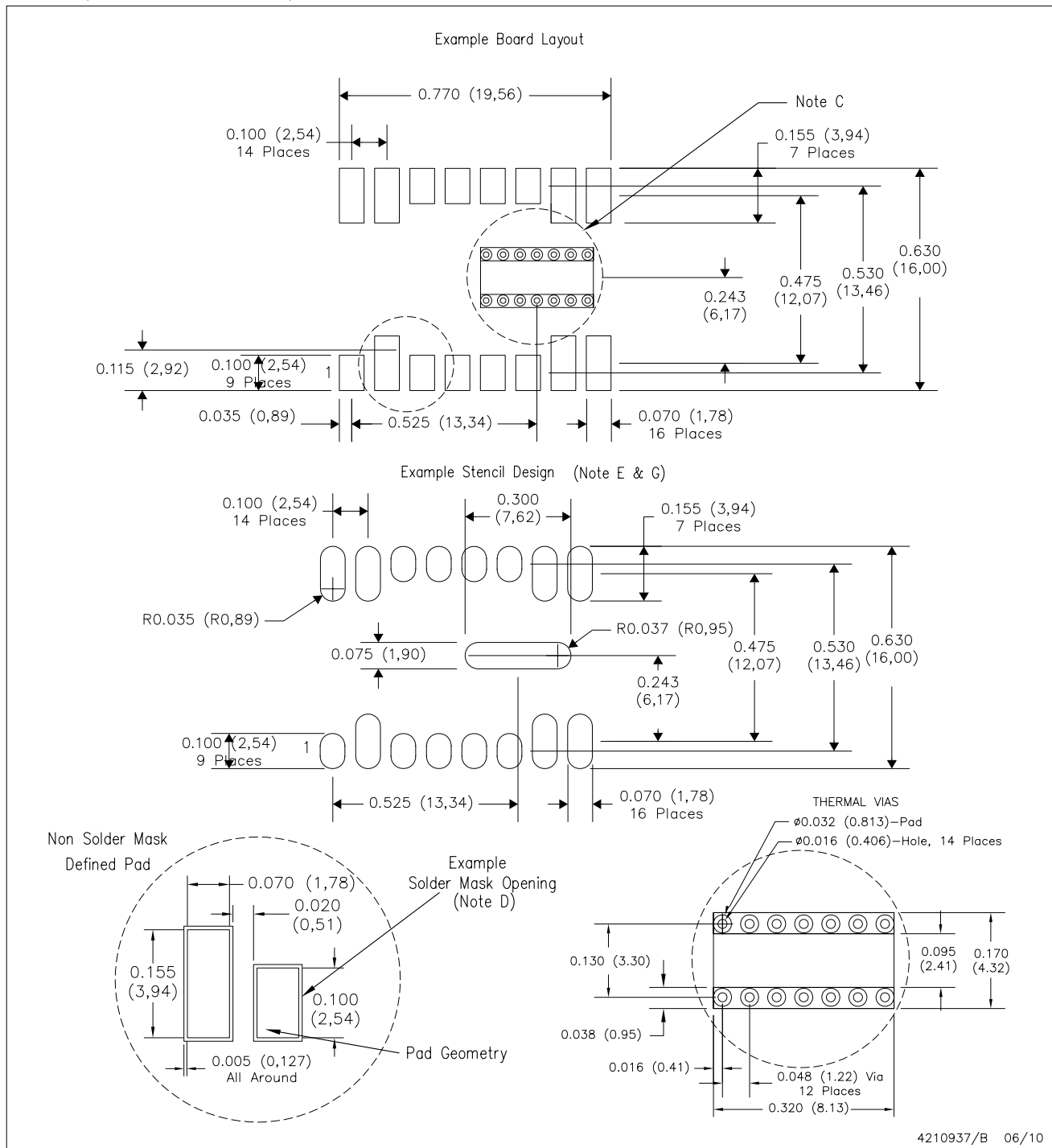

4210937/B 06/10

IMPORTANT NOTICE

Texas Instruments Incorporated (TI) reserves the right to make corrections, enhancements, improvements and other changes to its semiconductor products and services per JESD46, latest issue, and to discontinue any product or service per JESD48, latest issue. Buyers should obtain the latest relevant information before placing orders and should verify that such information is current and complete.

TI's published terms of sale for semiconductor products (<http://www.ti.com/sc/docs/stdterms.htm>) apply to the sale of packaged integrated circuit products that TI has qualified and released to market. Additional terms may apply to the use or sale of other types of TI products and services.

Reproduction of significant portions of TI information in TI data sheets is permissible only if reproduction is without alteration and is accompanied by all associated warranties, conditions, limitations, and notices. TI is not responsible or liable for such reproduced documentation. Information of third parties may be subject to additional restrictions. Resale of TI products or services with statements different from or beyond the parameters stated by TI for that product or service voids all express and any implied warranties for the associated TI product or service and is an unfair and deceptive business practice. TI is not responsible or liable for any such statements.

Buyers and others who are developing systems that incorporate TI products (collectively, "Designers") understand and agree that Designers remain responsible for using their independent analysis, evaluation and judgment in designing their applications and that Designers have full and exclusive responsibility to assure the safety of Designers' applications and compliance of their applications (and of all TI products used in or for Designers' applications) with all applicable regulations, laws and other applicable requirements. Designer represents that, with respect to their applications, Designer has all the necessary expertise to create and implement safeguards that (1) anticipate dangerous consequences of failures, (2) monitor failures and their consequences, and (3) lessen the likelihood of failures that might cause harm and take appropriate actions. Designer agrees that prior to using or distributing any applications that include TI products, Designer will thoroughly test such applications and the functionality of such TI products as used in such applications.

TI's provision of technical, application or other design advice, quality characterization, reliability data or other services or information, including, but not limited to, reference designs and materials relating to evaluation modules, (collectively, "TI Resources") are intended to assist designers who are developing applications that incorporate TI products; by downloading, accessing or using TI Resources in any way, Designer (individually or, if Designer is acting on behalf of a company, Designer's company) agrees to use any particular TI Resource solely for this purpose and subject to the terms of this Notice.

TI's provision of TI Resources does not expand or otherwise alter TI's applicable published warranties or warranty disclaimers for TI products, and no additional obligations or liabilities arise from TI providing such TI Resources. TI reserves the right to make corrections, enhancements, improvements and other changes to its TI Resources. TI has not conducted any testing other than that specifically described in the published documentation for a particular TI Resource.

Designer is authorized to use, copy and modify any individual TI Resource only in connection with the development of applications that include the TI product(s) identified in such TI Resource. NO OTHER LICENSE, EXPRESS OR IMPLIED, BY ESTOPPEL OR OTHERWISE TO ANY OTHER TI INTELLECTUAL PROPERTY RIGHT, AND NO LICENSE TO ANY TECHNOLOGY OR INTELLECTUAL PROPERTY RIGHT OF TI OR ANY THIRD PARTY IS GRANTED HEREIN, including but not limited to any patent right, copyright, mask work right, or other intellectual property right relating to any combination, machine, or process in which TI products or services are used. Information regarding or referencing third-party products or services does not constitute a license to use such products or services, or a warranty or endorsement thereof. Use of TI Resources may require a license from a third party under the patents or other intellectual property of the third party, or a license from TI under the patents or other intellectual property of TI.

TI RESOURCES ARE PROVIDED "AS IS" AND WITH ALL FAULTS. TI DISCLAIMS ALL OTHER WARRANTIES OR REPRESENTATIONS, EXPRESS OR IMPLIED, REGARDING RESOURCES OR USE THEREOF, INCLUDING BUT NOT LIMITED TO ACCURACY OR COMPLETENESS, TITLE, ANY EPIDEMIC FAILURE WARRANTY AND ANY IMPLIED WARRANTIES OF MERCHANTABILITY, FITNESS FOR A PARTICULAR PURPOSE, AND NON-INFRINGEMENT OF ANY THIRD PARTY INTELLECTUAL PROPERTY RIGHTS. TI SHALL NOT BE LIABLE FOR AND SHALL NOT DEFEND OR INDEMNIFY DESIGNER AGAINST ANY CLAIM, INCLUDING BUT NOT LIMITED TO ANY INFRINGEMENT CLAIM THAT RELATES TO OR IS BASED ON ANY COMBINATION OF PRODUCTS EVEN IF DESCRIBED IN TI RESOURCES OR OTHERWISE. IN NO EVENT SHALL TI BE LIABLE FOR ANY ACTUAL, DIRECT, SPECIAL, COLLATERAL, INDIRECT, PUNITIVE, INCIDENTAL, CONSEQUENTIAL OR EXEMPLARY DAMAGES IN CONNECTION WITH OR ARISING OUT OF TI RESOURCES OR USE THEREOF, AND REGARDLESS OF WHETHER TI HAS BEEN ADVISED OF THE POSSIBILITY OF SUCH DAMAGES.

Unless TI has explicitly designated an individual product as meeting the requirements of a particular industry standard (e.g., ISO/TS 16949 and ISO 26262), TI is not responsible for any failure to meet such industry standard requirements.

Where TI specifically promotes products as facilitating functional safety or as compliant with industry functional safety standards, such products are intended to help enable customers to design and create their own applications that meet applicable functional safety standards and requirements. Using products in an application does not by itself establish any safety features in the application. Designers must ensure compliance with safety-related requirements and standards applicable to their applications. Designer may not use any TI products in life-critical medical equipment unless authorized officers of the parties have executed a special contract specifically governing such use. Life-critical medical equipment is medical equipment where failure of such equipment would cause serious bodily injury or death (e.g., life support, pacemakers, defibrillators, heart pumps, neurostimulators, and implantables). Such equipment includes, without limitation, all medical devices identified by the U.S. Food and Drug Administration as Class III devices and equivalent classifications outside the U.S.

TI may expressly designate certain products as completing a particular qualification (e.g., Q100, Military Grade, or Enhanced Product). Designers agree that it has the necessary expertise to select the product with the appropriate qualification designation for their applications and that proper product selection is at Designers' own risk. Designers are solely responsible for compliance with all legal and regulatory requirements in connection with such selection.

Designer will fully indemnify TI and its representatives against any damages, costs, losses, and/or liabilities arising out of Designer's non-compliance with the terms and provisions of this Notice.