

ORDERING INFORMATION

PTHXX060Y (Base Part Number)				
Input Voltage	Part Number ⁽¹⁾	DESCRIPTION	Pb – free and RoHS	Mechanical Package ⁽²⁾
3.3 V	PTH03060YAH	Horizontal T/H	Yes ⁽³⁾	EUW
	PTH03060YAS	Standard SMD	No ⁽⁴⁾	EUY
	PTH03060YAZ	Optional SMD	Yes ⁽³⁾	EUY
5 V	PTH05060YAH	Horizontal T/H	Yes ⁽³⁾	EUW
	PTH05060YAS	Standard SMD	No ⁽⁴⁾	EUY
	PTH05060YAZ	Optional SMD	Yes ⁽³⁾	EUY
12 V	PTH12060YAH	Horizontal T/H	Yes ⁽³⁾	EUW
	PTH12060YAS	Standard SMD	No ⁽⁴⁾	EUY
	PTH12060YAZ	Optional SMD	Yes ⁽³⁾	EUY

- (1) Add *T* to end of part number for tape and reel on SMD packages only.
- (2) Reference the applicable package reference drawing for the dimensions and PC board layout.
- (3) *Lead (Pb) –free* option specifies Sn/Ag pin solder material.
- (4) *Standard* option specifies 63/37, Sn/Pb pin solder material.

ENVIRONMENTAL AND ABSOLUTE MAXIMUM RATINGS

voltages are with respect to GND

			UNIT
V _{REF}	Control input voltage		–0.3 V to V _{in} +03 V
T _A	Operating temperature range	Over V _{IN} range	–40°C to 85°C ⁽¹⁾
T _{wave}	Wave solder temperature	Surface temperature of module body or pins (5 seconds)	PTHXX060YAH 260°C ⁽²⁾
T _{reflow}	Solder reflow temperature	Surface temperature of module body or pins	PTHXX060YAS 235°C ⁽²⁾
			PTHXX060YAZ 260°C ⁽²⁾
T _s	Storage temperature		–40°C to 125°C
	Mechanical shock	Per Mil-STD-883D, Method 2002.3 1 msec, 1/2 Sine, mounted	500 G
	Mechanical vibration	Mil-STD-883D, Method 2007.2 20-2000 Hz	20 G
	Weight		3.7 grams
	Flammability	Meets UL 94V-O	

- (1) For operation below 0°C, the external capacitors must have stable characteristics, use either a low ESR tantalum, Os-Con, or ceramic capacitor.
- (2) During soldering of package version, do not elevate peak temperature of the module, pins or internal components above the stated maximum.

ELECTRICAL SPECIFICATIONS
 $T_A = 25^\circ\text{C}$; nominal V_{IN} ; $V_{REF} = 1.25\text{ V}$; C_{IN} , C_{O1} , and C_{O2} = typical values; and $I_O = I_{Omax}$ (unless otherwise stated)

PARAMETER		TEST CONDITIONS		MIN	TYP	MAX	UNIT	
I_O	Output current	Over ΔV_{REF} range	Continuous	0		$\pm 10^{(1)}$	A	
V_{IN}	Input voltage range	Over I_O range	PTH03060Y	2.95		3.65	V	
			PTH05060Y	4.5		5.5		
			PTH12060Y	10.8		13.2		
ΔV_{REF}	Tracking range for V_{REF}			0.55		1.8	V	
$ V_{TT} - V_{REF} $	Tracking tolerance to V_{REF}	Over line, load and temperature		-10		10	mV	
η	Efficiency	$I_O = 8\text{ A}$	PTH03060Y		86%			
			PTH05060Y		86%			
			PTH12060Y		83%			
V_r	V_O Ripple (pk-pk)	20 MHz bandwidth			20		mVpp	
I_O trip	Overcurrent threshold	Reset, followed by auto recovery				20	A	
t_{tr}	Load transient response	15 A/ μs load step, from: -1.5 A to 1.5 A	Recovery time		30		μsec	
V_{tr}			V_O over/undershoot		25	40	mV	
UVLO	Under-voltage lockout	V_{IN} Increasing	PTH03060Y		2.45	2.8	V	
			PTH05060Y		4.3	4.45		
			PTH12060Y		9.5	10.4		
		V_{IN} Dncreasing	PTH03060Y	2.0	2.40	V		
			PTH05060Y	3.4	3.7			
			PTH12060Y	8.8	9			
V_{IH}	Inhibit control (pin 4) Input high voltage	Referenced to GND		$V_{IN} - 0.5$		Open ⁽²⁾	V	
V_{IL}	Inhibit control (pin 4) Input low voltage			-0.2		0.6	V	
I_{IL} inhibit	Inhibit control (pin 4) Input low curent	Pin to GND			130		μA	
I_{IN} inh	Input standby current	Inhibit control (pin 4) to GND			10		mA	
f_s	Switching frequency	Over V_{IN} and I_O ranges	PTH03060Y/PTH05060Y	250	300	350	kHz	
			PTH12060Y	200	250	300		
C_{IN}	External input capacitance		PTH03060Y/PTH05060Y	330 ⁽³⁾			μF	
			PTH12060Y	560				
C_{O1} , C_{O2}	External output capacitance	Capacitance value: Nonceramic	PTH03060Y/PTH05060Y	470 ⁽⁴⁾		5500 ⁽⁵⁾	μF	
			PTH12060Y	940 ⁽⁴⁾		5500 ⁽⁵⁾		
		Capacitance value: Ceramic	PTH03060Y/PTH05060Y		200 ⁽⁴⁾		300	μF
			PTH12060Y		400 ⁽⁴⁾		600	
		Equivanent series resistance (non-ceramic)		4 ⁽⁶⁾			m Ω	
MTBF	Reliability	Per Bellcore TR-332 50 % stress, $T_A = 40^\circ\text{C}$, ground benign		6			10^6 Hrs	

- (1) Rating is conditional on the module being directly soldered to a 4-layer PCB with 1 oz. copper. See the SOA curves or contact the factory for appropriate derating.
- (2) This control pin has an internal pull-up to the input voltage V_{IN} . If it is left open-circuit the module will operate when input power is applied. A small low-leakage (<100 nA) MOSFET is recommended for control. For further information, consult the related application note.
- (3) An input capacitor is required for proper operation. The capacitor must be rated for a minimum of 300 mA rms (750 mA rms for 12-V input) of ripple current.
- (4) The minimum value of external output capacitance value ensures that VTT meets the specified transient performance requirements for the memory bus terminations. Lower values of capacitance may be possible when the *measured* peak change in output current is consistently less than 3 A.
- (5) This is the calculated maximum. The minimum ESR limitation will often result in a lower value. Consult the capacitor application notes for further guidance.
- (6) This is the typical ESR for all the electrolytic (non-ceramic) output capacitance. Use 7 m Ω as the minimum when using max-ESR values to calculate.

Terminal Functions

TERMINAL		DESCRIPTION
NAME	NO.	
V _{IN}	2	The positive input voltage power node to the module, which is referenced to common GND.
GND	1, 7	This is the common ground connection for the V _{IN} and V _{TT} power connections. It is also the 0-VDC reference for the control inputs.
V _{REF}	8	The module senses the voltage at this input to regulate the output voltage, V _{TT} . The voltage at V _{REF} is also the reference voltage for the system bus receiver comparators. It is normally set to precisely half the bus driver supply voltage (V _{DDQ} ± 2), using a resistor divider. The Thevenin impedance of the network driving the V _{REF} pin should not exceed 500 Ω. See the Typical DDR Application Diagram in the Application Information section for reference.
V _{TT}	6	This is the regulated power output from the module with respect to the GND node, and the tracking termination supply for the application data and address buses. It is precisely regulated to the voltage applied to the module's V _{REF} input, and is active active about 20 ms after a valid input source is applied to the module. Once active it will track the voltage applied at V _{REF} .
V _o Sense	5	The sense input allows the regulation circuit to compensate for voltage drop between the module and the load. For optimal voltage accuracy V _o Sense should be connected to V _{TT} .
Inhibit	3	The Inhibit pin is an open-collector/drain negative logic input that is referenced to GND. Applying a low-level ground signal to this input turns off the output voltage, V _{TT} . Although the module is inhibited, a voltage, V _{DDQ} will be present at the output terminals, fed through the DDR memory. When the Inhibit is active, the input current drawn by the regulator is significantly reduced. If the Inhibit pin is left open circuit, the module will produce an output whenever a valid input source is applied. See the Typical DDR Application Diagram in the Application Information section for reference.
N/C	4, 9, 10	No connect

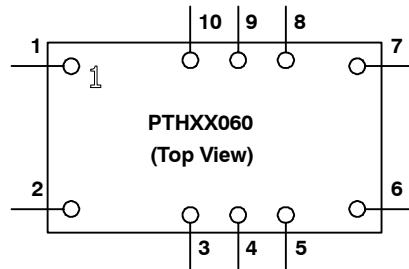

TYPICAL CHARACTERISTICS ($V_{REF} = 1.25\text{ V}$)^{(1) (2)}

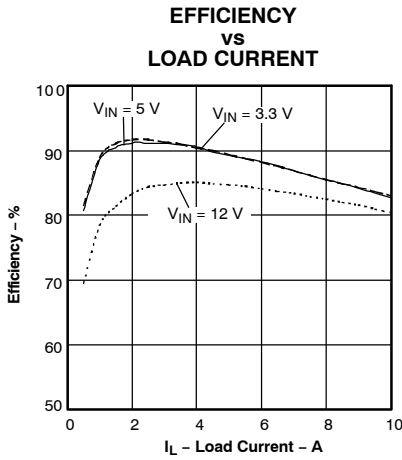

Figure 1.

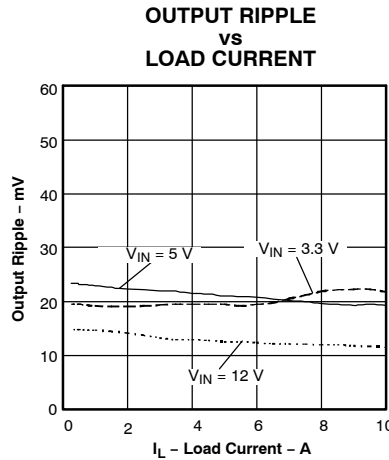

Figure 2.

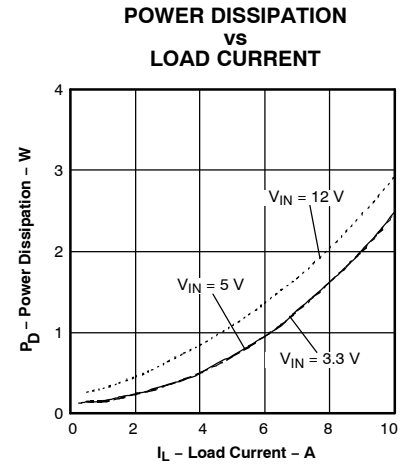

Figure 3.

PTH03060Y/PTH05060Y AT
NOMINAL V_{IN}
TEMPERATURE DERATING
vs LOAD CURRENT

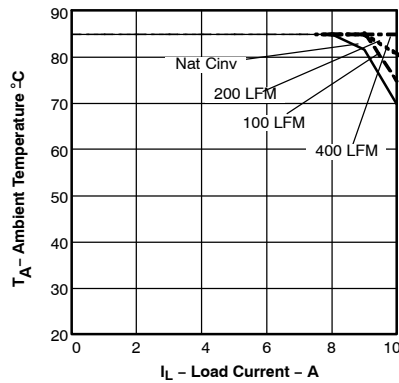

Figure 4.

PTH12060Y ONLY; $V_{IN} = 12\text{ V}$
TEMPERATURE DERATING
vs LOAD CURRENT

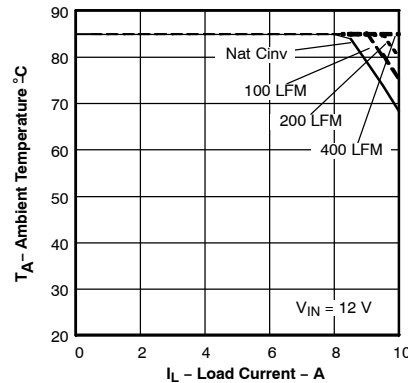

Figure 5.

- (1) The electrical characteristic data has been developed from actual products tested at 25°C. This data is considered typical for the converter. Applies to [Figure 1](#), [Figure 2](#), and [Figure 3](#).
- (2) The temperature derating curves represent the conditions at which internal components are at or below the manufacturer's maximum operating temperatures. Derating limits apply to modules soldered directly to a 4 in x 4 in double-sided PCB with 1 oz. copper. For surface mount packages (AS and AZ suffix), multiple vias (plated through holes) are required to add thermal paths around the power pins. Please refer to the mechanical specification for more information. Applies to [Figure 4](#), and [Figure 5](#).

TYPICAL CHARACTERISTICS

TRANSIENT PERFORMANCE FOR $\Delta 3$ -A LOAD CHANGE

PTH03060Y/PTH05060Y: SOURCE-SINK-SOURCE
TRANSIENT

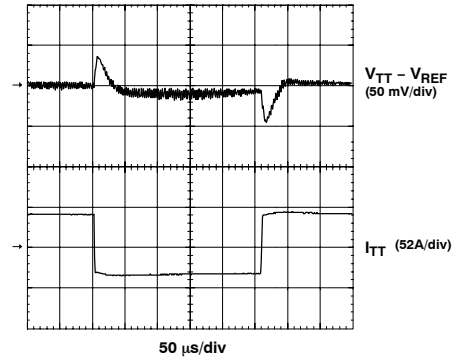

Figure 6.

PTH12060Y: SOURCE-SINK-SOURCE TRANSIENT

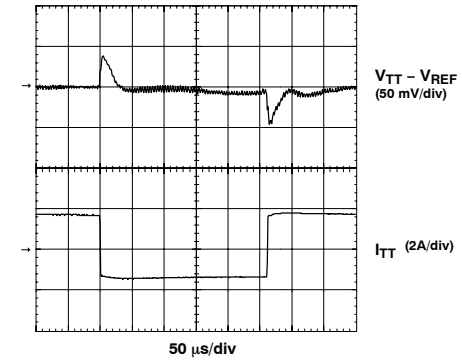
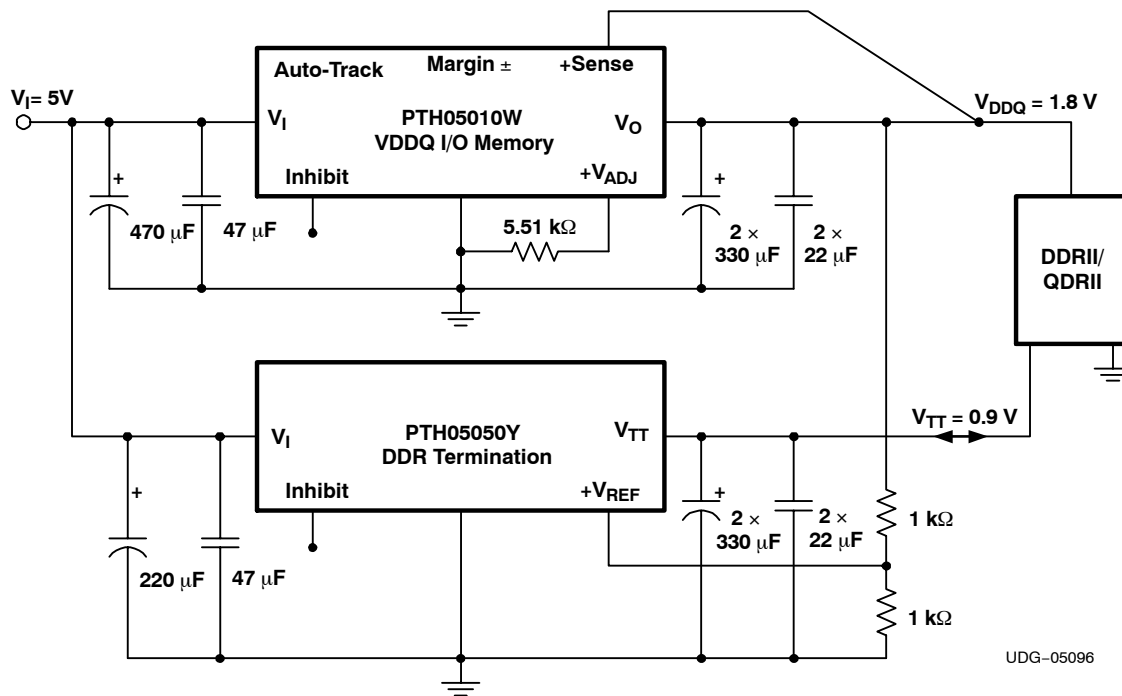

Figure 7.

APPLICATION INFORMATION

Typical DDR Application Diagram



UDG-05096

CAPACITOR RECOMMENDATIONS FOR THE PTH03060Y AND PTH05060Y DDR POWER MODULES (3.3-V/5-V OPTION)

Input Capacitor

The recommended input capacitor(s) is determined by the 330 μF⁽¹⁾ minimum capacitance and 300 mArms minimum ripple current rating.

Ripple current and less than 160 mΩ equivalent series resistance (ESR) values are the major considerations, along with temperature, when designing with different types of capacitors. Unlike polymer tantalum, regular tantalum capacitors have a recommended minimum voltage rating of 2 × (maximum DC voltage + AC ripple). This is standard practice to insure reliability.

For improved ripple reduction on the input bus, ceramic capacitors may be substituted for electrolytic types using the minimum required capacitance.

Output Capacitors

For applications with load transients (sudden changes in load current), regulator response will benefit from external output capacitance. The recommended output capacitance of 470 μF will allow the module to meet its transient response specification (see Electrical Specifications table). For most applications, a high quality computer-grade aluminum electrolytic capacitor is adequate. These capacitors provide decoupling over the frequency range, 2 kHz to 150 kHz, and are suitable when ambient temperatures are above 0°C. For operation below 0°C tantalum, ceramic or Os-Con type capacitors are recommended. When using one or more non-ceramic capacitors, the calculated equivalent ESR should be no lower than 4 mΩ (7 mΩ using the manufacturer's maximum ESR for a single capacitor). A list of preferred low-ESR type capacitors are identified in [Table 1](#).

APPLICATION INFORMATION (continued)

Ceramic Capacitors

Above 150 kHz the performance of aluminum electrolytic capacitors becomes less effective. To further improve the reflected input ripple current or the output transient response. Multilayer ceramic capacitors have very low ESR and their resonant frequency higher than the bandwidth of the regulator. They can be used to reduce the reflected ripple current at the input as well as improve the transient response of the output. When used on the output their combined ESR is not critical as long as the total value of ceramic capacitance does not exceed 300 μF . Also, to prevent the formation of local resonances, do not place more than five identical ceramic capacitors in parallel with values of 10 μF or greater.

Tantalum Capacitors

Tantalum type capacitors can be used at both the input and output, and are recommended for applications where the ambient operating temperature can be less than 0°C. The AVX TPS, Sprague 593D/594/595 and Kemet T495/T510 capacitor series are suggested over many other tantalum types due to their higher rated surge, power dissipation, and ripple current capability. As a caution many general purpose tantalum capacitors have considerably higher ESR, reduced power dissipation and lower ripple current capability. These capacitors are also less reliable when determining their power dissipation and surge current rating. Tantalum capacitors that do not have a stated ESR or surge current rating are not recommended for power applications.

When specifying Os-Con and polymer tantalum capacitors for the output, the minimum ESR limit will be encountered well before the maximum capacitance value is reached.

Capacitor Table

Table 1 identifies the characteristics of capacitors from a number of vendors with acceptable ESR and ripple current (rms) ratings. The recommended number of capacitors required at both the input and output buses is identified for each capacitor type.

This is not an extensive capacitor list. Capacitors from other vendors are available with comparable specifications. Those listed are for guidance. The RMS ripple current rating and ESR (at 100 kHz) are critical parameters necessary to insure both optimum regulator performance and long capacitor life.

Table 1. Input/Output Capacitors⁽¹⁾

Capacitor Vendor, Type/Series (Style)	Capacitor Characteristics					Quantity		Vendor Part Number
	Working Voltage (V)	Value (μF)	Max ESR at 100 kHz (Ω)	Max Ripple Current at 85°C (Irms) (mA)	Physical Size (mm)	Input Bus	Output Bus	
Panasonic, Aluminum								
FC (Radial)	10	470	0.117	555	8x11,5	1	1	EEUFC1A471
FK (SMD)	10	470	0.160	600	8x10,2	1	1	EEVFK1A471P
FC (SMD)	10	470	0.150	670	10x10,2	1	1	EEVFC1A471P
United Chemi-Con								
PXA, Poly-Aluminum (SMD)	10	470	0.012	5300	10x12,2	1	≤ 1	PXA10VC471MJ12TP
PS, Poly-Aluminum (Radial)	10	470	0.012	5300	8x12,2	1	≤ 1	10PS470MJ12
LXZ, Aluminum (Radial)	10	470	0.120	555	8x12	1	1	LXZ10VB471M8X12LL
Nichicon Aluminum								
WG (SMD)	10	470	0.150	670	10x10	1	1	UWG1A471MNR1GS
HD (Radial)	10	470	0.072	760	8x11.5	1	1	UHD1A471MPR
PM (Radial)	16	330	0.120	625	10x12,5	1	2	UPM1C331MPH6

(1) Capacitor Supplier Verification

Please verify availability of capacitors identified in this table. Capacitor suppliers may recommend alternative part numbers because of limited availability or obsolete products. In some instances, the capacitor product life cycle may be in decline and have short-term consideration for obsolescence.

RoHS, Lead-free and Material Details

Please consult capacitor suppliers regarding material composition, RoHS status, lead-free status, and manufacturing process requirements. Component designators or part number deviations can occur when material composition or soldering requirements are updated.

APPLICATION INFORMATION (continued)
Table 1. Input/Output Capacitors (continued)

Capacitor Vendor, Type/Series (Style)	Capacitor Characteristics					Quantity		Vendor Part Number
	Working Voltage (V)	Value (μ F)	Max ESR at 100 kHz (Ω)	Max Ripple Current at 85°C (Irms) (mA)	Physical Size (mm)	Input Bus	Output Bus	
Panasonic, Poly-Aluminum: S/SE (SMD)	6.3	180	0.005	4000	7,,3x4,3x4,2	2	N/R ⁽²⁾	EEFSE0J181R
Sanyo SEPC, Os-con (Radial)	16	470	0.010	6100	10x13	1	\leq 1	16SEPC470M
SVP (SMD)	6.3	470	0.015	4210	8x11,9	1	\leq 2	6SVP470M
TPE, Poscap (SMD)	6.3	330	0.025	2400	7.3x4.3	1	\leq 3	6TPE330ML
AVX, Tantalum TPS Series III	10	470	0.045	1915	7.3L x5.7W x4.1H	1	\leq 5	TPSE477M010R0045
TPS (SMD)	10	470	0.100	1432		1	\leq 5	TPSV477M010R0100
Kemet, Poly-Tantalum T520 (SMD)	10	330	0.040	1800	4.3W x7.3L x4.0H	1	1	T520X337M010AS
T530 (SMD)	10	330	0.010	>5200		1	\leq 1	T530X337M010ASE010
Vishay-Sprague 595D, Tantalum (SMD)	10	330	0.100	1040		1	\leq 5	595D377x0010D2T
594D, Tantalum (SMD)	10	330	0.045	2360		1	\leq 5	594D337X0016R2T
94SA, Poly-Aluminum (SMD)	6.3	330	0.025	3500	7.2Lx6W x4.1H	1	\leq 3	94SA337X06R3FBP
94SVP, Poly-Aluminum (SMD)	6.3	470	0.017	3960	10 x10,5 8,3x12	1	\leq 2	94SVP477X06R3E12
Kemet, Ceramic X5R (SMD)	16	10	0.002	–	3225 mm	1	\leq 5	C1210C106M4PAC
	6.3	47	0.002		3225 mm	1	\leq 5	C1210C476K9PAC
Murata, Ceramic X5R (SMD)	6.3	100	0.002	–	3225 mm	1 ⁽³⁾	\leq 3	GRM32ER60J107M
	6.3	47			3225 mm	1 ⁽³⁾	\leq 5	GRM32ER60J476M
	16	22				1 ⁽³⁾	\leq 5	GRM32ER61C226K
	16	10				1 ⁽³⁾	\leq 5	GRM32DR61C106K
TDK, Ceramic X5R (SMD)	6.3	100	0.002	–	3225 mm	1 ⁽³⁾	\leq 3	C3225X5R0J107MT
	6.3	47			3225 mm	1 ⁽³⁾	\leq 5	C3225X5R0J476MT
	16	22				1 ⁽³⁾	\leq 5	C3225X5R1C226MT
	16	10				1 ⁽³⁾	\leq 5	C3225X5R1C106MT

(2) N/R – Not recommended. The capacitor does not meet the minimum operating limits.

(3) A ceramic capacitor may be used to compliment electrolytic types at the input to further reduce high-frequency ripple current.

Designing for Very Fast Load Transients

The transient response of the DC/DC converter has been characterized using a load transient with a di/dt of 1 A/ μ s. The typical voltage deviation for this load transient is given in the data sheet specification table using the optional value of output capacitance. As the di/dt of a transient is increased, the response of a converter's regulation circuit ultimately depends on its output capacitor decoupling network. This is an inherent limitation with any DC/DC converter once the speed of the transient exceeds its bandwidth capability. If the target application specifies a higher di/dt or lower voltage deviation, the requirement can only be met with additional output capacitor decoupling. In these cases special attention must be paid to the type, value and ESR of the capacitors selected.

If the transient performance requirements exceed that specified in the data sheet, or the total amount of load capacitance is above 5500 μ F, the selection of output capacitors becomes more important.

CAPACITOR RECOMMENDATIONS FOR THE PTH12060Y DDR POWER MODULES (12-V OPTION)

Input Capacitor

The recommended input capacitance is determined by the 560 μF ^[1] minimum capacitance and 750 mArms minimum ripple current rating. A 10- μF X5R/X7R ceramic capacitor can be added to reduce the reflected input ripple current. The ceramic capacitor should be located between the input electrolytic and the module.

Ripple current, less than 100 m Ω equivalent series resistance (ESR) and temperature, are major considerations when selecting input capacitors. Unlike polymer-tantalum capacitors, regular tantalum capacitors have a recommended minimum voltage rating of $2 \times$ (max. dc voltage + ac ripple). No tantalum capacitors were found with sufficient voltage rating to meet this requirement. At temperatures below 0°C, the ESR of aluminum electrolytic capacitors increases. For these applications, Os-Con, polymer-tantalum, and polymer-aluminum types should be considered.

Output Capacitors

For applications with load transients (sudden changes in load current), regulator response will benefit from external output capacitance. The recommended output capacitance of 940 μF will allow the module to meet its transient response specification (See Electrical Specifications table). For most applications, a high quality, computer-grade aluminum electrolytic capacitor is adequate. These capacitors provide decoupling over the frequency range, 2 kHz to 150 kHz, and are suitable for ambient temperatures above 0°C. Below 0°C, tantalum, ceramic, or Os-Con type capacitors are recommended. When using one or more nonceramic capacitors, the calculated equivalent ESR should be no lower than 4 m Ω (7 m Ω using the manufacturer's maximum ESR for a single capacitor).

A list of preferred low-ESR type capacitors are identified in [Table 2](#).

In addition to electrolytic capacitance, adding a 10- μF to 22- μF X5R/X7R ceramic capacitor to the output reduces the output ripple voltage and improves the regulator's transient response. The measurement of both the output ripple and transient response is also best achieved across a 10- μF ceramic capacitor.

Ceramic Capacitors

Above 150 kHz, the performance of aluminum electrolytic capacitors is less effective. Multilayer ceramic capacitors have a low ESR and a resonant frequency higher than the bandwidth of the regulator. They can be used to reduce the reflected ripple current at the input, and improve the transient response of the output. When used on the output, their combined ESR is not critical as long as the total value of ceramic capacitance does not exceed 600 μF . Also, to prevent the formation of local resonances, do not place more than five identical ceramic capacitors in parallel with values of 10 μF or greater.

Tantalum Capacitors

Tantalum type capacitors are most suited for use on the output bus, and are recommended for applications where the ambient operating temperature can be less than 0°C. The AVX TPS, Sprague 593D/594/595, and Kemet T495/T510 capacitor series are suggested over other tantalum types due to their higher rated surge, power dissipation, and ripple current capability. As a caution, many general-purpose tantalum capacitors have considerably higher ESR, reduced power dissipation, and lower ripple current capability. These capacitors are also less reliable as they have lower power dissipation and surge current ratings. Tantalum capacitors that do not have a stated ESR or surge current rating are not recommended for power applications.

When specifying Os-con and polymer tantalum capacitors for the output, the minimum ESR limit is encountered well before the maximum capacitance value is reached.

Capacitor Table

[Table 2](#) identifies the characteristics of capacitors from a number of vendors with acceptable ESR and ripple current (rms) ratings. The recommended number of capacitors required at both the input and output buses is identified for each capacitor type.

Note: This is not an extensive capacitor list. Capacitors from other vendors are available with comparable specifications. Those listed are for guidance. The RMS ripple current rating and ESR (at 100 kHz) are critical parameters necessary to insure both optimum regulator performance and long capacitor life.

Designing for Very Fast Load Transients

The transient response of the dc/dc converter is characterized using a load transient with a di/dt of $1\text{ A}/\mu\text{s}$. The typical voltage deviation for this load transient is given in the data sheet specification table using the optional value of output capacitance. As the di/dt of a transient is increased, the response of a converter's regulation circuit ultimately depends on its output capacitor decoupling network. This is an inherent limitation with any dc/dc converter once the speed of the transient exceeds its bandwidth capability. If the target application specifies a higher di/dt or lower voltage deviation, the requirement is met with additional output capacitor decoupling. In these cases, special attention must be paid to the type, value, and ESR of the capacitors selected.

If the transient performance requirements exceed that specified in this data sheet, or the total amount of load capacitance is above $5500\ \mu\text{F}$, the selection of output capacitors becomes more important.

Table 2. Input/Output Capacitors⁽¹⁾

Capacitor Vendor, Type/Series (Style)	Capacitor Characteristics					Quantity		Vendor Number
	Working Voltage (V)	Value (μF)	Max ESR at 100 kHz (Ω)	Max Ripple Current at 85°C (Irms) (mA)	Physical Size (mm)	Input Bus	Output Bus	
Panasonic, Aluminum	25	560	0.065	1205	12,5 × 15	1	1	EEUFC1E561S
FC (Radial)	25	1000	0.060	1100	12,5 × 13,5	1	1	EEVFK1E102Q
FK (SMD)	35	680	0.060	1100	12,5 × 13,5	1	1	EEVFK1V681Q
United Chemi-Con								
LXZ, Aluminum (Radial)	16	330	0.0014	5050	10 × 12,5	2	≤2	16PS330MJ12
PS, Poly-Aluminum (Radial)	16	680	0.068	1050	10 × 16	1	1	LXZ16VB681M10X16LL
PXA, Poly-Aluminum (SMD)	16	330	0.014	5050	10 × 12,2	2	≤2	PXA16VC331MJ12
Nichicon Aluminum	25	560	0.060	1060	12,5 × 15	1	1	UPM1E561MHH6
PM (Radial)	16	680	0.038	1430	10 × 16	1	1	UHD1C681MHR
HD (Radial)	35	560	0.048	1360	16 × 15	1	1	UPM1V561MHH6
Sanyo								
TPE, pos-cap (SMD)	10	330	0.025	3000	7,3 L × 5,7 W	N/R ⁽²⁾	≤3	10TPE330M
SEPC, Os-con (Radial)	16	270	0.011	5000	8 × 12	2 ⁽³⁾	≤1	16SP270M
SVP, Os-con (SMD)	16	330	0.016	4700	11 × 12	2	≤2	16SVP330M
SVPC, Os-con (SMD)	4	1200	0.010	4700	8 × 11,9	N/R ⁽²⁾	≤1	4SVPC1200M
AVX, Tantalum								
TPS Series III (SMD)	10	470	0.045	>1723	7,3 L × 5,7 W × 4,1H	N/R ⁽²⁾	≤5	TPSE477M019R0045
TPS (SMD)	10	330	0.045	>1723	7,3 L × 4,3 W × 4,3 H	N/R ⁽²⁾	≤5	TPSE337M019R0045
Kemet								
T520, Poly-Tantalum (SMD)	10	470	0.040	1800	7,3 L × 4,3 W × 4,3 H	N/R ⁽²⁾	≤5	T520X477M006ASE040
T530, Tantalum/Organic (SMD)	4	680	0.010	>5100	7,3 L × 4,3 W × 4,3 H	N/R ⁽²⁾	≤1	T530X687M004ASE010
	6.3	470	0.010	5200	7,3 L × 4,3 W × 4,3 H	N/R ⁽²⁾	≤1	T530X477M006ASE010
Vishay-Sprague								
594D, Tantalum (SMD)	10	470	0.100	1440	7,2 L × 6 W × 4,1 H	N/R ⁽²⁾	≤5	595D477X0010R2T
94SA, organic (Radial)	16	1000	0.015	>9700	16 × 25	1	≤2	94Sa108X0016HBP
94SVP, Organic (SMD)	16	330	0.017	>4500	10 × 12,7	2	≤2	94SVP477X0016F12

(1) Capacitor Supplier Verification

Please verify availability of capacitors identified in this table. Capacitor suppliers may recommend alternative part numbers because of limited availability or obsolete products. In some instances, the capacitor product life cycle may be in decline and have short-term consideration for obsolescence.

RoHS, Lead-free and Material Details

Please consult capacitor suppliers regarding material composition, RoHS status, lead-free status, and manufacturing process requirements. Component designators or part number deviations can occur when material composition or soldering requirements are updated.

(2) N/R – Not recommended. The capacitor voltage rating does not meet the minimum operating limits.

(3) A total capacitance of $540\ \mu\text{F}$ is acceptable based on the combined ripple current rating.

Table 2. Input/Output Capacitors (continued)

Capacitor Vendor, Type/Series (Style)	Capacitor Characteristics					Quantity		Vendor Number
	Working Voltage (V)	Value (μF)	Max ESR at 100 kHz (Ω)	Max Ripple Current at 85°C (I _{rms}) (mA)	Physical Size (mm)	Input Bus	Output Bus	
Kemet, Ceramic X5R (SMD)	16	10	0.002		3225 mm	1 ⁽⁴⁾	≤5	C1210C106M4PAC
	6.3	47	0.002		3225 mm	N/R ⁽²⁾	≤5	C1210C476K9PAC
Murata, Ceramic X5R (SMD)	6.3	100	0.002		3225 mm	N/R ⁽²⁾	≤4	GRM32ER60J107M
	6.3	47			3225 mm	N/R ⁽²⁾	≤5	GRM32ER60J476M
	16	22				1 ⁽⁴⁾	≤5	GRM32ER61C226K
	16	10				1 ⁽⁴⁾	≤5	GRM32DR61C106K
TDK, Ceramic X5R (SMD)	6.3	100	0.002		3225 mm	N/R ⁽²⁾	≤4	C3225X5R0J107MT
	6.3	47			3225 mm	N/R ⁽²⁾	≤5	C3225X5R0J476MT
	16	22				1 ⁽⁴⁾	≤5	C3225X5R1C226MT
	16	10				1 ⁽⁴⁾	≤5	C3225X5R1C106MT

(4) Ceramic capacitors are recommended to complement electrolytic types at the input bus by reducing high-frequency ripple current.

TAPE AND REEL SPECIFICATION

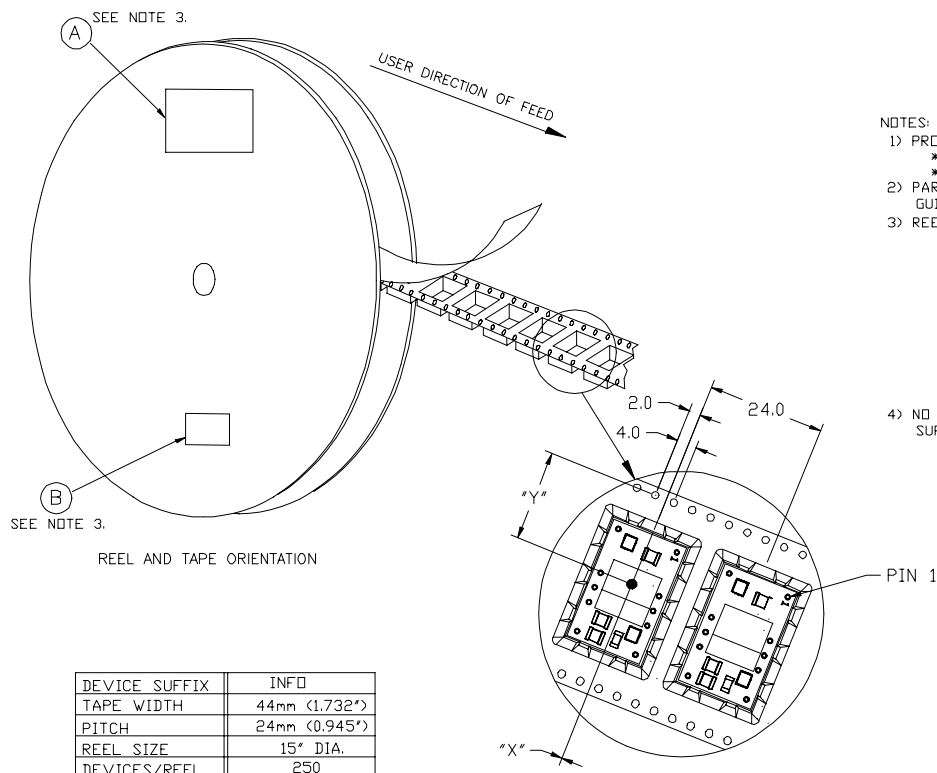

NOTES:

- 1) PROCESS IN ACCORDANCE WITH EIA-481-2
 - * TAPE LEADER DIMENSION 15.30" MIN.
 - * TAPE TRAILER DIMENSION 6.30" MIN.
- 2) PARTS SHOULD BE PACKAGED IN ACCORDANCE WITH ESD GUIDELINES IN EIA-541.
- 3) REEL LABEL: *A*- *TI PART NUMBER.
 * QUANTITY
 * DATE CODE
 * LOT NUMBER
 * MSL DATA
 * MADE IN
 * ASSY SITE ORIGIN
 * COUNTRY OF ORIGIN
 * SUPPLIER
 B- ANTI-STATIC CAUTION LABEL
- 4) NO REQUIREMENT FOR TAPE DIRECTION OF FEED FROM SUPPLIER REEL.

PTXXXX6X	*X*	*Y*
PTH03060/05060	0.0mm	18.4mm
PTH12060	0.0mm	17.9mm
PTN78060	1.2mm	21.8mm

TRAY SPECIFICATION

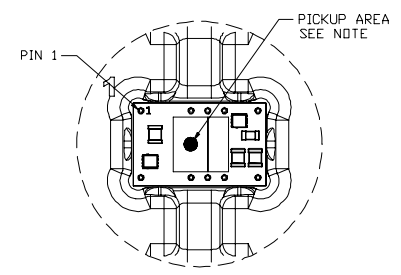
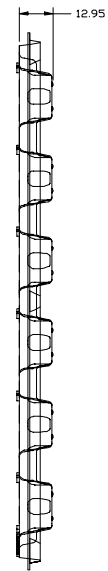
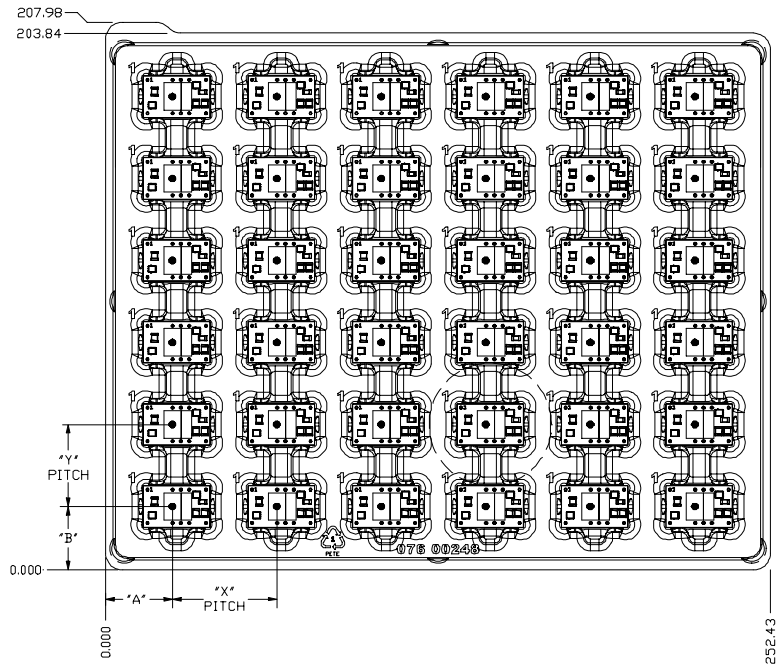

NOTE: THE INDUCTOR IS USED TO PICK AND PLACE THE MODULE. IT'S LOCATION MAY VARY FROM PACKAGE STYLE. SEE PRODUCT TABLE

PTXXX6X	"A"	"B"	"X"	"Y"
PTH03060/05060	25.46	24.13	39.52	31.12
PTH12060	24.66	24.13		
PTN78060	28.61	25.35		

ALL DIMENSIONS ARE IN MILLIMETER.

DEVICES/TRAY	36
--------------	----

PACKAGING INFORMATION

Orderable Device	Status (1)	Package Type	Package Drawing	Pins	Package Qty	Eco Plan (2)	Lead finish/ Ball material (6)	MSL Peak Temp (3)	Op Temp (°C)	Device Marking (4/5)	Samples
PTH03060YAH	ACTIVE	Through-Hole Module	EUW	10	36	RoHS Exempt & Green	SN	N / A for Pkg Type	-40 to 85		Samples
PTH03060YAST	ACTIVE	Surface Mount Module	EUY	10	250	Non-RoHS & Green	SNPB	Level-1-235C-UNLIM/ Level-3-260C-168HRS	-40 to 85		Samples
PTH03060YAZT	ACTIVE	Surface Mount Module	EUY	10	250	RoHS Exempt & Green	SNAGCU	Level-3-260C-168 HR	-40 to 85		Samples
PTH05060YAH	ACTIVE	Through-Hole Module	EUW	10	36	RoHS Exempt & Green	SN	N / A for Pkg Type	-40 to 85		Samples
PTH05060YAS	ACTIVE	Surface Mount Module	EUY	10	36	Non-RoHS & Green	SNPB	Level-1-235C-UNLIM/ Level-3-260C-168HRS	-40 to 85		Samples
PTH12060YAH	ACTIVE	Through-Hole Module	EUW	10	36	RoHS Exempt & Green	SN	N / A for Pkg Type	-40 to 85		Samples
PTH12060YAST	ACTIVE	Surface Mount Module	EUY	10	250	Non-RoHS & Green	SNPB	Level-1-235C-UNLIM/ Level-3-260C-168HRS	-40 to 85		Samples
PTH12060YAZ	ACTIVE	Surface Mount Module	EUY	10	36	RoHS Exempt & Green	SNAGCU	Level-3-260C-168 HR	-40 to 85		Samples
PTH12060YAZT	ACTIVE	Surface Mount Module	EUY	10	250	RoHS Exempt & Green	SNAGCU	Level-3-260C-168 HR	-40 to 85		Samples

(1) The marketing status values are defined as follows:

ACTIVE: Product device recommended for new designs.

LIFEBUY: TI has announced that the device will be discontinued, and a lifetime-buy period is in effect.

NRND: Not recommended for new designs. Device is in production to support existing customers, but TI does not recommend using this part in a new design.

PREVIEW: Device has been announced but is not in production. Samples may or may not be available.

OBSELETE: TI has discontinued the production of the device.

(2) **RoHS:** TI defines "RoHS" to mean semiconductor products that are compliant with the current EU RoHS requirements for all 10 RoHS substances, including the requirement that RoHS substance do not exceed 0.1% by weight in homogeneous materials. Where designed to be soldered at high temperatures, "RoHS" products are suitable for use in specified lead-free processes. TI may reference these types of products as "Pb-Free".

RoHS Exempt: TI defines "RoHS Exempt" to mean products that contain lead but are compliant with EU RoHS pursuant to a specific EU RoHS exemption.

Green: TI defines "Green" to mean the content of Chlorine (Cl) and Bromine (Br) based flame retardants meet JS709B low halogen requirements of <=1000ppm threshold. Antimony trioxide based flame retardants must also meet the <=1000ppm threshold requirement.

(3) MSL, Peak Temp. - The Moisture Sensitivity Level rating according to the JEDEC industry standard classifications, and peak solder temperature.

- (4) There may be additional marking, which relates to the logo, the lot trace code information, or the environmental category on the device.
- (5) Multiple Device Markings will be inside parentheses. Only one Device Marking contained in parentheses and separated by a "~" will appear on a device. If a line is indented then it is a continuation of the previous line and the two combined represent the entire Device Marking for that device.
- (6) Lead finish/Ball material - Orderable Devices may have multiple material finish options. Finish options are separated by a vertical ruled line. Lead finish/Ball material values may wrap to two lines if the finish value exceeds the maximum column width.

Important Information and Disclaimer:The information provided on this page represents TI's knowledge and belief as of the date that it is provided. TI bases its knowledge and belief on information provided by third parties, and makes no representation or warranty as to the accuracy of such information. Efforts are underway to better integrate information from third parties. TI has taken and continues to take reasonable steps to provide representative and accurate information but may not have conducted destructive testing or chemical analysis on incoming materials and chemicals. TI and TI suppliers consider certain information to be proprietary, and thus CAS numbers and other limited information may not be available for release.

In no event shall TI's liability arising out of such information exceed the total purchase price of the TI part(s) at issue in this document sold by TI to Customer on an annual basis.

EUW (R-PDSS-T10)

DOUBLE SIDED MODULE

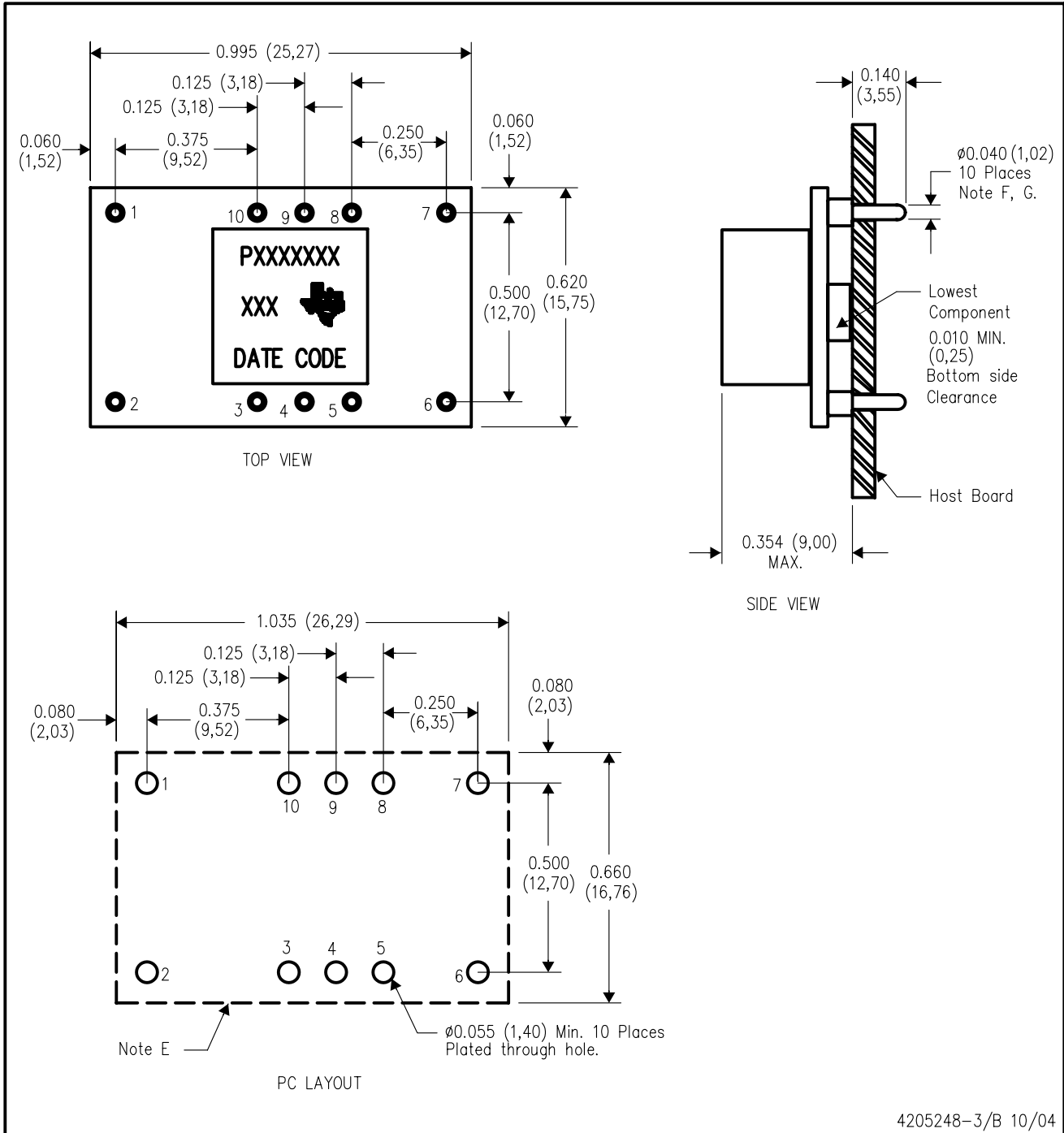

- NOTES:
- A. All linear dimensions are in inches (mm).
 - B. This drawing is subject to change without notice.
 - C. 2 place decimals are ± 0.030 (± 0.76 mm).
 - D. 3 place decimals are ± 0.010 (± 0.25 mm).
 - E. Recommended keep out area for user components

- F. Pins are 0.040" (1,02) diameter with 0.070" (1,78) diameter standoff shoulder.
- G. All pins: Material – Copper Alloy
Finish – Tin (100%) over Nickel plate

EUY (R-PDSS-B10)

DOUBLE SIDED MODULE

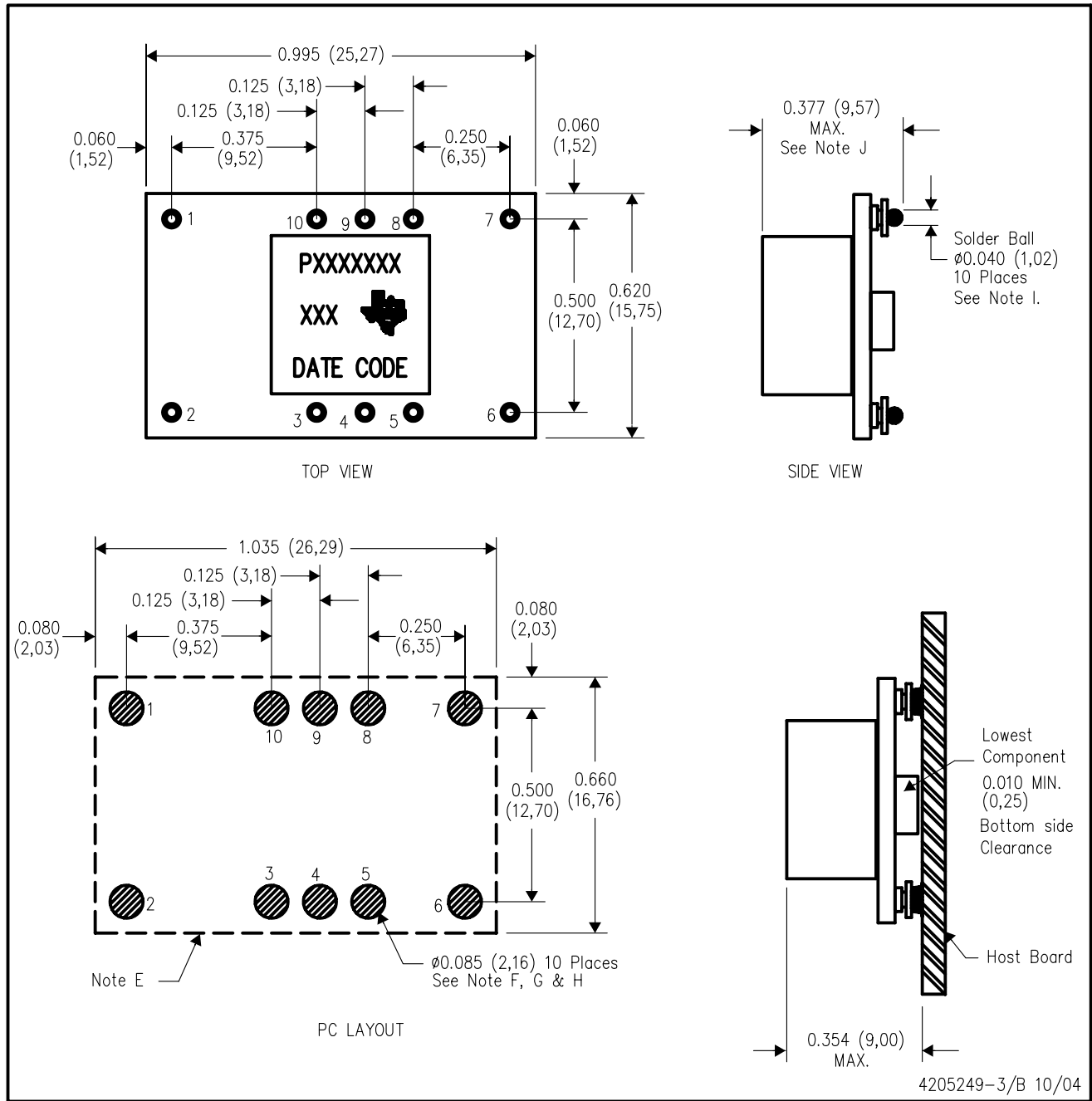

- NOTES:
- A. All linear dimensions are in inches (mm).
 - B. This drawing is subject to change without notice.
 - C. 2 place decimals are ± 0.030 ($\pm 0,76$ mm).
 - D. 3 place decimals are ± 0.010 ($\pm 0,25$ mm).
 - E. Recommended keep out area for user components.
 - F. Power pin connection should utilize two or more vias to the interior power plane of 0.025 (0,63) I.D. per input, ground and output pin (or the electrical equivalent).
 - G. Paste screen opening: 0.080 (2,03) to 0.085 (2,16).
Paste screen thickness: 0.006 (0,15).
 - H. Pad type: Solder mask defined.
 - I. All pins: Material – Copper Alloy
Finish – Tin (100%) over Nickel plate
Solder Ball – See product data sheet.
 - J. Dimension prior to reflow solder.

IMPORTANT NOTICE AND DISCLAIMER

TI PROVIDES TECHNICAL AND RELIABILITY DATA (INCLUDING DATA SHEETS), DESIGN RESOURCES (INCLUDING REFERENCE DESIGNS), APPLICATION OR OTHER DESIGN ADVICE, WEB TOOLS, SAFETY INFORMATION, AND OTHER RESOURCES "AS IS" AND WITH ALL FAULTS, AND DISCLAIMS ALL WARRANTIES, EXPRESS AND IMPLIED, INCLUDING WITHOUT LIMITATION ANY IMPLIED WARRANTIES OF MERCHANTABILITY, FITNESS FOR A PARTICULAR PURPOSE OR NON-INFRINGEMENT OF THIRD PARTY INTELLECTUAL PROPERTY RIGHTS.

These resources are intended for skilled developers designing with TI products. You are solely responsible for (1) selecting the appropriate TI products for your application, (2) designing, validating and testing your application, and (3) ensuring your application meets applicable standards, and any other safety, security, regulatory or other requirements.

These resources are subject to change without notice. TI grants you permission to use these resources only for development of an application that uses the TI products described in the resource. Other reproduction and display of these resources is prohibited. No license is granted to any other TI intellectual property right or to any third party intellectual property right. TI disclaims responsibility for, and you will fully indemnify TI and its representatives against, any claims, damages, costs, losses, and liabilities arising out of your use of these resources.

TI's products are provided subject to [TI's Terms of Sale](#) or other applicable terms available either on [ti.com](https://www.ti.com) or provided in conjunction with such TI products. TI's provision of these resources does not expand or otherwise alter TI's applicable warranties or warranty disclaimers for TI products.

TI objects to and rejects any additional or different terms you may have proposed.

Mailing Address: Texas Instruments, Post Office Box 655303, Dallas, Texas 75265
Copyright © 2023, Texas Instruments Incorporated