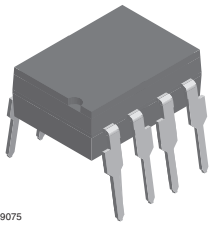
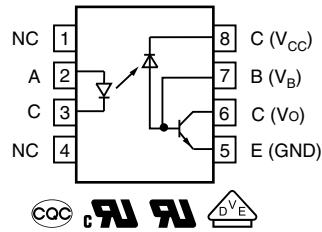


# High Speed Optocoupler, 1 MBd, Transistor Output



1179075



## FEATURES

- Isolation test voltage 5300 V<sub>RMS</sub>
- TTL compatible
- High bit rates: 1 MBit/s
- High common mode interference immunity
- Bandwidth 2 MHz
- Open collector output
- External base wiring possible
- Material categorization: for definitions of compliance please see [www.vishay.com/doc?99912](http://www.vishay.com/doc?99912)


**RoHS**  
COMPLIANT

## LINKS TO ADDITIONAL RESOURCES


**SPICE**  
Models

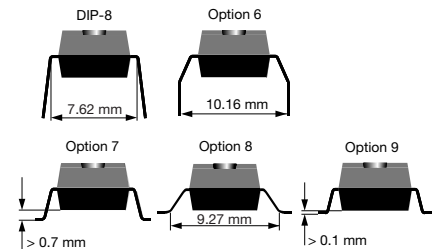
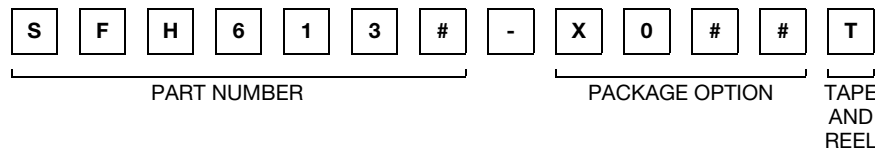
## DESCRIPTION

The SFH6135 and SFH6136 optocouplers feature a high signal transmission rate and a high isolation resistance. They have a GaAIAs infrared emitting diode, optically coupled with an integrated photo detector which consists of a photo diode and a high-speed transistor in a DIP-8 plastic package. Signals can be transmitted between two electrically separated circuits up to frequencies of 2 MHz. The potential difference between the circuits to be coupled should not exceed the maximum permissible reference voltages.

## AGENCY APPROVALS

- [UL 1577](#)
- [cUL 1577](#)
- [DIN EN 60747-5-5 \(VDE 0884-5\)](#)
- [CQC](#)

## ORDERING INFORMATION



AGENCY CERTIFIED / PACKAGE	CTR (%)	
<b>UL, cUL, CQC</b>	<b>≥ 7</b>	<b>≥ 19</b>
DIP-8	SFH6135	SFH6136
SMD-8, option 7	SFH6135-X007T	SFH6136-X007
SMD-8, option 9	-	SFH6136-X009T
<b>VDE, UL, cUL, CQC</b>	<b>≥ 7</b>	<b>≥ 19</b>
DIP-8	-	SFH6136-X001
DIP-8, 400 mil, option 6	-	SFH6136-X016
SMD-8, option 7	-	SFH6136-X017T <sup>(1)</sup>
SMD-8, option 8	-	SFH6136-X018
SMD-8, option 9	-	SFH6136-X019

### Notes

- Additional options may be possible, please contact sales office
- <sup>(1)</sup> Also available in tubes; do not add T to end



ABSOLUTE MAXIMUM RATINGS (T <sub>amb</sub> = 25 °C, unless otherwise specified)				
PARAMETER	TEST CONDITION	SYMBOL	VALUE	UNIT
<b>INPUT</b>				
Reverse voltage		V <sub>R</sub>	3	V
Forward current		I <sub>F</sub>	25	mA
Peak forward current	t = 1 ms, duty cycle 50 %	I <sub>FM</sub>	50	mA
Maximum surge forward current	t ≤ 1 μs, 300 pulses/s	I <sub>FSM</sub>	1	A
Thermal resistance		R <sub>thja</sub>	700	K/W
Power dissipation		P <sub>diss</sub>	45	mW
<b>OUTPUT</b>				
Supply voltage		V <sub>S</sub>	-0.5 to 30	V
Output voltage		V <sub>O</sub>	-0.5 to 25	V
Emitter base voltage		V <sub>EBO</sub>	5	V
Output current		I <sub>O</sub>	8	mA
Maximum output current		I <sub>O</sub>	16	mA
Base current		I <sub>B</sub>	5	mA
Thermal resistance		R <sub>thja</sub>	300	K/W
Power dissipation	T <sub>amb</sub> = 70 °C	P <sub>diss</sub>	100	mW
<b>COUPLER</b>				
Isolation test voltage		V <sub>ISO</sub>	5300	V <sub>RMS</sub>
Pollution degree (DIN VDE 0110)			2	
Isolation resistance	V <sub>IO</sub> = 500 V, T <sub>amb</sub> = 25 °C	R <sub>IO</sub>	≥ 10 <sup>12</sup>	Ω
	V <sub>IO</sub> = 500 V, T <sub>amb</sub> = 100 °C	R <sub>IO</sub>	≥ 10 <sup>11</sup>	Ω
Storage temperature range		T <sub>stg</sub>	-55 to +125	°C
Ambient temperature range		T <sub>amb</sub>	-55 to +100	°C
Soldering temperature <sup>(1)</sup>	Max. ≤ 10 s, dip soldering ≥ 0.5 mm distance from case bottom	T <sub>slid</sub>	260	°C

**Notes**

- Stresses in excess of the absolute maximum ratings can cause permanent damage to the device. Functional operation of the device is not implied at these or any other conditions in excess of those given in the operational sections of this document. Exposure to absolute maximum ratings for extended periods of the time can adversely affect reliability

<sup>(1)</sup> Refer to wave profile for soldering conditions for through hole devices

ELECTRICAL CHARACTERISTICS (T <sub>amb</sub> = 25 °C, unless otherwise specified)							
PARAMETER	TEST CONDITION	PART	SYMBOL	MIN.	TYP.	MAX.	UNIT
<b>INPUT</b>							
Forward voltage	I <sub>F</sub> = 16 mA		V <sub>F</sub>	-	1.6	1.9	V
Breakdown voltage	I <sub>R</sub> = 10 μA		V <sub>BR</sub>	3	-	-	V
Reverse current	V <sub>R</sub> = 3 V		I <sub>R</sub>	-	0.5	10	μA
Capacitance	V <sub>R</sub> = 0 V, f = 1 MHz		C <sub>O</sub>	-	125	-	pF
Temperature coefficient of forward voltage	I <sub>F</sub> = 16 mA		ΔV <sub>F</sub> /ΔT <sub>amb</sub>	-	1.7	-	mV/°C
<b>OUTPUT</b>							
Logic low supply current	I <sub>F</sub> = 16 mA, V <sub>O</sub> = open, V <sub>CC</sub> = 15 V		I <sub>CCL</sub>	-	150	-	μA
Logic high supply current	I <sub>F</sub> = 0 V, V <sub>O</sub> = open, V <sub>CC</sub> = 15 V		I <sub>CCH</sub>	-	0.01	1	μA
Output voltage, output low	I <sub>F</sub> = 16 mA, V <sub>CC</sub> = 4.5 V, I <sub>O</sub> = 1.1 mA	SFH6135	V <sub>OL</sub>	-	0.1	0.4	V
	I <sub>F</sub> = 16 mA, V <sub>CC</sub> = 4.5 V, I <sub>O</sub> = 2.4 mA	SFH6136	V <sub>OL</sub>	-	0.1	0.4	V
Output current, output high	I <sub>F</sub> = 0 mA, V <sub>O</sub> = V <sub>CC</sub> = 5.5 V		I <sub>OH</sub>	-	3	500	nA
	I <sub>F</sub> = 0 mA, V <sub>O</sub> = V <sub>CC</sub> = 15 V		I <sub>OH</sub>	-	0.01	1	μA

ELECTRICAL CHARACTERISTICS ( $T_{amb} = 25\text{ }^{\circ}\text{C}$ , unless otherwise specified)							
PARAMETER	TEST CONDITION	PART	SYMBOL	MIN.	TYP.	MAX.	UNIT
<b>COUPLER</b>							
Capacitance (input to output)	$f = 1\text{ MHz}$		$C_{IO}$	-	0.6	-	pF

**Note**

- Minimum and maximum values are testing requirements. Typical values are characteristics of the device and are the result of engineering evaluation. Typical values are for information only and are not part of the testing requirements

CURRENT TRANSFER RATIO							
PARAMETER	TEST CONDITION	PART	SYMBOL	MIN.	TYP.	MAX.	UNIT
Current transfer ratio	$I_F = 16\text{ mA}$ , $V_O = 0.4\text{ V}$ , $V_{CC} = 4.5\text{ V}$	SFH6135	CTR	7	16	-	%
		SFH6136	CTR	19	35	-	%
	$I_F = 16\text{ mA}$ , $V_O = 0.5\text{ V}$ , $V_{CC} = 4.5\text{ V}$	SFH6135	CTR	5	-	-	%
		SFH6136	CTR	15	-	-	%

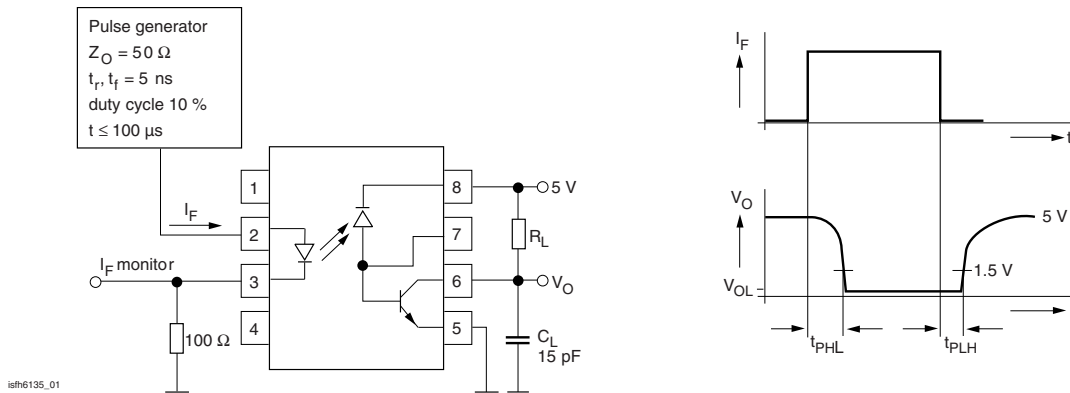


Fig. 1 - Schematics

SWITCHING CHARACTERISTICS							
PARAMETER	TEST CONDITION	PART	SYMBOL	MIN.	TYP.	MAX.	UNIT
High to low	$I_F = 16\text{ mA}$ , $V_{CC} = 5\text{ V}$ , $R_L = 4.1\text{ k}\Omega$	SFH6135	$t_{PHL}$	-	0.3	1.5	$\mu\text{s}$
	$I_F = 16\text{ mA}$ , $V_{CC} = 5\text{ V}$ , $R_L = 1.9\text{ k}\Omega$	SFH6136	$t_{PHL}$	-	0.2	0.8	$\mu\text{s}$
Low to high	$I_F = 16\text{ mA}$ , $V_{CC} = 5\text{ V}$ , $R_L = 4.1\text{ k}\Omega$	SFH6135	$t_{PLH}$	-	0.3	1.5	$\mu\text{s}$
	$I_F = 16\text{ mA}$ , $V_{CC} = 5\text{ V}$ , $R_L = 1.9\text{ k}\Omega$	SFH6136	$t_{PLH}$	-	0.2	0.8	$\mu\text{s}$

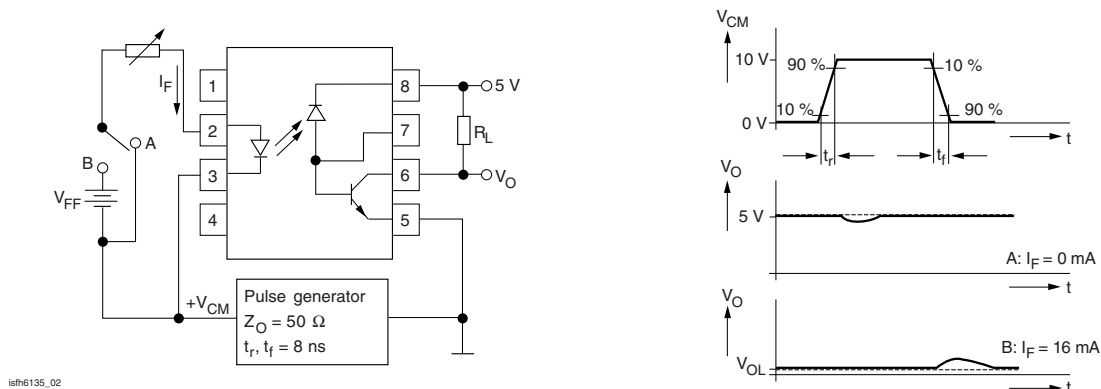


Fig. 1 - Common Mode Interference Immunity

COMMON MODE TRANSIENT IMMUNITY							
PARAMETER	TEST CONDITION	PART	SYMBOL	MIN.	TYP.	MAX.	UNIT
High	$V_{CM} = 10 V_{P-P}$ , $V_{CC} = 5 V$ , $I_F = 0 mA$ , $R_L = 4.1 k\Omega$	SFH6135	CM <sub>H</sub>	-	1000	-	V/ $\mu$ s
	$V_{CM} = 10 V_{P-P}$ , $V_{CC} = 5 V$ , $I_F = 0 mA$ , $R_L = 1.9 k\Omega$	SFH6136	CM <sub>H</sub>	-	1000	-	V/ $\mu$ s
Low	$V_{CM} = 10 V_{P-P}$ , $V_{CC} = 5 V$ , $I_F = 0 mA$ , $R_L = 4.1 k\Omega$	SFH6135	CM <sub>L</sub>	-	1000	-	V/ $\mu$ s
	$V_{CM} = 10 V_{P-P}$ , $V_{CC} = 5 V$ , $I_F = 0 mA$ , $R_L = 1.9 k\Omega$	SFH6136	CM <sub>L</sub>	-	1000	-	V/ $\mu$ s

SAFETY AND INSULATION RATINGS						
PARAMETER	TEST CONDITION	SYMBOL	MIN.	TYP.	MAX.	UNIT
Climatic classification (according to IEC 68 part 1)			-	55 / 100 / 21	-	
Comparative tracking index		CTI	175	-	399	
$V_{IOTM}$			8000	-	-	V
$V_{IORM}$			890	-	-	V
$P_{SO}$			-	-	500	mW
$I_{SI}$			-	-	300	mA
$T_{SI}$			-	-	175	$^{\circ}C$
Creepage distance	Standard DIP-8		7	-	-	mm
Clearance distance	Standard DIP-8		7	-	-	mm
Creepage distance	400 mil DIP-8		8	-	-	mm
Clearance distance	400 mil DIP-8		8	-	-	mm

**Note**

- As per IEC 60747-5-5, §7.4.3.8.1, this optocoupler is suitable for “safe electrical insulation” only within the safety ratings. Compliance with the safety ratings shall be ensured by means of protective circuits

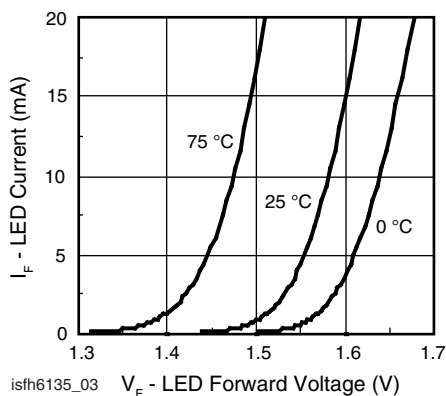
**TYPICAL CHARACTERISTICS** ( $T_{amb} = 25^{\circ}C$ , unless otherwise specified)


Fig. 3 - LED Forward Current vs. Forward Voltage

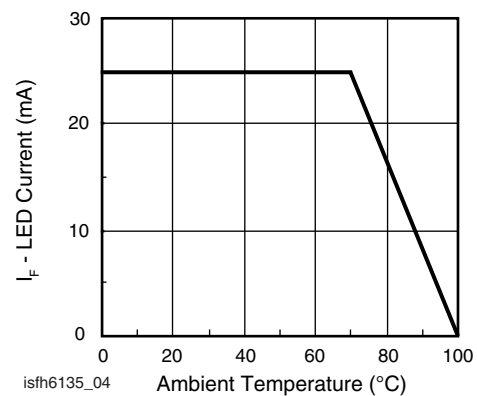


Fig. 4 - Permissible Forward LED Current vs. Temperature

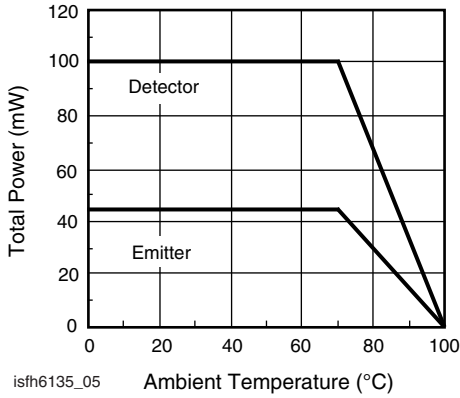


Fig. 5 - Permissible Power Dissipation vs. Temperature

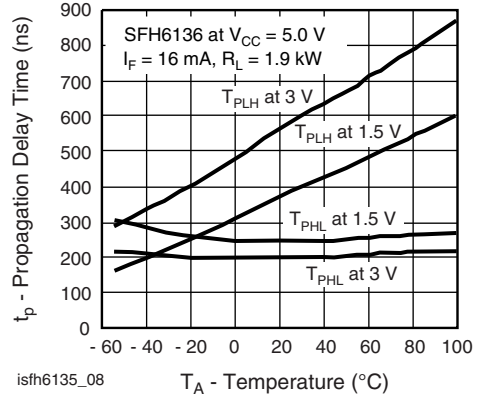


Fig. 8 - Propagation Delay vs. Ambient Temperature - SFH6136

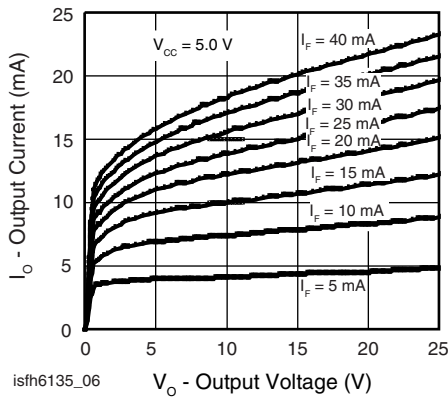


Fig. 6 - Output Current vs. Output Voltage

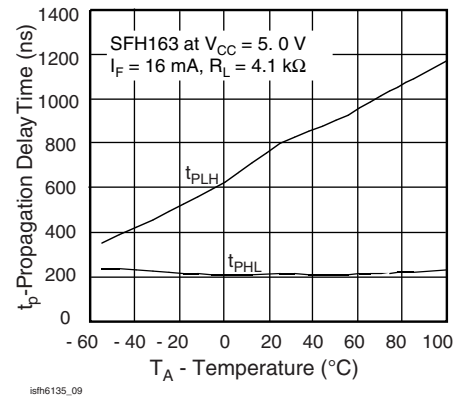


Fig. 9 - Propagation Delay vs. Ambient Temperature - SFH6135

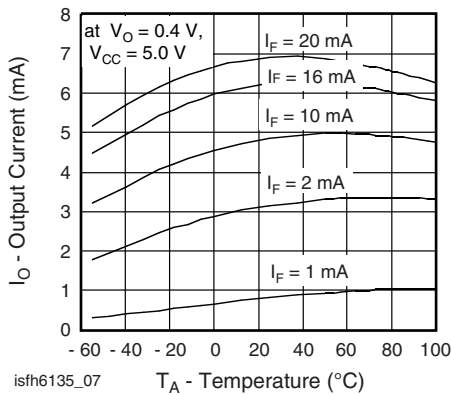


Fig. 7 - Output Current vs. Temperature

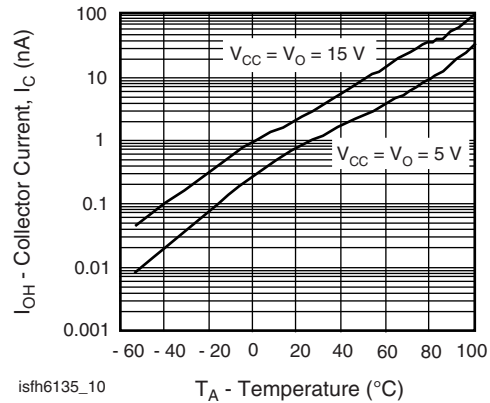


Fig. 10 - Logic High Output Current vs. Temperature

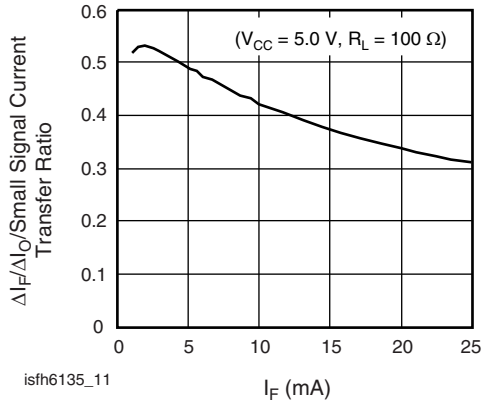
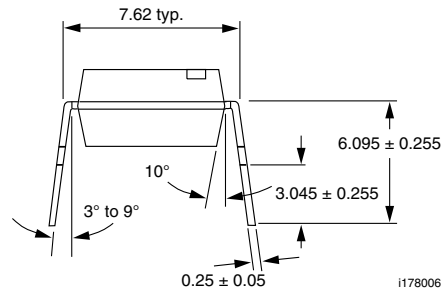
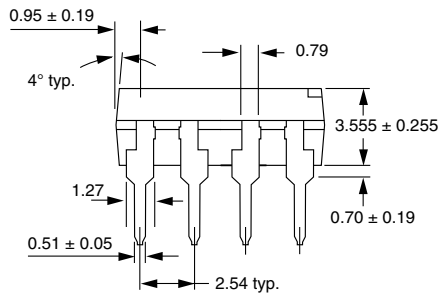
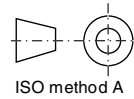
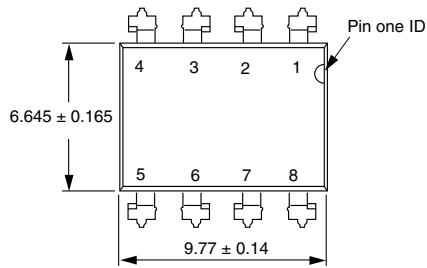


Fig. 11 - Small Signal Current Transfer Ratio vs. Quiescent Input Current

### PACKAGE DIMENSIONS in millimeters

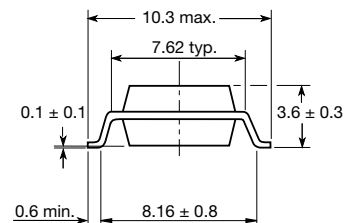
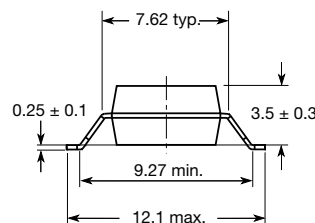
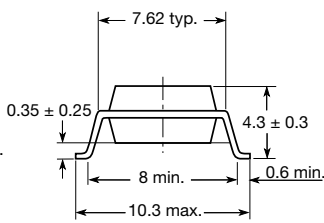
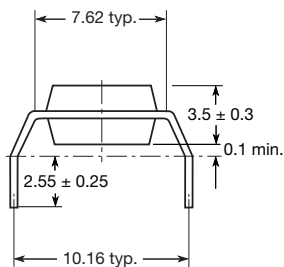


Option 6

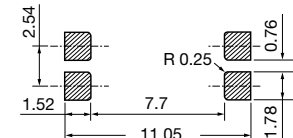
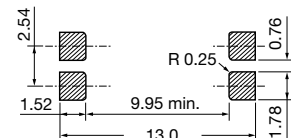
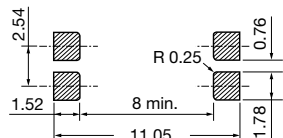
Option 7

Option 8

Option 9

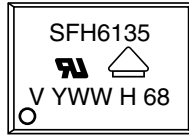


20802-1





**PACKAGE MARKING**



21764-66



## Disclaimer

ALL PRODUCT, PRODUCT SPECIFICATIONS AND DATA ARE SUBJECT TO CHANGE WITHOUT NOTICE TO IMPROVE RELIABILITY, FUNCTION OR DESIGN OR OTHERWISE.

Vishay Intertechnology, Inc., its affiliates, agents, and employees, and all persons acting on its or their behalf (collectively, "Vishay"), disclaim any and all liability for any errors, inaccuracies or incompleteness contained in any datasheet or in any other disclosure relating to any product.

Vishay makes no warranty, representation or guarantee regarding the suitability of the products for any particular purpose or the continuing production of any product. To the maximum extent permitted by applicable law, Vishay disclaims (i) any and all liability arising out of the application or use of any product, (ii) any and all liability, including without limitation special, consequential or incidental damages, and (iii) any and all implied warranties, including warranties of fitness for particular purpose, non-infringement and merchantability.

Statements regarding the suitability of products for certain types of applications are based on Vishay's knowledge of typical requirements that are often placed on Vishay products in generic applications. Such statements are not binding statements about the suitability of products for a particular application. It is the customer's responsibility to validate that a particular product with the properties described in the product specification is suitable for use in a particular application. Parameters provided in datasheets and / or specifications may vary in different applications and performance may vary over time. All operating parameters, including typical parameters, must be validated for each customer application by the customer's technical experts. Product specifications do not expand or otherwise modify Vishay's terms and conditions of purchase, including but not limited to the warranty expressed therein.

Hyperlinks included in this datasheet may direct users to third-party websites. These links are provided as a convenience and for informational purposes only. Inclusion of these hyperlinks does not constitute an endorsement or an approval by Vishay of any of the products, services or opinions of the corporation, organization or individual associated with the third-party website. Vishay disclaims any and all liability and bears no responsibility for the accuracy, legality or content of the third-party website or for that of subsequent links.

Except as expressly indicated in writing, Vishay products are not designed for use in medical, life-saving, or life-sustaining applications or for any other application in which the failure of the Vishay product could result in personal injury or death. Customers using or selling Vishay products not expressly indicated for use in such applications do so at their own risk. Please contact authorized Vishay personnel to obtain written terms and conditions regarding products designed for such applications.

No license, express or implied, by estoppel or otherwise, to any intellectual property rights is granted by this document or by any conduct of Vishay. Product names and markings noted herein may be trademarks of their respective owners.