

High Speed Optocoupler, Dual Channel, 1 MBd, Transistor Output

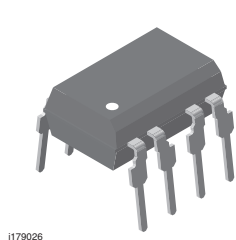

1179026

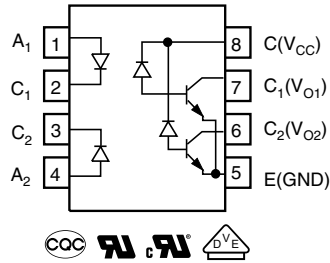

FEATURES

- Isolation test voltage, 5300 V_{RMS}
- TTL compatible
- Bit rates: 1 MBit/s
- High common mode transient immunity
- Bandwidth 2 MHz
- Open collector output
- Material categorization: for definitions of compliance please see www.vishay.com/doc?99912

RoHS
COMPLIANT

LINKS TO ADDITIONAL RESOURCES



DESCRIPTION

The SFH6325 and SFH6326 are dual channel optocouplers with a GaAlAs infrared emitting diode, optically coupled with an integrated photo detector which consists of a photo diode and a high-speed transistor in a DIP-8 plastic package. Signals can be transmitted between two electrically separated circuits up to frequencies of 2 MHz. The potential difference between the circuits to be coupled should not exceed the maximum permissible reference voltages.

AGENCY APPROVALS

- [UL](#)
- [cUL](#)
- [DIN EN 60747-5-5 \(VDE 0884-5\)](#), available with option 1
- [CQC](#)

ORDERING INFORMATION		
<div style="display: flex; justify-content: space-around; align-items: center;"> <div style="border: 1px solid black; padding: 2px 5px; margin: 2px;">S</div> <div style="border: 1px solid black; padding: 2px 5px; margin: 2px;">F</div> <div style="border: 1px solid black; padding: 2px 5px; margin: 2px;">H</div> <div style="border: 1px solid black; padding: 2px 5px; margin: 2px;">6</div> <div style="border: 1px solid black; padding: 2px 5px; margin: 2px;">3</div> <div style="border: 1px solid black; padding: 2px 5px; margin: 2px;">2</div> <div style="border: 1px solid black; padding: 2px 5px; margin: 2px;">#</div> <div style="border: 1px solid black; padding: 2px 5px; margin: 2px;">-</div> <div style="border: 1px solid black; padding: 2px 5px; margin: 2px;">X</div> <div style="border: 1px solid black; padding: 2px 5px; margin: 2px;">0</div> <div style="border: 1px solid black; padding: 2px 5px; margin: 2px;">#</div> <div style="border: 1px solid black; padding: 2px 5px; margin: 2px;">#</div> <div style="border: 1px solid black; padding: 2px 5px; margin: 2px;">T</div> </div> <p style="text-align: center; margin-top: 5px;"> PART NUMBER PACKAGE OPTION TAPE AND REEL </p>		
AGENCY CERTIFIED / PACKAGE	CTR (%)	
UL, cUL, CQC	≥ 7	≥ 19
SMD-8, option 7	-	SFH6326-X007T ⁽¹⁾
SMD-8, option 9	SFH6325-X009T	SFH6326-X009T ⁽¹⁾
UL, cUL, CQC, VDE (option 1)	≥ 7	≥ 19
DIP-8	-	SFH6326-X001
SMD-8, option 7	SFH6325-X017T	SFH6326-X017T ⁽¹⁾

Notes

- Additional options may be possible, please contact sales office
- ⁽¹⁾ Also available in tubes; do not add T to end



ABSOLUTE MAXIMUM RATINGS ($T_{amb} = 25\text{ }^{\circ}\text{C}$, unless otherwise specified)				
PARAMETER	TEST CONDITION	SYMBOL	VALUE	UNIT
INPUT				
Reverse voltage		V_R	4.5	V
Forward continuous current		I_F	25	mA
Peak forward current	$t = 1\text{ ms}$, duty cycle 50 %	I_{FM}	50	mA
Maximum surge forward current	$t \leq 1\text{ }\mu\text{s}$, 300 pulses/s	I_{FSM}	1	A
Derate linearly from 25 °C			0.6	mW/°C
Power dissipation	$T_{amb} \leq 70\text{ }^{\circ}\text{C}$	P_{diss}	50	mW
OUTPUT				
Supply voltage		V_S	-0.5 to 30	V
Output voltage		V_O	-0.5 to 25	V
Collector output current		I_{CO}	8	mA
Derate linearly from 25 °C			1.33	mW/°C
Power dissipation	$T_{amb} \leq 70\text{ }^{\circ}\text{C}$	P_{diss}	50	mW
COUPLER				
Isolation test voltage	$t = 1\text{ min}$	V_{ISO}	5300	V_{RMS}
Pollution degree (DIN VDE0109)			2	
Creepage distance			≥ 8	mm
Clearance distance			≥ 8	mm
Derate linearly from 25 °C			1.93	mW/°C
Total package dissipation		P_{tot}	145	mW
Comparative tracking index per DIN IEC112/VDE0303 part 1, group IIIa per DIN VDE6110			175	
Isolation resistance	$V_{IO} = 500\text{ V}$, $T_{amb} = 25\text{ }^{\circ}\text{C}$	R_{IO}	$\geq 10^{12}$	Ω
	$V_{IO} = 500\text{ V}$, $T_{amb} = 100\text{ }^{\circ}\text{C}$	R_{IO}	$\geq 10^{11}$	Ω
Storage temperature range		T_{stg}	-55 to +150	°C
Ambient temperature range		T_{amb}	-55 to +100	°C
Soldering temperature ⁽¹⁾	max. 10 s, dip soldering distance to seating plane $\geq 1.5\text{ mm}$	T_{sld}	260	°C

Notes

- Stresses in excess of the absolute maximum ratings can cause permanent damage to the device. Functional operation of the device is not implied at these or any other conditions in excess of those given in the operational sections of this document. Exposure to absolute maximum ratings for extended periods of the time can adversely affect reliability.
- ⁽¹⁾ Refer to reflow profile for soldering conditions for surface mounted devices (SMD). Refer to wave profile for soldering conditions for through hole devices (DIP).



ELECTRICAL CHARACTERISTICS							
PARAMETER	TEST CONDITION	PART	SYMBOL	MIN.	TYP.	MAX.	UNIT
INPUT							
Forward voltage	$I_F = 16 \text{ mA}$		V_F	-	1.33	1.9	V
Breakdown voltage	$I_R = 10 \text{ }\mu\text{A}$		V_{BR}	4.5	-	-	V
Reverse current	$V_R = 4.5 \text{ V}$		I_R	-	0.5	10	μA
Capacitance	$V_R = 0 \text{ V}, f = 1 \text{ MHz}$		C_O	-	30	-	pF
Temperature coefficient of forward voltage	$I_F = 16 \text{ mA}$		$\Delta V_F / \Delta T_{amb}$	-	-1.7	-	mV/°C
OUTPUT							
Logic low supply current	$I_F = 16 \text{ mA}, V_O = \text{open}, V_{CC} = 4.5 \text{ V}$		I_{CCL}	-	100	200	μA
Supply current, logic high	$I_F = 0 \text{ mA}, V_O = \text{open}, V_{CC} = 15 \text{ V}$		I_{CCH}	-	0.01	4	μA
Logic low output voltage	$I_F = 16 \text{ mA}, V_{CC} = 4.5 \text{ V}, I_O = 1.1 \text{ mA}$	SFH6325	V_{OL}	-	0.1	0.5	V
	$I_F = 16 \text{ mA}, V_{CC} = 4.5 \text{ V}, I_O = 3 \text{ mA}$	SFH6326	V_{OL}	-	0.1	0.5	V
Logic high output current	$I_F = 0 \text{ mA}, V_O = V_{CC} = 5.5 \text{ V}$		I_{OH}	-	3	500	nA
	$I_F = 0 \text{ mA}, V_O = V_{CC} = 15 \text{ V}$		I_{OH}	-	-	50	μA
Channel to channel ⁽¹⁾ crosstalk	$I_F = 16 \text{ mA}, V_O = V_{CC} = 5.5 \text{ V}$		I_{OH-XT}	-	-	500	nA
COUPLER							
Capacitance (input to output)	$f = 1 \text{ MHz}$		C_{IO}	-	0.6	-	pF

Notes

- $T_{amb} = 0 \text{ }^\circ\text{C}$ to $70 \text{ }^\circ\text{C}$, unless otherwise specified, typical values $T_{amb} = 25 \text{ }^\circ\text{C}$
 - Minimum and maximum values are testing requirements. Typical values are characteristics of the device and are the result of engineering evaluation. Typical values are for information only and are not part of the testing requirements
- ⁽¹⁾ To measure crosstalk, turn on the LED for channel 1 and the output current for channel 2 in logic high. Repeat for channel 2

CURRENT TRANSFER RATIO ($T_{amb} = 25 \text{ }^\circ\text{C}$, unless otherwise specified)							
PARAMETER	TEST CONDITION	PART	SYMBOL	MIN.	TYP.	MAX.	UNIT
Current transfer ratio	$I_F = 16 \text{ mA}, V_{CC} = 4.5 \text{ V}, V_O = 0.4 \text{ V}, T_{amb} = 25 \text{ }^\circ\text{C}$	SFH6325	CTR	7	16	-	%
		SFH6326	CTR	19	35	-	%
	$I_F = 16 \text{ mA}, V_{CC} = 4.5 \text{ V}, V_O = 0.5 \text{ V}, T_{amb} = 0 \text{ }^\circ\text{C}$ to $70 \text{ }^\circ\text{C}$	SFH6325	CTR	5	-	-	%
		SFH6326	CTR	15	-	-	%

SWITCHING CHARACTERISTICS ($T_{amb} = 25 \text{ }^\circ\text{C}$, unless otherwise specified)							
PARAMETER	TEST CONDITION	PART	SYMBOL	MIN.	TYP.	MAX.	UNIT
High to low	$I_F = 16 \text{ mA}, V_{CC} = 5 \text{ V}, R_L = 4.1 \text{ k}\Omega$	SFH6325	t_{PHL}	-	0.3	1.5	μs
	$I_F = 16 \text{ mA}, V_{CC} = 5 \text{ V}, R_L = 1.9 \text{ k}\Omega$	SFH6326	t_{PHL}	-	0.2	0.8	μs
Low to high	$I_F = 16 \text{ mA}, V_{CC} = 5 \text{ V}, R_L = 4.1 \text{ k}\Omega$	SFH6325	t_{PLH}	-	0.6	1.5	μs
	$I_F = 16 \text{ mA}, V_{CC} = 5 \text{ V}, R_L = 1.9 \text{ k}\Omega$	SFH6326	t_{PLH}	-	0.5	0.8	μs

COMMON MODE TRANSIENT IMMUNITY ($T_{amb} = 25 \text{ }^\circ\text{C}$, unless otherwise specified)							
PARAMETER	TEST CONDITION	PART	SYMBOL	MIN.	TYP.	MAX.	UNIT
CMTI at logic high level output	$I_F = 0 \text{ mA}, C_{CM} = 10 \text{ V}_{P-P}, V_{CC} = 5 \text{ V}, R_L = 4.1 \text{ k}\Omega$	SFH6325	CM_H	-	1000	-	V/ μs
	$I_F = 0 \text{ mA}, C_{CM} = 10 \text{ V}_{P-P}, V_{CC} = 5 \text{ V}, R_L = 1.9 \text{ k}\Omega$	SFH6326	CM_H	-	1000	-	V/ μs
CMTI at logic low level output	$I_F = 16 \text{ mA}, C_{CM} = 10 \text{ V}_{P-P}, V_{CC} = 5 \text{ V}, R_L = 4.1 \text{ k}\Omega$	SFH6325	CM_L	-	1000	-	V/ μs
	$I_F = 16 \text{ mA}, C_{CM} = 10 \text{ V}_{P-P}, V_{CC} = 5 \text{ V}, R_L = 1.9 \text{ k}\Omega$	SFH6326	CM_L	-	1000	-	V/ μs

TYPICAL CHARACTERISTICS ($T_{amb} = 25\text{ }^{\circ}\text{C}$, unless otherwise specified)

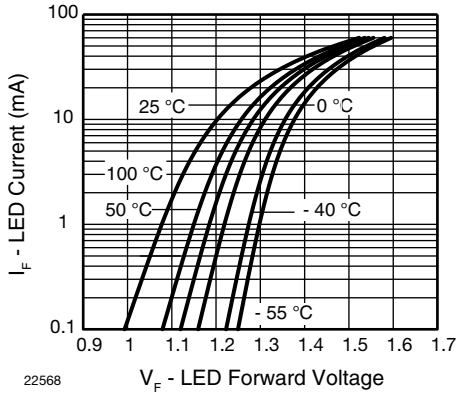

Fig. 1 - LED Forward Current vs. Forward Voltage

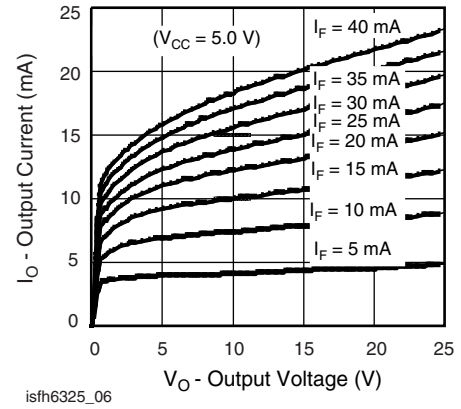

Fig. 4 - Output Current vs. Output Voltage

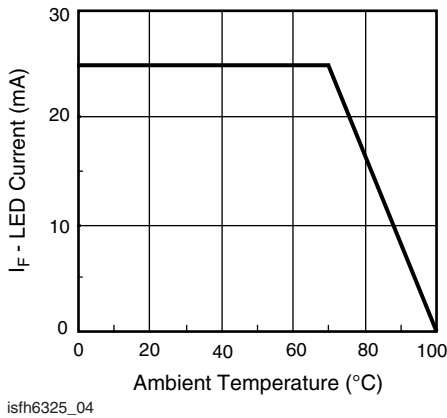

Fig. 2 - Permissible Forward LED Current vs. Temperature

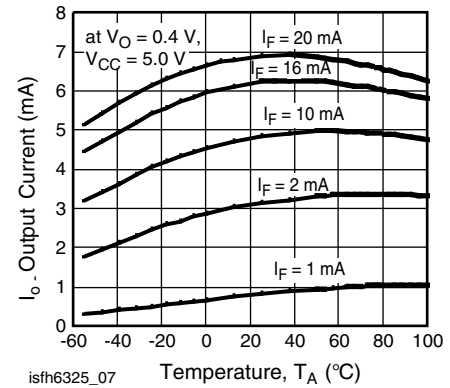

Fig. 5 - Output Current vs. Temperature

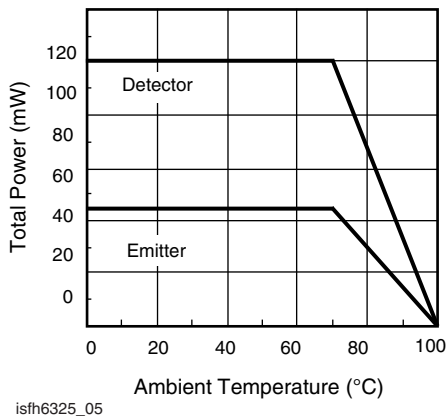

Fig. 3 - Permissible Power Dissipation vs. Temperature

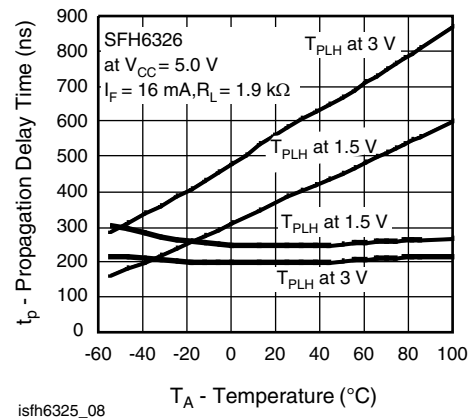

Fig. 6 - Propagation Delay vs. Ambient Temperature

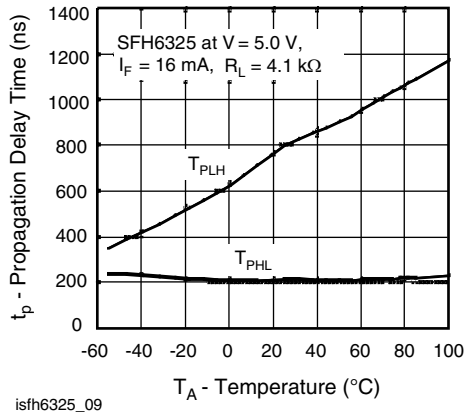

Fig. 7 - Propagation Delay vs. Ambient Temperature

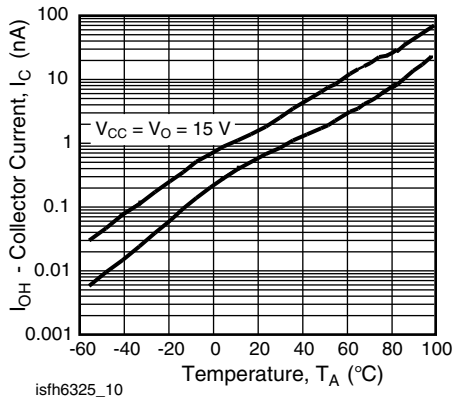

Fig. 8 - Logic High Output Current vs. Temperature

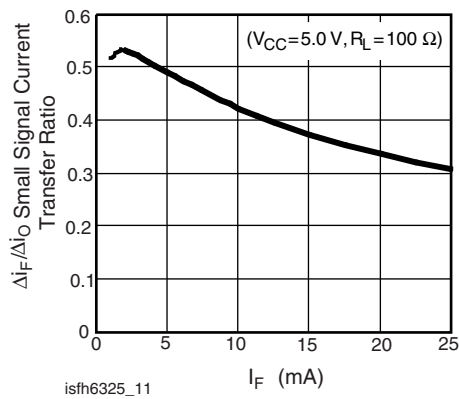

Fig. 9 - Small Signal Current Transfer Ratio vs. Input Current

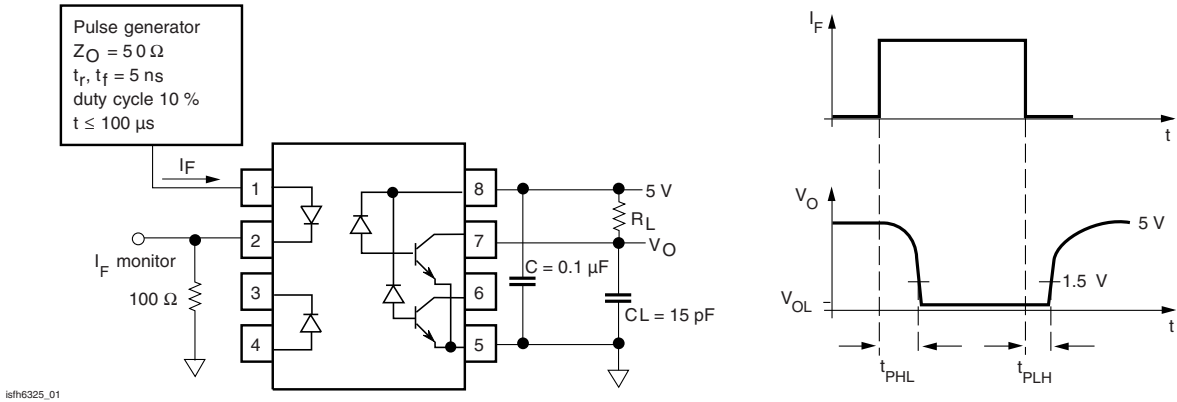

Fig. 10 - Switching Time and Test Circuit

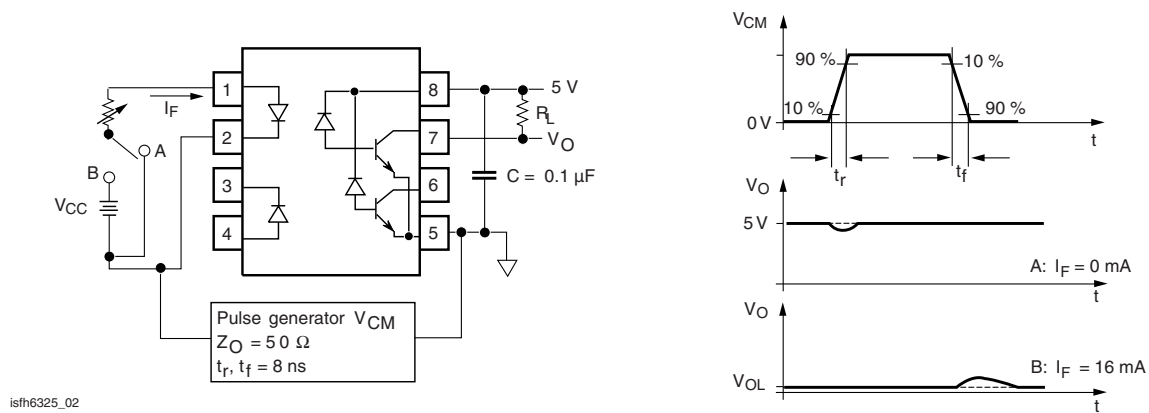
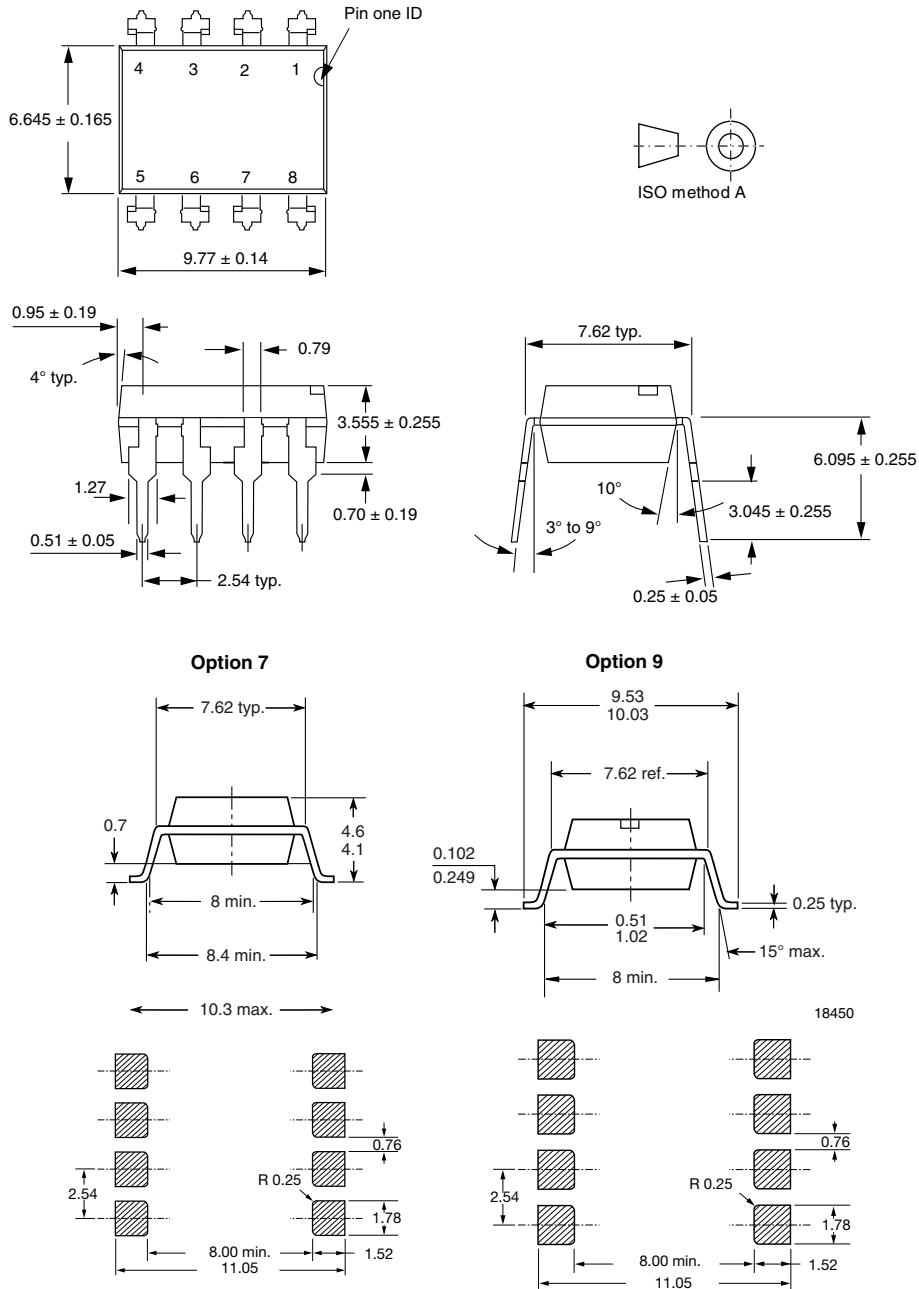
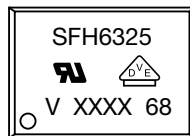

Fig. 11 - Waveform and Test Circuit for Common Mode Transient Immunity

PACKAGE DIMENSIONS in millimeters



PACKAGE MARKING (example)



Notes

- XXXX = LMC (lot marking code)
- The VDE Logo is only marked on option1 parts
- Tape and reel suffix (T) is not part of the package marking



Disclaimer

ALL PRODUCT, PRODUCT SPECIFICATIONS AND DATA ARE SUBJECT TO CHANGE WITHOUT NOTICE TO IMPROVE RELIABILITY, FUNCTION OR DESIGN OR OTHERWISE.

Vishay Intertechnology, Inc., its affiliates, agents, and employees, and all persons acting on its or their behalf (collectively, "Vishay"), disclaim any and all liability for any errors, inaccuracies or incompleteness contained in any datasheet or in any other disclosure relating to any product.

Vishay makes no warranty, representation or guarantee regarding the suitability of the products for any particular purpose or the continuing production of any product. To the maximum extent permitted by applicable law, Vishay disclaims (i) any and all liability arising out of the application or use of any product, (ii) any and all liability, including without limitation special, consequential or incidental damages, and (iii) any and all implied warranties, including warranties of fitness for particular purpose, non-infringement and merchantability.

Statements regarding the suitability of products for certain types of applications are based on Vishay's knowledge of typical requirements that are often placed on Vishay products in generic applications. Such statements are not binding statements about the suitability of products for a particular application. It is the customer's responsibility to validate that a particular product with the properties described in the product specification is suitable for use in a particular application. Parameters provided in datasheets and / or specifications may vary in different applications and performance may vary over time. All operating parameters, including typical parameters, must be validated for each customer application by the customer's technical experts. Product specifications do not expand or otherwise modify Vishay's terms and conditions of purchase, including but not limited to the warranty expressed therein.

Hyperlinks included in this datasheet may direct users to third-party websites. These links are provided as a convenience and for informational purposes only. Inclusion of these hyperlinks does not constitute an endorsement or an approval by Vishay of any of the products, services or opinions of the corporation, organization or individual associated with the third-party website. Vishay disclaims any and all liability and bears no responsibility for the accuracy, legality or content of the third-party website or for that of subsequent links.

Except as expressly indicated in writing, Vishay products are not designed for use in medical, life-saving, or life-sustaining applications or for any other application in which the failure of the Vishay product could result in personal injury or death. Customers using or selling Vishay products not expressly indicated for use in such applications do so at their own risk. Please contact authorized Vishay personnel to obtain written terms and conditions regarding products designed for such applications.

No license, express or implied, by estoppel or otherwise, to any intellectual property rights is granted by this document or by any conduct of Vishay. Product names and markings noted herein may be trademarks of their respective owners.