

High Speed Optocoupler, 10 MBd, Dual, SOIC-8 Package

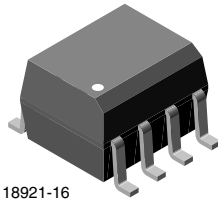

18921-16

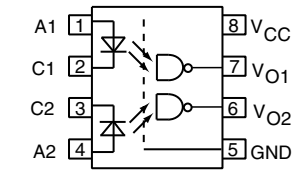

18921-24



20050

FEATURES

- Choice of CMR performance of 15 kV/μs, 5 kV/μs, and 100 V/μs
- External creepage distance > 5 mm
- High speed: 10 Mbd typical
- + 5 V CMOS compatibility
- Guaranteed AC and DC performance over temperature: - 40 °C to + 100 °C temperature range
- Pure tin leads
- Meets IEC 60068-2-42 (SO₂) and IEC 60068-2-43 (H₂S) requirements
- Low input current capability: 5 mA
- Material categorization: for definitions of compliance please see www.vishay.com/doc?99912

RoHS
COMPLIANT

LINKS TO ADDITIONAL RESOURCES



DESCRIPTION

The SFH675xT-series, is a dual channel 10 MBD optocoupler utilizing a high efficient input LED coupled with an integrated optical photodiode IC detector. The detector has an open drain NMOS-transistor output, providing less leakage compared to an open collector Schottky clamped transistor output. The internal shield provides a guaranteed common mode transient immunity of 5 kV/μs for the SFH6756T and 15 kV/μs for the SFH6757T. The use of a 0.1 μF bypass capacitor connected between pin 5 and 8 is recommended.

AGENCY APPROVALS

- [UL](#)
- [cUL](#)
- [DIN EN 60747-5-5 \(VDE 0884-5\)](#), available with option 1

APPLICATIONS

- Microprocessor system interface
- PLC, ATE input/output isolation
- Computer peripheral interface
- Digital fieldbus isolation: CC-link, DeviceNet, profibus, SDS
- High speed A/D and D/A conversion
- AC plasma display panel level shifting
- Multiplexed data transmission
- Digital control power supply
- Ground loop elimination

ORDERING INFORMATION			
S	F	H	6
7	5	#	T
PART NUMBER			TAPE AND REEL
AGENCY CERTIFIED / PACKAGE	CMR (kV/μs)	CMR (kV/μs)	CMR (kV/μs)
UL, cUL	0.1	5	15
SOIC-8	SFH6755T	SFH6756T	SFH6757T



TRUTH TABLE (positive logic)		
LED	ENABLE	OUTPUT
On	H	L
Off	H	H
On	L	H
Off	L	H
On	NC	L
Off	NC	H

ABSOLUTE MAXIMUM RATINGS ($T_{amb} = 25\text{ }^{\circ}\text{C}$, unless otherwise specified)				
PARAMETER	TEST CONDITION	SYMBOL	VALUE	UNIT
INPUT				
Average forward current (single channel)		I_F	20	mA
Average forward current (per channel for dual channel)		I_F	15	mA
Reverse input voltage		V_R	5	V
Surge current	$t = 100\text{ }\mu\text{s}$	I_{FSM}	200	mA
Output power dissipation (single channel)		P_{diss}	35	mW
Output power dissipation (per channel for dual channel)		P_{diss}	25	mW
OUTPUT				
Supply voltage	1 min maximum	V_{CC}	7	V
Output current		I_O	50	mA
Output voltage		V_O	7	V
Output power dissipation (single channel)		P_{diss}	85	mW
Output power dissipation (for dual channel)		P_{diss}	60	mW
COUPLER				
Isolation test voltage	$t = 1\text{ s}$	V_{ISO}	4000	V_{RMS}
Storage temperature		T_{stg}	- 55 to + 150	$^{\circ}\text{C}$
Operating temperature		T_{amb}	- 40 to + 100	$^{\circ}\text{C}$
Lead solder temperature	for 10 s		260	$^{\circ}\text{C}$
Solder reflow temperature ⁽¹⁾	for 1 min	T_{sld}	260	$^{\circ}\text{C}$

Notes

- Stresses in excess of the absolute maximum ratings can cause permanent damage to the device. Functional operation of the device is not implied at these or any other conditions in excess of those given in the operational sections of this document. Exposure to absolute maximum ratings for extended periods of the time can adversely affect reliability.
- ⁽¹⁾ Refer to reflow profile for soldering conditions for surface mounted devices.

RECOMMENDED OPERATING CONDITIONS					
PARAMETER	TEST CONDITION	SYMBOL	MIN.	MAX.	UNIT
Operating temperature		T_{amb}	- 40	100	$^{\circ}\text{C}$
Supply voltage		V_{CC}	4.5	5.5	V
Input current low level		I_{FL}	0	250	μA
Input current high level		I_{FH}	5	15	mA
Output pull up resistor		R_L	330	4K	Ω
Fanout	$R_L = 1\text{ k}\Omega$	N		5	-

THERMAL CHARACTERISTICS					
PARAMETER	TEST CONDITION	SYMBOL	VALUE	UNIT	
LED power dissipation	at 25 °C	P_{diss}	100	mW	
Output power dissipation	at 25 °C	P_{diss}	500	mW	
Maximum LED junction temperature		T_{jmax}	125	°C	
Maximum output die junction temperature		T_{jmax}	125	°C	
Thermal resistance, junction emitter to emitter		θ_{EE}	412	°C/W	
Thermal resistance, junction detector to emitter		θ_{DE}	133	°C/W	
Thermal resistance, junction emitter to board		θ_{EB}	120	°C/W	
Thermal resistance, junction detector to board		θ_{DB}	77	°C/W	
Thermal resistance, junction emitter to case		θ_{EC}	110	°C/W	

Note

- The thermal model is represented in the thermal network below. Each resistance value given in this model can be used to calculate the temperatures at each node for a given operating condition. The thermal resistance from board to ambient will be dependent on the type of PCB, layout and thickness of copper traces. For a detailed explanation of the thermal model, please reference Vishay's Thermal Characteristics of Optocouplers application note.

ELECTRICAL CHARACTERISTICS ($T_{amb} = 25\text{ °C}$, and $V_{CC} = 5.5\text{ V}$, unless otherwise specified)						
PARAMETER	TEST CONDITION	SYMBOL	MIN.	TYP.	MAX.	UNIT
INPUT						
Input forward voltage	$I_F = 10\text{ mA}$	V_F	1.1	1.4	1.7	V
Reverse current	$V_R = 5\text{ V}$	I_R	-	0.01	10	μA
Input capacitance	$f = 1\text{ MHz}$, $V_F = 0\text{ V}$	C_I	-	55	-	pF
OUTPUT						
High level supply current (single channel)	$V_E = 0.5\text{ V}$, $I_F = 0\text{ mA}$	I_{CCH}	-	4.1	7	mA
	$V_E = V_{CC}$, $I_F = 0\text{ mA}$	I_{CCH}	-	3.3	6	mA
High level supply current (dual channel)	$I_F = 0\text{ mA}$	I_{CCH}	-	6.5	12	mA
Low level supply current (single channel)	$V_E = 0.5\text{ V}$, $I_F = 10\text{ mA}$	I_{CCL}	-	4	7	mA
	$V_E = V_{CC}$, $I_F = 10\text{ mA}$	I_{CCL}	-	3.3	6	mA
Low level supply current (dual channel)	$I_F = 10\text{ mA}$	I_{CCL}	-	6.5	12	mA
High level output current	$V_E = 2\text{ V}$, $V_O = 5.5\text{ V}$, $I_F = 250\text{ }\mu\text{A}$	I_{OH}	-	0.002	1	μA
Low level output voltage	$V_E = 2\text{ V}$, $I_F = 5\text{ mA}$, $I_{OL}(\text{sinking}) = 13\text{ mA}$	V_{OL}	-	0.2	0.6	V
Input threshold current	$V_E = 2\text{ V}$, $V_O = 5.5\text{ V}$, $I_{OL}(\text{sinking}) = 13\text{ mA}$	I_{TH}	-	2.4	5	mA

Note

- Minimum and maximum values are testing requirements. Typical values are characteristics of the device and are the result of engineering evaluation. Typical values are for information only and are not part of the testing requirements.

SWITCHING CHARACTERISTICS

PARAMETER	TEST CONDITION	SYMBOL	MIN.	TYP.	MAX.	UNIT
Propagation delay time to high output level	$R_L = 350 \Omega, C_L = 15 \text{ pF}$	t_{PLH}	20	48	100	ns
Propagation delay time to low output level	$R_L = 350 \Omega, C_L = 15 \text{ pF}$	t_{PHL}	25	50	100	ns
Pulse width distortion	$R_L = 350 \Omega, C_L = 15 \text{ pF}$	$ t_{PHL} - t_{PLH} $	-	2.9	35	ns
Propagation delay skew	$R_L = 350 \Omega, C_L = 15 \text{ pF}$	t_{PSK}	-	8	40	ns
Output rise time (10 to 90 %)	$R_L = 350 \Omega, C_L = 15 \text{ pF}$	t_r	-	23	-	ns
Output fall time (90 to 10 %)	$R_L = 350 \Omega, C_L = 15 \text{ pF}$	t_f	-	7	-	ns

Note

- Over recommended temperature ($T_A = -40 \text{ }^\circ\text{C}$ to $+100 \text{ }^\circ\text{C}$), $V_{CC} = 5 \text{ V}$, $I_F = 7.5 \text{ mA}$ unless otherwise specified. All typicals at $T_{amb} = 25 \text{ }^\circ\text{C}$, $V_{CC} = 5 \text{ V}$.

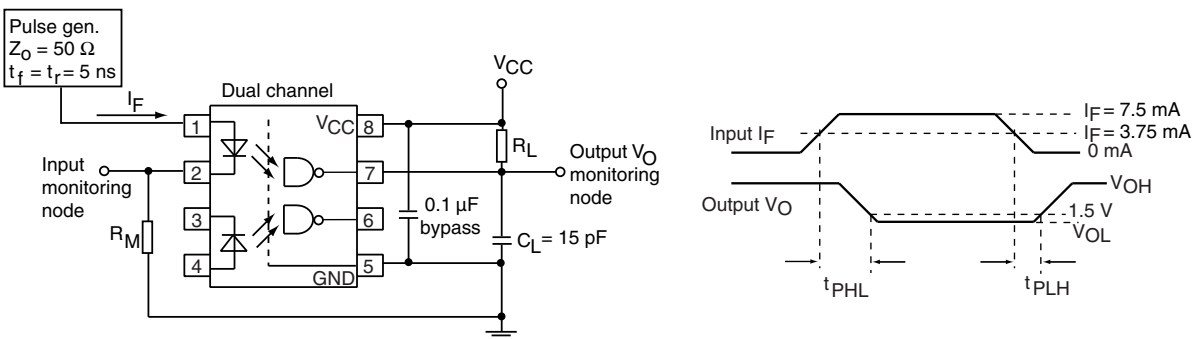
 Fig. 1 - Dual Channel Test Circuit for t_{PLH} , t_{PHL} , t_r and t_f
COMMON MODE TRANSIENT IMMUNITY

PARAMETER	TEST CONDITION	SYMBOL	MIN.	TYP.	MAX.	UNIT
Common mode transient immunity (high)	$ V_{CM} = 10 \text{ V}, V_{CC} = 5 \text{ V}, I_F = 0 \text{ mA}, V_{O(min.)} = 2 \text{ V}, R_L = 350 \Omega, T_{amb} = 25 \text{ }^\circ\text{C}$ (1)	$ CM_H $	100	-	-	V/ μs
	$ V_{CM} = 50 \text{ V}, V_{CC} = 5 \text{ V}, I_F = 0 \text{ mA}, V_{O(min.)} = 2 \text{ V}, R_L = 350 \Omega, T_{amb} = 25 \text{ }^\circ\text{C}$ (2)	$ CM_H $	5000	10 000	-	V/ μs
	$ V_{CM} = 1 \text{ kV}, V_{CC} = 5 \text{ V}, I_F = 0 \text{ mA}, V_{O(min.)} = 2 \text{ V}, R_L = 350 \Omega, T_{amb} = 25 \text{ }^\circ\text{C}$ (3)	$ CM_H $	15 000	25 000	-	V/ μs
Common mode transient immunity (low)	$ V_{CM} = 10 \text{ V}, V_{CC} = 5 \text{ V}, I_F = 7.5 \text{ mA}, V_{O(max.)} = 0.8 \text{ V}, R_L = 350 \Omega, T_{amb} = 25 \text{ }^\circ\text{C}$ (1)	$ CM_L $	100	-	-	V/ μs
	$ V_{CM} = 50 \text{ V}, V_{CC} = 5 \text{ V}, I_F = 7.5 \text{ mA}, V_{O(max.)} = 0.8 \text{ V}, R_L = 350 \Omega, T_{amb} = 25 \text{ }^\circ\text{C}$ (2)	$ CM_L $	5000	10 000	-	V/ μs
	$ V_{CM} = 1 \text{ kV}, V_{CC} = 5 \text{ V}, I_F = 7.5 \text{ mA}, V_{O(max.)} = 0.8 \text{ V}, R_L = 350 \Omega, T_{amb} = 25 \text{ }^\circ\text{C}$ (3)	$ CM_L $	15 000	25 000	-	V/ μs

Notes

- For SFH6755T
- For SFH6756T
- For SFH6757T

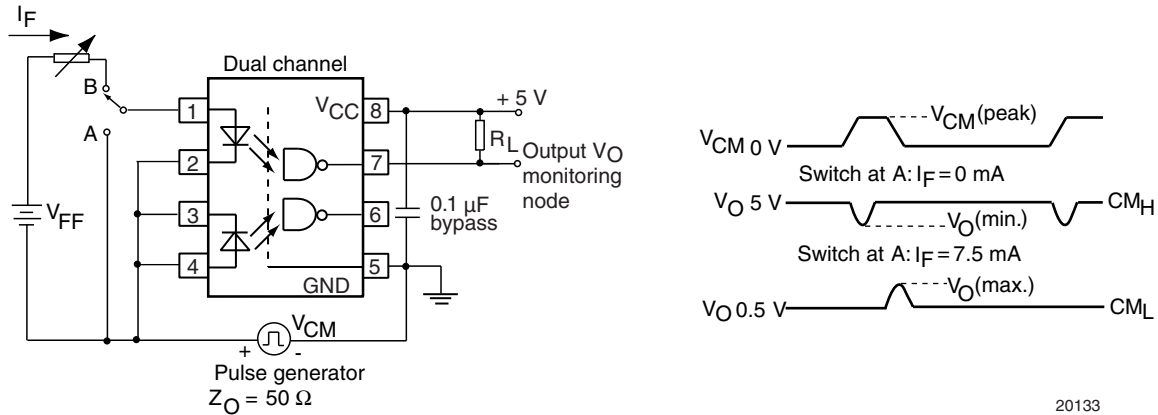

20133

Fig. 2 - Dual Channel Test Circuit for Common Mode Transient Immunity

SAFETY AND INSULATION RATINGS						
PARAMETER	TEST CONDITION	SYMBOL	MIN.	TYP.	MAX.	UNIT
Climatic classification	According to IEC 68 part 1			55 / 100 / 21		
Comparative tracking index		CTI	175		399	
Peak transient overvoltage		V_{IOTM}	6000			V
Peak insulation voltage		V_{IORM}	560			V
Safety rating - power output		P_{SO}			350	mW
Safety rating - input current		I_{SI}			150	mA
Safety rating - temperature		T_{SI}			165	$^{\circ}C$
Creepage distance			5			mm
Clearance distance			4			mm
Insulation thickness			0.2			mm

Note

- As per IEC 60747-5-5, §7.4.3.8.1, this optocoupler is suitable for "safe electrical insulation" only within the safety ratings. Compliance with the safety ratings shall be ensured by means of protective circuits.

TYPICAL CHARACTERISTICS ($T_{amb} = 25\text{ }^{\circ}\text{C}$, unless otherwise specified)

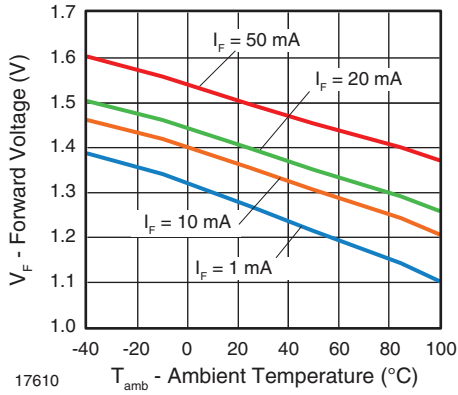

Fig. 3 - Forward Voltage vs. Ambient Temperature

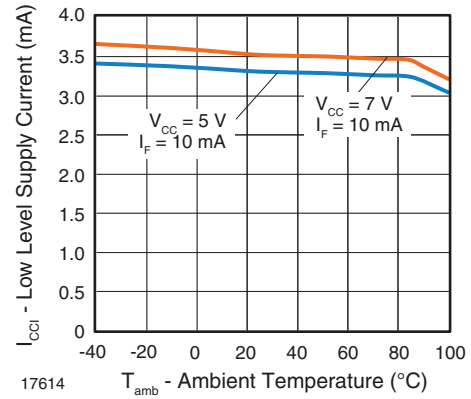

Fig. 6 - Low Level Supply Current vs. Ambient Temperature

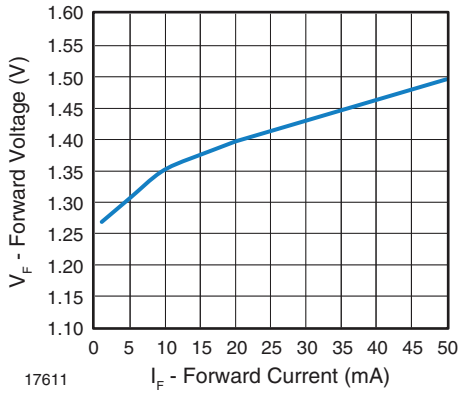

Fig. 4 - Forward Voltage vs. Forward Current

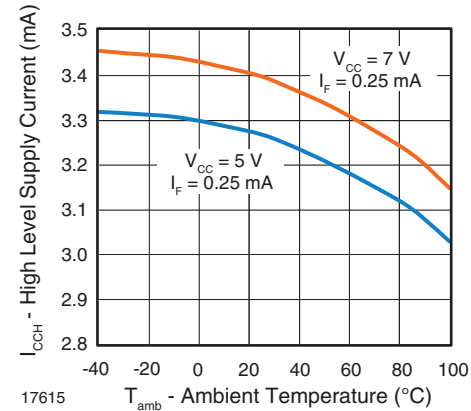

Fig. 7 - High Level Supply Current vs. Ambient Temperature

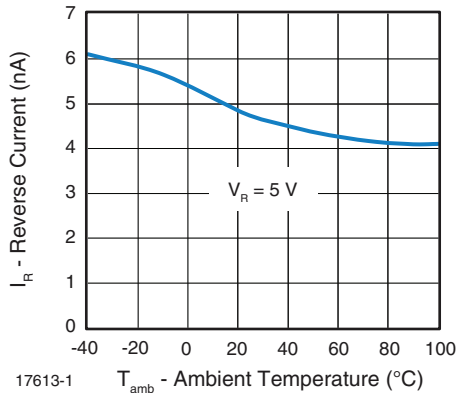

Fig. 5 - Reverse Current vs. Ambient Temperature

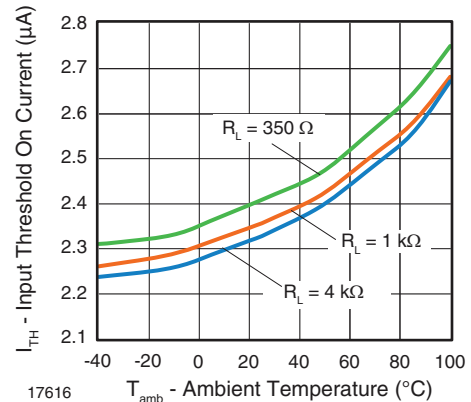

Fig. 8 - Input Threshold on Current vs. Ambient Temperature

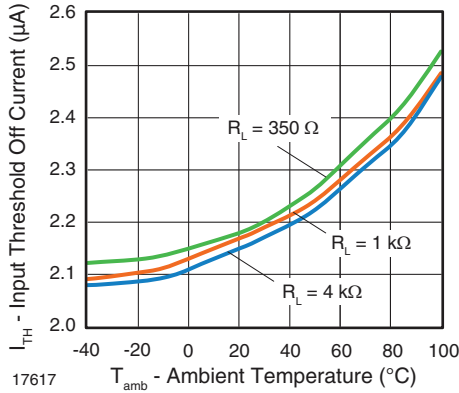

Fig. 9 - Input Threshold off Current vs. Ambient Temperature

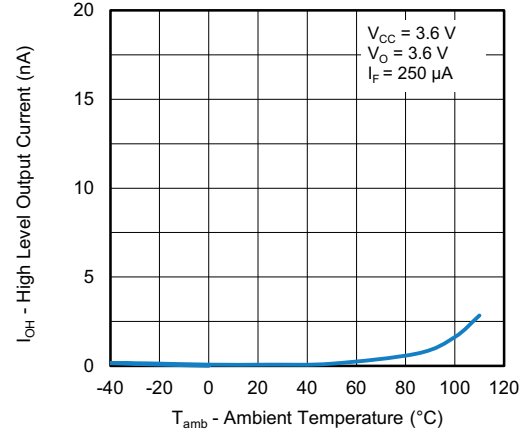

Fig. 12 - High Level Output Current vs. Ambient Temperature

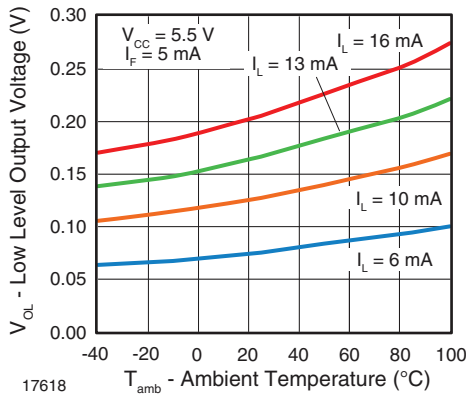

Fig. 10 - Low Level Output Voltage vs. Ambient Temperature

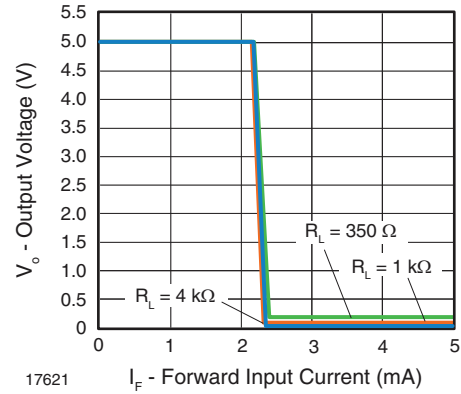

Fig. 13 - Output Voltage vs. Forward Input Current

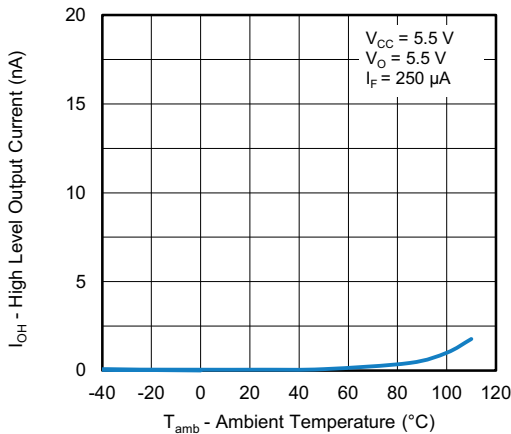

Fig. 11 - Low Level Output Current vs. Ambient Temperature

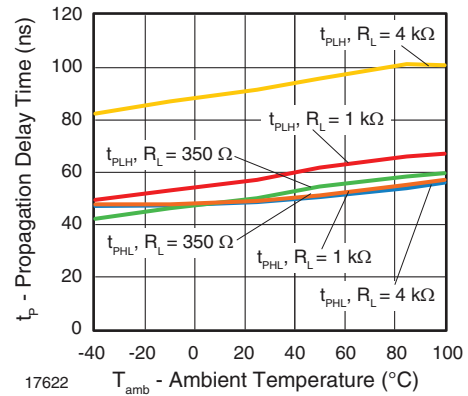

Fig. 14 - Propagation Delay vs. Ambient Temperature

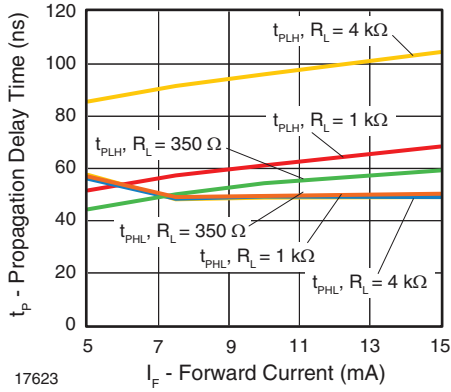

Fig. 15 - Propagation Delay vs. Forward Current

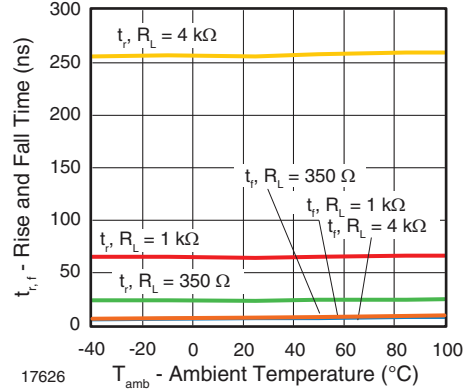

Fig. 18 - Rise and Fall Time vs. Ambient Temperature

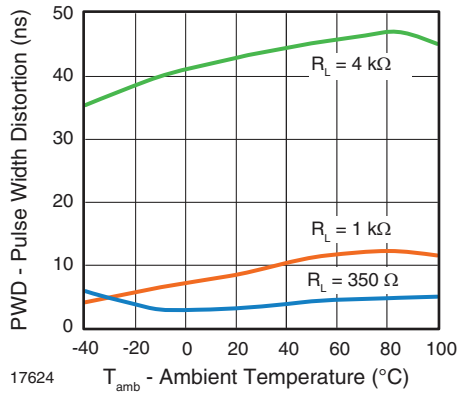

Fig. 16 - Pulse Width Distortion vs. Ambient Temperature

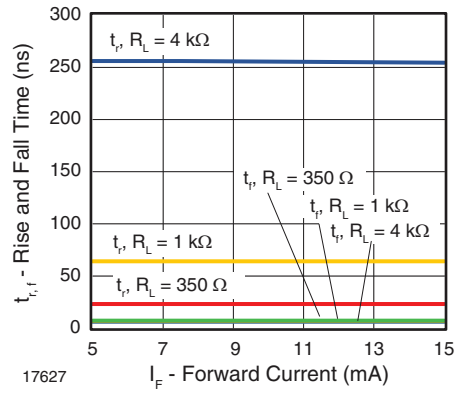

Fig. 19 - Rise and Fall Time vs. Forward Current

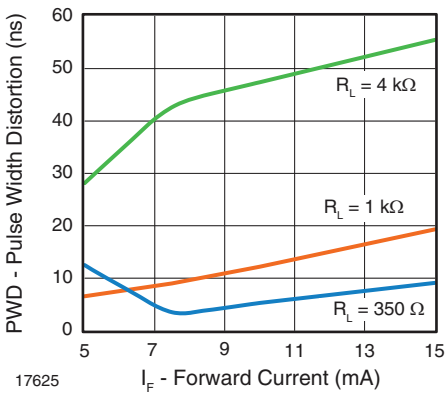
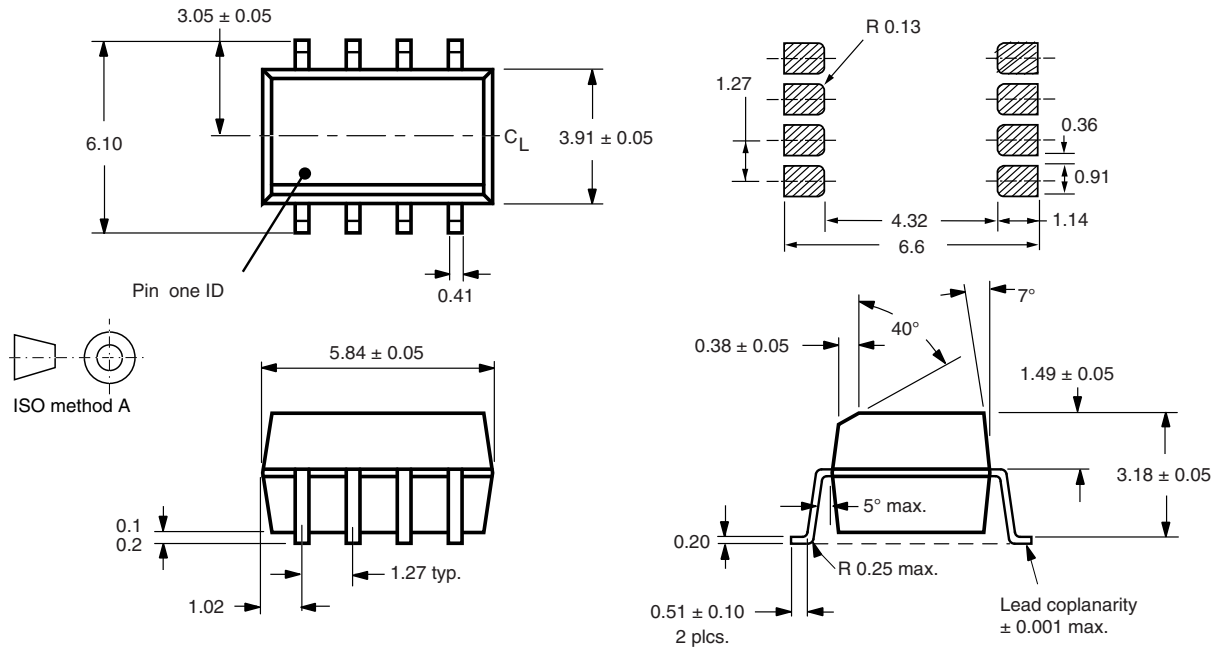

Fig. 17 - Pulse Width Distortion vs. Forward Current



PACKAGE DIMENSIONS in millimeters

Dual Channel SOIC-8



1178020

PACKAGE MARKING (example)

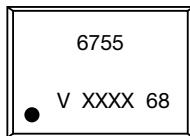

Example for SFH6755T

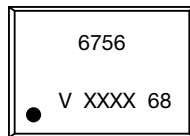

Example for SFH6756T

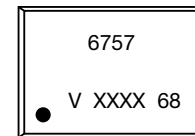

Example for SFH6757T

Notes

- XXXX = LMC (lot marking code)
- "X1" is only marked on option 1 parts
- Tape and reel suffix (T) is not part of the package marking

ESD CAUTION

This is an ESD (electro static discharge) sensitive device. Electrostatic charges accumulate on the human body and test equipment and can discharge without detection. Therefore, proper ESD precautions are recommended to avoid performance degradation or loss of functionality. ESD withstand voltage of this device is up to 1500 V acc. to JESD22-A114-B.



Disclaimer

ALL PRODUCT, PRODUCT SPECIFICATIONS AND DATA ARE SUBJECT TO CHANGE WITHOUT NOTICE TO IMPROVE RELIABILITY, FUNCTION OR DESIGN OR OTHERWISE.

Vishay Intertechnology, Inc., its affiliates, agents, and employees, and all persons acting on its or their behalf (collectively, "Vishay"), disclaim any and all liability for any errors, inaccuracies or incompleteness contained in any datasheet or in any other disclosure relating to any product.

Vishay makes no warranty, representation or guarantee regarding the suitability of the products for any particular purpose or the continuing production of any product. To the maximum extent permitted by applicable law, Vishay disclaims (i) any and all liability arising out of the application or use of any product, (ii) any and all liability, including without limitation special, consequential or incidental damages, and (iii) any and all implied warranties, including warranties of fitness for particular purpose, non-infringement and merchantability.

Statements regarding the suitability of products for certain types of applications are based on Vishay's knowledge of typical requirements that are often placed on Vishay products in generic applications. Such statements are not binding statements about the suitability of products for a particular application. It is the customer's responsibility to validate that a particular product with the properties described in the product specification is suitable for use in a particular application. Parameters provided in datasheets and / or specifications may vary in different applications and performance may vary over time. All operating parameters, including typical parameters, must be validated for each customer application by the customer's technical experts. Product specifications do not expand or otherwise modify Vishay's terms and conditions of purchase, including but not limited to the warranty expressed therein.

Hyperlinks included in this datasheet may direct users to third-party websites. These links are provided as a convenience and for informational purposes only. Inclusion of these hyperlinks does not constitute an endorsement or an approval by Vishay of any of the products, services or opinions of the corporation, organization or individual associated with the third-party website. Vishay disclaims any and all liability and bears no responsibility for the accuracy, legality or content of the third-party website or for that of subsequent links.

Except as expressly indicated in writing, Vishay products are not designed for use in medical, life-saving, or life-sustaining applications or for any other application in which the failure of the Vishay product could result in personal injury or death. Customers using or selling Vishay products not expressly indicated for use in such applications do so at their own risk. Please contact authorized Vishay personnel to obtain written terms and conditions regarding products designed for such applications.

No license, express or implied, by estoppel or otherwise, to any intellectual property rights is granted by this document or by any conduct of Vishay. Product names and markings noted herein may be trademarks of their respective owners.