

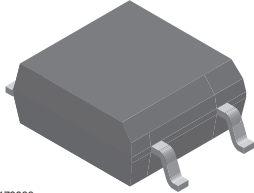

## Optocoupler Phototransistor Output, SOP-4, 100 mil Pitch, Mini-Flat Package

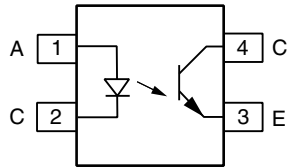

i179066



### DESCRIPTION

The SFH690ABT, SFH690AT, SFH690BT, SFH690CT, SFH690DT family has a GaAs infrared emitting diode emitter, which is optically coupled to a silicon planar phototransistor detector, and is incorporated in a 4 pin 100 mil lead pitch miniflat package. It features a high current transfer ratio, low coupling capacitance, and high isolation voltage.

The coupling devices are designed for signal transmission between two electrically separated circuits. The SFH690 series is available only on tape and reel. There are 2000 parts per reel. Marking for SFH690AT is 690A; SFH690BT is 690B; SFH690CT is 690C; SFH690DT is 690D; SFH690ABT will be marked as 690A or 690B.

### FEATURES

- SOP (small outline package)
- Isolation test voltage, 3750 V<sub>RMS</sub> (1 s)
- High collector emitter breakdown voltage, V<sub>CEO</sub> = 70 V
- Low saturation voltage
- Fast switching times
- Temperature stable
- Low coupling capacitance
- End-stackable, 0.100" (2.54 mm) spacing
- Material categorization: for definitions of compliance please see [www.vishay.com/doc?99912](http://www.vishay.com/doc?99912)

### APPLICATIONS

- High density mounting or space sensitive PCBs
- PLCs
- Telecommunication

### AGENCY APPROVALS

- UL1577, file no. E52744 system code U
- cUL tested to CSA 22.2 bulletin 5A
- BSI EN 60950; EN 60065
- DIN EN 60747-5-5 (VDE 0885-5) available with option 1
- CQC GB4943.1-2011 and GB8898-2011 (suitable for installation altitude below 2000 m)

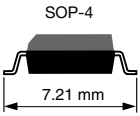
ORDERING INFORMATION					
<div style="display: flex; justify-content: space-around; align-items: center;"> <div style="text-align: center;"> <div style="border: 1px solid black; padding: 2px;">S</div> <div style="border: 1px solid black; padding: 2px;">F</div> <div style="border: 1px solid black; padding: 2px;">H</div> <div style="border: 1px solid black; padding: 2px;">6</div> <div style="border: 1px solid black; padding: 2px;">9</div> <div style="border: 1px solid black; padding: 2px;">0</div> <div style="border: 1px solid black; padding: 2px;">x</div> <div style="border: 1px solid black; padding: 2px;">x</div> <div style="border: 1px solid black; padding: 2px;">-</div> <div style="border: 1px solid black; padding: 2px;">X</div> <div style="border: 1px solid black; padding: 2px;">0</div> <div style="border: 1px solid black; padding: 2px;">0</div> <div style="border: 1px solid black; padding: 2px;">1</div> <div style="border: 1px solid black; padding: 2px;">T</div> </div> <div style="margin-left: 20px;"> <p style="text-align: center;">PART NUMBER</p> <p style="text-align: center;">CTR BIN</p> <p style="text-align: center;">PACKAGE OPTION</p> <p style="text-align: center;">TAPE AND REEL</p> </div> <div style="margin-left: 20px;">  </div> </div>					
AGENCY CERTIFIED/PACKAGE	CTR (%)				
UL, cUL, BSI	50 to 300	50 to 150	100 to 300	100 to 200	200 to 400
SOP-4, 100 mil pitch	SFH690ABT	SFH690AT3 <sup>(1)</sup> , SFH690AT <sup>(2)</sup>	SFH690BT3 <sup>(1)</sup> , SFH690BT <sup>(2)</sup>	SFH690CT	SFH690DT
VDE, UL, cUL, BSI	50 to 300	50 to 150	100 to 300	100 to 200	200 to 400
SOP-4, 100 mil pitch	-	-	SFH690B-X001T	SFH690C-X001T	SFH690D-X001T

### Notes

- (1) Product is rotated 180° in tape and reel cavity
- (2) Also available in tubes, do not put "T" to the end



<b>ABSOLUTE MAXIMUM RATINGS</b> ( $T_{amb} = 25\text{ }^{\circ}\text{C}$ , unless otherwise specified)				
PARAMETER	TEST CONDITION	SYMBOL	VALUE	UNIT
<b>INPUT</b>				
Reverse voltage		$V_R$	6	V
DC forward current		$I_F$	50	mA
Surge forward current	$t_p \leq 10\text{ }\mu\text{s}$	$I_{FSM}$	2.5	A
Power dissipation		$P_{diss}$	80	mW
<b>OUTPUT</b>				
Collector emitter voltage		$V_{CEO}$	70	V
Emitter collector voltage		$V_{ECO}$	7	V
Collector current		$I_C$	50	mA
	$t_p \leq 1\text{ ms}$	$I_C$	100	mA
Power dissipation		$P_{diss}$	150	mW
<b>COUPLER</b>				
Isolation resistance	$V_{IO} = 500\text{ V}, T_{amb} = 25\text{ }^{\circ}\text{C}$	$R_{IO}$	$\geq 10^{12}$	$\Omega$
	$V_{IO} = 500\text{ V}, T_{amb} = 100\text{ }^{\circ}\text{C}$	$R_{IO}$	$\geq 10^{11}$	$\Omega$
Storage temperature range		$T_{stg}$	- 55 to + 150	$^{\circ}\text{C}$
Ambient temperature range		$T_{amb}$	- 55 to + 100	$^{\circ}\text{C}$
Soldering temperature <sup>(1)</sup>	max. 10 s dip soldering distance to seating plane $\geq 1.5\text{ mm}$	$T_{sld}$	260	$^{\circ}\text{C}$

**Notes**

- Stresses in excess of the absolute maximum ratings can cause permanent damage to the device. Functional operation of the device is not implied at these or any other conditions in excess of those given in the operational sections of this document. Exposure to absolute maximum ratings for extended periods of the time can adversely affect reliability.
- <sup>(3)</sup> Refer to reflow profile for soldering conditions for surface mounted devices.

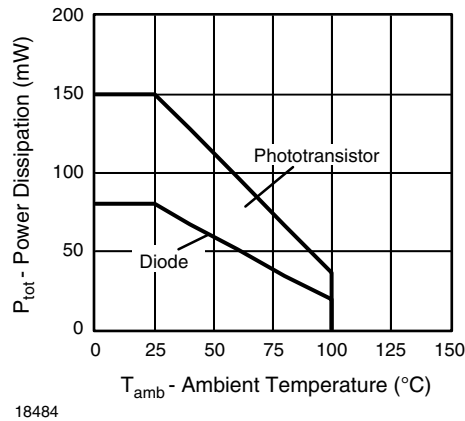

Fig. 1 - Permissible Power Dissipation vs. Ambient Temperature

<b>ELECTRICAL CHARACTERISTICS</b> ( $T_{amb} = 25\text{ }^{\circ}\text{C}$ , unless otherwise specified)						
PARAMETER	TEST CONDITION	SYMBOL	MIN.	TYP.	MAX.	UNIT
<b>INPUT</b>						
Forward voltage	$I_F = 5\text{ mA}$	$V_F$	-	1.15	1.4	V
Reverse current	$V_R = 6\text{ V}$	$I_R$	-	0.01	10	$\mu\text{A}$
Capacitance	$V_R = 0\text{ V}$ , $f = 1\text{ MHz}$	$C_O$	-	14	-	pF
Thermal resistance		$R_{thJA}$	-	750	-	K/W
<b>OUTPUT</b>						
Collector emitter leakage current	$V_{CE} = 20\text{ V}$	$I_{CEO}$	-	-	100	nA
Collector emitter capacitance	$V_{CE} = 5\text{ V}$ , $f = 1\text{ MHz}$	$C_{CE}$	-	2.8	-	pF
Thermal resistance		$R_{thJA}$	-	500	-	K/W
<b>COUPLER</b>						
Collector emitter saturation voltage	$I_F = 10\text{ mA}$ , $I_C = 2\text{ mA}$	$V_{CEsat}$	-	0.1	0.3	V
Coupling capacitance	$f = 1\text{ MHz}$	$C_C$	-	0.3	-	pF

**Note**

- Minimum and maximum values are testing requirements. Typical values are characteristics of the device and are the result of engineering evaluation. Typical values are for information only and are not part of the testing requirements.

<b>CURRENT TRANSFER RATIO</b> ( $T_{amb} = 25\text{ }^{\circ}\text{C}$ , unless otherwise specified)							
PARAMETER	TEST CONDITION	PART	SYMBOL	MIN.	TYP.	MAX.	UNIT
$I_C/I_F$	$I_F = 5\text{ mA}$ , $V_{CE} = 5\text{ V}$	SFH690ABT	CTR	50	-	300	%
		SFH690AT	CTR	50	-	150	%
		SFH690BT	CTR	100	-	300	%
		SFH690CT	CTR	100	-	200	%
		SFH690DT	CTR	200	-	400	%

<b>SWITCHING CHARACTERISTICS</b> ( $T_{amb} = 25\text{ }^{\circ}\text{C}$ , unless otherwise specified)						
PARAMETER	TEST CONDITION	SYMBOL	MIN.	TYP.	MAX.	UNIT
Rise time	$I_C = 2\text{ mA}$ , $V_{CC} = 5\text{ V}$ , $R_L = 100\text{ }\Omega$	$t_r$	-	3	-	$\mu\text{s}$
Fall time	$I_C = 2\text{ mA}$ , $V_{CC} = 5\text{ V}$ , $R_L = 100\text{ }\Omega$	$t_f$	-	4	-	$\mu\text{s}$
Turn-on time	$I_C = 2\text{ mA}$ , $V_{CC} = 5\text{ V}$ , $R_L = 100\text{ }\Omega$	$t_{on}$	-	5	-	$\mu\text{s}$
Turn-off time	$I_C = 2\text{ mA}$ , $V_{CC} = 5\text{ V}$ , $R_L = 100\text{ }\Omega$	$t_{off}$	-	3	-	$\mu\text{s}$

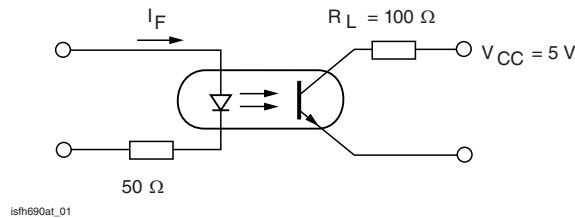

Fig. 2 - Switching Operation (without saturation)



SAFETY AND INSULATION RATINGS				
PARAMETER	CONDITION	SYMBOL	VALUE	UNIT
Climatic classification	According to IEC 68 part 1		55 / 100 / 21	
Partial discharge test voltage - lot test (sample test)	$t_{Tr} = 60$ s, $t_{test} = 10$ s, (see Fig. 2)	$V_{IOTM}$	6000	$V_{peak}$
Isolation test voltage (RMS)		$V_{ISO}$	3750	$V_{RMS}$
Isolation resistance	$V_{IO} = 500$ V, $T_{amb} = 25$ °C	$R_{IO}$	$\geq 10^{12}$	$\Omega$
	$V_{IO} = 500$ V, $T_{amb} = 100$ °C	$R_{IO}$	$\geq 10^{11}$	$\Omega$
Forward current		$I_{si}$	150	mA
Power dissipation		$P_{so}$	350	mW
Safety temperature		$T_{si}$	175	°C
Comparative tracking index		CTI	175	
Clearance distance			5.0	mm
Creepage distance			5.0	mm
Insulation distance (internal)			0.4	mm

**Note**

- According to DIN EN 60747-5-2 (VDE 0884) (see fig. 2). This optocoupler is suitable for safe electrical isolation only within the safety ratings. Compliance with the safety ratings shall be ensured by means of suitable protective circuits.

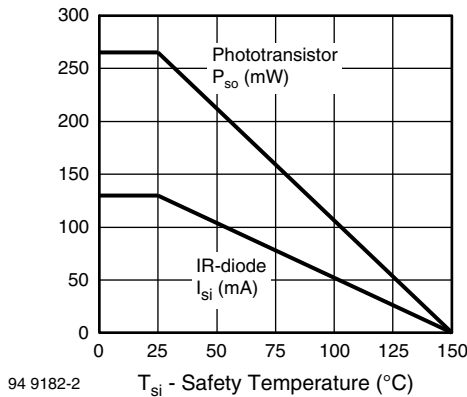

Fig. 3 - Derating Diagram

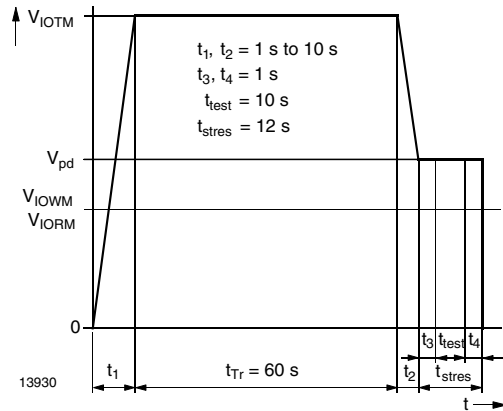

Fig. 4 - Test Pulse Diagram for Sample Test according to DIN EN 60747-5-2 (VDE 0884); IEC60747-5-5



TYPICAL CHARACTERISTICS (T<sub>amb</sub> = 25 °C, unless otherwise specified)

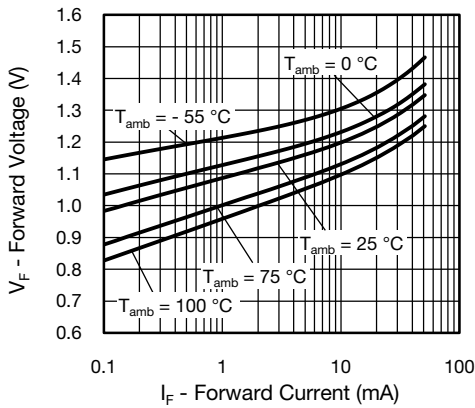

Fig. 5 - Forward Voltage vs. Forward Current

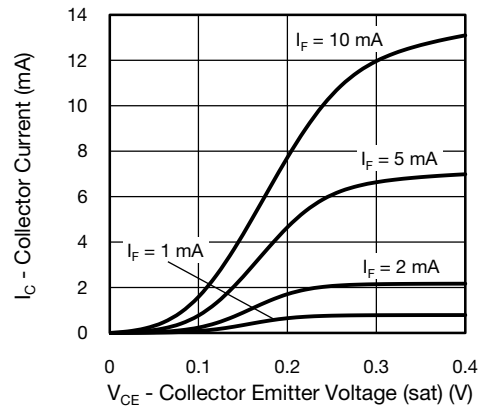

Fig. 8 - Collector Current vs. Collector Emitter Voltage (saturated)

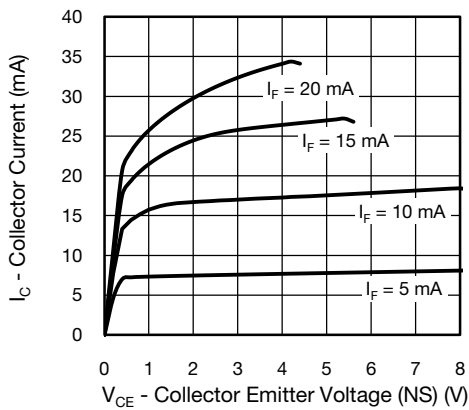

Fig. 6 - Collector Current vs. Collector Emitter Voltage (non-saturated)

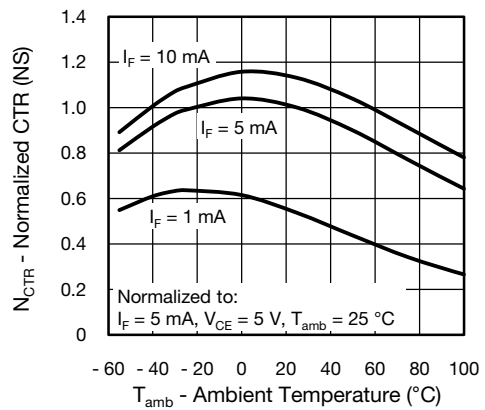

Fig. 9 - Normalized Current Transfer Ratio vs. Ambient Temperature

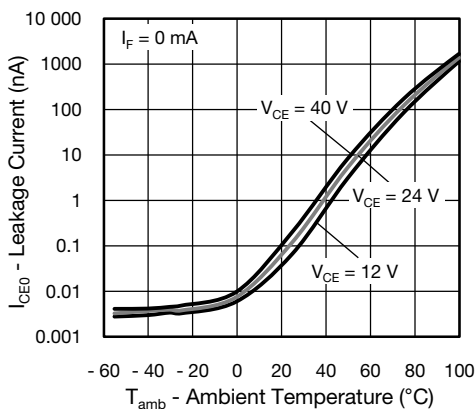

Fig. 7 - Leakage Current vs. Ambient Temperature

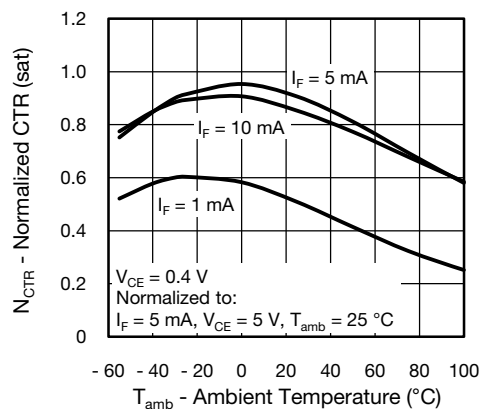

Fig. 10 - Normalized Current Transfer Ratio (saturated) vs. Ambient Temperature

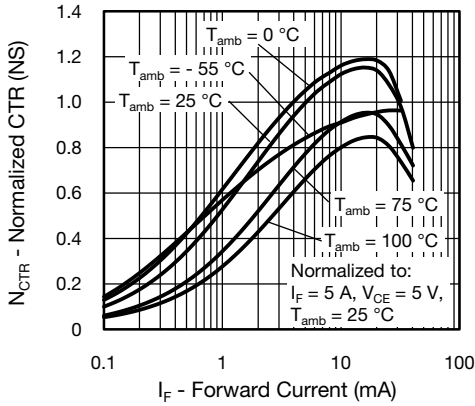

Fig. 11 - Normalized CTR (non-saturated) vs. Forward Current

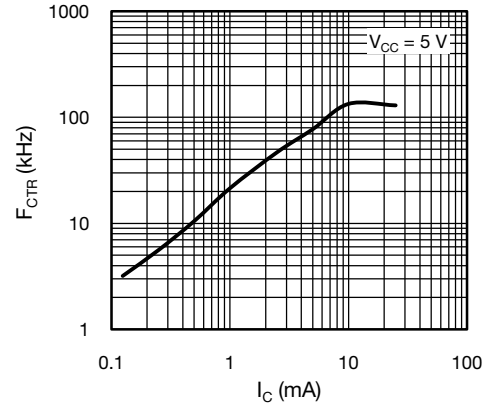

Fig. 14 -  $F_{CTR}$  vs. Collector Current

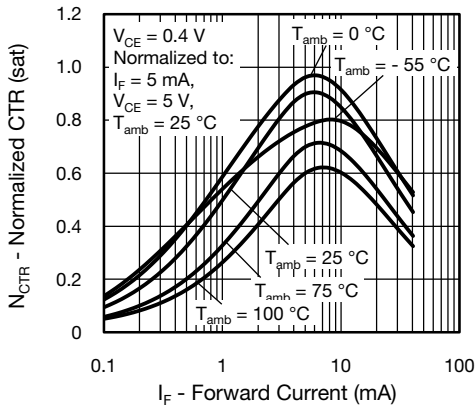

Fig. 12 - Normalized CTR (saturated) vs. Forward Current

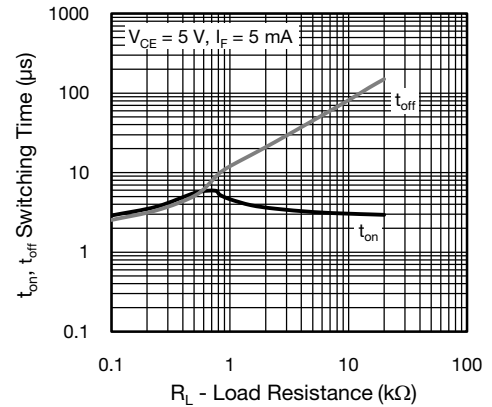

Fig. 15 - Switching Time vs. Load Resistance

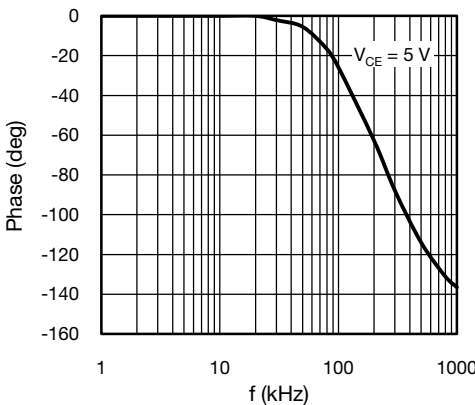
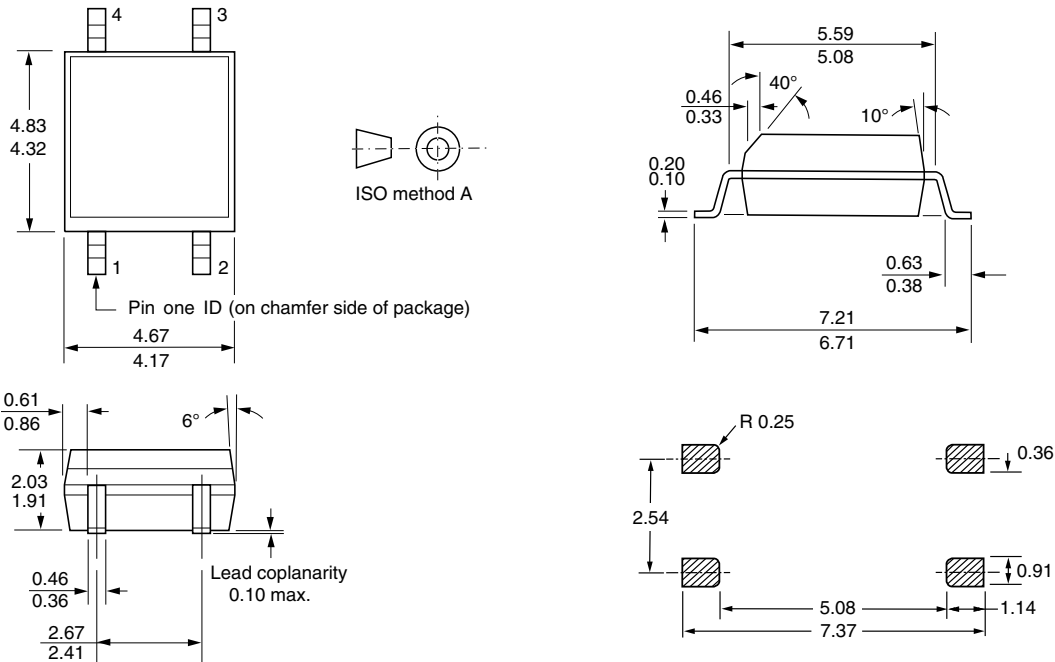

Fig. 13 -  $F_{CTR}$  vs. Phase Angle



**PACKAGE DIMENSIONS** (in millimeters)



i178037

**PACKAGE MARKING** (example of SFH690AT)

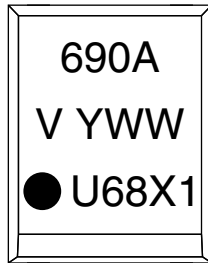

**Notes**

- Only option 1 is reflected in the package marking with the characters "X1"
- Tape and reel suffix (T) is not part of the package marking



## **Disclaimer**

ALL PRODUCT, PRODUCT SPECIFICATIONS AND DATA ARE SUBJECT TO CHANGE WITHOUT NOTICE TO IMPROVE RELIABILITY, FUNCTION OR DESIGN OR OTHERWISE.

Vishay Intertechnology, Inc., its affiliates, agents, and employees, and all persons acting on its or their behalf (collectively, "Vishay"), disclaim any and all liability for any errors, inaccuracies or incompleteness contained in any datasheet or in any other disclosure relating to any product.

Vishay makes no warranty, representation or guarantee regarding the suitability of the products for any particular purpose or the continuing production of any product. To the maximum extent permitted by applicable law, Vishay disclaims (i) any and all liability arising out of the application or use of any product, (ii) any and all liability, including without limitation special, consequential or incidental damages, and (iii) any and all implied warranties, including warranties of fitness for particular purpose, non-infringement and merchantability.

Statements regarding the suitability of products for certain types of applications are based on Vishay's knowledge of typical requirements that are often placed on Vishay products in generic applications. Such statements are not binding statements about the suitability of products for a particular application. It is the customer's responsibility to validate that a particular product with the properties described in the product specification is suitable for use in a particular application. Parameters provided in datasheets and / or specifications may vary in different applications and performance may vary over time. All operating parameters, including typical parameters, must be validated for each customer application by the customer's technical experts. Product specifications do not expand or otherwise modify Vishay's terms and conditions of purchase, including but not limited to the warranty expressed therein.

Except as expressly indicated in writing, Vishay products are not designed for use in medical, life-saving, or life-sustaining applications or for any other application in which the failure of the Vishay product could result in personal injury or death. Customers using or selling Vishay products not expressly indicated for use in such applications do so at their own risk. Please contact authorized Vishay personnel to obtain written terms and conditions regarding products designed for such applications.

No license, express or implied, by estoppel or otherwise, to any intellectual property rights is granted by this document or by any conduct of Vishay. Product names and markings noted herein may be trademarks of their respective owners.