

Load Switch with Level-Shift

| PRODUCT SUMMARY | | |
|-----------------|---------------------------|------------|
| V_{DS2} (V) | $R_{DS(on)}$ (Ω) | I_D (A) |
| 1.8 to 8 | 0.625 at $V_{IN} = 4.5$ V | ± 0.43 |
| | 0.890 at $V_{IN} = 2.5$ V | ± 0.36 |
| | 1.25 at $V_{IN} = 1.8$ V | ± 0.3 |

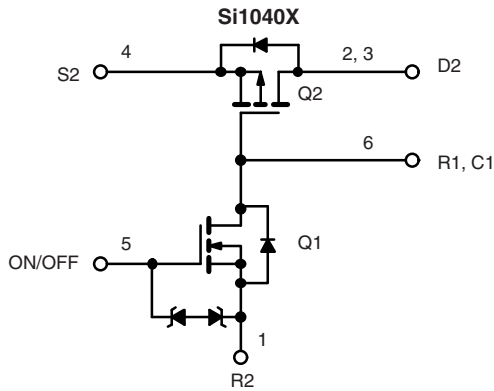

SC89-6
Top View

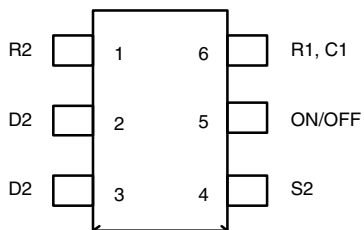

Ordering Information: Si1040X-T1-GE3 (Lead (Pb)-free and Halogen-free)

TYPICAL APPLICATION CIRCUIT

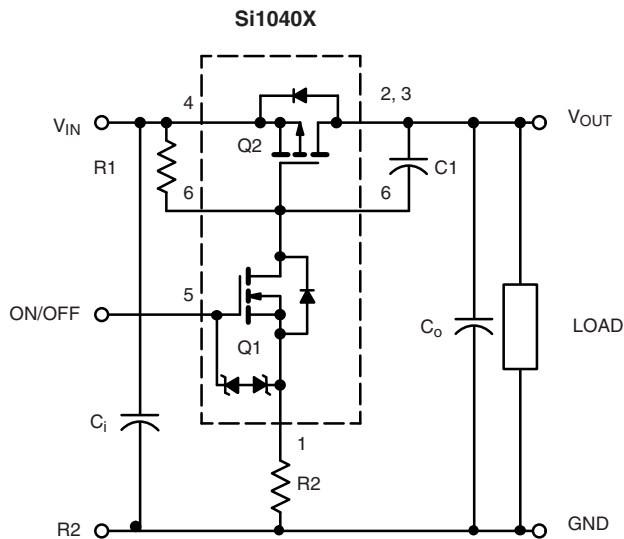

FEATURES

- Halogen-free According to IEC 61249-2-21 Definition
- TrenchFET[®] Power MOSFET
- 1.8 V to 8 V Input
- 1.5 V to 8 V Logic Level Control
- Smallest LITTLE FOOT[®] Package: 1.6 mm x 1.6 mm
- 2000 V ESD Protection On Input Switch, $V_{ON/OFF}$
- Adjustable Slew-Rate
- Compliant to RoHS Directive 2002/95/EC



RoHS
COMPLIANT
HALOGEN
FREE

DESCRIPTION

The Si1040X includes a p- and n-Channel MOSFET in a single SC89-6 package. The low on-resistance p-channel TrenchFET is tailored for use as a load switch. The n-channel, with an external resistor, can be used as a level-shift to drive the p-channel load-switch. The n-channel MOSFET has internal ESD protection and can be driven by logic signals as low as 1.5 V. The Si1040X operates on supply lines from 1.8 V to 8 V, and can drive loads up to 0.43 A.

Marking Code

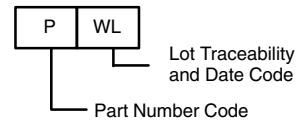

Switching Variation R2 at $V_{IN} = 2.5$ V, $R1 = 20$ k Ω

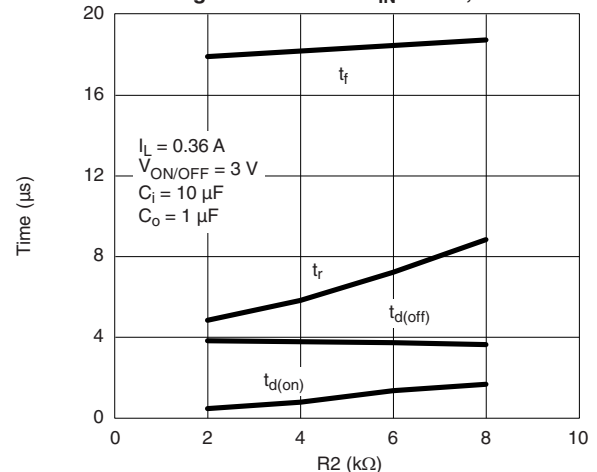

Note: For R2 switching variations with other $V_{IN}/R1$ combinations See Typical Characteristics

| COMPONENTS | | |
|------------|----------------------------|--|
| R1 | Pull-Up Resistor | Typical 10 k Ω to 1 m Ω ^a |
| R2 | Optional Slew-Rate Control | Typical 0 to 100 k Ω ^a |
| C1 | Optional Slew-Rate Control | Typical 1000 pF |

Notes:

a. Minimum R1 value should be at least 10 x R2 to ensure Q1 turn-on.

The Si1040X is ideally suited for high-side load switching in portable applications. The integrated N-Channel level-shift device saves space by reducing external components. The slew rate is set externally so that rise-times can be tailored to different load types.

| ABSOLUTE MAXIMUM RATINGS (T _A = 25 °C, unless otherwise noted) | | | |
|---|-----------------------------------|-------------|------|
| Parameter | Symbol | Limit | Unit |
| Input Voltage | V _{IN} | 8 | V |
| ON/OFF Voltage | V _{ON/OFF} | 8 | |
| Load Current | Continuous ^{a, b} | ± 0.43 | A |
| | Pulsed ^{b, c} | ± 1.0 | |
| Continuous Intrinsic Diode Conduction ^a | I _S | - 0.15 | |
| Maximum Power Dissipation ^a | P _D | 0.174 | W |
| Operating Junction and Storage Temperature Range | T _J , T _{stg} | - 55 to 150 | °C |
| ESD Rating, MIL-STD-883D Human Body Model (100 pF, 1500 Ω) | ESD | 2 | kV |

| THERMAL RESISTANCE RATINGS | | | | |
|---|-------------------|---------|---------|------|
| Parameter | Symbol | Typical | Maximum | Unit |
| Maximum Junction-to-Ambient (Continuous Current) ^a | R _{thJA} | 600 | 720 | °C/W |
| Maximum Junction-to-Foot (Q2) | R _{thJC} | 450 | 540 | |

Notes:

a. Surface mounted on 1" x 1" FR4 board.

| SPECIFICATIONS (T _J = 25 °C, unless otherwise noted) | | | | | | |
|---|---------------------|--|------|-------|-------|----------|
| Parameter | Symbol | Test Conditions | Min. | Typ. | Max. | Unit |
| OFF Characteristics | | | | | | |
| Reverse Leakage Current | I _{FL} | V _{IN} = 8 V, V _{ON/OFF} = 0 V | | | 1 | μ A |
| Diode Forward Voltage | V _{SD} | I _S = - 0.15 A | | 0.85 | 1.2 | V |
| ON Characteristics | | | | | | |
| Input Voltage Range | V _{IN} | | 1.8 | | 8 | V |
| On-Resistance (P-Channel) at 1 A | R _{DS(on)} | V _{ON/OFF} = 1.5 V, V _{IN} = 4.5 V, I _D = 0.43 A | | 0.500 | 0.625 | Ω |
| | | V _{ON/OFF} = 1.5 V, V _{IN} = 2.5 V, I _D = 0.36 A | | 0.710 | 0.890 | |
| | | V _{ON/OFF} = 1.5 V, V _{IN} = 1.8 V, I _D = 0.3 A | | 1.0 | 1.25 | |
| On-State (P-Channel) Drain Current | I _{D(on)} | V _{IN-OUT} \leq 0.2 V, V _{IN} = 5 V, V _{ON/OFF} = 1.5 V | 1 | | | A |
| | | V _{IN-OUT} \leq 0.3 V, V _{IN} = 3 V, V _{ON/OFF} = 1.5 V | 0.8 | | | |

Notes:

a. Surface mounted on FR4 board.

b. V_{IN} = 8 V, V_{ON/OFF} = 8 V, T_A = 25 °C.c. Pulse test; pulse width \leq 300 μ s, duty cycle \leq 2 %.

Stresses beyond those listed under "Absolute Maximum Ratings" may cause permanent damage to the device. These are stress ratings only, and functional operation of the device at these or any other conditions beyond those indicated in the operational sections of the specifications is not implied. Exposure to absolute maximum rating conditions for extended periods may affect device reliability.

TYPICAL CHARACTERISTICS (25 °C, unless otherwise noted)

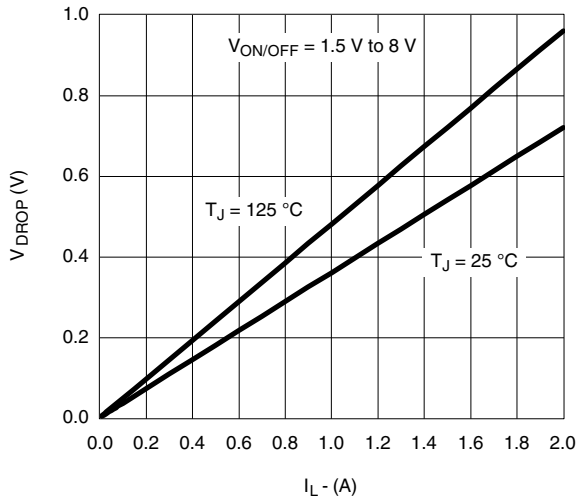

V_{DROP} vs. I_L at V_{IN} = 4.5 V

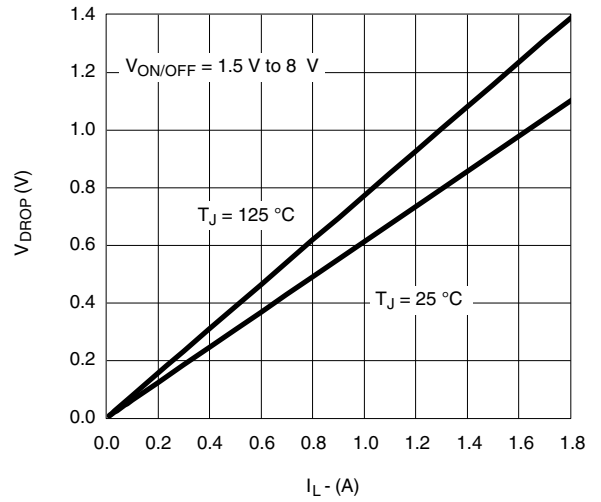

V_{DROP} vs. I_L at V_{IN} = 2.5 V

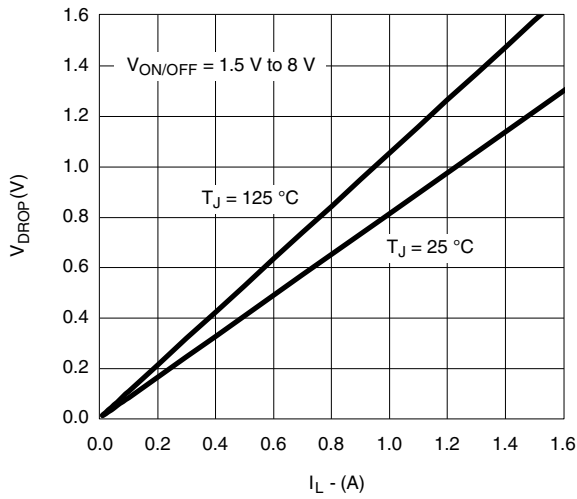

V_{DROP} vs. I_L at V_{IN} = 1.8 V

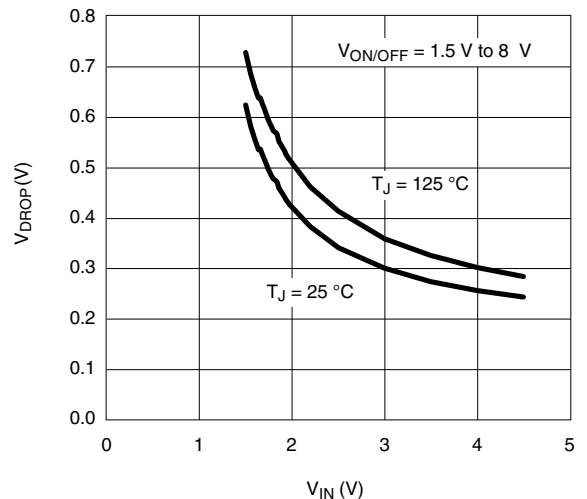

V_{DROP} vs. I_L at V_{IN} = 0.5 V

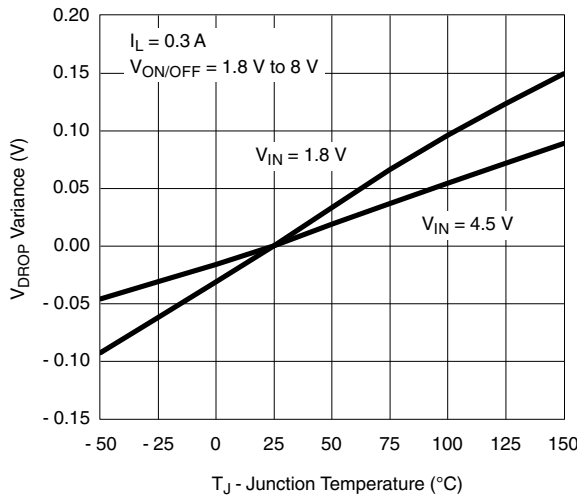

V_{DROP} Variance vs. Junction Temperature

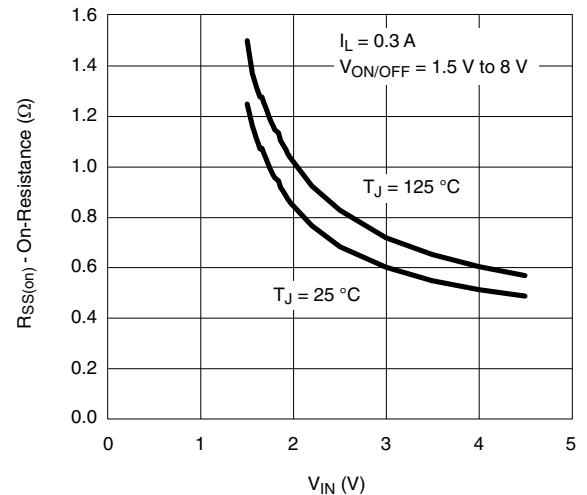

On-Resistance vs. Input Voltage

TYPICAL CHARACTERISTICS (25 °C, unless otherwise noted)

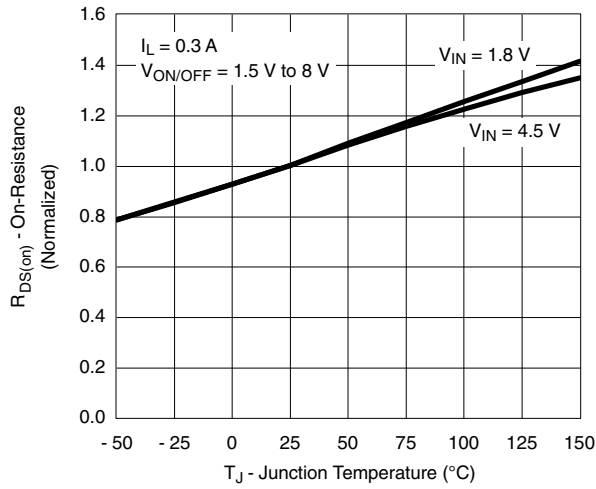

Normalized On-Resistance vs. Junction Temperature

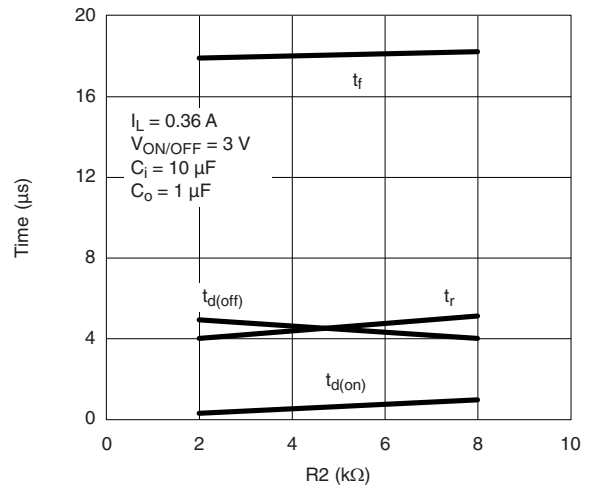

Switching Variation R2 at $V_{IN} = 4.5 \text{ V}$, $R1 = 20 \text{ kW}$

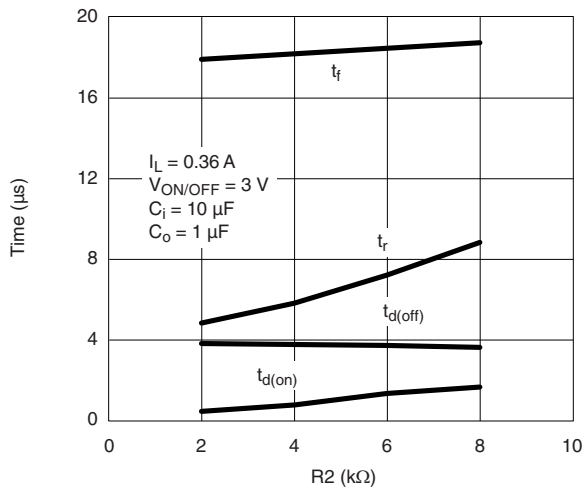

Switching Variation R2 at $V_{IN} = 2.5 \text{ V}$, $R1 = 20 \text{ kW}$

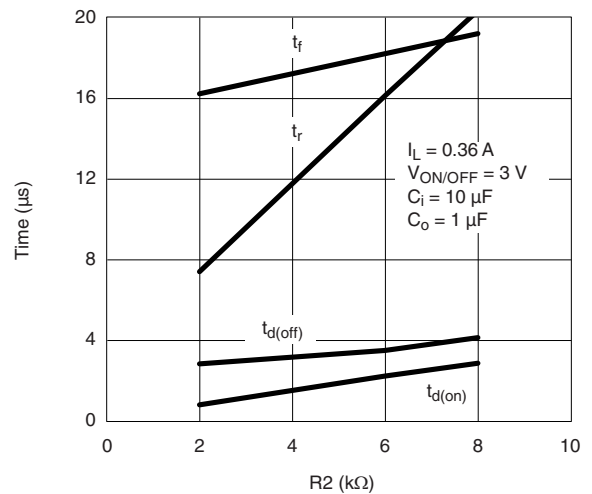

Switching Variation R2 at $V_{IN} = 1.8 \text{ V}$, $R1 = 20 \text{ kW}$

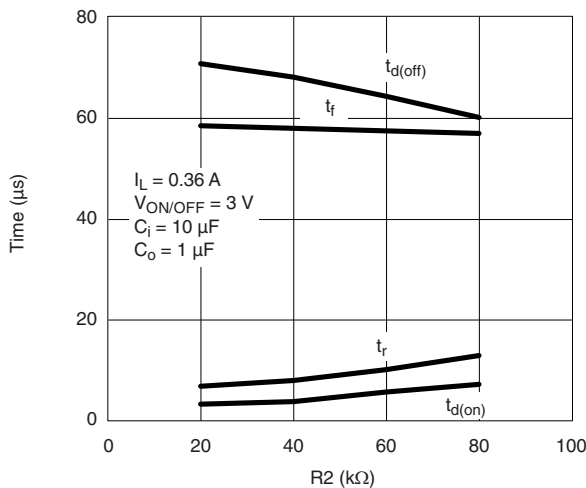

Switching Variation R2 at $V_{IN} = 4.5 \text{ V}$, $R1 = 300 \text{ kW}$

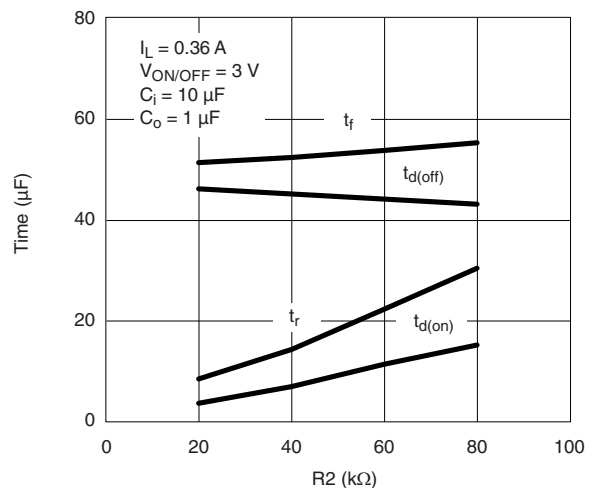

Switching Variation R2 at $V_{IN} = 2.5 \text{ V}$, $R1 = 300 \text{ kW}$

TYPICAL CHARACTERISTICS (25 °C, unless otherwise noted)

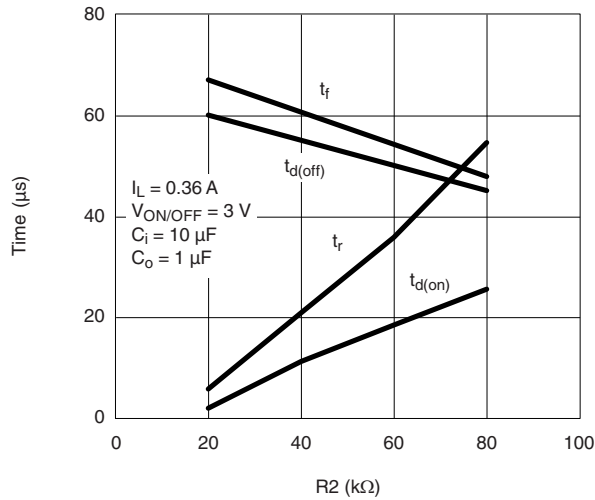

Switching Variation
 R_2 at $V_{IN} = 1.8 \text{ V}$, $R_1 = 300 \text{ k}\Omega$

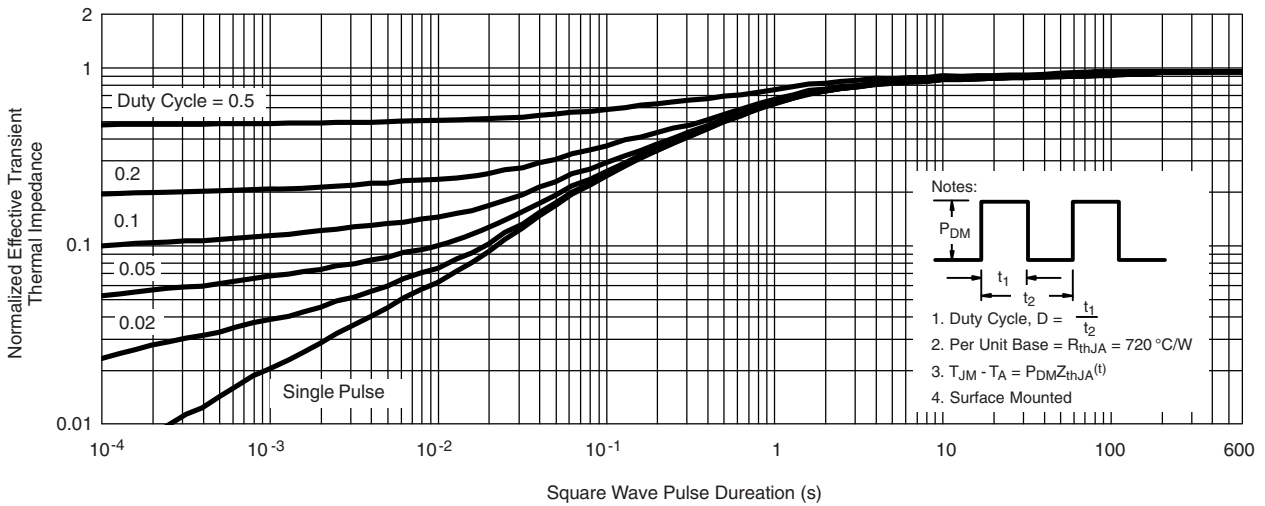

Vishay Siliconix maintains worldwide manufacturing capability. Products may be manufactured at one of several qualified locations. Reliability data for Silicon Technology and Package Reliability represent a composite of all qualified locations. For related documents such as package/tape drawings, part marking, and reliability data, see www.vishay.com/ppg?71809.

SC-89 6-Leads (SOT-563F)



Notes

1. Dimensions in millimeters.
- ⚠ Dimension D does not include mold flash, protrusions or gate burrs. Mold flash, protrusions or gate burrs shall not exceed 0.15 mm per dimension E1 does not include interlead flash or protrusion, interlead flash or protrusion shall not exceed 0.15 mm per side.
- ⚠ Dimensions D and E1 are determined at the outmost extremes of the plastic body exclusive of mold flash, the bar burrs, gate burrs and interlead flash, but including any mismatch between the top and the bottom of the plastic body.
- ⚠ Datums A, B and D to be determined 0.10 mm from the lead tip.
- ⚠ Terminal numbers are shown for reference only.
- ⚠ These dimensions apply to the flat section of the lead between 0.08 mm and 0.15 mm from the lead tip.

| DIM. | MILLIMETERS | | |
|------|-------------|------|------|
| | MIN. | NOM. | MAX. |
| A | 0.56 | 0.58 | 0.60 |
| A1 | 0 | 0.02 | 0.10 |
| b | 0.15 | 0.22 | 0.30 |
| c | 0.10 | 0.14 | 0.18 |
| D | 1.50 | 1.60 | 1.70 |
| E | 1.50 | 1.60 | 1.70 |
| E1 | 1.15 | 1.20 | 1.25 |
| e | 0.45 | 0.50 | 0.55 |
| e1 | 0.95 | 1.00 | 1.05 |
| L | 0.25 | 0.35 | 0.50 |
| L1 | 0.10 | 0.20 | 0.30 |

C14-0439-Rev. C, 11-Aug-14
DWG: 5880

RECOMMENDED MINIMUM PADS FOR SC-89: 6-Lead



Recommended Minimum Pads
Dimensions in Inches/(mm)

[Return to Index](#)



Disclaimer

ALL PRODUCT, PRODUCT SPECIFICATIONS AND DATA ARE SUBJECT TO CHANGE WITHOUT NOTICE TO IMPROVE RELIABILITY, FUNCTION OR DESIGN OR OTHERWISE.

Vishay Intertechnology, Inc., its affiliates, agents, and employees, and all persons acting on its or their behalf (collectively, "Vishay"), disclaim any and all liability for any errors, inaccuracies or incompleteness contained in any datasheet or in any other disclosure relating to any product.

Vishay makes no warranty, representation or guarantee regarding the suitability of the products for any particular purpose or the continuing production of any product. To the maximum extent permitted by applicable law, Vishay disclaims (i) any and all liability arising out of the application or use of any product, (ii) any and all liability, including without limitation special, consequential or incidental damages, and (iii) any and all implied warranties, including warranties of fitness for particular purpose, non-infringement and merchantability.

Statements regarding the suitability of products for certain types of applications are based on Vishay's knowledge of typical requirements that are often placed on Vishay products in generic applications. Such statements are not binding statements about the suitability of products for a particular application. It is the customer's responsibility to validate that a particular product with the properties described in the product specification is suitable for use in a particular application. Parameters provided in datasheets and / or specifications may vary in different applications and performance may vary over time. All operating parameters, including typical parameters, must be validated for each customer application by the customer's technical experts. Product specifications do not expand or otherwise modify Vishay's terms and conditions of purchase, including but not limited to the warranty expressed therein.

Except as expressly indicated in writing, Vishay products are not designed for use in medical, life-saving, or life-sustaining applications or for any other application in which the failure of the Vishay product could result in personal injury or death. Customers using or selling Vishay products not expressly indicated for use in such applications do so at their own risk. Please contact authorized Vishay personnel to obtain written terms and conditions regarding products designed for such applications.

No license, express or implied, by estoppel or otherwise, to any intellectual property rights is granted by this document or by any conduct of Vishay. Product names and markings noted herein may be trademarks of their respective owners.