

## Complementary 20 V (D-S) Low-Threshold MOSFET

PRODUCT SUMMARY			
	V <sub>DS</sub> (V)	R <sub>DS(on)</sub> (Ω)	I <sub>D</sub> (A)
N-Channel	20	0.280 at V <sub>GS</sub> = 4.5 V	1.28
		0.360 at V <sub>GS</sub> = 2.5 V	1.13
		0.450 at V <sub>GS</sub> = 1.8 V	1
P-Channel	- 20	0.490 at V <sub>GS</sub> = - 4.5 V	- 1
		0.750 at V <sub>GS</sub> = - 2.5 V	- 0.81
		1.10 at V <sub>GS</sub> = - 1.8 V	- 0.67

### FEATURES

- TrenchFET® Power MOSFETS: 1.8 V Rated
- ESD Protected: 2000 V
- Thermally Enhanced SC-70 Package
- Material categorization:  
For definitions of compliance please see [www.vishay.com/doc?99912](http://www.vishay.com/doc?99912)



**RoHS**  
COMPLIANT  
HALOGEN  
**FREE**  
Available

### APPLICATIONS

- Load Switching
- PA Switch
- Level Switch

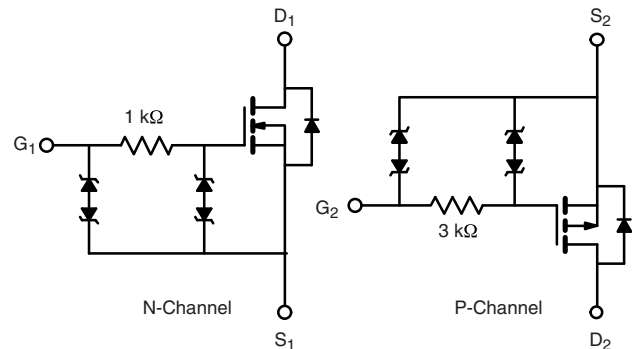
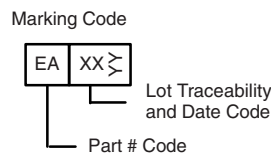
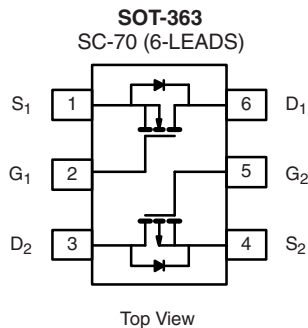

**Ordering Information:** Si1563EDH-T1-E3 (Lead (Pb)-free)  
Si1563EDH-T1-GE3 (Lead (Pb)-free and Halogen-free)

ABSOLUTE MAXIMUM RATINGS (T <sub>A</sub> = 25 °C, unless otherwise noted)							
Parameter	Symbol	N-Channel		P-Channel		Unit	
		5 s	Steady State	5 s	Steady State		
Drain-Source Voltage	V <sub>DS</sub>	20		- 20		V	
Gate-Source Voltage	V <sub>GS</sub>	± 12		± 12			
Continuous Drain Current (T <sub>J</sub> = 150 °C)	I <sub>D</sub>	T <sub>A</sub> = 25 °C	1.28	1.13	- 1	- 0.88	A
		T <sub>A</sub> = 85 °C	0.92	0.81	- 0.72	- 0.63	
Pulsed Drain Current	I <sub>DM</sub>	4		- 3			
Continuous Source Current (Diode Conduction) <sup>a</sup>	I <sub>S</sub>	0.61	0.48	- 0.61	- 0.48		
Maximum Power Dissipation <sup>a</sup>	P <sub>D</sub>	T <sub>A</sub> = 25 °C	0.74	0.57	0.30	0.57	W
		T <sub>A</sub> = 85 °C	0.38	0.30	0.16	0.3	
Operating Junction and Storage Temperature Range	T <sub>J</sub> , T <sub>stg</sub>	- 55 to 150				°C	

THERMAL RESISTANCE RATINGS					
Parameter		Symbol	Typical	Maximum	Unit
Maximum Junction-to-Ambient <sup>a</sup>	t ≤ 5 s	R <sub>thJA</sub>	130	170	°C/W
	Steady State		170	220	
Maximum Junction-to-Foot (Drain)	Steady State	R <sub>thJF</sub>	80	100	

Notes:

a. Surface mounted on 1" x 1" FR4 board.

SPECIFICATIONS ( $T_J = 25\text{ }^\circ\text{C}$ , unless otherwise noted)							
Parameter	Symbol	Test Conditions		Min.	Typ.	Max.	Unit
<b>Static</b>							
Gate Threshold Voltage	$V_{GS(th)}$	$V_{DS} = V_{GS}, I_D = 100\text{ }\mu\text{A}$	N-Ch	0.45		1	V
		$V_{DS} = V_{GS}, I_D = -100\text{ }\mu\text{A}$	P-Ch	-0.45		-1	
Gate-Body Leakage	$I_{GSS}$	$V_{DS} = 0\text{ V}, V_{GS} = \pm 4.5\text{ V}$	N-Ch			$\pm 1$	$\mu\text{A}$
			P-Ch			$\pm 1$	
		$V_{DS} = 0\text{ V}, V_{GS} = \pm 12\text{ V}$	N-Ch			$\pm 10$	mA
			P-Ch			$\pm 10$	
Zero Gate Voltage Drain Current	$I_{DSS}$	$V_{DS} = 16\text{ V}, V_{GS} = 0\text{ V}$	N-Ch			1	$\mu\text{A}$
		$V_{DS} = -16\text{ V}, V_{GS} = 0\text{ V}$	P-Ch			-1	
		$V_{DS} = 16\text{ V}, V_{GS} = 0\text{ V}, T_J = 85\text{ }^\circ\text{C}$	N-Ch			5	
		$V_{DS} = -16\text{ V}, V_{GS} = 0\text{ V}, T_J = 85\text{ }^\circ\text{C}$	P-Ch			-5	
On-State Drain Current <sup>a</sup>	$I_{D(on)}$	$V_{DS} \geq 5\text{ V}, V_{GS} = 4.5\text{ V}$	N-Ch	2			A
		$V_{DS} \leq -5\text{ V}, V_{GS} = -4.5\text{ V}$	P-Ch	-2			
Drain-Source On-State Resistance <sup>a</sup>	$R_{DS(on)}$	$V_{GS} = 4.5\text{ V}, I_D = 1.13\text{ A}$	N-Ch		0.220	0.280	$\Omega$
		$V_{GS} = -4.5\text{ V}, I_D = -0.88\text{ A}$	P-Ch		0.400	0.490	
		$V_{GS} = 2.5\text{ V}, I_D = 0.99\text{ A}$	N-Ch		0.281	0.360	
		$V_{GS} = -2.5\text{ V}, I_D = -0.71\text{ A}$	P-Ch		0.610	0.750	
		$V_{GS} = 1.8\text{ V}, I_D = 0.20\text{ A}$	N-Ch		0.344	0.450	
		$V_{GS} = -1.8\text{ V}, I_D = -0.20\text{ A}$	P-Ch		0.850	1.10	
Forward Transconductance <sup>a</sup>	$g_{fs}$	$V_{DS} = 10\text{ V}, I_D = 1.13\text{ A}$	N-Ch		2.6		S
		$V_{DS} = -10\text{ V}, I_D = -0.88\text{ A}$	P-Ch		1.5		
Diode Forward Voltage <sup>a</sup>	$V_{SD}$	$I_S = 0.48\text{ V}, V_{GS} = 0\text{ V}$	N-Ch		0.8	1.2	V
		$I_S = -0.48\text{ V}, V_{GS} = 0\text{ V}$	P-Ch		-0.8	-1.2	
<b>Dynamic<sup>b</sup></b>							
Total Gate Charge	$Q_g$	N-Channel $V_{DS} = 10\text{ V}, V_{GS} = 4.5\text{ V}, I_D = 1.13\text{ A}$  P-Channel $V_{DS} = -10\text{ V}, V_{GS} = -4.5\text{ V}, I_D = -0.88\text{ A}$	N-Ch		0.65	1	nC
			P-Ch		1.2	1.8	
Gate-Source Charge	$Q_{gs}$		N-Ch		0.2		
			P-Ch		0.3		
Gate-Drain Charge	$Q_{gd}$		N-Ch		0.23		
			P-Ch		0.3		
Turn-On Delay Time	$t_{d(on)}$	N-Channel $V_{DD} = 10\text{ V}, R_L = 20\text{ }\Omega$ $I_D \cong 0.5\text{ A}, V_{GEN} = 4.5\text{ V}, R_g = 6\text{ }\Omega$  P-Channel $V_{DD} = -10\text{ V}, R_L = 20\text{ }\Omega$ $I_D \cong -0.5\text{ A}, V_{GEN} = -4.5\text{ V}, R_g = 6\text{ }\Omega$	N-Ch		45	70	ns
			P-Ch		150	230	
Rise Time	$t_r$		N-Ch		85	130	
			P-Ch		480	720	
Turn-Off Delay Time	$t_{d(off)}$		N-Ch		350	530	
			P-Ch		840	1200	
Fall Time	$t_f$	N-Ch		210	320		
		P-Ch		850	1200		

Notes:

- a. Pulse test; pulse width  $\leq 300\text{ }\mu\text{s}$ , duty cycle  $\leq 2\%$ .  
b. Guaranteed by design, not subject to production testing.

Stresses beyond those listed under "Absolute Maximum Ratings" may cause permanent damage to the device. These are stress ratings only, and functional operation of the device at these or any other conditions beyond those indicated in the operational sections of the specifications is not implied. Exposure to absolute maximum rating conditions for extended periods may affect device reliability.

**N-CHANNEL TYPICAL CHARACTERISTICS** (25 °C, unless otherwise noted)

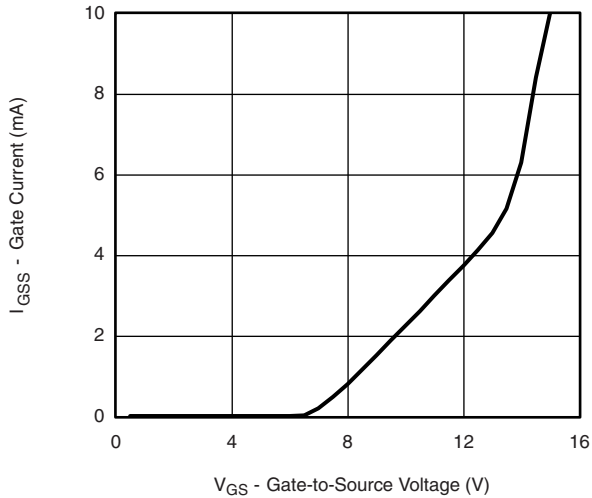

**Gate-Current vs. Gate-Source Voltage**

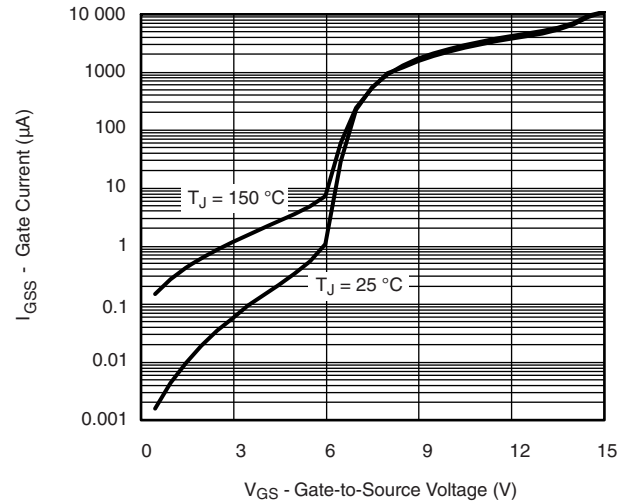

**Gate-Current vs. Gate-Source Voltage**

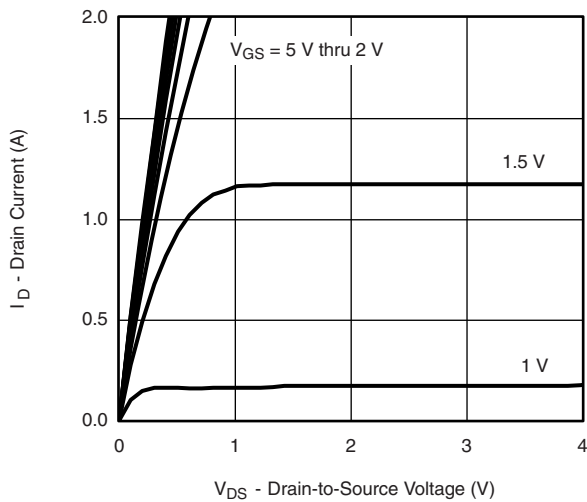

**Output Characteristics**

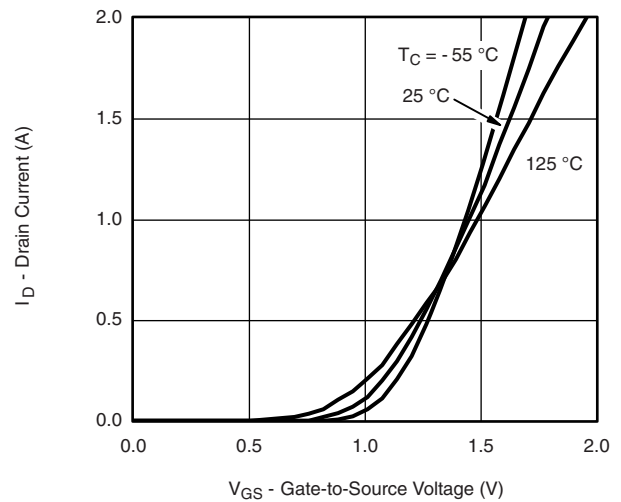

**Transfer Characteristics**

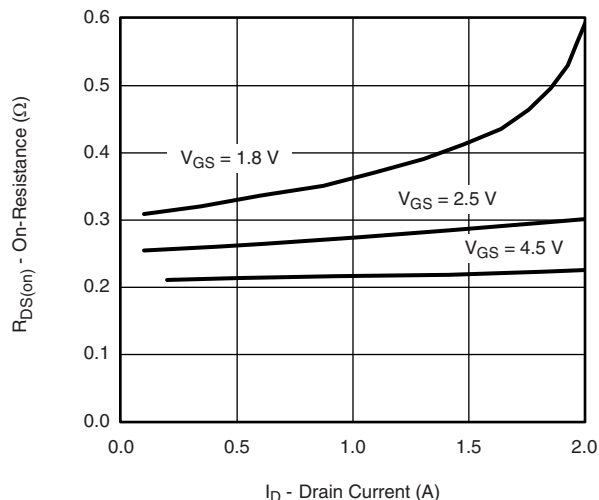

**On-Resistance vs. Drain Current**

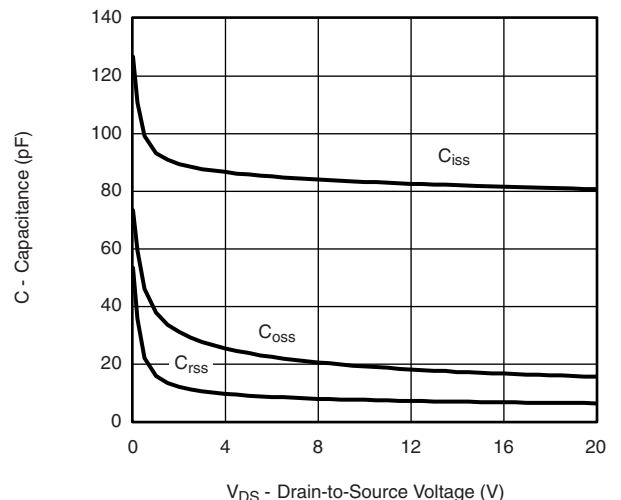

**Capacitance**

**N-CHANNEL TYPICAL CHARACTERISTICS** (25 °C, unless otherwise noted)

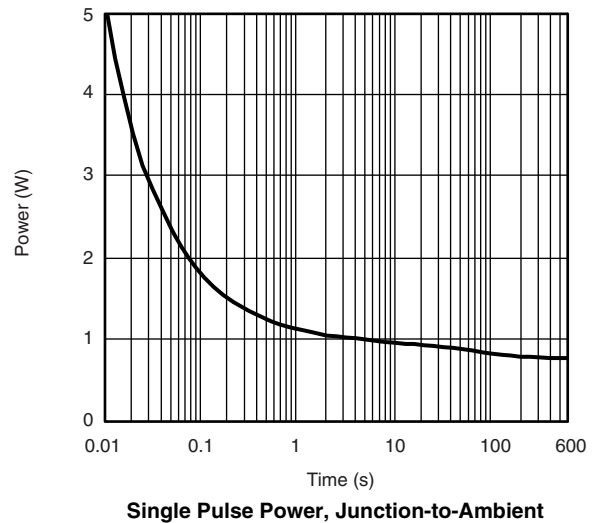
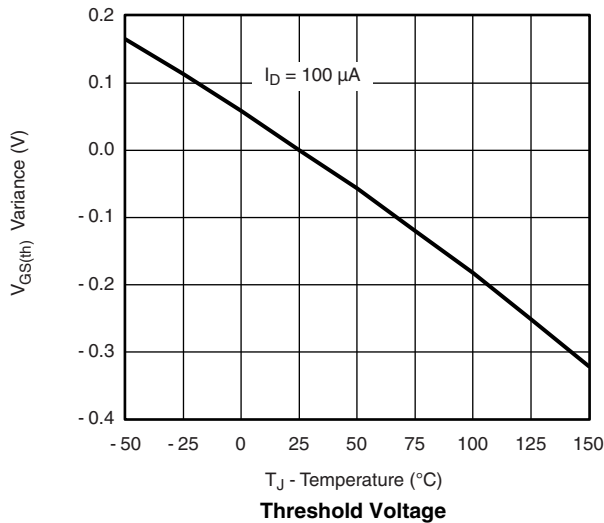
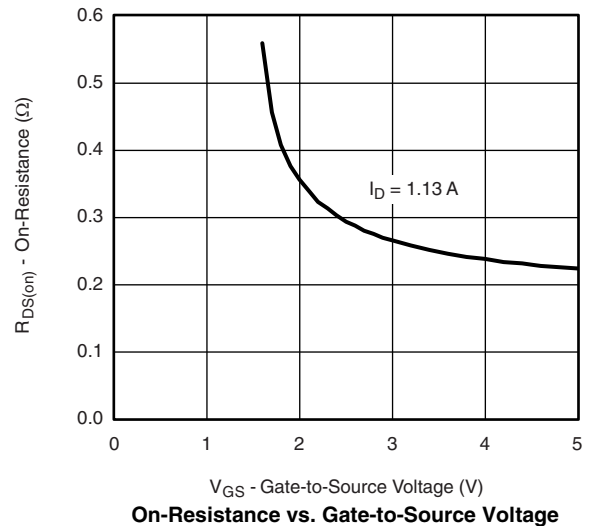
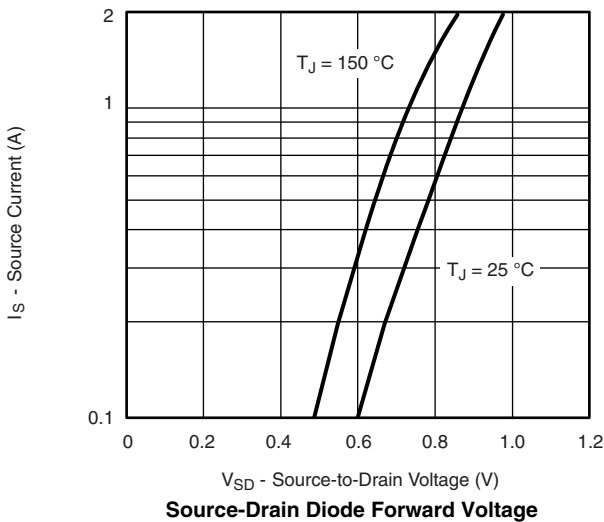
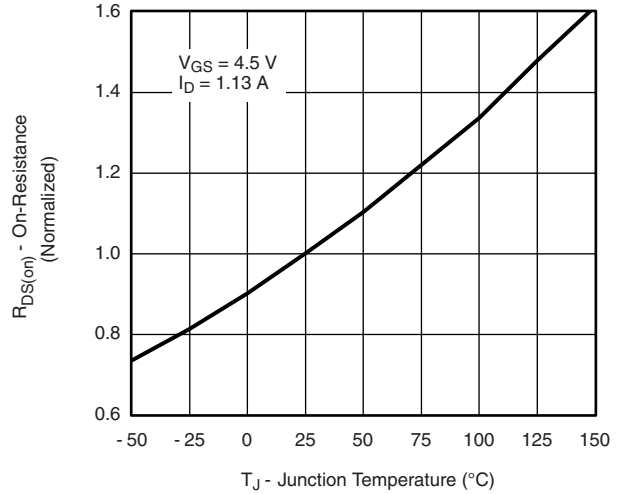
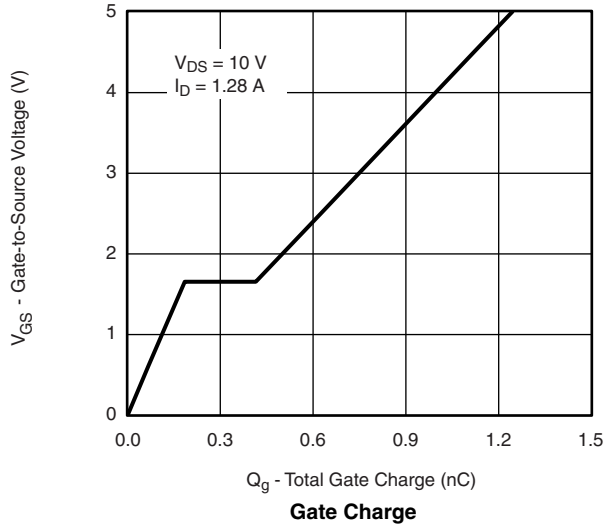

**N-CHANNEL TYPICAL CHARACTERISTICS** (25 °C, unless otherwise noted)

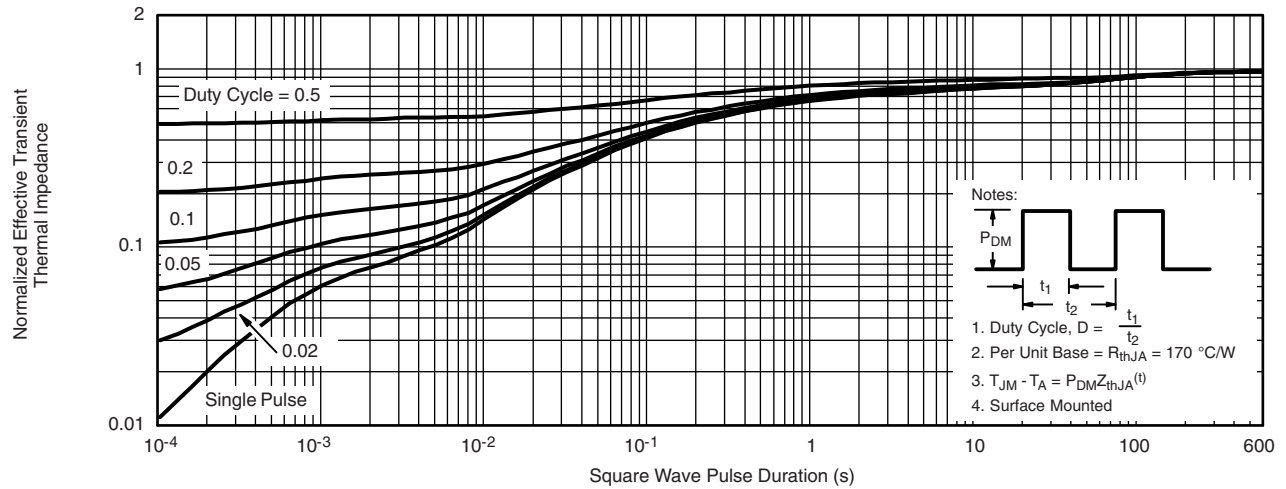

**Normalized Thermal Transient Impedance, Junction-to-Ambient**

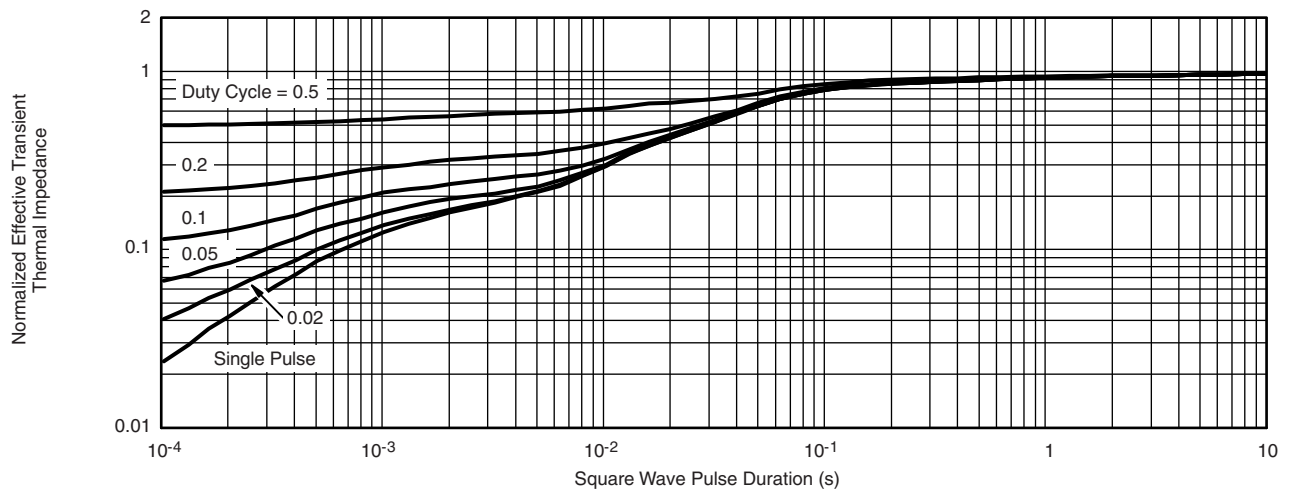

**Normalized Thermal Transient Impedance, Junction-to-Foot**

## P-CHANNEL TYPICAL CHARACTERISTICS (25 °C, unless otherwise noted)

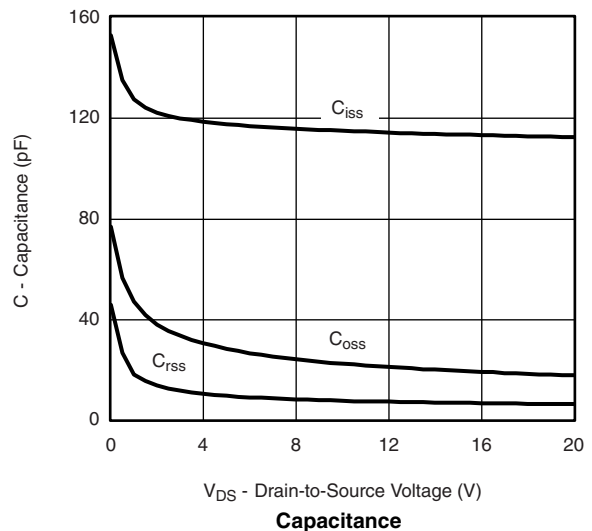
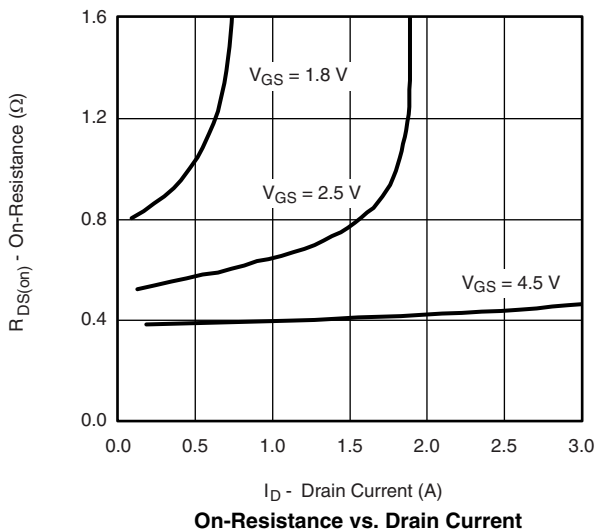
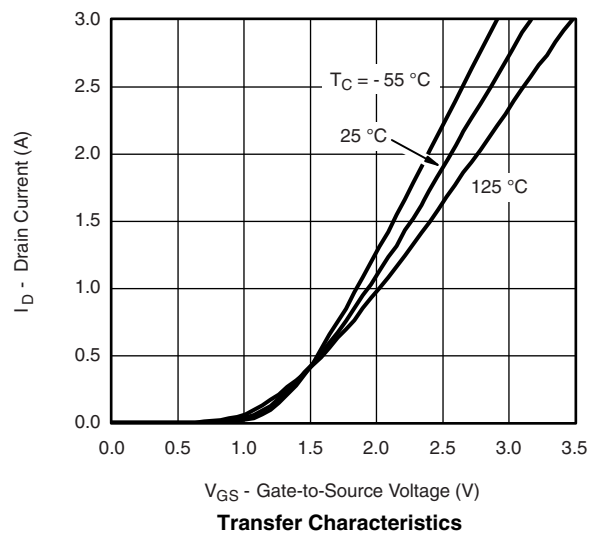
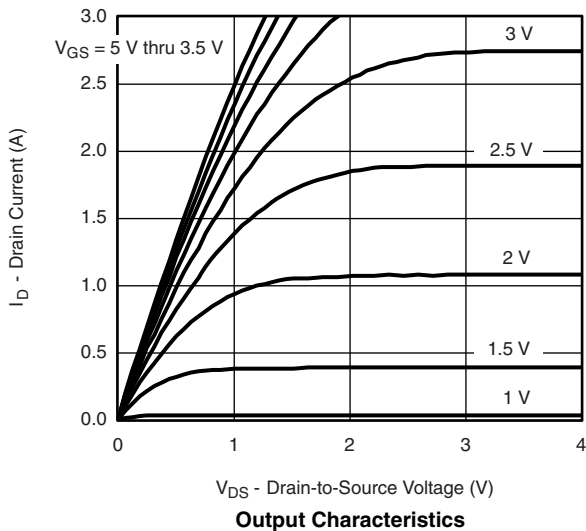
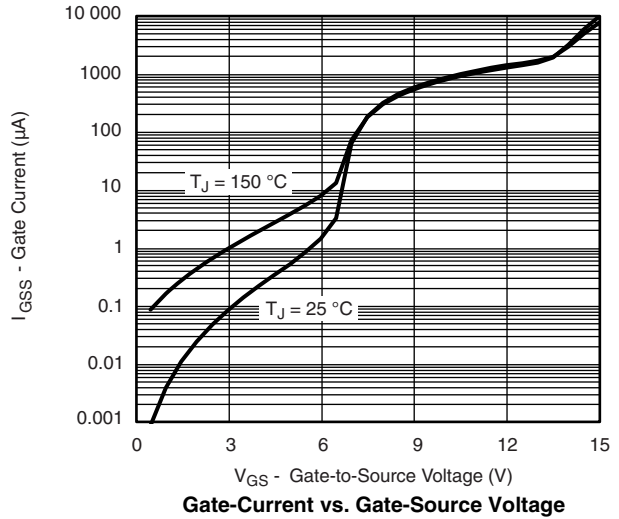
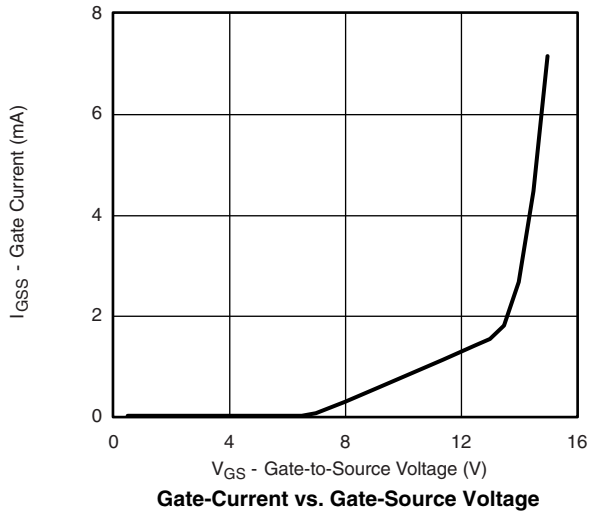

**P-CHANNEL TYPICAL CHARACTERISTICS** (25 °C, unless otherwise noted)

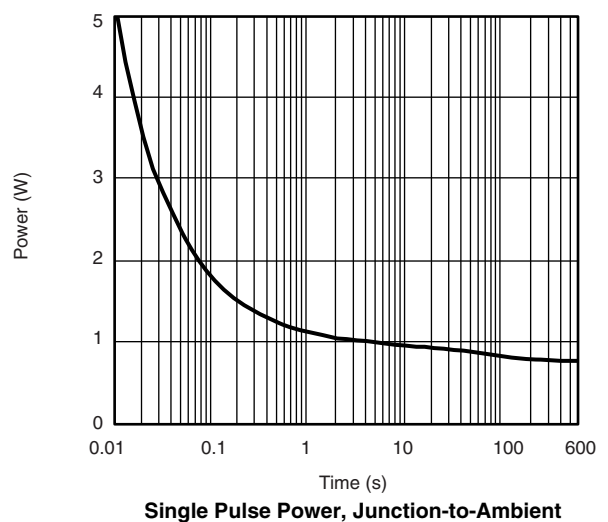
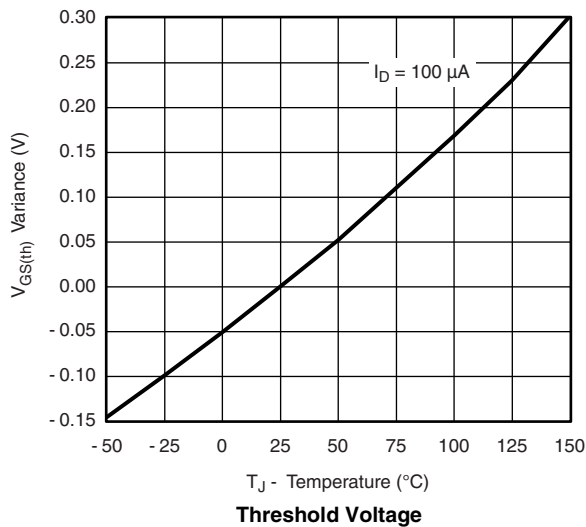
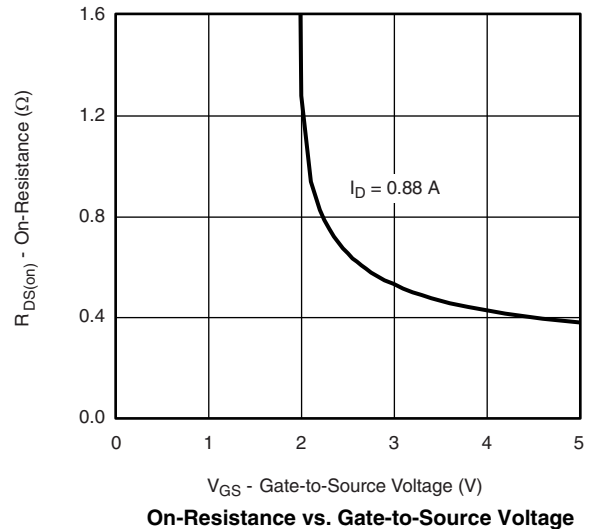
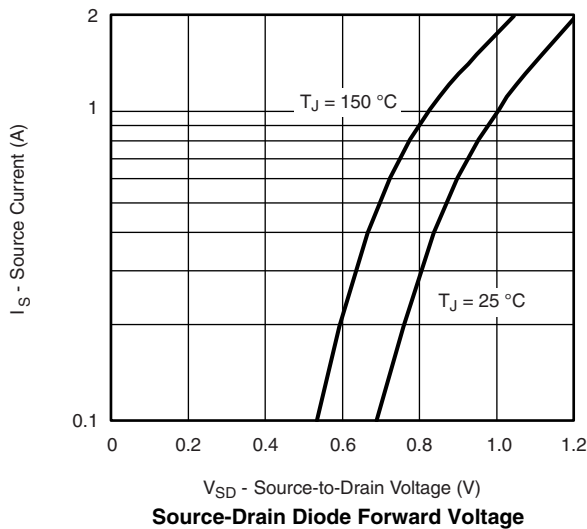
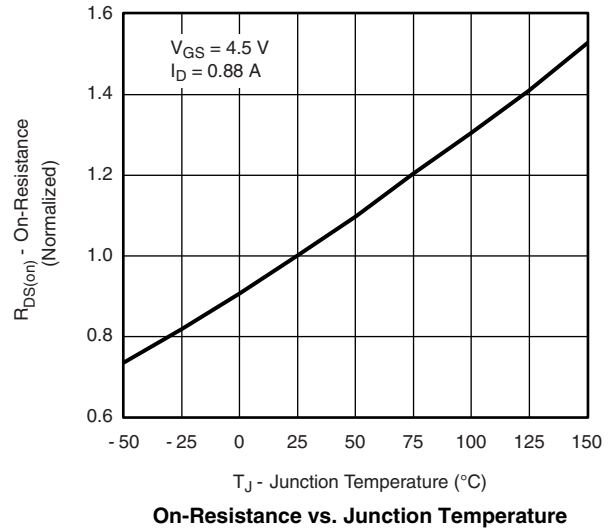
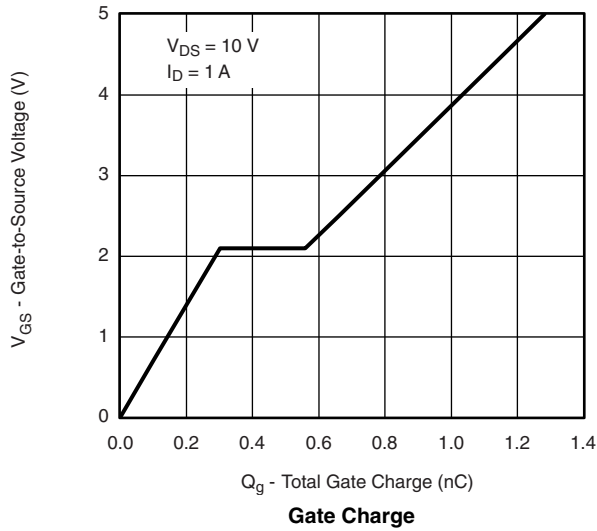

**P-CHANNEL TYPICAL CHARACTERISTICS** (25 °C, unless otherwise noted)

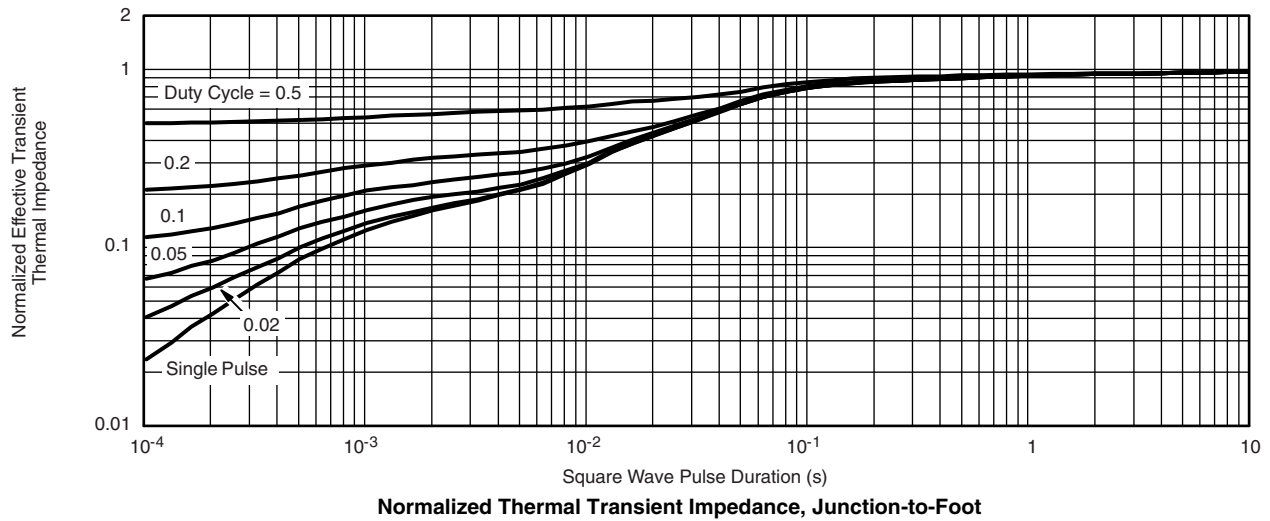
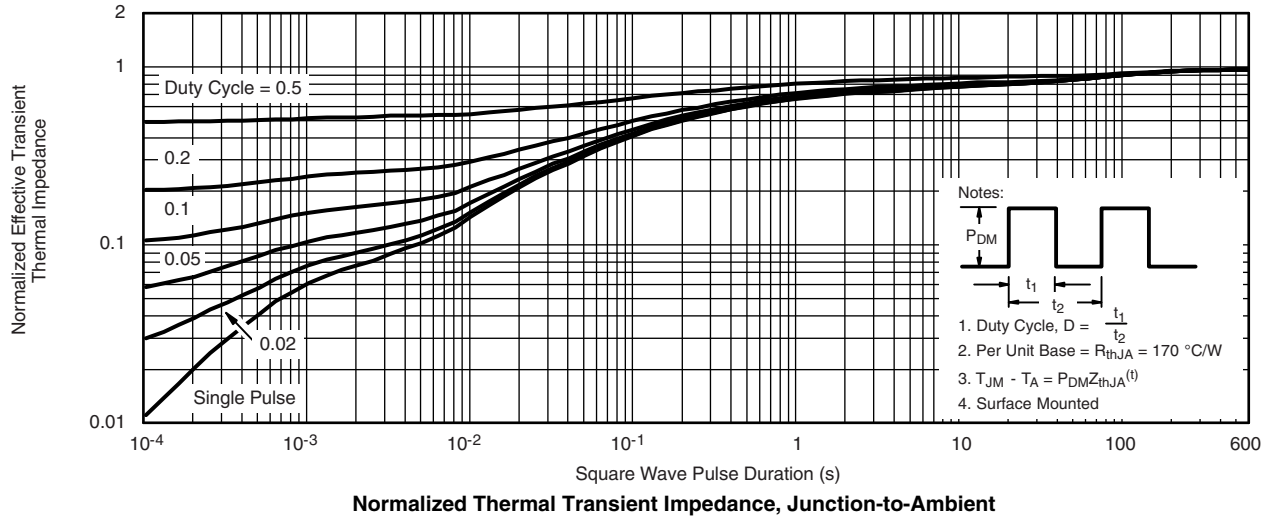

Vishay Siliconix maintains worldwide manufacturing capability. Products may be manufactured at one of several qualified locations. Reliability data for Silicon Technology and Package Reliability represent a composite of all qualified locations. For related documents such as package/tape drawings, part marking, and reliability data, see [www.vishay.com/ppg?71416](http://www.vishay.com/ppg?71416).





## **Disclaimer**

ALL PRODUCT, PRODUCT SPECIFICATIONS AND DATA ARE SUBJECT TO CHANGE WITHOUT NOTICE TO IMPROVE RELIABILITY, FUNCTION OR DESIGN OR OTHERWISE.

Vishay Intertechnology, Inc., its affiliates, agents, and employees, and all persons acting on its or their behalf (collectively, "Vishay"), disclaim any and all liability for any errors, inaccuracies or incompleteness contained in any datasheet or in any other disclosure relating to any product.

Vishay makes no warranty, representation or guarantee regarding the suitability of the products for any particular purpose or the continuing production of any product. To the maximum extent permitted by applicable law, Vishay disclaims (i) any and all liability arising out of the application or use of any product, (ii) any and all liability, including without limitation special, consequential or incidental damages, and (iii) any and all implied warranties, including warranties of fitness for particular purpose, non-infringement and merchantability.

Statements regarding the suitability of products for certain types of applications are based on Vishay's knowledge of typical requirements that are often placed on Vishay products in generic applications. Such statements are not binding statements about the suitability of products for a particular application. It is the customer's responsibility to validate that a particular product with the properties described in the product specification is suitable for use in a particular application. Parameters provided in datasheets and / or specifications may vary in different applications and performance may vary over time. All operating parameters, including typical parameters, must be validated for each customer application by the customer's technical experts. Product specifications do not expand or otherwise modify Vishay's terms and conditions of purchase, including but not limited to the warranty expressed therein.

Except as expressly indicated in writing, Vishay products are not designed for use in medical, life-saving, or life-sustaining applications or for any other application in which the failure of the Vishay product could result in personal injury or death. Customers using or selling Vishay products not expressly indicated for use in such applications do so at their own risk. Please contact authorized Vishay personnel to obtain written terms and conditions regarding products designed for such applications.

No license, express or implied, by estoppel or otherwise, to any intellectual property rights is granted by this document or by any conduct of Vishay. Product names and markings noted herein may be trademarks of their respective owners.