

Bi-Directional N-Channel 20-V (D-S) MOSFET

PRODUCT SUMMARY		
V _{S1S2} (V)	R _{S1S2(on)} (Ω)	I _{S1S2} (A)
20	0.024 at V _{GS} = 4.5 V	7
	0.026 at V _{GS} = 3.7 V	6.8
	0.034 at V _{GS} = 2.5 V	5.0
	0.040 at V _{GS} = 1.8 V	5.5

FEATURES

- TrenchFET® Power MOSFET
- Ultra-Low R_{SS(on)}
- ESD Protected: 4000 V
- MICRO FOOT® Chipscale Packaging
Reduces Footprint Area Profile (0.62 mm)
and On-Resistance Per Footprint Area



RoHS
COMPLIANT

APPLICATIONS

- Battery Protection Circuit
- 1-2 Cell Li+/LiP Battery Pack for Portable Devices

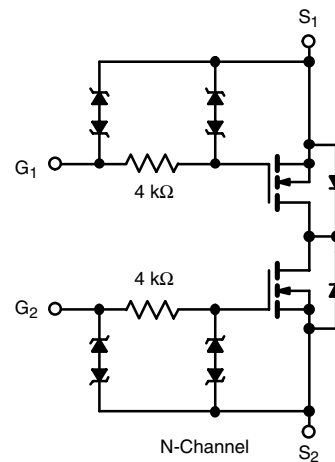
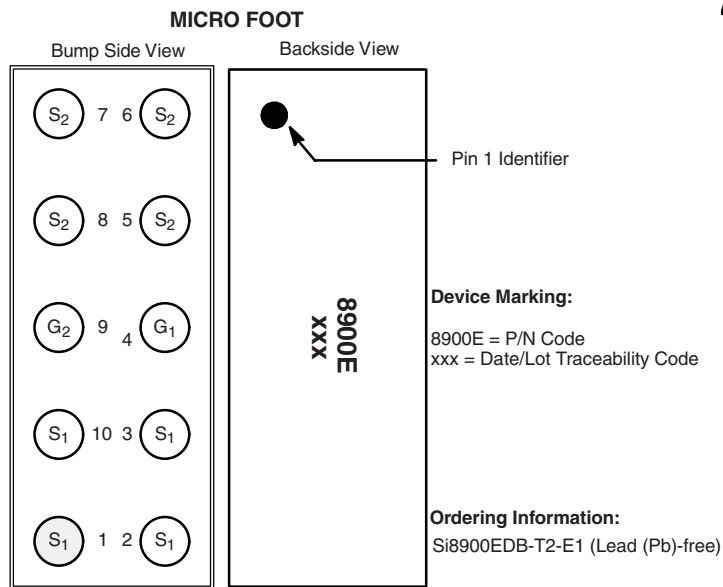

ABSOLUTE MAXIMUM RATINGS T _A = 25 °C, unless otherwise noted					
Parameter	Symbol	5 s	Steady State	Unit	
Source1- Source2 Voltage	V _{S1S2}	20		V	
Gate-Source Voltage	V _{GS}	± 12			
Continuous Source1- Source2 Current (T _J = 150 °C) ^a	I _{S1S2}	T _A = 25 °C	7	5.4	A
		T _A = 85 °C	5.1	3.9	
Pulsed Source1- Source2 Current	I _{SM}	50			
Maximum Power Dissipation ^a	P _D	T _A = 25 °C	1.8	1	W
		T _A = 85 °C	0.9	0.5	
Operating Junction and Storage Temperature Range	T _J , T _{stg}	- 55 to 150		°C	
Package Reflow Conditions ^c	IR/Convection	260			

THERMAL RESISTANCE RATINGS					
Parameter	Symbol	Typical	Maximum	Unit	
Maximum Junction-to-Ambient ^a	R _{thJA}	t ≤ 5 s	55	70	°C/W
		Steady State	95	120	
Maximum Junction-to-Foot ^b	R _{thJF}	12	15		

Notes:

- Surface Mounted on 1" x 1" FR4 board.
- The foot is defined as the top surface of the package.
- Refer to IPC/JEDEC (J-STD-020C), no manual or hand soldering.



SPECIFICATIONS $T_J = 25\text{ }^\circ\text{C}$, unless otherwise noted						
Parameter	Symbol	Test Conditions	Min.	Typ.	Max.	Unit
Static						
Gate Threshold Voltage	$V_{GS(th)}$	$V_{SS} = V_{GS}, I_D = 1.1\text{ mA}$	0.45		1.0	V
Gate-Body Leakage	I_{GSS}	$V_{SS} = 0\text{ V}, V_{GS} = \pm 4.5\text{ V}$			± 4	μA
		$V_{SS} = 0\text{ V}, V_{GS} = \pm 12\text{ V}$			± 10	mA
Zero Gate Voltage Drain Current	I_{S1S2}	$V_{SS} = 20\text{ V}, V_{GS} = 0\text{ V}$			1	μA
		$V_{SS} = 20\text{ V}, V_{GS} = 0\text{ V}, T_J = 85\text{ }^\circ\text{C}$			5	
On-State Drain Current ^a	$I_{S(on)}$	$V_{SS} = 5\text{ V}, V_{GS} = 4.5\text{ V}$	5			A
Source1- Source2 On State Resistance ^a	$R_{S1S2(on)}$	$V_{GS} = 4.5\text{ V}, I_{SS} = 1\text{ A}$		0.020	0.024	Ω
		$V_{GS} = 3.7\text{ V}, I_{SS} = 1\text{ A}$		0.022	0.026	
		$V_{GS} = 2.5\text{ V}, I_{SS} = 1\text{ A}$		0.026	0.034	
		$V_{GS} = 1.8\text{ V}, I_{SS} = 1\text{ A}$		0.032	0.040	
Forward Transconductance ^a	g_{fs}	$V_{SS} = 10\text{ V}, I_{SS} = 1\text{ A}$		31		S
Dynamic^b						
Turn-On Delay Time	$t_{d(on)}$	$V_{SS} = 10\text{ V}, R_L = 10\text{ }\Omega$ $I_{SS} \cong 1\text{ A}, V_{GEN} = 4.5\text{ V}, R_g = 6\text{ }\Omega$		3	5	μs
Rise Time	t_r			4.5	7	
Turn-Off Delay Time	$t_{d(off)}$			55	85	
Fall Time	t_f			15	25	

Notes:

- a. Pulse test; pulse width $\leq 300\text{ }\mu\text{s}$, duty cycle $\leq 2\%$.
- b. Guaranteed by design, not subject to production testing.

Stresses beyond those listed under "Absolute Maximum Ratings" may cause permanent damage to the device. These are stress ratings only, and functional operation of the device at these or any other conditions beyond those indicated in the operational sections of the specifications is not implied. Exposure to absolute maximum rating conditions for extended periods may affect device reliability.

TYPICAL CHARACTERISTICS $25\text{ }^\circ\text{C}$, unless otherwise noted

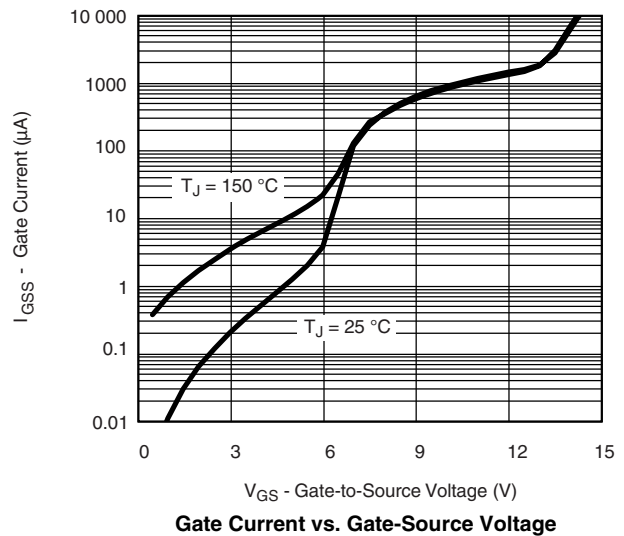
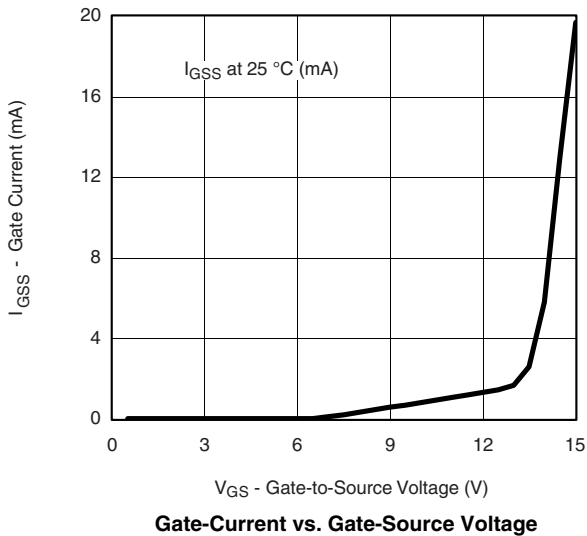

TYPICAL CHARACTERISTICS 25 °C, unless otherwise noted

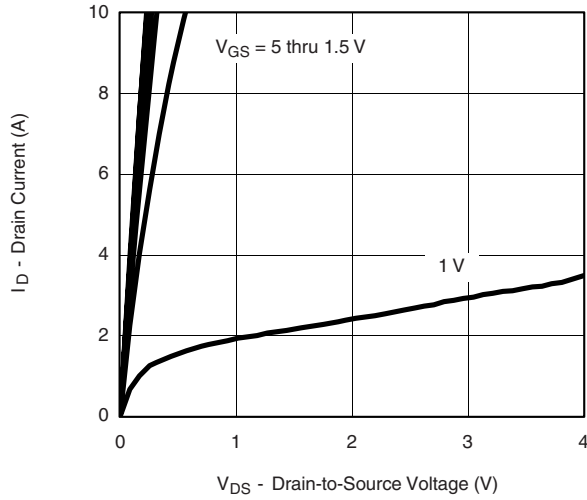

Output Characteristics

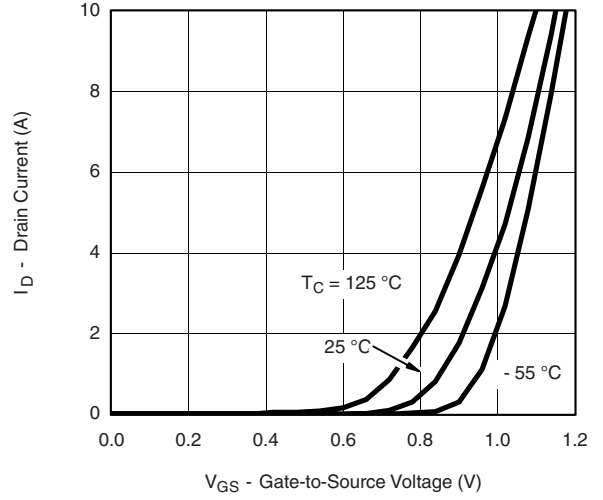

Transfer Characteristics

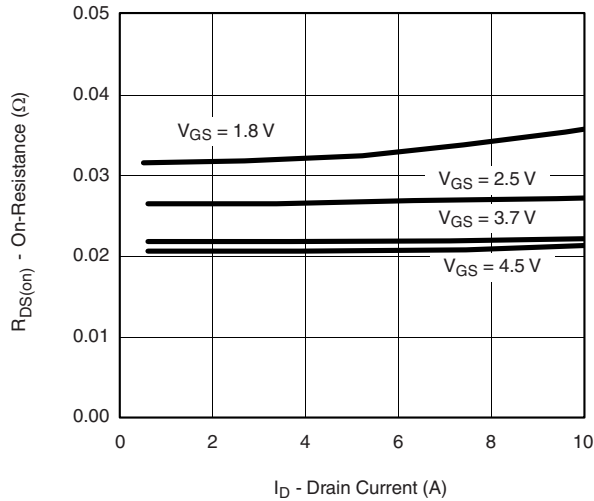

On-Resistance vs. Drain Current

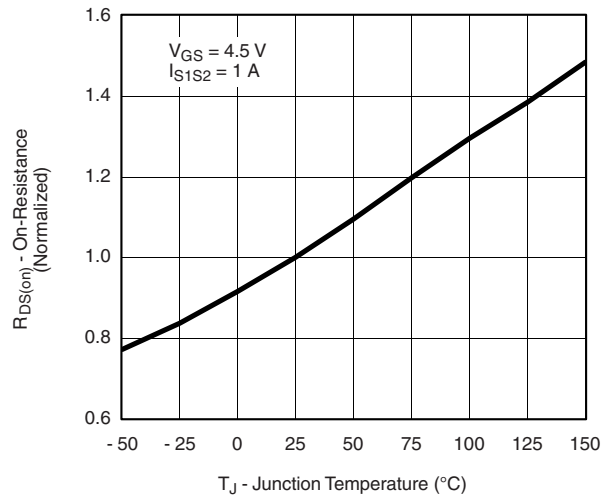

On-Resistance vs. Junction Temperature

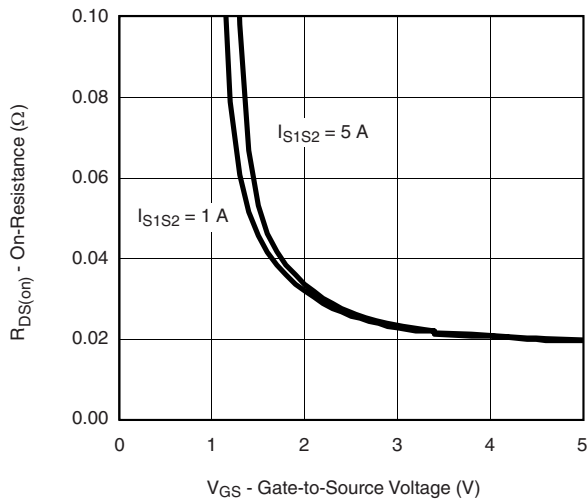

On-Resistance vs. Gate-to-Source Voltage

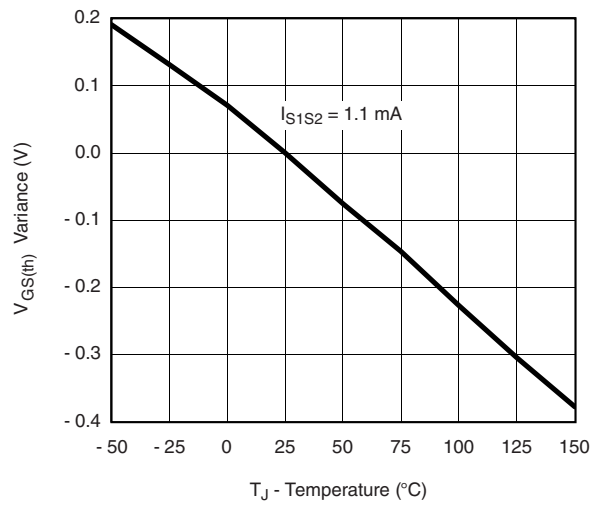

Threshold Voltage

TYPICAL CHARACTERISTICS 25 °C, unless otherwise noted

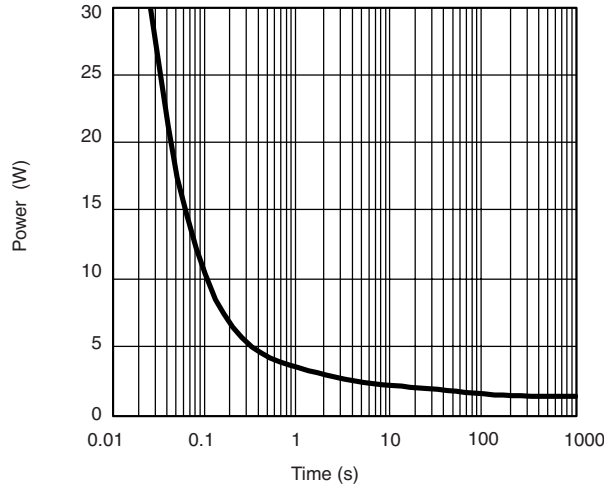

Single Pulse Power, Junction-to-Ambient

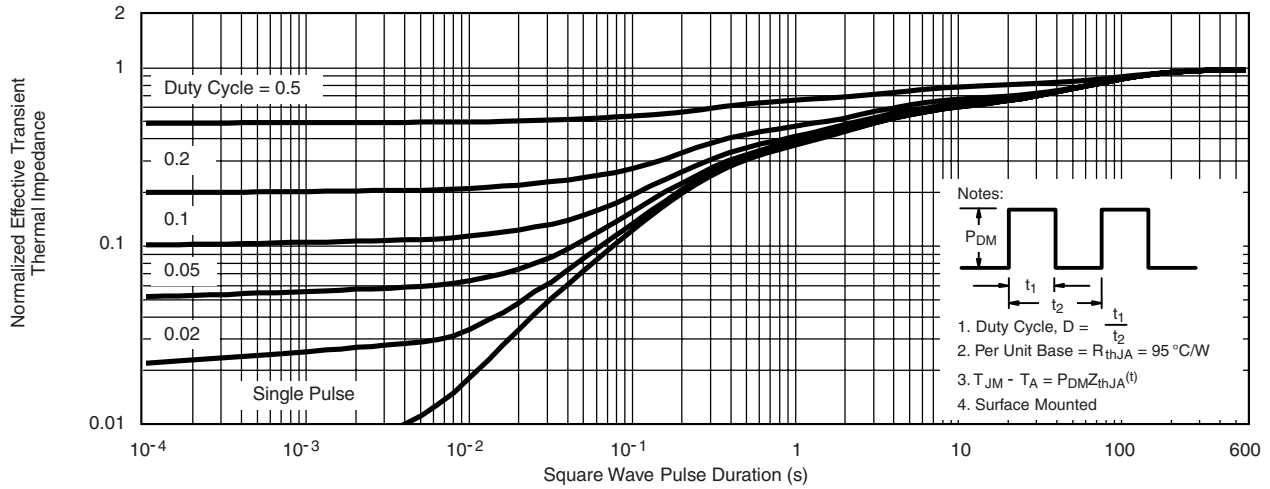

Normalized Thermal Transient Impedance, Junction-to-Ambient

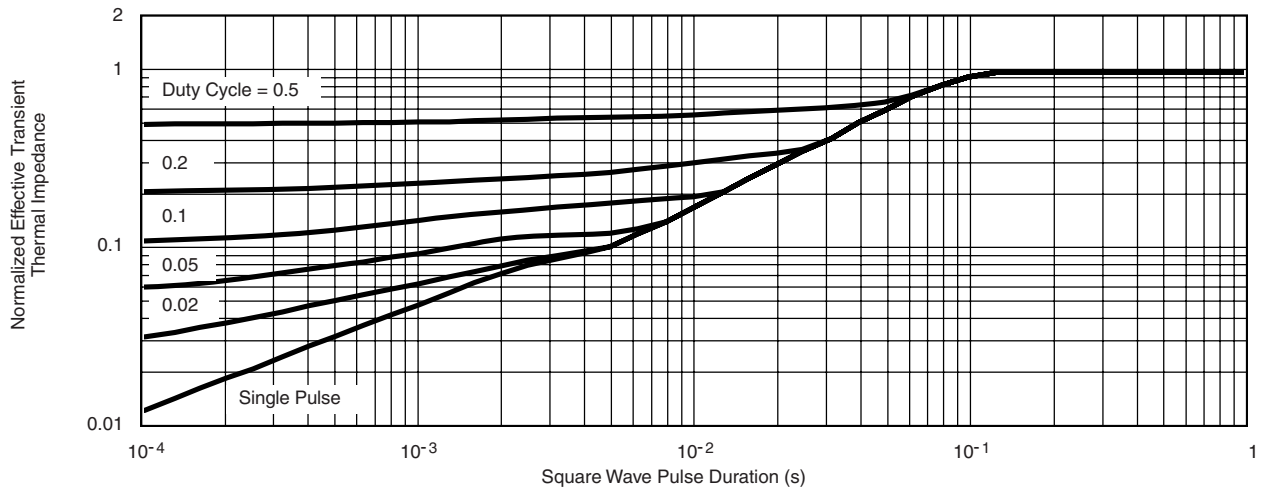

Normalized Thermal Transient Impedance, Junction-to-Foot

PACKAGE OUTLINE

MICRO FOOT: 10-BUMP (2 x 5, 0.8 mm PITCH)

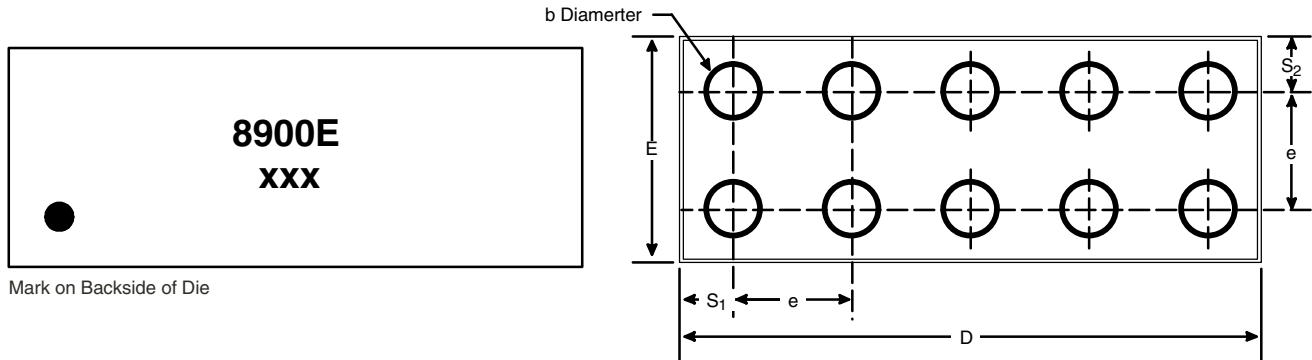
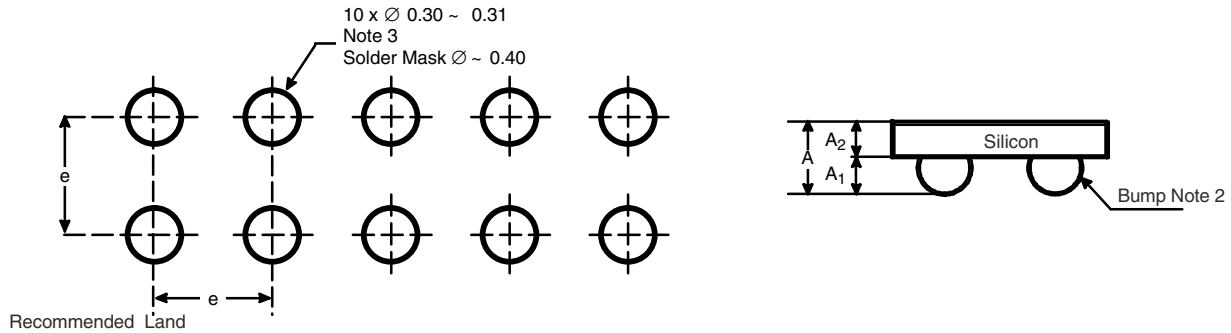

Notes (Unless Otherwise Specified):

1. Laser mark on the silicon die back, coated with a thin metal.
2. Bumps are 95.5Sn/3.8Ag/0.7Cu.
3. Non-solder mask defined copper landing pad.

Dim.	Millimeters ^a		Inches	
	Min.	Max.	Min.	Max.
A	0.600	0.650	0.0236	0.0256
A ₁	0.260	0.290	0.102	0.0114
A ₂	0.340	0.360	0.0134	0.0142
b	0.370	0.410	0.0146	0.0161
D	4.050	4.060	0.1594	0.1598
E	1.980	2.000	0.0780	0.0787
e	0.750	0.850	0.0295	0.0335
S ₁	0.430	0.450	0.0169	0.0177
S ₂	0.580	0.600	0.0228	0.0236

Notes:

- a. Use millimeters as the primary measurement.

Vishay Siliconix maintains worldwide manufacturing capability. Products may be manufactured at one of several qualified locations. Reliability data for Silicon Technology and Package Reliability represent a composite of all qualified locations. For related documents such as package/tape drawings, part marking, and reliability data, see <http://www.vishay.com/ppg?71830>.



Disclaimer

ALL PRODUCT, PRODUCT SPECIFICATIONS AND DATA ARE SUBJECT TO CHANGE WITHOUT NOTICE TO IMPROVE RELIABILITY, FUNCTION OR DESIGN OR OTHERWISE.

Vishay Intertechnology, Inc., its affiliates, agents, and employees, and all persons acting on its or their behalf (collectively, "Vishay"), disclaim any and all liability for any errors, inaccuracies or incompleteness contained in any datasheet or in any other disclosure relating to any product.

Vishay makes no warranty, representation or guarantee regarding the suitability of the products for any particular purpose or the continuing production of any product. To the maximum extent permitted by applicable law, Vishay disclaims (i) any and all liability arising out of the application or use of any product, (ii) any and all liability, including without limitation special, consequential or incidental damages, and (iii) any and all implied warranties, including warranties of fitness for particular purpose, non-infringement and merchantability.

Statements regarding the suitability of products for certain types of applications are based on Vishay's knowledge of typical requirements that are often placed on Vishay products in generic applications. Such statements are not binding statements about the suitability of products for a particular application. It is the customer's responsibility to validate that a particular product with the properties described in the product specification is suitable for use in a particular application. Parameters provided in datasheets and / or specifications may vary in different applications and performance may vary over time. All operating parameters, including typical parameters, must be validated for each customer application by the customer's technical experts. Product specifications do not expand or otherwise modify Vishay's terms and conditions of purchase, including but not limited to the warranty expressed therein.

Except as expressly indicated in writing, Vishay products are not designed for use in medical, life-saving, or life-sustaining applications or for any other application in which the failure of the Vishay product could result in personal injury or death. Customers using or selling Vishay products not expressly indicated for use in such applications do so at their own risk. Please contact authorized Vishay personnel to obtain written terms and conditions regarding products designed for such applications.

No license, express or implied, by estoppel or otherwise, to any intellectual property rights is granted by this document or by any conduct of Vishay. Product names and markings noted herein may be trademarks of their respective owners.