



Universal Input Switchmode Controller

FEATURES

- 10- to 450-V Input Range
- Current-Mode Control
- 125-mA Output Drive
- Internal Start-Up Circuit
- Internal Oscillator (1 MHz)
- SHUTDOWN and RESET

DESCRIPTION

The Si9120 is a BiC/DMOS integrated circuit designed for use in low-power, high-efficiency off-line power supplies. High-voltage DMOS inputs allow the controller to work over a wide range of input voltages (10- to 450-VDC). Current-mode PWM control circuitry is implemented in CMOS to reduce quiescent current to less than 1.5 mA.

to supply 30 W of output power at 100 kHz. These devices, when combined with an output MOSFET and transformer, can be used to implement single-ended power converter topologies (i.e., flyback and forward).

A CMOS output driver provides high-speed switching for MOSFET devices with gate charge, Q_g , up to 25 nC, enough

The Si9120 is available in both standard and lead (Pb)-free 16-pin plastic DIP and SOIC packages which are specified to operate over the industrial temperature range of -40°C to 85°C .

FUNCTIONAL BLOCK DIAGRAM

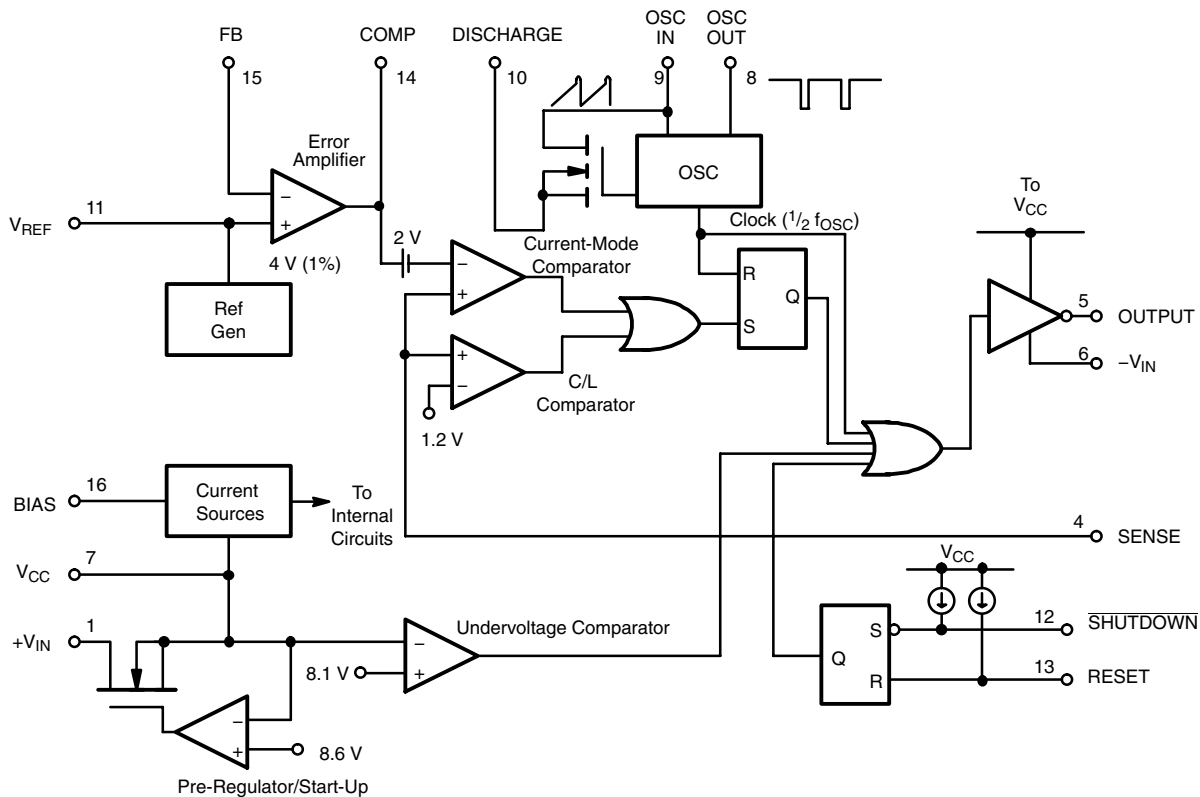

Applications information, see AN707 and AN708.



ABSOLUTE MAXIMUM RATINGS

Voltages Referenced to $-V_{IN}$ (Note: $V_{CC} < +V_{IN} + 0.3\text{ V}$)

V_{CC}	15 V
$+V_{IN}$	450 V
Logic Inputs (RESET SHUTDOWN, OSC IN, OSC OUT) Linear Input (FEEDBACK, SENSE, BIAS, V_{REF})	-0.3 V to $V_{CC} + 0.3\text{ V}$
HV Pre-Regulator Input Current (continuous)	5 mA ^a
Continuous Output Current (Source or Sink)	125 mA
Storage Temperature	-65 to 150°C
Operating Temperature	-40 to 85°C
Junction Temperature (T_J)	150°C

Power Dissipation (Package)^b

16-Pin Plastic DIP (J Suffix) ^c	750 mW
16-Pin SOIC (Y Suffix) ^d	900 mW
Thermal Impedance (Θ_{JA})	
16-Pin Plastic DIP	167°C/W
16-Pin SOIC	140°C/W

Notes

- Continuous current may be limited by the applications maximum input voltage and the package power dissipation.
- Device mounted with all leads soldered or welded to PC board.
- Derate 6 mW/°C above 25°C.
- Derate 7.2 mW/°C above 25°C.

Stresses beyond those listed under "Absolute Maximum Ratings" may cause permanent damage to the device. These are stress ratings only, and functional operation of the device at these or any other conditions beyond those indicated in the operational sections of the specifications is not implied. Exposure to absolute maximum rating conditions for extended periods may affect device reliability.

RECOMMENDED OPERATING RANGE

Voltages Referenced to $-V_{IN}$

V_{CC}	9.5 V to 13.5 V
$+V_{IN}$	10 V to 450 V
f_{OSC}	40 kHz to 1 MHz

R_{OSC}	25 k Ω to 1 M Ω
Linear Inputs	0 to $V_{CC} - 3\text{ V}$
Digital Inputs	0 to V_{CC}

SPECIFICATIONS ^a							
Parameter	Symbol	Specific Test Conditions DISCHARGE = $-V_{IN} = 0\text{ V}$, $V_{CC} = 10\text{ V}$ $+V_{IN} = 300\text{ V}$ $R_{BIAS} = 390\text{ k}\Omega$, $R_{OSC} = 330\text{ k}\Omega$	TEMP ^b	LIMITS D Suffix -40 to 85°C			Unit
				MIN ^c	TYP ^d	MAX ^c	
Reference							
Output Voltage	V_R	OSC IN = $-V_{IN}$ (OSC Disabled) $R_L = 10\text{ M}\Omega$	Room Full	3.88 3.82	4.0	4.12 4.14	V
Output Impedance ^e	Z_{OUT}		Room	15	30	45	k Ω
Short Circuit Current	I_{SREF}	$V_{REF} = -V_{IN}$	Room	70	100	130	μA
Temperature Stability ^e	T_{REF}		Full		0.5	1.0	mV/°C
Oscillator							
Maximum Frequency ^e	f_{MAX}	$R_{OSC} = 0$	Room	1	3		MHz
Initial Accuracy	f_{OSC}	C_{STRAY} Pin 9 $\leq 5\text{ pF}$ $R_{OSC} = 330\text{ k}\Omega$	Room	80	100	120	kHz
		C_{STRAY} Pin 9 $\leq 5\text{ pF}$ $R_{OSC} = 150\text{ k}\Omega$	Room	160	200	240	
Voltage Stability	$\Delta f/f$	$\Delta f/f = f(13.5\text{ V}) - f(9.5\text{ V}) / f(9.5\text{ V})$	Room		10	15	%
Temperature Coefficient ^e	T_{OSC}		Full		200	500	ppm/°C
Error Amplifier							
Feedback Input Voltage	V_{FB}	FB Tied to COMP OSC IN = $-V_{IN}$ (OSC Disabled)	Room	3.92		4.08	V
Input BIAS Current	I_{FB}	OSC IN = $-V_{IN}$, $V_{FB} = 4\text{ V}$	Room		25	500	nA
Input OFFSET Voltage	V_{OS}	OSC IN = $-V_{IN}$	Room		± 15	± 40	mV
Open Loop Voltage Gain ^e	A_{VOL}	OSC IN = $-V_{IN}$	Room	60	80		dB
Unity Gain Bandwidth ^e	BW	OSC IN = $-V_{IN}$	Room	1.0	1.5		MHz



SPECIFICATIONS ^a							
Parameter	Symbol	Specific Test Conditions DISCHARGE = $-V_{IN} = 0\text{ V}$, $V_{CC} = 10\text{ V} + V_{IN} = 300\text{ V}$, $R_{BIAS} = 390\text{ k}\Omega$, $R_{OSC} = 330\text{ k}\Omega$	TEMP ^b	LIMITS D Suffix -40 to 85°C			Unit
				MIN ^c	TYP ^d	MAX ^c	
Error Amplifier (Cont'd)							
Dynamic Output Impedance ^e	Z_{OUT}	Error Amp configured for 60 dB gain	Room		1000	2000	Ω
Output Current	I_{OUT}	Source $V_{FB} = 3.4\text{ V}$	Room		-2.0	-1.4	mA
		Sink $V_{FB} = 4.5\text{ V}$	Room	0.12	0.15		
Power Supply Rejection	PSRR	$9.5\text{ V} \leq V_{CC} \leq 13.5\text{ V}$	Room	50	70		dB
Current Limit							
Threshold Voltage	V_{SOURCE}	$V_{FB} = 0\text{ V}$	Room	1.0	1.2	1.4	V
Delay to Output ^e	t_d	$V_{SENSE} = 1.5\text{ V}$, See Figure 1	Room		100	150	ns
Pre-Regulator/Start-Up							
Input Voltage	$+V_{IN}$	$I_{IN} = 10\text{ }\mu\text{A}$	Room	450			V
Input Leakage Current	$+I_{IN}$	$V_{CC} \geq 9.4\text{ V}$	Room			10	μA
V_{CC} Pre-Regulator Turn-Off Threshold Voltage	V_{REG}	$I_{PRE-REGULATOR} = 10\text{ }\mu\text{A}$	Room	7.8	8.6	9.4	V
Undervoltage Lockout	V_{UVLO}		Room	7.0	8.1	8.9	
$V_{REG} - V_{UVLO}$	V_{DELTA}		Room	0.3	0.6		
Supply							
Supply Current	I_{CC}	$C_L = 500\text{ pF}$ at Pin 5	Room		0.85	1.5	mA
Bias Current	I_{BIAS}		Room	10	15	20	μA
Logic							
SHUTDOWN Delay ^e	t_{SD}	$C_L = 500\text{ pF}$, $V_{SENSE} = -V_{IN}$ See Figure 2	Room		50	100	ns
SHUTDOWN Pulse Width ^e	t_{SW}	See Figure 3	Room	50			
RESET Pulse Width ^e	t_{RW}		Room	50			
Latching Pulse Width SHUTDOWN and RESET Low ^e	t_{LW}		Room	25			
Input Low Voltage	V_{IL}		Room			2.0	V
Input High Voltage	V_{IH}		Room	8.0			
Input Current Input Voltage High	I_{IH}	$V_{IN} = 10\text{ V}$	Room		1	5	μA
Input Current Input Voltage Low	I_{IL}	$V_{IN} = 0\text{ V}$	Room	-35	-25		
Output							
Output High Voltage	V_{OH}	$I_{OUT} = -10\text{ mA}$	Room Full	9.7 9.5			V
Output Low Voltage	V_{OL}	$I_{OUT} = 10\text{ mA}$	Room Full			0.3 0.5	
Output Resistance	R_{OUT}	$I_{OUT} = 10\text{ mA}$, Source or Sink	Room Full		20 25	30 50	Ω
Rise Time ^e	t_r	$C_L = 500\text{ pF}$	Room		40	75	ns
Fall Time ^e	t_f		Room	40	75		

Notes

- Refer to PROCESS OPTION FLOWCHART for additional information.
- Room = 25°C, Cold and Hot = as determined by the operating temperature suffix.
- The algebraic convention whereby the most negative value is a minimum and the most positive a maximum, is used in this data sheet.
- Typical values are for DESIGN AID ONLY, not guaranteed nor subject to production testing.
- Guaranteed by design, not subject to production test.
- 250 V $\leq +V_{IN}$ 380 V place a 10-k Ω , 1/4-W resistor in series with a + V_{IN} (Pin1).
380 V $\leq +V_{IN}$ 450 V place a 15-k Ω , 1/4-W resistor in series with a + V_{IN} (Pin1).
Connect a 0.01- μF capacitor between + V_{IN} (Pin 1) and - V_{IN} (Pin 6).



TIMING WAVEFORMS

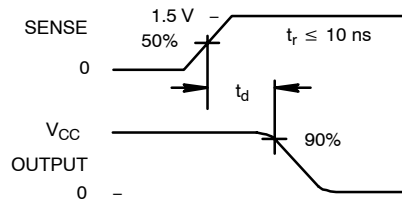

FIGURE 1.

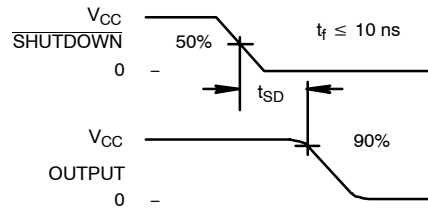

FIGURE 2.

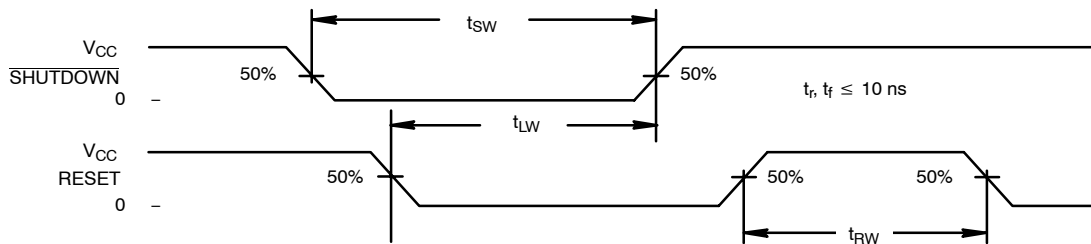
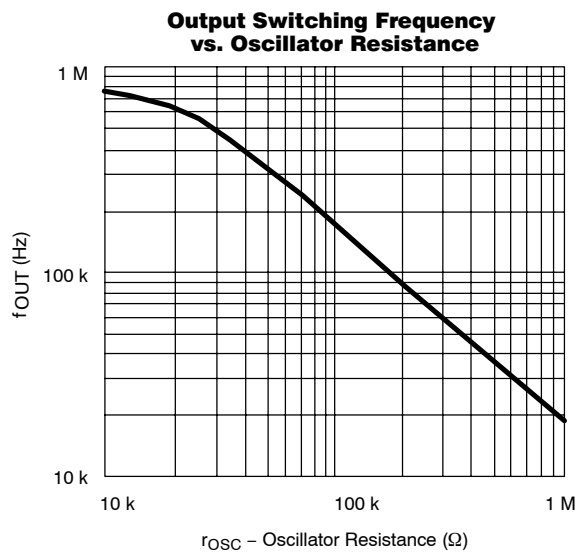
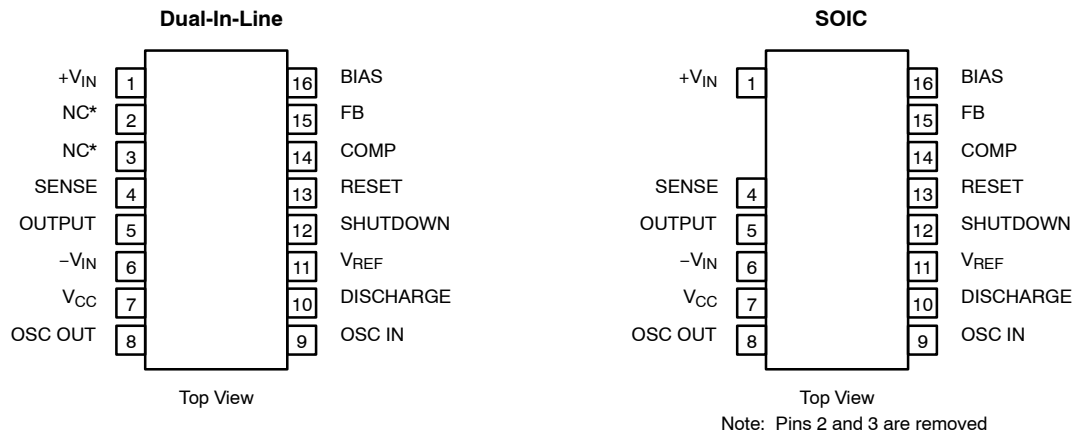

FIGURE 3.

TYPICAL CHARACTERISTICS



PIN CONFIGURATIONS AND ORDERING INFORMATION

ORDERING INFORMATION		
Part Number	Temperature Range	Package
Si9120DY	-40 to 85°C	SOIC-16
Si9120DY-T1		
Si9120DY-T1—E3		
Si9120DJ		
Si9120DJ—E3		PDIP-16

DETAILED DESCRIPTION
Pre-Regulator/Start-Up Section

Due to the low quiescent current requirement of the Si9120 control circuitry, bias power can be supplied from the unregulated input power source, from an external regulated low-voltage supply, or from an auxiliary “bootstrap” winding on the output inductor or transformer.

When power is first applied during start-up, $+V_{IN}$ (pin 1) will draw a constant current. The magnitude of this current is determined by a high-voltage depletion MOSFET which is connected between $+V_{IN}$ and V_{CC} (pin 7). This start-up circuitry provides initial power to the IC by charging an external bypass capacitance connected to the V_{CC} pin. The constant current is disabled when V_{CC} exceeds 8.6 V. If V_{CC} is not forced to exceed the 8.6-V threshold, then V_{CC} will be regulated to a nominal value of 8.6 V by the pre-regulator circuit.

As the supply voltage rises toward the normal operating conditions, an internal undervoltage (UV) lockout circuit keeps the output driver disabled until V_{CC} exceeds the undervoltage lockout threshold (typically 8.1 V). This guarantees that the

control logic will be functioning properly and that sufficient gate drive voltage is available before the MOSFET turns on. The design of the IC is such that the undervoltage lockout threshold will be at least 300 mV less than the pre-regulator turn-off voltage. Power dissipation can be minimized by providing an external power source to V_{CC} such that the constant current source is always disabled.

Note: When driving large MOSFETs at high frequency without a bootstrap V_{CC} supply, power dissipation in the pre-regulator may exceed the power rating of the IC package. For operation of $+V_{IN} > 250$ V, a 10-k Ω , 1/4-W resistor should be placed in series with $+V_{IN}$ (Pin 1). For $+V_{IN} > 380$ V, a 15-k Ω , 1/4-W resistor is recommended.

BIAS

To properly set the bias for the Si9120, a 390-k Ω resistor should be tied from BIAS (pin 16) to $-V_{IN}$ (pin 6). This determines the magnitude of bias current in all of the analog sections and the pull-up current for the $\overline{\text{SHUTDOWN}}$ and RESET pins. The current flowing in the bias resistor is nominally 15 μA .

DETAILED DESCRIPTION (CONT'D)

Reference Section

The reference section of the Si9120 consists of a temperature compensated buried zener and trimmable divider network. The output of the reference section is connected internally to the non-inverting input of the error amplifier. Nominal reference output voltage is 4 V. The trimming procedure that is used on the Si9120 brings the output of the error amplifier (which is configured for unity gain during trimming) to within $\pm 2\%$ of 4 V. This compensates for input offset voltage in the error amplifier.

The output impedance of the reference section has been purposely made high so that a low impedance external voltage source can be used to override the internal voltage source, if desired, without otherwise altering the performance of the device.

Error Amplifier

Closed-loop regulation is provided by the error amplifier, which is intended for use with "around-the-amplifier" compensation. A MOS differential input stage provides for high input impedance. The noninverting input to the error amplifier (V_{REF}) is internally connected to the output of the reference supply and should be bypassed with a small capacitor to ground.

Oscillator Section



The oscillator consists of a ring of CMOS inverters, capacitors, and a capacitor discharge switch. Frequency is set by an external resistor between the OSC IN and OSC OUT pins. (See Typical Characteristics for details of resistor value vs. frequency.) The DISCHARGE pin should be tied to $-V_{IN}$ for normal internal oscillator operation. A frequency divider in the logic section limits switch duty cycle to $\leq 50\%$ by locking the switching frequency to one half of the oscillator frequency.

SHUTDOWN and RESET

SHUTDOWN (pin 12) and RESET (pin 13) are intended for overriding the output MOSFET switch via external control logic. The two inputs are fed through a latch preceding the output switch. Depending on the logic state of RESET, SHUTDOWN can be either a latched or unlatched input. The output is off whenever SHUTDOWN is low. By simultaneously having SHUTDOWN and RESET low, the latch is set and SHUTDOWN has no effect until RESET goes high. See Table TABLE 1.

Both pins have internal current source pull-ups and should be left disconnected when not in use. An added feature of the current sources is the ability to connect a capacitor and an open-collector driver to the SHUTDOWN or RESET pins to provide variable shutdown time.

**TABLE 1.
TRUTH TABLE FOR SHUTDOWN AND
RESET PINS**

SHUTDOWN	RESET	OUTPUT
H	H	Normal Operation
H		Normal Operation (No Change)
L	H	Off (Not Latched)
L	L	Off (Latched)
	L	Off (Latched—No Change)

Output Driver

The push-pull driver output has a typical on-resistance of 20- Ω maximum switching times are specified at 75 ns for a 500-pF load. This is sufficient to directly drive MOSFETs such as the IRF820, BUZ78 or BUZ80. Larger devices can be driven, but switching times will be longer, resulting in higher switching losses.



SOIC (NARROW): 16-LEAD (POWER IC ONLY)
JEDEC Part Number: MS-012

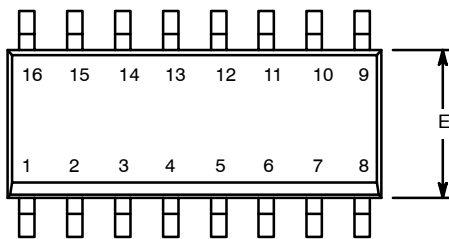

Dim	MILLIMETERS		INCHES	
	Min	Max	Min	Max
A	1.35	1.75	0.053	0.069
A ₁	0.10	0.20	0.004	0.008
B	0.38	0.51	0.015	0.020
C	0.18	0.23	0.007	0.009
D	9.80	10.00	0.385	0.393
E	3.80	4.00	0.149	0.157
e	1.27 BSC		0.050 BSC	
H	5.80	6.20	0.228	0.244
L	0.50	0.93	0.020	0.037
∅	0°	8°	0°	8°

ECN: S-40080—Rev. A, 02-Feb-04
DWG: 5912

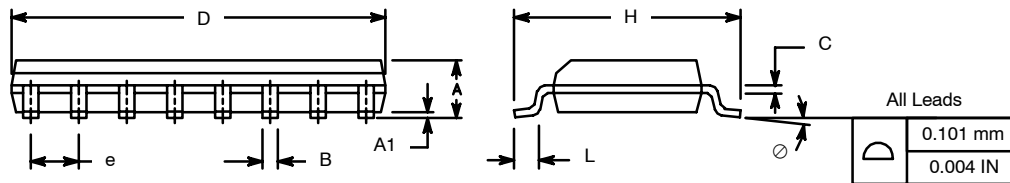

PDIP: 16-LEAD (POWER IC ONLY)

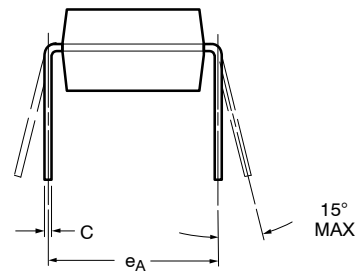
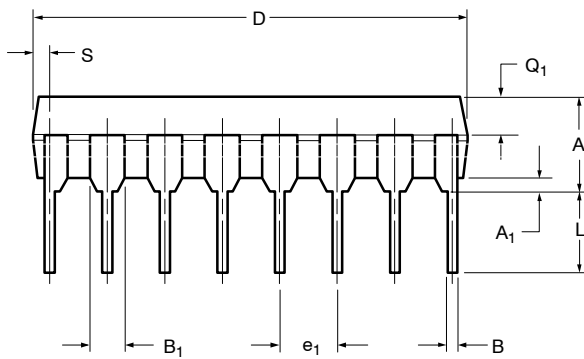
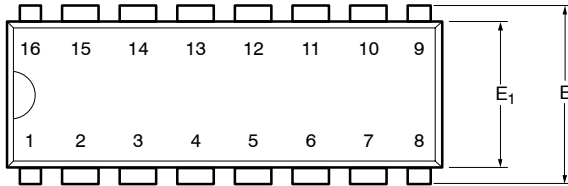

Dim	MILLIMETERS		INCHES	
	Min	Max	Min	Max
A	3.81	5.08	0.150	0.200
A₁	0.38	1.27	0.015	0.050
B	0.38	0.51	0.015	0.020
B₁	0.89	1.65	0.035	0.065
C	0.20	0.30	0.008	0.012
D	18.93	21.33	0.745	0.840
E	7.62	8.26	0.300	0.325
E₁	5.59	7.11	0.220	0.280
e₁	2.29	2.79	0.090	0.110
e_A	7.37	7.87	0.290	0.310
L	2.79	3.81	0.110	0.150
Q₁	1.27	2.03	0.050	0.080
S	0.38	1.52	.015	0.060

ECN: S-40081—Rev. A, 02-Feb-04
DWG: 5920



Disclaimer

ALL PRODUCT, PRODUCT SPECIFICATIONS AND DATA ARE SUBJECT TO CHANGE WITHOUT NOTICE TO IMPROVE RELIABILITY, FUNCTION OR DESIGN OR OTHERWISE.

Vishay Intertechnology, Inc., its affiliates, agents, and employees, and all persons acting on its or their behalf (collectively, "Vishay"), disclaim any and all liability for any errors, inaccuracies or incompleteness contained in any datasheet or in any other disclosure relating to any product.

Vishay makes no warranty, representation or guarantee regarding the suitability of the products for any particular purpose or the continuing production of any product. To the maximum extent permitted by applicable law, Vishay disclaims (i) any and all liability arising out of the application or use of any product, (ii) any and all liability, including without limitation special, consequential or incidental damages, and (iii) any and all implied warranties, including warranties of fitness for particular purpose, non-infringement and merchantability.

Statements regarding the suitability of products for certain types of applications are based on Vishay's knowledge of typical requirements that are often placed on Vishay products in generic applications. Such statements are not binding statements about the suitability of products for a particular application. It is the customer's responsibility to validate that a particular product with the properties described in the product specification is suitable for use in a particular application. Parameters provided in datasheets and / or specifications may vary in different applications and performance may vary over time. All operating parameters, including typical parameters, must be validated for each customer application by the customer's technical experts. Product specifications do not expand or otherwise modify Vishay's terms and conditions of purchase, including but not limited to the warranty expressed therein.

Except as expressly indicated in writing, Vishay products are not designed for use in medical, life-saving, or life-sustaining applications or for any other application in which the failure of the Vishay product could result in personal injury or death. Customers using or selling Vishay products not expressly indicated for use in such applications do so at their own risk. Please contact authorized Vishay personnel to obtain written terms and conditions regarding products designed for such applications.

No license, express or implied, by estoppel or otherwise, to any intellectual property rights is granted by this document or by any conduct of Vishay. Product names and markings noted herein may be trademarks of their respective owners.