

## 0.9 V to 2.5 V, 66 mΩ Load Switch in TDFN4

### DESCRIPTION

The SiP32501 is a compact, low  $R_{ON}$  turn on slew rate controlled load switch. The device has 66 mΩ resistance and operates over the input voltage range of 0.9 V to 2.5 V without requirement of extra bias power rail.

The SiP32501 has low input logic control threshold that can interface with low voltage control GPIO directly without extra level shift or driver. The switch supports designs when control logic voltage is higher than input power voltage. There is a pull down at this EN logic control pin.

The SiP32501 has 20 μs typically for input voltage of 1.2 V. Its turn off delay time is less than 1 μs. An output discharge switch is integrated.

SiP32501 is available in small TDFN4 package of 1.2 mm x 1.6 mm x 0.55 mm. The device is designed for the operation temperature range of -40 °C to +85 °C.

### FEATURES

- Low input voltage, 0.9 V to 2.5 V
- Low  $R_{ON}$ , 66 mΩ typical
- Fast turn on time
- Low quiescent current
- Low logic control with hysteresis
- Reverse current blocking when disabled
- Integrated pull down at EN pin
- Output discharge
- TDFN4 1.2 mm x 1.6 mm
- Material categorization: for definitions of compliance please see [www.vishay.com/doc?99912](http://www.vishay.com/doc?99912)



### APPLICATIONS

- Battery operated devices
- Smartphones and tablet
- Ultrabook and notebook
- Portable industrial equipment
- Medical and healthcare equipment
- Digital cameras
- Game console

### TYPICAL APPLICATION CIRCUIT

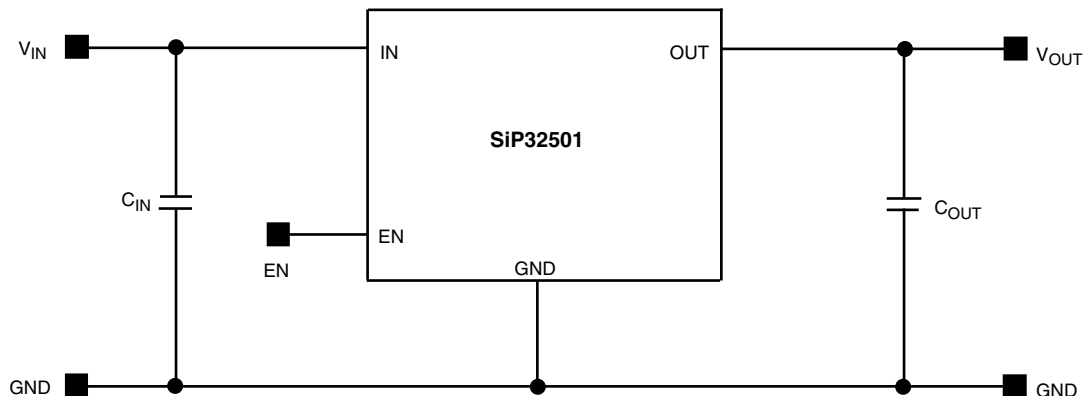

Fig. 1 - SiP32501 Typical Application Circuit

ORDERING INFORMATION			
TEMPERATURE RANGE	PACKAGE	MARKING	PART NUMBER
-40 °C to +85 °C	TDFN4 1.2 mm x 1.6 mm	Ux	SiP32501DNP-T1-GE4

#### Note

- -GE4 denotes halogen-free and RoHS-compliant



ABSOLUTE MAXIMUM RATINGS		
PARAMETER	LIMIT	UNIT
Supply input voltage ( $V_{IN}$ )	-0.3 to 2.75	V
Enable input voltage ( $V_{EN}$ )	-0.3 to 2.75	
Output voltage ( $V_{OUT}$ )	-0.3 to 2.75	
Maximum continuous switch current ( $I_{max}$ )	1.2	A
Maximum pulsed current ( $I_{DM}$ ) $V_{IN}$ (pulsed at 1 ms, 10 % duty cycle)	2	
ESD rating (HBM)	4000	V
Junction temperature ( $T_J$ )	-40 to +150	°C
Thermal resistance ( $\theta_{JA}$ ) <sup>a</sup>	170	°C/W
Power dissipation ( $P_D$ ) <sup>a</sup>	735	mW

**Notes**

- a. Device mounted with all leads and power pad soldered or welded to PC board
- b. Derate 5.9 mW/°C above  $T_A = 25\text{ °C}$

Stresses beyond those listed under "Absolute Maximum Ratings" may cause permanent damage to the device. These are stress ratings only, and functional operation of the device at these or any other conditions beyond those indicated in the operational sections of the specifications is not implied. Exposure to absolute maximum rating/conditions for extended periods may affect device reliability.

RECOMMENDED OPERATING RANGE		
PARAMETER	LIMIT	UNIT
Input voltage range ( $V_{IN}$ )	0.9 to 2.5	V
Operating junction temperature range	-40 to +125	°C

SPECIFICATIONS						
PARAMETER	SYMBOL	TEST CONDITIONS UNLESS SPECIFIED $V_{IN} = 1\text{ V}$ , $T_A = -40\text{ °C}$ to $+85\text{ °C}$ (Typical values are at $T_A = 25\text{ °C}$ )	LIMITS			UNIT
			MIN. <sup>a</sup>	TYP. <sup>b</sup>	MAX. <sup>a</sup>	
Operating voltage <sup>c</sup>	$V_{IN}$		0.9	-	2.5	V
Quiescent current	$I_Q$	$V_{IN} = 1.2\text{ V}$ , $V_{EN} = V_{IN}$ , OUT = open	-	10	15	$\mu\text{A}$
		$V_{IN} = 2.5\text{ V}$ , $V_{EN} = V_{IN}$ , OUT = open	-	34	60	
Off supply current	$I_{Q(off)}$	EN = GND, OUT = open	-	-	30	
Off switch current	$I_{DS(off)}$	EN = GND, OUT = 0 V	-	-	30	
Reverse blocking current	$I_{RB}$	$V_{OUT} = 2.5\text{ V}$ , $V_{IN} = 0.9\text{ V}$ , $V_{EN} = 0\text{ V}$	-	0.001	10	
On resistance	$R_{DS(on)}$	$V_{IN} = 1\text{ V}$ , $I_L = 200\text{ mA}$ , $T_A = 25\text{ °C}$	-	69	82	m $\Omega$
		$V_{IN} = 1.2\text{ V}$ , $I_L = 200\text{ mA}$ , $T_A = 25\text{ °C}$	-	68	82	
		$V_{IN} = 1.8\text{ V}$ , $I_L = 200\text{ mA}$ , $T_A = 25\text{ °C}$	-	66	80	
		$V_{IN} = 2.5\text{ V}$ , $I_L = 200\text{ mA}$ , $T_A = 25\text{ °C}$	-	66	80	
On resistance temp. coefficient	$TC_{RDS}$		-	4100	-	ppm/°C
Output pulldown resistance	$R_{PD}$	$V_{EN} = 0\text{ V}$ , $T_A = 25\text{ °C}$	-	425	550	$\Omega$
EN input low voltage <sup>c</sup>	$V_{IL}$	$V_{IN} = 1\text{ V}$	-	-	0.1	V
EN input high voltage <sup>c</sup>	$V_{IH}$	$V_{IN} = 2.5\text{ V}$	1.5	-	-	
EN input leakage	$I_{EN}$	$V_{IN} = 2.5\text{ V}$ , $V_{EN} = 0\text{ V}$	-	-	1	$\mu\text{A}$
		$V_{IN} = 2.5\text{ V}$ , $V_{EN} = 2.5\text{ V}$	-	10	15	
Output turn-on delay time	$t_{d(on)}$	$V_{IN} = 1.2\text{ V}$	-	0.4	1	$\mu\text{s}$
		$V_{IN} = 2.5\text{ V}$	-	0.05	1	
Output turn-on rise time	$t_r$	$V_{IN} = 1.2\text{ V}$	10	20	30	
		$V_{IN} = 2.5\text{ V}$	5	9.8	20	
Output turn-off delay time	$t_{d(off)}$	$V_{IN} = 1.2\text{ V}$	-	0.25	1	
		$V_{IN} = 2.5\text{ V}$	-	0.15	1	

**Notes**

- a. The algebraic convention whereby the most negative value is a minimum and the most positive a maximum.
- b. Typical values are for DESIGN AID ONLY, not guaranteed nor subject to production testing.
- c. For  $V_{IN}$  outside this range consult typical EN threshold curve.

**PIN CONFIGURATION**

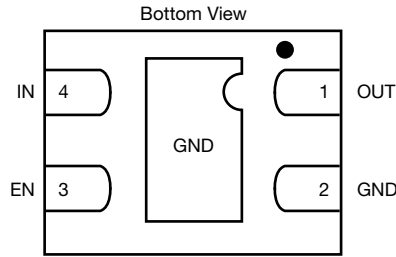

Fig. 2 - TDFN4 1.2 mm x 1.6 mm

PIN DESCRIPTION		
PIN NUMBER	NAME	FUNCTION
1	OUT	This pin is the n-channel MOSFET source connection. Bypass to ground through a 0.1 $\mu$ F capacitor
2	GND	Ground connection
3	EN	Enable input
4	IN	This pin is the n-channel MOSFET drain connection. Bypass to ground through a 4.7 $\mu$ F capacitor

**BLOCK DIAGRAM**

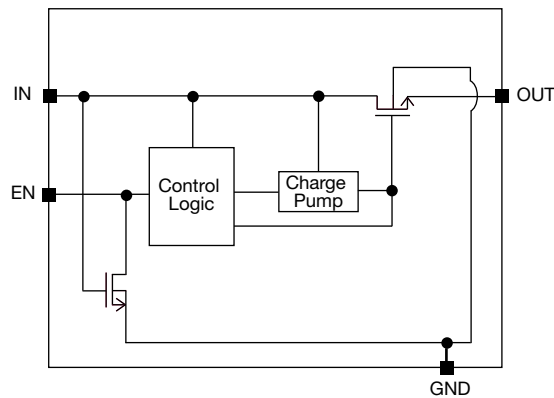

Fig. 3 - Functional Block Diagram

**TYPICAL CHARACTERISTICS** (internally regulated, 25 °C, unless otherwise noted)

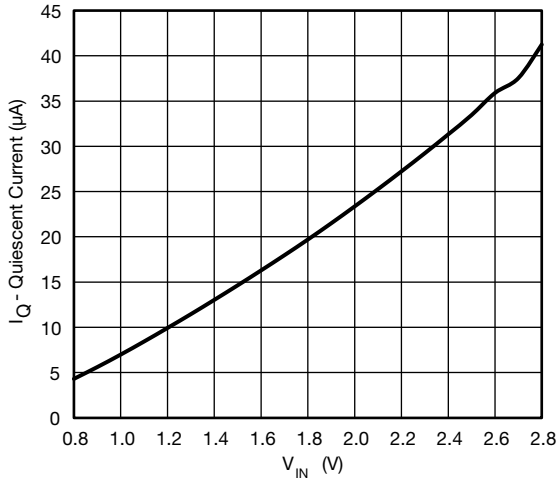

Fig. 4 - Quiescent Current vs. Input Voltage

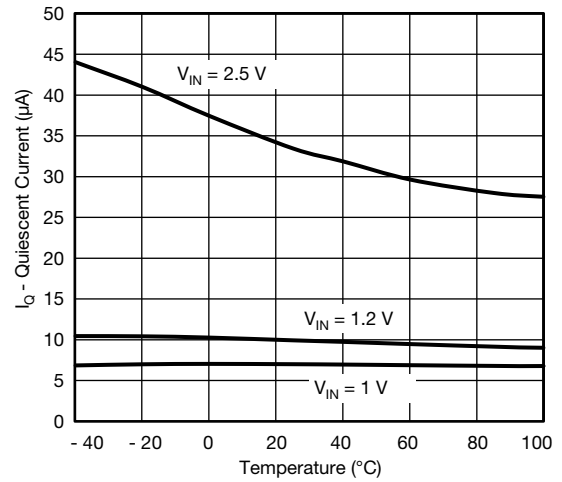

Fig. 7 - Quiescent Current vs. Temperature

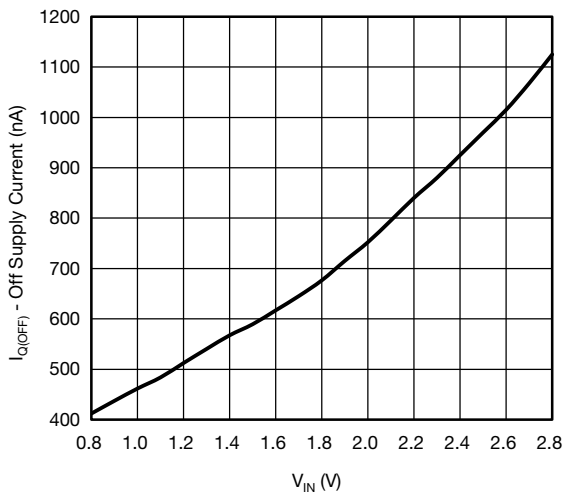

Fig. 5 - Off Supply Current vs. Input Voltage

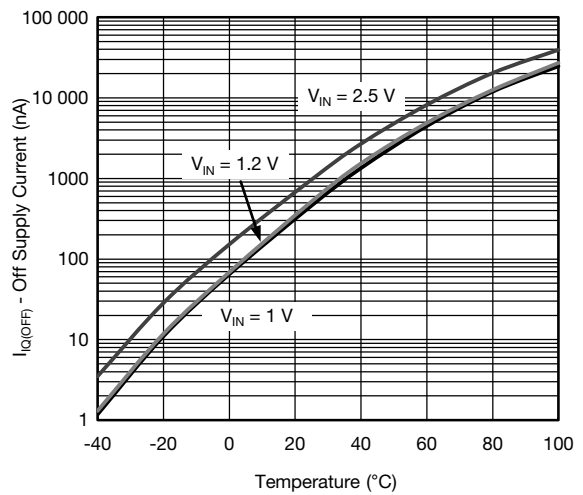

Fig. 8 - Off Supply Current vs. Temperature

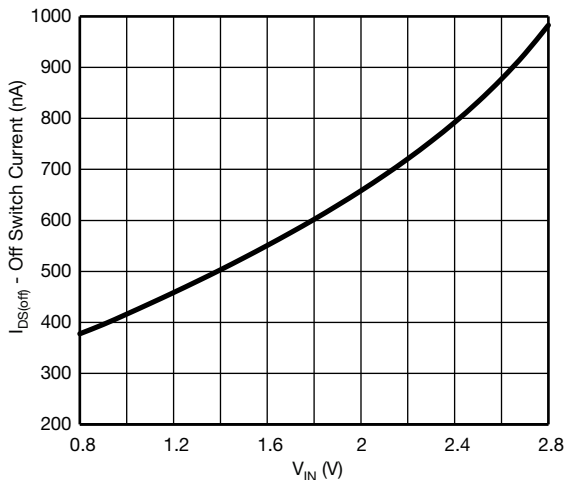

Fig. 6 - Off Switch Current vs. Input Voltage

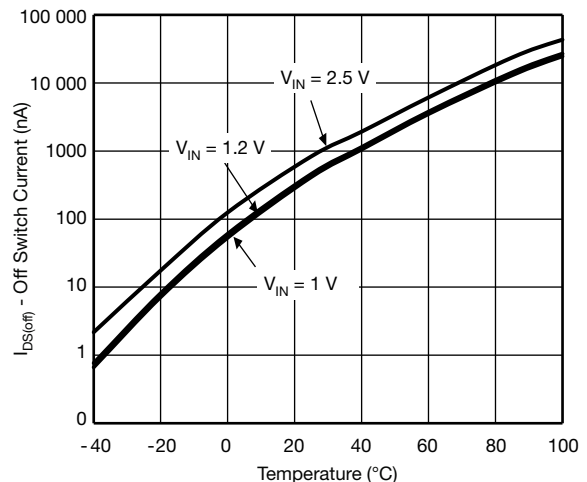

Fig. 9 - Off Switch Current vs. Temperature

**TYPICAL CHARACTERISTICS** (internally regulated, 25 °C, unless otherwise noted)

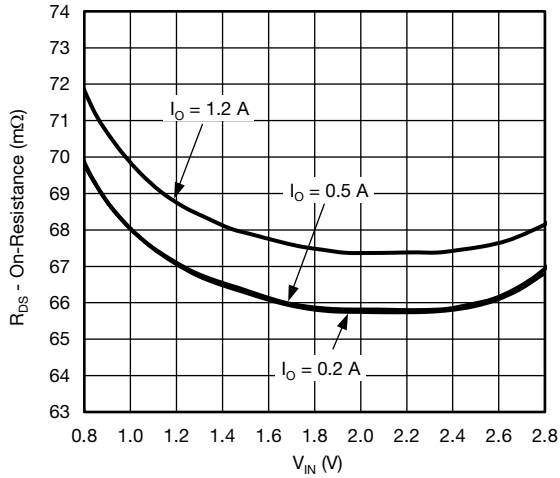

Fig. 10 -  $R_{DS(on)}$  vs.  $V_{IN}$

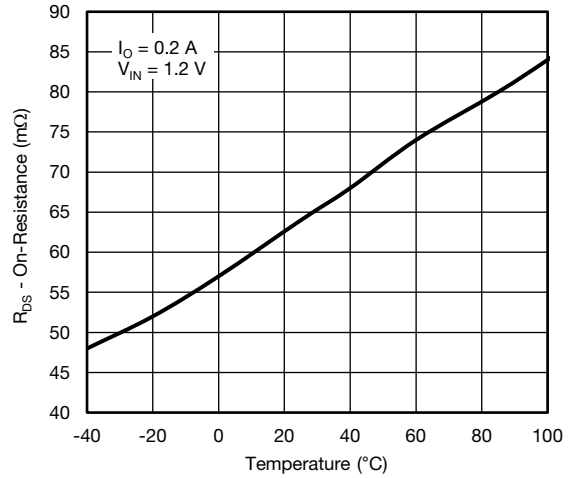

Fig. 13 -  $R_{DS(on)}$  vs. Temperature

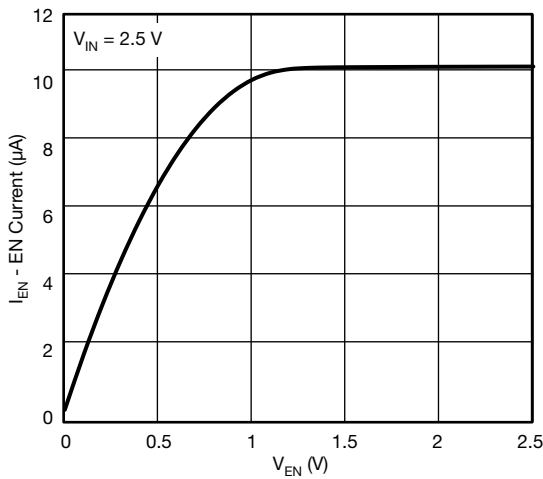

Fig. 11 -  $I_{EN}$  vs.  $V_{EN}$

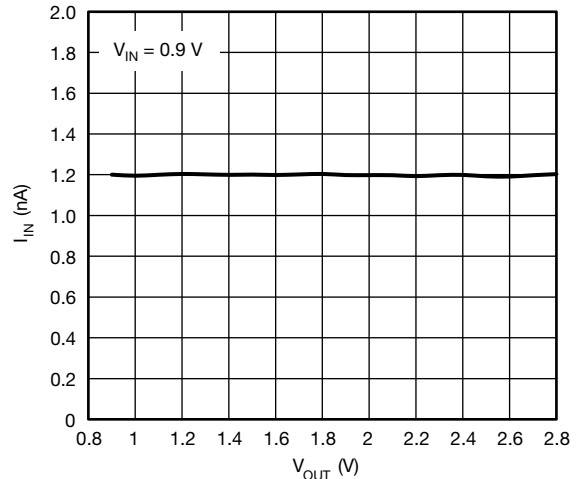

Fig. 14 - Reverse Blocking Current vs. Output Voltage

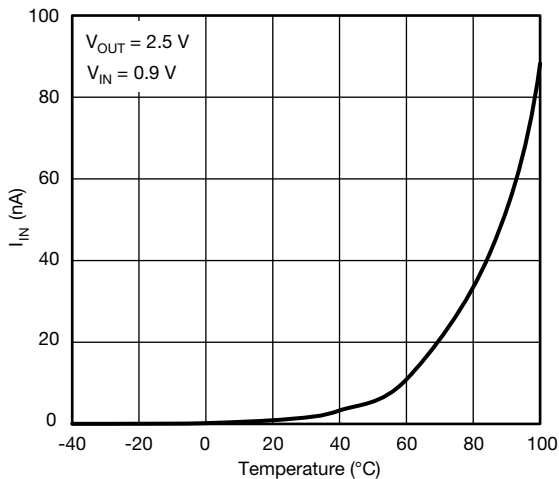

Fig. 12 - Reverse Blocking Current vs. Temperature

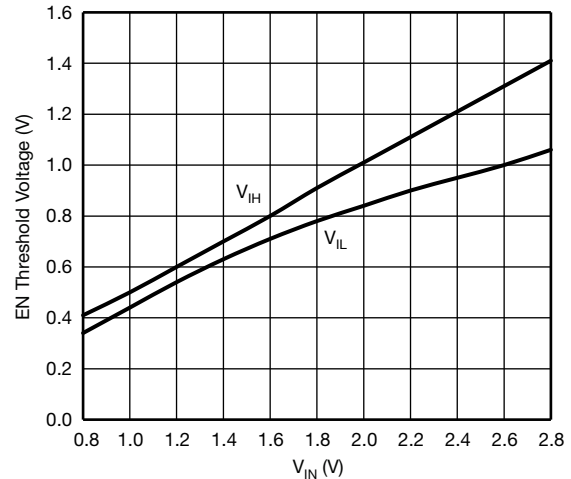

Fig. 15 - EN Threshold Voltage vs. Input Voltage

**TYPICAL CHARACTERISTICS** (internally regulated, 25 °C, unless otherwise noted)

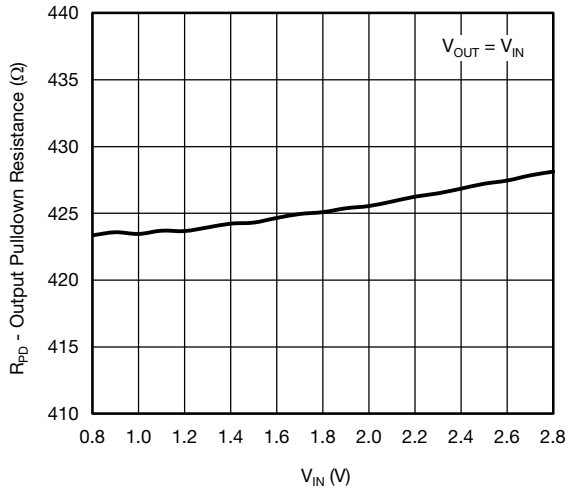

Fig. 16 - Output Pulldown Resistance vs. Input Voltage

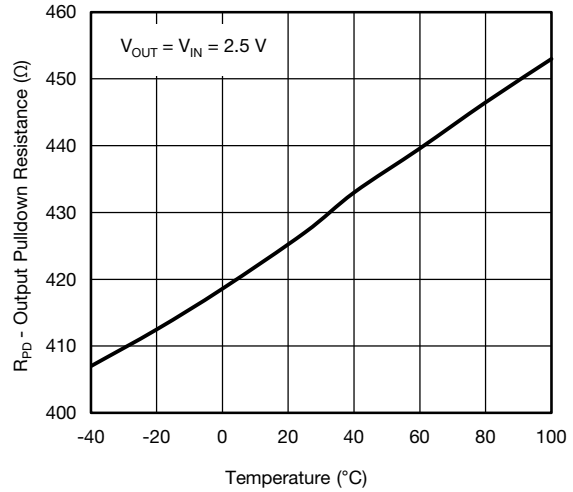

Fig. 19 - Output Pulldown Resistance vs. Temperature

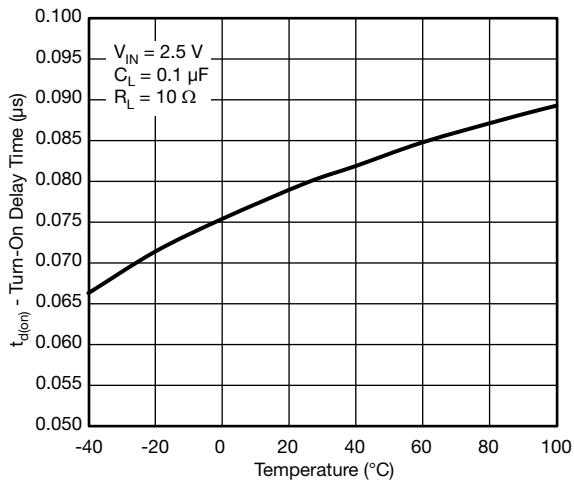

Fig. 17 - Turn-On Delay Time vs. Temperature

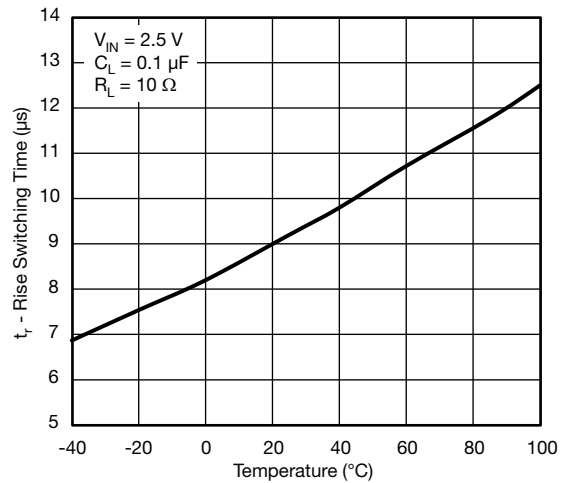

Fig. 20 - Rise Time vs. Temperature

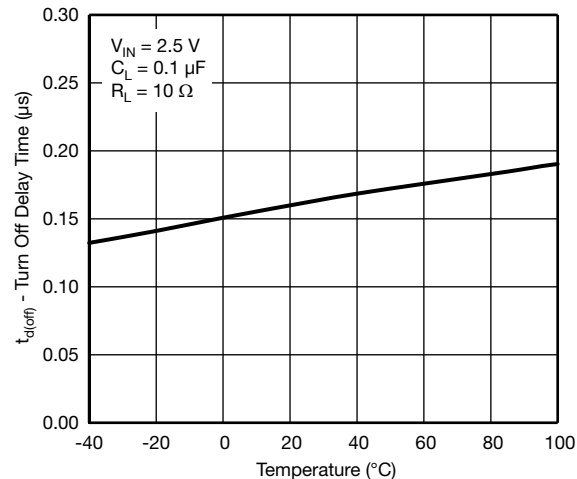
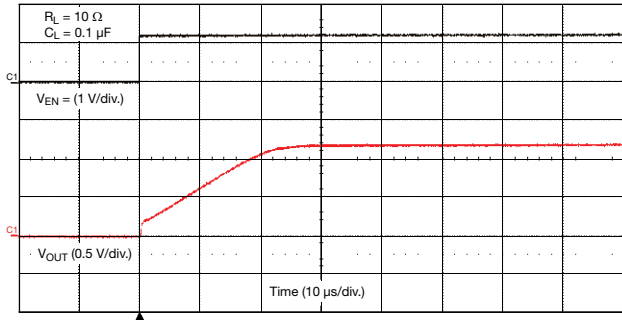
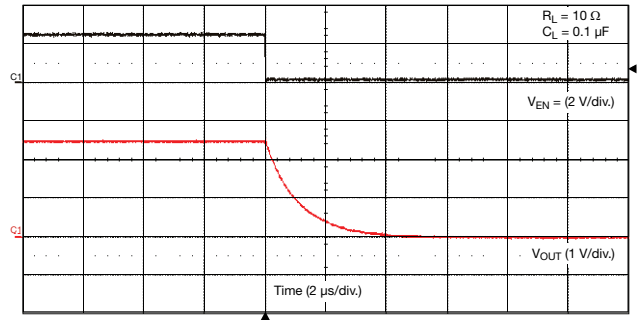

Fig. 18 - Turn-Off Delay Time vs. Temperature

**TYPICAL WAVEFORMS**



**Fig. 21 - Turn-On Time ( $V_{IN} = 1.2\text{ V}$ )**



**Fig. 24 - Turn-Off Time ( $V_{IN} = 2.5\text{ V}$ )**

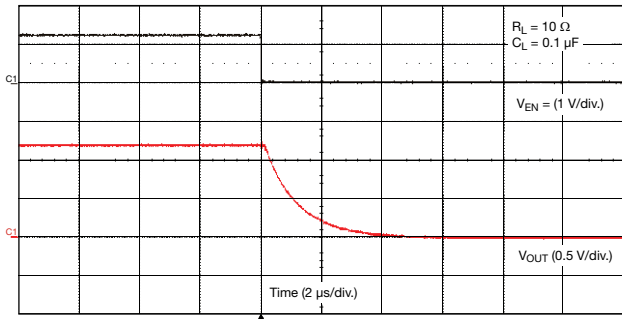

**Fig. 22 - Turn-Off Time ( $V_{IN} = 1.2\text{ V}$ )**

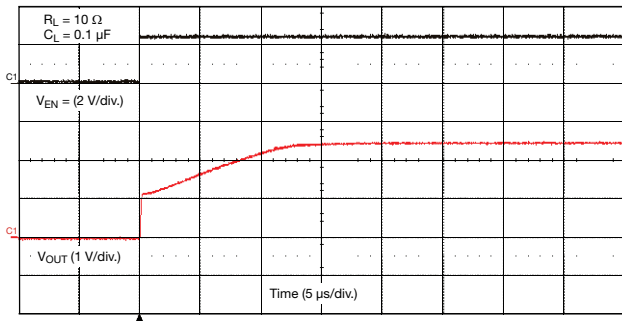

**Fig. 23 - Turn-On Time ( $V_{IN} = 2.5\text{ V}$ )**



**DETAILED DESCRIPTION**

The SiP32501 is a compact, low R<sub>ON</sub> turn on slew rate controlled load switch. The device has 66 mΩ resistance and operates over the input voltage range of 0.9 V to 2.5 V without requirement of extra bias power rail.

The SiP32501 consisted of an n-channel power MOSFET designed as high side load switch. Once enabled the device charge pumps the gate of the power MOSFET to a constant gate to source voltage for fast turn on time. The mostly constant gate to source voltage keeps the on resistance low through the input voltage range.

The SiP32501 features an output discharge circuit to help discharge the output capacitor. Because the body of the output n-channel is always connected to GND, it prevents the current from going back to the input in case the output voltage is higher than the input.

The SiP32501 has low input logic control threshold that can interface with low voltage control GPIO directly without extra level shift or driver. The switch supports designs when control logic voltage is higher than input power voltage. There is a pull down at this EN logic control pin.

The SiP32501 has 20 μs typically for input voltage of 1.2 V. Its turn off delay time is less than 1 μs. An output discharge switch is integrated.

**APPLICATION INFORMATION**

**Input Capacitor**

While a bypass capacitor on the input is not required, to minimize the voltage drop on the input supply caused by load transient, a C<sub>IN</sub> is recommended to be placed close to IN pin. A ceramic capacitor is recommended because of their ability to withstand current surges.

**Output Capacitor**

A 0.1 μF capacitor across V<sub>OUT</sub> and GND is recommended to insure proper slew operation. There is inrush current through the output MOSFET and the magnitude of the inrush current depends on the output capacitor, the bigger the C<sub>OUT</sub> the higher the inrush current. There are no ESR or capacitor type requirement.

**Enable**

The EN pin is compatible with CMOS logic voltage levels. It requires at least 0.1 V or below to fully shut down the device and 1.5 V or above to fully turn on the device. The EN pin can withstand voltage higher than V<sub>IN</sub>.

**Protection Against Reverse Voltage Condition**

SiP32501 can block the output current from going to the input in case where the output voltage is higher than the input voltage when the main switch is off.

**Thermal Considerations**

This device is designed to maintain a constant output load current. Due to physical limitations of the layout and assembly of the device the maximum switch current is 1.2 A as stated in the Absolute Maximum Ratings table. However, another limiting characteristic for the safe operating load current is the thermal power dissipation of the package and the PCB layout. To obtain the highest power dissipation (and a thermal resistance of 170 °C/W) the device should be connected to a heat sink on the printed circuit board.

The maximum power dissipation in any application is dependent on the maximum junction temperature, T<sub>J</sub> (max.) = 125 °C, the junction-to-ambient thermal resistance, θ<sub>J-A</sub> = 170 °C/W, and the ambient temperature, T<sub>A</sub>, which may be formulaically expressed as:

$$P \text{ (max.)} = \frac{T_J \text{ (max.)} - T_A}{\theta_{JA}} = \frac{125 - T_A}{170}$$

It then follows that, assuming an ambient temperature of 70 °C, the maximum power dissipation will be limited to about 323 mW.

So long as the load current is below the 1.2 A limit, the maximum continuous switch current becomes a function two things: the package power dissipation and the R<sub>DS(on)</sub> at the ambient temperature.

As an example let us calculate the worst case maximum load current at T<sub>A</sub> = 70 °C. The worst case R<sub>DS(on)</sub> at 25 °C is 82 mΩ. The R<sub>DS(on)</sub> at 70 °C can be extrapolated from this data using the following formula:

$$R_{DS(on)} \text{ (at } 70 \text{ }^\circ\text{C)} = R_{DS(on)} \text{ (at } 25 \text{ }^\circ\text{C)} \times (1 + T_C \times \Delta T)$$

Where T<sub>C</sub> is 4100 ppm/°C. Continuing with the calculation we have

$$R_{DS(on)} \text{ (at } 70 \text{ }^\circ\text{C)} = 82 \text{ m}\Omega \times (1 + 0.0041 \times (70 \text{ }^\circ\text{C} - 25 \text{ }^\circ\text{C})) = 97.1 \text{ m}\Omega$$

The maximum current limit is then determined by

$$I_{LOAD} \text{ (max.)} < \sqrt{\frac{P \text{ (max.)}}{R_{DS(on)}}}$$

which in this case is 1.82 A. Under the stated input voltage condition, if the 1.82 A current limit is exceeded the internal die temperature will rise and eventually, possibly damage the device.

To avoid possible permanent damage to the device and keep a reasonable design margin, it is recommended to operate the device maximum up to 1.2 A only as listed in the Absolute Maximum Ratings table.





PRODUCT SUMMARY	
Part number	SiP32501
Description	0.9 V to 2.5 V, 66 mΩ, 9.8 μs rise time, load switch
Configuration	Single
Slew rate time (μs)	9.8
On delay time (μs)	0.05
Input voltage min. (V)	0.9
Input voltage max. (V)	2.5
On-resistance at input voltage min. (mΩ)	69
On-resistance at input voltage max. (mΩ)	66
Quiescent current at input voltage min. (μA)	5
Quiescent current at input voltage max. (μA)	40
Output discharge (yes / no)	No
Reverse blocking (yes / no)	Yes
Continuous current (A)	1.2
Package type	TDFN4
Package size (W, L, H) (mm)	1.2 x 1.6 x 0.5
Status code	2
Product type	Slew rate
Applications	Computers, consumer, industrial, healthcare, networking, portable

Vishay Siliconix maintains worldwide manufacturing capability. Products may be manufactured at one of several qualified locations. Reliability data for Silicon Technology and Package Reliability represent a composite of all qualified locations. For related documents such as package/tape drawings, part marking, and reliability data, see [www.vishay.com/ppg?75595](http://www.vishay.com/ppg?75595).



TDFN4 1.2 x 1.6 Case Outline

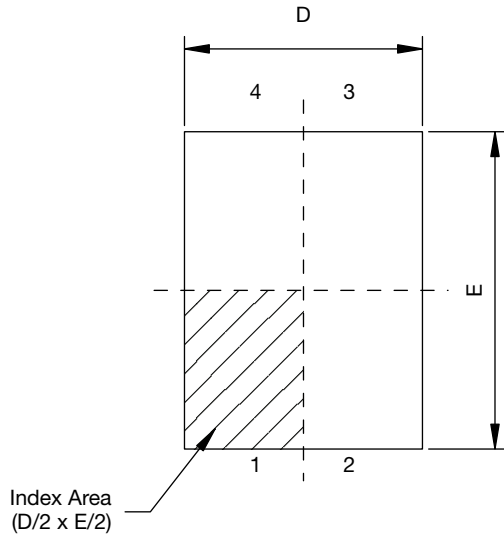

Top View

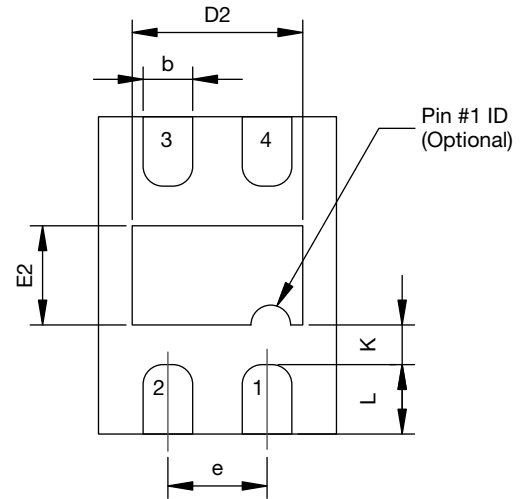

Bottom View

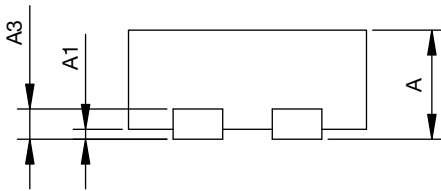

Side View

DIM.	MILLIMETERS			INCHES		
	MIN.	NOM.	MAX.	MIN.	NOM.	MAX.
A	0.45	0.55	0.60	0.017	0.022	0.024
A1	0.00	-	0.05	0.00	-	0.002
A3	0.15 REF. or 0.127 REF. <sup>(1)</sup>			0.006 or 0.005 <sup>(1)</sup>		
b	0.20	0.25	0.30	0.008	0.010	0.012
D	1.15	1.20	1.25	0.045	0.047	0.049
D2	0.81	0.86	0.91	0.032	0.034	0.036
e	0.50 BSC			0.020		
E	1.55	1.60	1.65	0.061	0.063	0.065
E2	0.45	0.50	0.55	0.018	0.020	0.022
K	0.25 typ.			0.010 typ.		
L	0.25	0.30	0.35	0.010	0.012	0.014

ECN: T16-0143-Rev. C, 18-Apr-16  
DWG: 5995

Note

<sup>(1)</sup> The dimension depends on the leadframe that assembly house used.



## Disclaimer

ALL PRODUCT, PRODUCT SPECIFICATIONS AND DATA ARE SUBJECT TO CHANGE WITHOUT NOTICE TO IMPROVE RELIABILITY, FUNCTION OR DESIGN OR OTHERWISE.

Vishay Intertechnology, Inc., its affiliates, agents, and employees, and all persons acting on its or their behalf (collectively, "Vishay"), disclaim any and all liability for any errors, inaccuracies or incompleteness contained in any datasheet or in any other disclosure relating to any product.

Vishay makes no warranty, representation or guarantee regarding the suitability of the products for any particular purpose or the continuing production of any product. To the maximum extent permitted by applicable law, Vishay disclaims (i) any and all liability arising out of the application or use of any product, (ii) any and all liability, including without limitation special, consequential or incidental damages, and (iii) any and all implied warranties, including warranties of fitness for particular purpose, non-infringement and merchantability.

Statements regarding the suitability of products for certain types of applications are based on Vishay's knowledge of typical requirements that are often placed on Vishay products in generic applications. Such statements are not binding statements about the suitability of products for a particular application. It is the customer's responsibility to validate that a particular product with the properties described in the product specification is suitable for use in a particular application. Parameters provided in datasheets and / or specifications may vary in different applications and performance may vary over time. All operating parameters, including typical parameters, must be validated for each customer application by the customer's technical experts. Product specifications do not expand or otherwise modify Vishay's terms and conditions of purchase, including but not limited to the warranty expressed therein.

Hyperlinks included in this datasheet may direct users to third-party websites. These links are provided as a convenience and for informational purposes only. Inclusion of these hyperlinks does not constitute an endorsement or an approval by Vishay of any of the products, services or opinions of the corporation, organization or individual associated with the third-party website. Vishay disclaims any and all liability and bears no responsibility for the accuracy, legality or content of the third-party website or for that of subsequent links.

Except as expressly indicated in writing, Vishay products are not designed for use in medical, life-saving, or life-sustaining applications or for any other application in which the failure of the Vishay product could result in personal injury or death. Customers using or selling Vishay products not expressly indicated for use in such applications do so at their own risk. Please contact authorized Vishay personnel to obtain written terms and conditions regarding products designed for such applications.

No license, express or implied, by estoppel or otherwise, to any intellectual property rights is granted by this document or by any conduct of Vishay. Product names and markings noted herein may be trademarks of their respective owners.