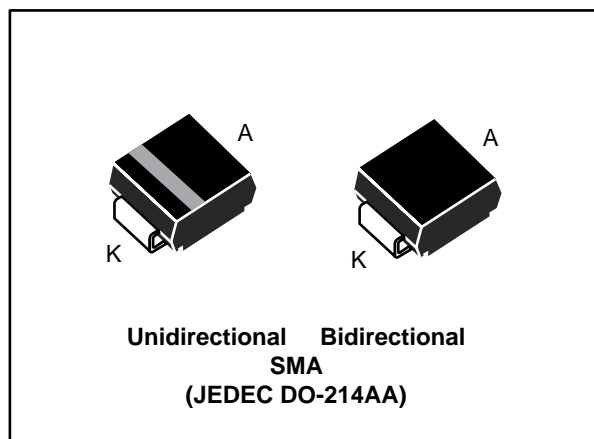

**High junction temperature Transil™**

Datasheet - production data

**Description**

The SMA6J Transil series has been designed to protect sensitive equipment against electro-static discharges according to IEC 61000-4-2, MIL STD 883 Method 3015, and electrical overstress such as IEC 61000-4-4 and 5. They are generally for surges below 600 W 10/1000  $\mu$ s.

This planar technology makes it compatible with high-end equipment and SMPS where low leakage current and high junction temperature are required to provide reliability and stability over time. Their low clamping voltages provides a better safety margin to protect sensitive circuits with extended life time expectancy.

Packaged in SMA, this minimizes PCB space consumption (SMA footprint in accordance with IPC 7531 standard).

Transil™ is a trademark of STMicroelectronics

**Features**

- Peak pulse power:
  - 600 W (10/1000  $\mu$ s)
  - 4 kW (8/20  $\mu$ s)
- Stand-off voltage range: from 5 V to 188 V
- Unidirectional and bidirectional types
- Low leakage current:
  - 0.2  $\mu$ A at 25 °C
  - 1  $\mu$ A at 85 °C
- Operating  $T_j$  max: 175 °C
- JEDEC registered package outline

**Complies with the following standards**

- IEC 61000-4-2 level 4:
  - 15 kV (air discharge)
  - 8 kV (contact discharge)
- MIL STD 883G, method 3015-7: class 3B:
  - 25 kV HBM (human body model)

# 1 Characteristics

Table 1: Absolute maximum ratings ( $T_{amb} = 25\text{ }^{\circ}\text{C}$ )

Symbol	Parameter		Value	Unit
$P_{PP}$	Peak pulse power dissipation	$T_j \text{ initial} = T_{amb}$	600	W
$P$	Power dissipation on infinite heatsink	$T_{amb} = 55\text{ }^{\circ}\text{C}$	4	W
$T_{stg}$	Storage temperature range		-65 to +175	$^{\circ}\text{C}$
$T_j$	Operating junction temperature range		-55 to +175	$^{\circ}\text{C}$
$T_L$	Maximum lead temperature for soldering during 10 s		260	$^{\circ}\text{C}$

Table 2: Thermal resistance

Symbol	Parameter	Value	Unit
$R_{th(j-l)}$	Junction to leads	30	$^{\circ}\text{C}/\text{W}$
$R_{th(j-a)}$	Junction to ambient on printed circuit on recommended pad layout	120	$^{\circ}\text{C}/\text{W}$

Figure 1: Electrical characteristics - parameter definitions

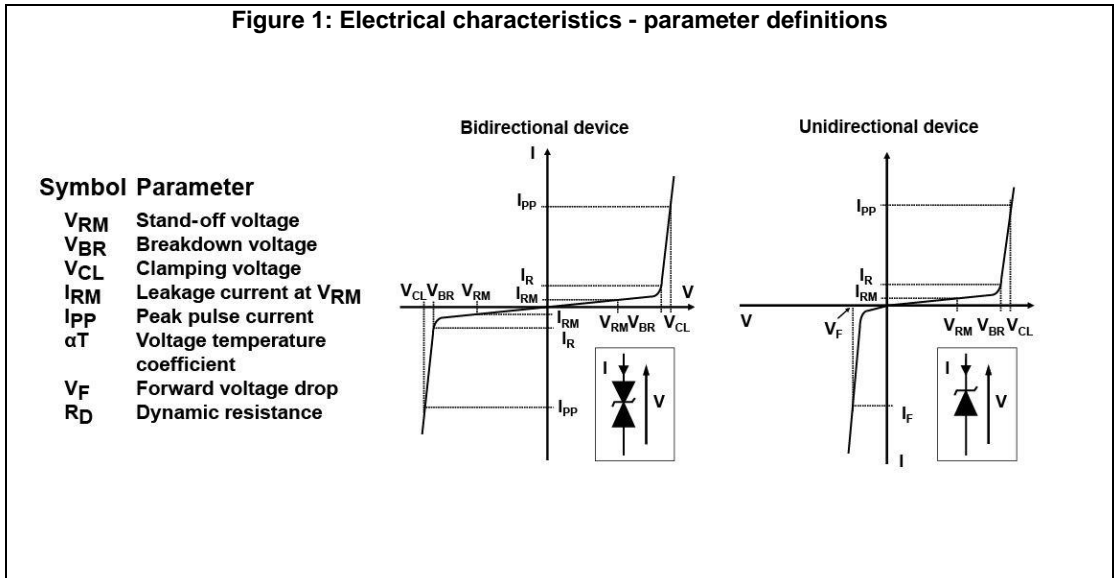

Figure 2: Pulse definition for electrical characteristics

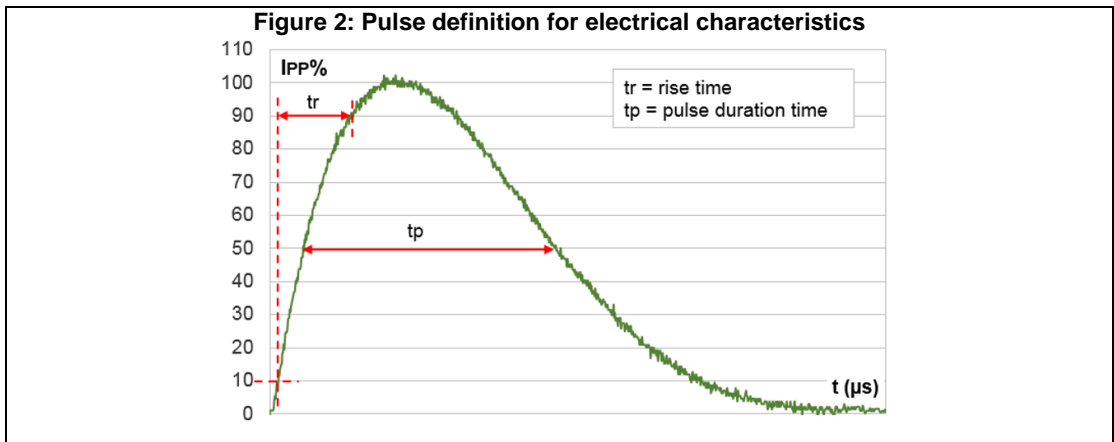

Table 3: Electrical characteristics parameter values ( $T_{amb} = 25\text{ °C}$ , unless otherwise specified)

Order code	$I_{RM}$ max at $V_{RM}$			$V_{BR}$ at $I_R^{(1)}$				10 / 1000 $\mu$ s			8 / 20 $\mu$ s			$\alpha T^{(2)}$
	25 °C	85 °C		Min.	Typ.	Max.		$V_{CL}$	$I_{PP}$	$R_D$	$V_{CL}$	$I_{PP}$	$R_D$	Max.
								Max.		Max.	Max.			
	$\mu$ A	V	V		mA	V <sup>(3)</sup>	A <sup>(4)</sup>	$\Omega$	V	A	$\Omega$	10 <sup>-4</sup> /°C		
SMA6J5.A/CA	20	50	5.0	6.40	6.74	7.07	10	9.1	68	0.029	14.4	275	0.027	5.7
SMA6J6.0A/CA	20	50	6.0	6.70	7.05	7.41	10	9.5	61	0.034	14.8	270	0.027	5.9
SMA6J6.5A/CA	20	50	6.5	7.20	7.58	7.96	10	10.2	56	0.040	15.2	266	0.027	6.1
SMA6J8.5A/CA	20	50	8.5	9.4	9.9	10.4	1	13.3	41.7	0.070	19.5	205	0.044	7.3
SMA6J10A/CA	0.2	1	10	11.1	11.7	12.3	1	15.7	37	0.093	21.7	184	0.051	7.8
SMA6J12A/CA	0.2	1	12	13.3	14.0	14.7	1	18.8	31	0.133	25.3	157	0.068	8.3
SMA6J13A/CA	0.2	1	13	14.4	15.2	15.9	1	20.4	29	0.154	27.2	147	0.076	8.4
SMA6J15A/CA	0.2	1	15	16.7	17.6	18.5	1	23.6	25.1	0.206	32.5	123	0.114	8.8
SMA6J18A/CA	0.2	1	18	20.0	21.1	22.1	1	28.3	21.5	0.288	39.3	102	0.168	9.2
SMA6J20A/CA	0.2	1	20	22.2	23.4	24.5	1	31.4	19.4	0.354	42.8	93	0.196	9.4
SMA6J24A/CA	0.2	1	24	26.7	28.1	29.5	1	37.8	16	0.516	50	80	0.256	9.6
SMA6J26A/CA	0.2	1	26	28.9	30.4	31.9	1	40.9	14.9	0.600	53.5	75	0.288	9.7
SMA6J28A/CA	0.2	1	28	31.1	32.7	34.4	1	44.0	13.8	0.697	59	68	0.363	9.8
SMA6J33A/CA	0.2	1	33	36.7	38.6	40.6	1	51.9	11.8	0.963	69	57	0.512	10.0
SMA6J40A/CA	0.2	1	40	44.4	46.7	49.1	1	62.8	9.7	1.42	84	48	0.728	10.1
SMA6J48A/CA	0.2	1	48	53.3	56.1	58.9	1	75.4	8.1	2.04	100	40	1.03	10.3
SMA6J58A/CA	0.2	1	58	64.4	67.8	71.2	1	91.1	6.7	2.97	121	33	1.51	10.4
SMA6J70A/CA	0.2	1	70	77.8	81.9	86.0	1	110	5.5	4.38	146	27	2.22	10.5
SMA6J85A/CA	0.2	1	85	94	99	104	1	134	4.6	6.45	178	22.5	3.29	10.6
SMA6J100A/CA	0.2	1	100	111	117	123	1	157	3.8	9.03	212	19	4.69	10.7
SMA6J130A/CA	0.2	1	130	144	152	159	1	204	3	14.9	265	15	7.03	10.8
SMA6J154A/CA	0.2	1	154	171	180	189	1	242	2.4	22.1	317	12.6	10.2	10.8
SMA6J170A/CA	0.2	1	170	189	199	209	1	275	2.2	30.0	353	11.3	12.7	10.8
SMA6J188A/CA	0.2	1	188	209	220	231	1	328	2	48.5	388	10.3	15.2	10.8

**Notes:**<sup>(1)</sup>Pulse test:  $t_p < 50$  ms<sup>(2)</sup>To calculate  $V_{BR}$  or  $V_{CL}$  versus junction temperature, use the following formulas:

- $V_{BR}$  at  $T_J = V_{BR}$  at  $25\text{ °C} \times (1 + \alpha T \times (T_J - 25))$   
 $V_{CL}$  at  $T_J = V_{CL}$  at  $25\text{ °C} \times (1 + \alpha T \times (T_J - 25))$

<sup>(3)</sup>To calculate maximum clamping voltage at other surge level, use the following formula:

- $V_{CLmax} = V_{BRmax} + R_D \times I_{PPappli}$  where  $I_{PPappli}$  is the surge current in the application

<sup>(4)</sup>Surge capability given for both directions for unidirectional and bidirectional types.

### 1.1 Characteristics (curves)

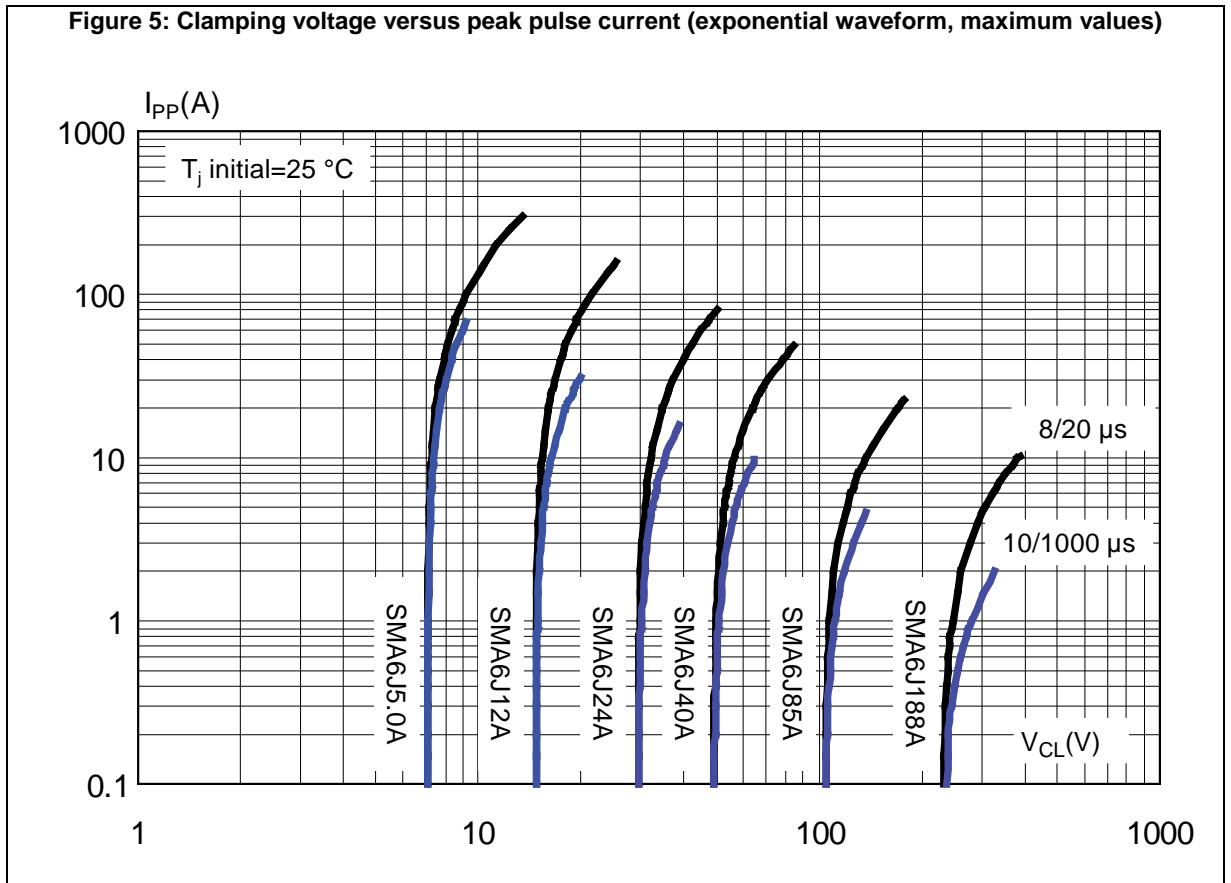
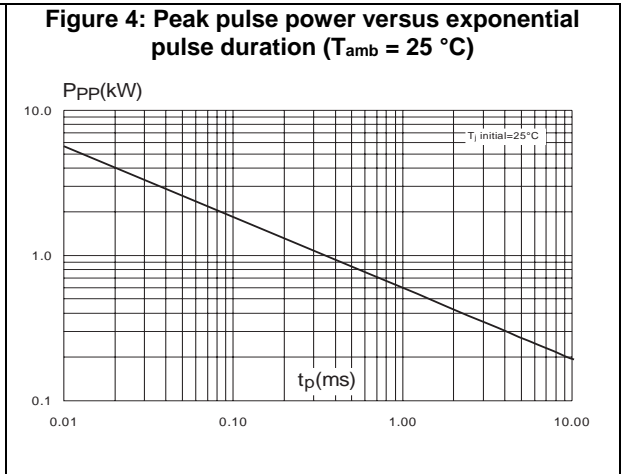
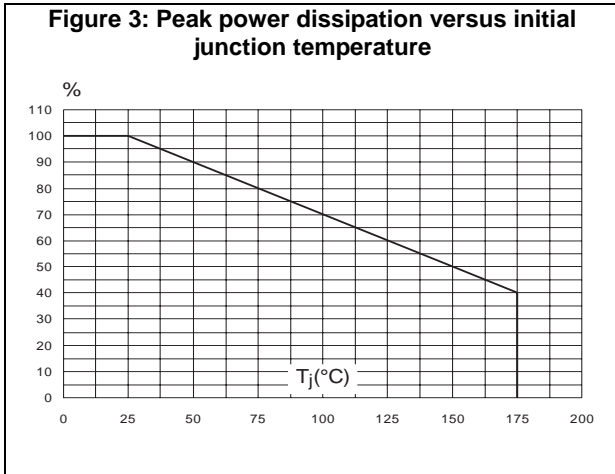

**Figure 6: Junction capacitance versus reverse applied voltage (typical values) (SMA6JxxA)**

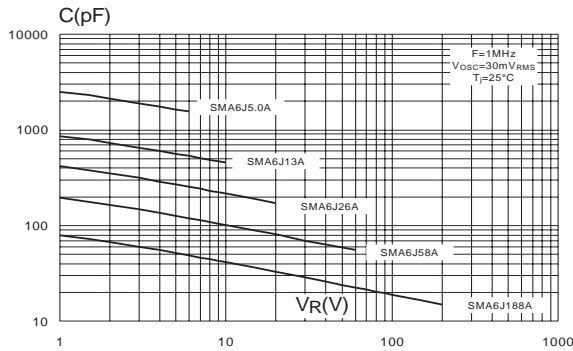

**Figure 7: Junction capacitance versus reverse applied voltage (typical values) (SMA6JxxCA)**

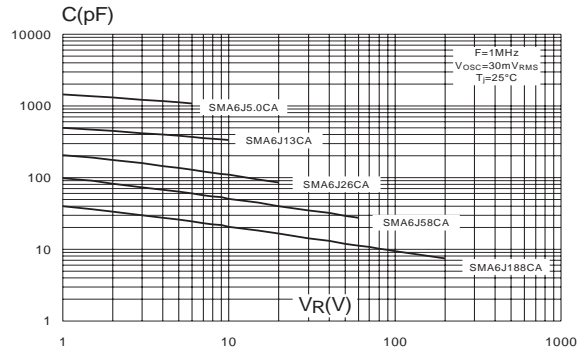

**Figure 8: Peak forward voltage drop versus peak forward current (typical values)**

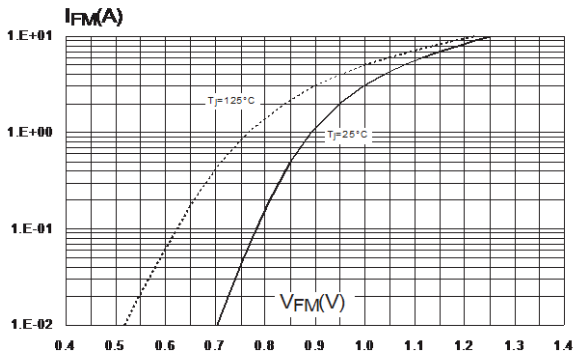

**Figure 9: Relative variation of thermal impedance junction to ambient versus pulse duration (printed circuit board FR4, SCu = 1 cm<sup>2</sup>)**

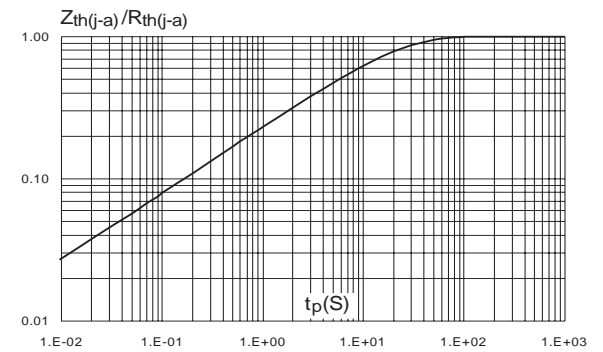

**Figure 10: Thermal resistance junction to ambient versus copper surface under each lead (printed circuit board FR4, eCu = 35 μm)**

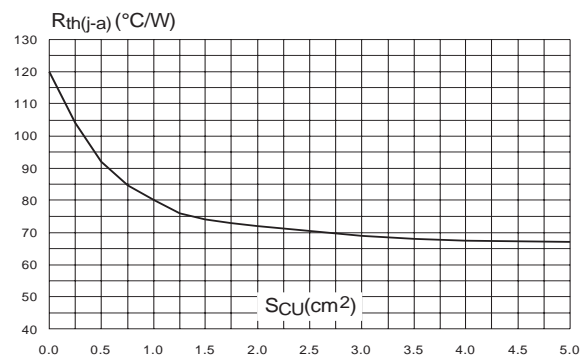

**Figure 11: Leakage current versus junction temperature (typical values)**

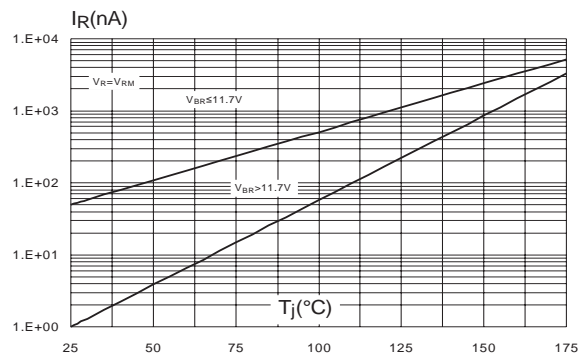

## 2 Package information

In order to meet environmental requirements, ST offers these devices in different grades of ECOPACK® packages, depending on their level of environmental compliance. ECOPACK® specifications, grade definitions and product status are available at: [www.st.com](http://www.st.com). ECOPACK® is an ST trademark.

- Case: JEDEC DO214-AA molded plastic over planar junction
- Terminals: solder plated, solderable per MIL-STD-750, method 2026
- Polarity: for unidirectional types the band indicates cathode
- Flammability: epoxy is rated UL94V-0
- RoHS package

### 2.1 SMB package information

Figure 12: SMA package outline

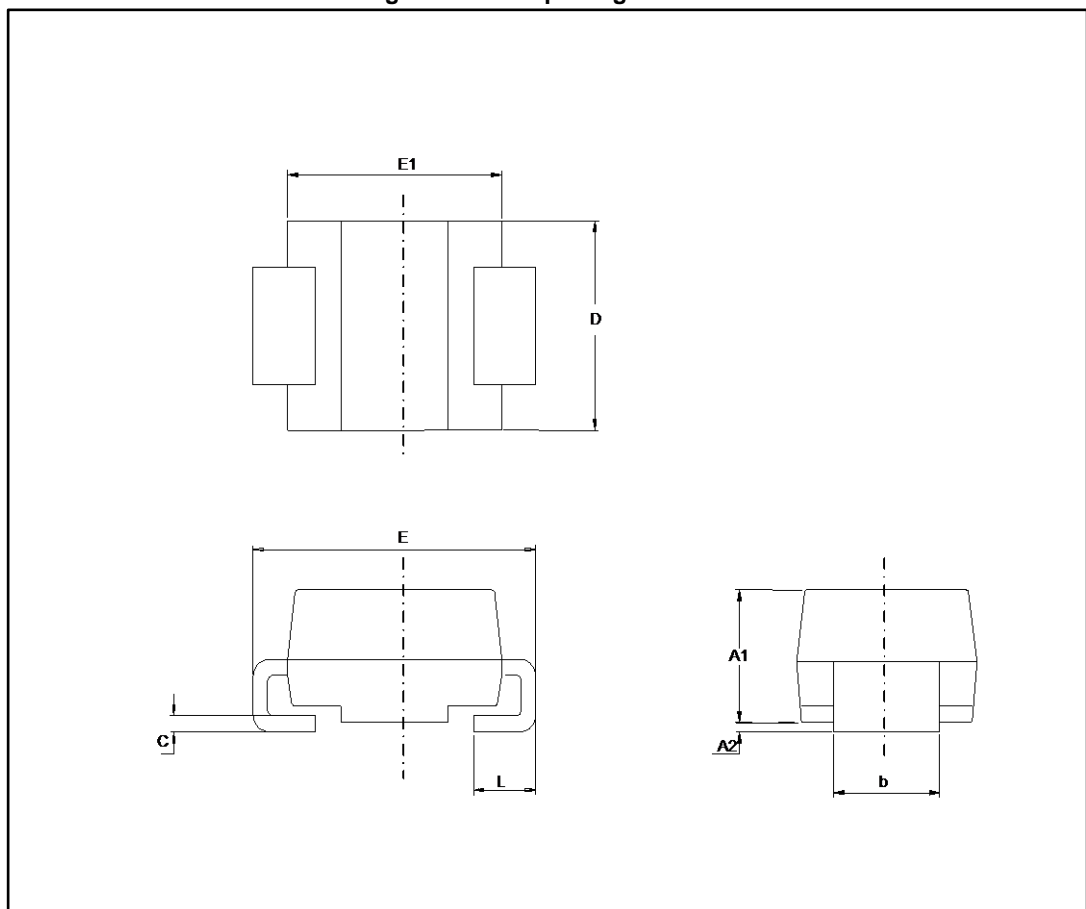
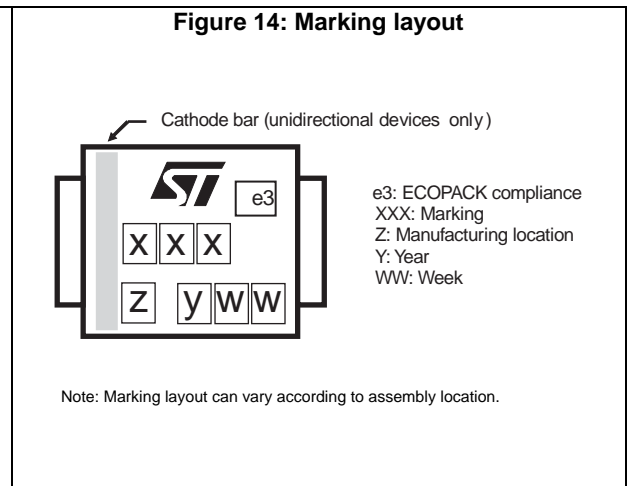
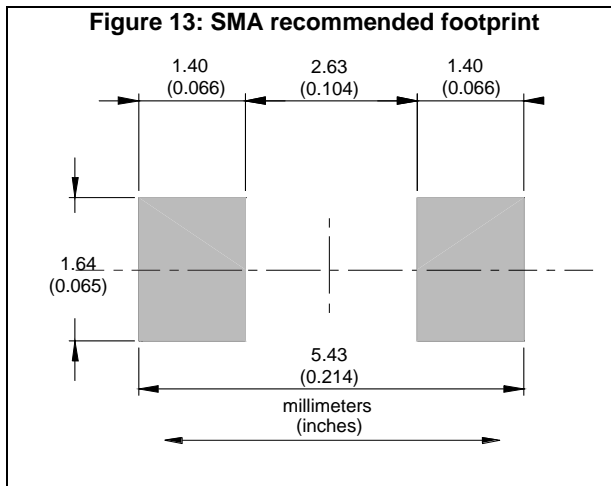

Table 4: SMA package mechanical data

Ref.	Dimensions			
	Millimeters		Inches	
	Min.	Max.	Min.	Max.
A1	1.90	2.45	0.0748	0.0964
A2	0.05	0.20	0.0020	0.0079
b	1.25	1.65	0.0492	0.0649
c	0.15	0.40	0.0059	0.0157
D	2.25	2.90	0.0885	0.1141
E	4.80	5.35	0.1889	0.2106
E1	3.95	4.60	0.1555	0.1811
L	0.75	1.50	0.0295	0.0591



### 3 Ordering information

Figure 15: Ordering information scheme

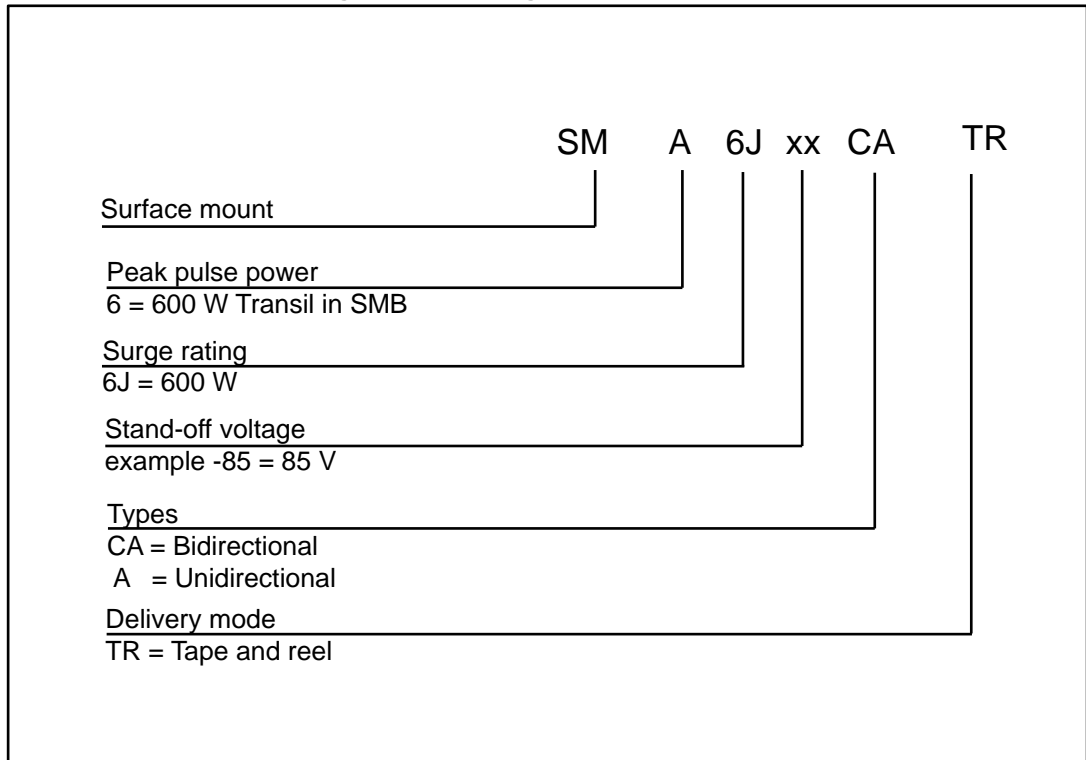

Table 5: Ordering information

Order code <sup>(1)</sup>	Marking	Package	Weight	Base qty.	Delivery mode
SMA6JxxA-TR	See <a href="#">Table 6: "Marking"</a> .	SMA	0.072 g	5000	Tape and reel
SMA6JxxCA-TR					

**Notes:**

<sup>(1)</sup>xx indicates stand-off voltage



Table 6: Marking

Order code	Marking	Order code	Marking
SMA6J5.0A	6UA	SMA6J5.0CA	6BA
SMA6J6.0A	6UB	SMA6J6.0CA	6BB
SMA6J6.5A	6UC	SMA6J6.5CA	6BC
SMA6J8.5A	6UD	SMA6J8.5CA	6BD
SMA6J10A	6UE	SMA6J10CA	6UE
SMA6J12A	6UF	SMA6J12CA	6UF
SMA6J13A	6UG	SMA6J13CA	6UG
SMA6J15A	6UH	SMA6J15CA	6UH
SMA6J18A	6UJ	SMA6J18CA	6UJ
SMA6J20A	6UK	SMA6J20CA	6UK
SMA6J24A	6UM	SMA6J24CA	6UM
SMA6J26A	6UN	SMA6J26CA	6UN
SMA6J28A	6UO	SMA6J28CA	6UO
SMA6J33A	6UQ	SMA6J33CA	6UQ
SMA6J40A	6UR	SMA6J40CA	6UR
SMA6J48A	6US	SMA6J48CA	6US
SMA6J58A	6UT	SMA6J58CA	6UT
SMA6J70A	6UU	SMA6J70CA	6BU
SMA6J85A	6UV	SMA6J85CA	6BV
SMA6J100A	6UW	SMA6J100CA	6BW
SMA6J130A	6UX	SMA6J130A	6BX
SMA6J154A	6UY	SMA6J154A	6BY
SMA6J170A	6UZ	SMA6J170A	6BZ
SMA6J188A	6UAA	SMA6J188A	6BAA

## 4 Revision history

**Table 7: Document revision history**

Date	Revision	Changes
21-Feb-2007	1	First issue.
7-Nov-2007	2	Updated Description. Improved readability of Ordering information scheme. Reformatted to current standards.
04-Aug-2014	3	Updated weight in Table 7.
28-Oct-2015	4	Updated Table 4 and Figure 3.
04-Jul-2017	5	Updated Table 4.
22-Jan-2018	6	Updated <a href="#">Table 3: "Electrical characteristics parameter values (Tamb = 25 °C, unless otherwise specified)"</a> .

**IMPORTANT NOTICE – PLEASE READ CAREFULLY**

STMicroelectronics NV and its subsidiaries ("ST") reserve the right to make changes, corrections, enhancements, modifications, and improvements to ST products and/or to this document at any time without notice. Purchasers should obtain the latest relevant information on ST products before placing orders. ST products are sold pursuant to ST's terms and conditions of sale in place at the time of order acknowledgement.

Purchasers are solely responsible for the choice, selection, and use of ST products and ST assumes no liability for application assistance or the design of Purchasers' products.

No license, express or implied, to any intellectual property right is granted by ST herein.

Resale of ST products with provisions different from the information set forth herein shall void any warranty granted by ST for such product.

ST and the ST logo are trademarks of ST. All other product or service names are the property of their respective owners.

Information in this document supersedes and replaces information previously supplied in any prior versions of this document.

© 2018 STMicroelectronics – All rights reserved