

Surface Mount TRANSZORB[®] Transient Voltage Suppressors

SMC (DO-214AB)

Cathode Anode

RoHS
 COMPLIANT
 HALOGEN
FREE
FEATURES

- Unidirectional
- Peak pulse power:
 - 5000 W (10/1000 μ s)
 - 40 kW (8/20 μ s)
- Excellent clamping capability
- Very fast response time
- Low incremental surge resistance
- Meets MSL level 1, per J-STD-020, LF maximum peak of 260 °C
- AEC-Q101 qualified
 - Automotive ordering code: base P/NHM3 for SMC5K10A to SMC5K20A
- UL recognition for safety 497B with file number E136766
- Material categorization: for definitions of compliance please see www.vishay.com/doc?99912

LINKS TO ADDITIONAL RESOURCES

PRIMARY CHARACTERISTICS	
V_{BR}	11.1 V to 104 V
V_{WM}	10 V to 85 V
P_{PPM}	5000 W
T_J max.	150 °C
Polarity	Unidirectional
Package	SMC (DO-214AB)

TYPICAL APPLICATIONS

Use in sensitive electronics protection against voltage transients induced by inductive load switching and lighting on ICs, MOSFET, signal lines of sensor units for consumer, computer, industrial, automotive, and telecommunication.

MECHANICAL DATA

Case: SMC (DO-214AB)
 Molding compound meets UL 94 V-0 flammability rating
 Base P/N-M3 - halogen-free, RoHS-compliant
 Base P/NHM3_X - halogen-free, RoHS-compliant, and AEC-Q101 qualified
 (“_X” denotes revision code e.g. A, B, ... and only available for SMC5K10A to 20A types)

Terminals: matte tin plated leads, solderable per J-STD-002 and JESD 22-B102
 M3 suffix meets JESD 201 class 2 whisker test, HM3 suffix meets JESD 201 class 2 whisker test

Note

- SMC5K22A to SMC5K85A for industrial grade only

Polarity: color band denotes cathode end

MAXIMUM RATINGS ($T_A = 25$ °C unless otherwise noted)			
PARAMETER	SYMBOL	VALUE	UNIT
Peak pulse power dissipation with a 10/1000 μ s waveform (fig. 1)	$P_{PPM}^{(1)}$	5000	W
Peak pulse current with a 10/1000 μ s waveform (fig 3.)	$I_{PPM}^{(1)}$	See next table	A
Operating junction and storage temperature range	T_J, T_{STG}	-55 to +150	°C

Note

⁽¹⁾ Non-repetitive current pulse, per fig. 3 and derated above $T_A = 25$ °C, per fig. 2



ELECTRICAL CHARACTERISTICS (T _A = 25 °C unless otherwise noted)										
DEVICE TYPE	DEVICE MARKING CODE	BREAKDOWN VOLTAGE V _{BR} AT I _T ⁽¹⁾ (V)		TEST CURRENT I _T (mA)	STAND-OFF VOLTAGE V _{WM} (V)	MAXIMUM REVERSE LEAKAGE AT V _{WM} D (μA)	MAXIMUM CLAMPING VOLTAGE V _C AT I _{PPM} 10/1000 μs		MAXIMUM CLAMPING VOLTAGE V _C AT I _{PPM} 8/20 μs	
		MIN.	MAX.				(V)	(A)	(V)	(A)
SMC5K10A	5GDY	11.1	12.3	1.0	10	10.0	17.0	294	24.1	1660
SMC5K12A	5GEE	13.3	14.7	1.0	12	5.0	19.9	251	25.3	1581
SMC5K13A	5GEG	14.4	15.9	1.0	13	2.0	21.5	233	27.2	1471
SMC5K14A	5GEK	15.6	17.2	1.0	14	2.0	23.2	216	30.0	1333
SMC5K15A	5GEM	16.7	18.5	1.0	15	2.0	24.4	205	32.5	1231
SMC5K16A	5GEP	17.8	19.7	1.0	16	2.0	26.0	192	34.4	1163
SMC5K17A	5GER	18.9	20.9	1.0	17	2.0	27.6	181	37.0	1081
SMC5K18A	5GET	20.0	22.1	1.0	18	2.0	29.2	171	39.3	1018
SMC5K20A	5GEV	22.2	24.5	1.0	20	2.0	32.4	154	42.8	935
SMC5K22A	5GEX	24.4	26.9	1.0	22	1.0	35.5	141	48.2	830
SMC5K24A	5GEZ	26.7	29.5	1.0	24	1.0	38.9	129	51.6	775
SMC5K26A	5GFE	28.9	31.9	1.0	26	1.0	42.1	119	55.8	717
SMC5K28A	5GFG	31.1	34.4	1.0	28	1.0	45.4	110	60.2	664
SMC5K30A	5GFK	33.3	36.8	1.0	30	1.0	48.4	103	64.0	625
SMC5K33A	5GFM	36.7	40.6	1.0	33	1.0	53.3	93.8	69.8	573
SMC5K36A	5GFP	40.0	44.2	1.0	36	1.0	58.1	86.1	76.0	526
SMC5K40A	5GFR	44.4	49.1	1.0	40	1.0	64.5	77.5	84.0	476
SMC5K43A	5GFT	47.8	52.8	1.0	43	1.0	69.4	72.0	90.3	443
SMC5K45A	5GFV	50.0	55.3	1.0	45	1.0	72.7	68.8	94.6	423
SMC5K48A	5GFX	53.3	58.9	1.0	48	1.0	77.4	64.6	100	400
SMC5K51A	5GFZ	56.7	62.7	1.0	51	1.0	82.4	60.7	107	374
SMC5K54A	5GGE	60.0	66.3	1.0	54	1.0	87.1	57.4	113	354
SMC5K58A	5GGG	64.4	71.2	1.0	58	1.0	93.6	53.4	121	331
SMC5K60A	5GGK	66.7	73.7	1.0	60	1.0	96.8	51.7	125	320
SMC5K64A	5GGM	71.1	78.6	1.0	64	1.0	103	48.5	134	299
SMC5K70A	5GGP	77.8	86.0	1.0	70	1.0	113	44.2	146	274
SMC5K75A	5GGR	83.3	92.1	1.0	75	1.0	121	41.3	157	255
SMC5K78A	5GGT	86.7	95.8	1.0	78	1.0	126	39.7	163	245
SMC5K85A	5GGV	94.4	104	1.0	85	1.0	137	36.5	177	226

Notes

- (1) Pulse test: t_p ≤ 50 ms
- (2) Surge current waveform per fig. 3 and derated per fig.2
- (3) All terms and symbols are consistent with ANSI/IEEE C62.35

THERMAL CHARACTERISTICS (T _A = 25 °C unless otherwise noted)			
PARAMETER	SYMBOL	TYP.	UNIT
Thermal resistance	R _{thJA} ⁽¹⁾	90	°C/W
	R _{thJM} ⁽²⁾	4.0	°C/W

Notes

- (1) Thermal resistance junction-to-ambient to follow JEDEC® 51-2A, device mounted on FR4 PCB, 2 oz. standard footprint
- (2) Thermal resistance junction-to-mount to follow JEDEC® 51-14 using Transient Dual Interface Test Method (TDIM)

IMMUNITY TO STATIC ELECTRICAL DISCHARGE TO THE FOLLOWING STANDARDS (T _A = 25 °C unless otherwise noted)				
STANDARD	TEST TYPE	TEST CONDITIONS	SYMBOL	VALUE
IEC 61000-4-2	Human body model (contact mode)	C = 150 pF, R = 330 Ω	ESD	30 kV
	Human body model (air discharge mode)			30 kV



ORDERING INFORMATION (Example)				
PREFERRED P/N	UNIT WEIGHT (g)	PREFERRED PACKAGE CODE	BASE QUANTITY	DELIVERY MODE
SMC5K10A-M3/H ⁽¹⁾	0.257	H	850	7" diameter plastic tape and reel
SMC5K10A-M3/I ⁽¹⁾	0.257	I	3500	13" diameter plastic tape and reel
SMC5K10AHM3_A/H ⁽²⁾	0.257	H	850	7" diameter plastic tape and reel
SMC5K10AHM3_A/I ⁽²⁾	0.257	I	3500	13" diameter plastic tape and reel

Notes

- ⁽¹⁾ Available for SMC5K10A to SMC5K85A
- ⁽²⁾ AEC-Q101 qualified, available for SMC5K10A to SMC5K20A only

RATINGS AND CHARACTERISTICS CURVES ($T_A = 25\text{ }^\circ\text{C}$ unless otherwise noted)

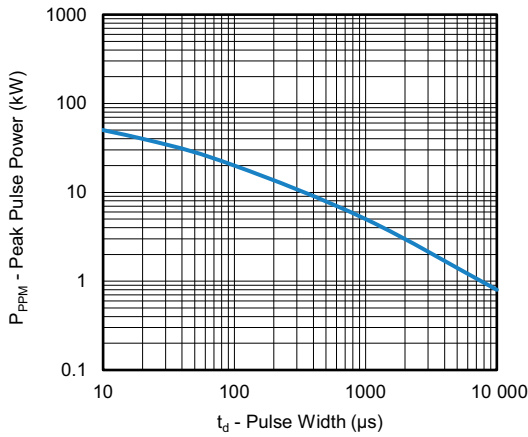

Fig. 1 - Peak Pulse Power Derating Curve

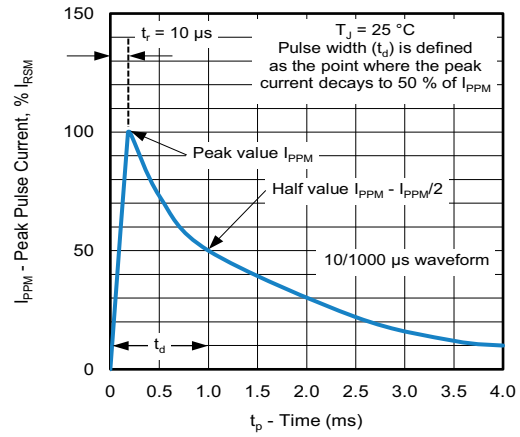

Fig. 3 - Pulse Waveform

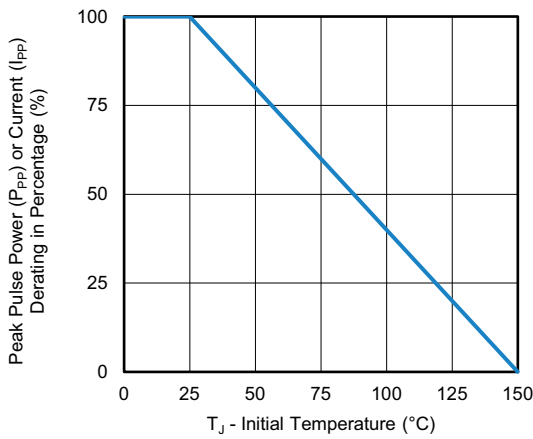

Fig. 2 - Peak Pulse Power or Current vs. Initial Junction Temperature

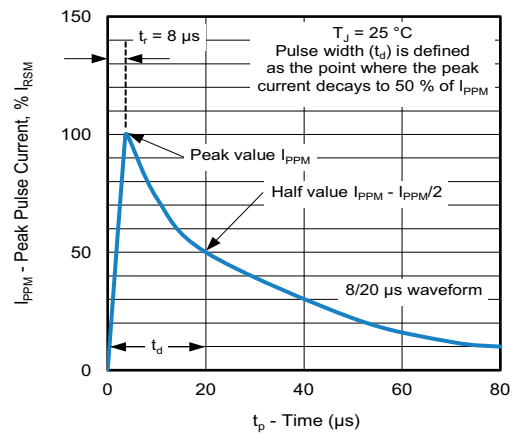

Fig. 4 - Pulse Waveform

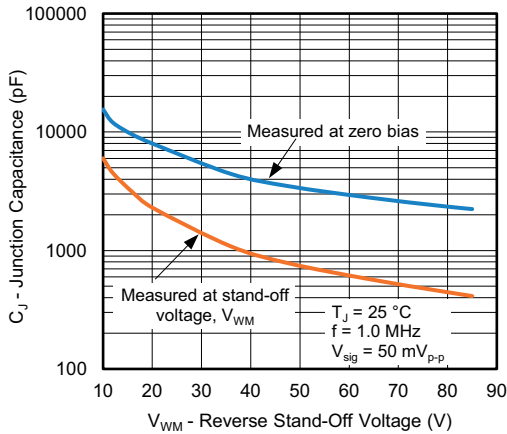

Fig. 5 - Typical Junction Capacitance

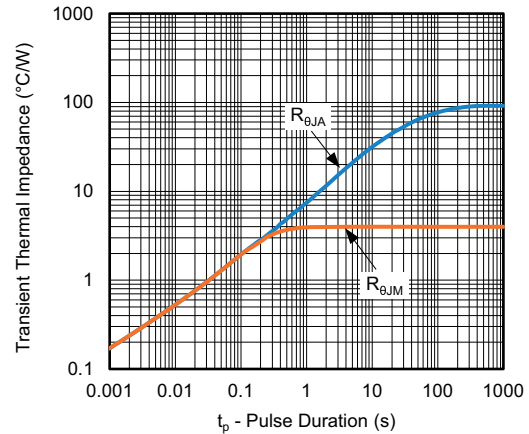
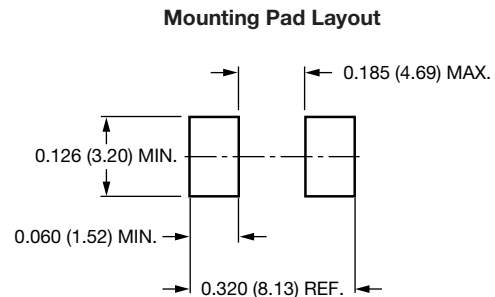
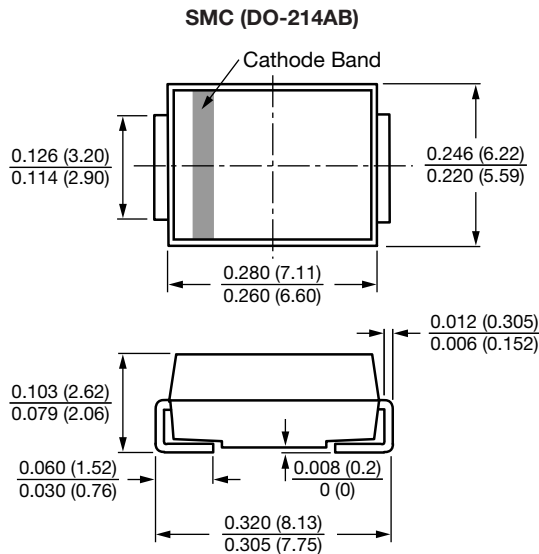

Fig. 6 - Typical Transient thermal Impedance

Notes

- Fig.1 - Power calculations is based on I_{PPM} times defined maximum clamping voltage by pulse width
- Fig.1 - 10 000 μs P_{PPM} is actual test for $V_{WM} \leq 60 V$ types, over 60 V types 10 000 μs P_{PPM} is curve extensional value

PACKAGE OUTLINE DIMENSIONS in inches (millimeters)





Disclaimer

ALL PRODUCT, PRODUCT SPECIFICATIONS AND DATA ARE SUBJECT TO CHANGE WITHOUT NOTICE TO IMPROVE RELIABILITY, FUNCTION OR DESIGN OR OTHERWISE.

Vishay Intertechnology, Inc., its affiliates, agents, and employees, and all persons acting on its or their behalf (collectively, "Vishay"), disclaim any and all liability for any errors, inaccuracies or incompleteness contained in any datasheet or in any other disclosure relating to any product.

Vishay makes no warranty, representation or guarantee regarding the suitability of the products for any particular purpose or the continuing production of any product. To the maximum extent permitted by applicable law, Vishay disclaims (i) any and all liability arising out of the application or use of any product, (ii) any and all liability, including without limitation special, consequential or incidental damages, and (iii) any and all implied warranties, including warranties of fitness for particular purpose, non-infringement and merchantability.

Statements regarding the suitability of products for certain types of applications are based on Vishay's knowledge of typical requirements that are often placed on Vishay products in generic applications. Such statements are not binding statements about the suitability of products for a particular application. It is the customer's responsibility to validate that a particular product with the properties described in the product specification is suitable for use in a particular application. Parameters provided in datasheets and / or specifications may vary in different applications and performance may vary over time. All operating parameters, including typical parameters, must be validated for each customer application by the customer's technical experts. Product specifications do not expand or otherwise modify Vishay's terms and conditions of purchase, including but not limited to the warranty expressed therein.

Hyperlinks included in this datasheet may direct users to third-party websites. These links are provided as a convenience and for informational purposes only. Inclusion of these hyperlinks does not constitute an endorsement or an approval by Vishay of any of the products, services or opinions of the corporation, organization or individual associated with the third-party website. Vishay disclaims any and all liability and bears no responsibility for the accuracy, legality or content of the third-party website or for that of subsequent links.

Except as expressly indicated in writing, Vishay products are not designed for use in medical, life-saving, or life-sustaining applications or for any other application in which the failure of the Vishay product could result in personal injury or death. Customers using or selling Vishay products not expressly indicated for use in such applications do so at their own risk. Please contact authorized Vishay personnel to obtain written terms and conditions regarding products designed for such applications.

No license, express or implied, by estoppel or otherwise, to any intellectual property rights is granted by this document or by any conduct of Vishay. Product names and markings noted herein may be trademarks of their respective owners.