

# SN75C188 QUADRUPLE LOW-POWER LINE DRIVERS

SLLS033F – JANUARY 1988 – REVISED MARCH 1997

- **Bi-MOS Technology With TTL and CMOS Compatibility**
- **Meets or Exceeds the Requirements of ANSI EIA/TIA-232-E and ITU Recommendation V.28**
- **Very Low Quiescent Current . . . 95  $\mu$ A Typ**  
 **$V_{CC\pm} = \pm 12$  V**
- **Current-Limited Outputs . . . 10 mA Typ**
- **CMOS-and TTL-Compatible Inputs**
- **On-Chip Slew Rate Limited to 30 V/ $\mu$ s max**
- **Flexible Supply Voltage Range**
- **Characterized at  $V_{CC\pm}$  of  $\pm 4.5$  V and  $\pm 15$  V**
- **Functionally Interchangeable With Texas Instruments SN75188, Motorola MC1488, and National Semiconductor DS14C88**

**D, DB†, OR N PACKAGE  
(TOP VIEW)**

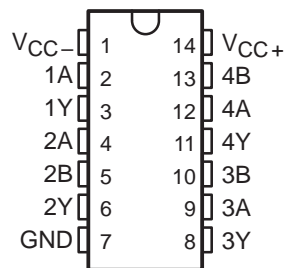

† The DB package is only available left-end taped and reeled, i.e., order device SN75C188DBLE.

## description

The SN75C188 is a monolithic, low-power, quadruple line driver that interfaces data terminal equipment with data communications equipment. This device is designed to conform to ANSI Standard EIA/TIA-232-E.

An external diode in series with each supply-voltage terminal is needed to protect the SN75C188 under certain fault conditions to comply with EIA/TIA-232-E.

The SN75C188 is characterized for operation from 0°C to 70°C.

## Function Tables

**DRIVER 1**

B	Y
H	L
L	H

**DRIVERS 2 – 4**

A	B	Y
H	H	L
L	X	H
X	L	H

H = high level, L = low level,  
X = don't care



Please be aware that an important notice concerning availability, standard warranty, and use in critical applications of Texas Instruments semiconductor products and disclaimers thereto appears at the end of this data sheet.

PRODUCTION DATA information is current as of publication date. Products conform to specifications per the terms of Texas Instruments standard warranty. Production processing does not necessarily include testing of all parameters.

**TEXAS  
INSTRUMENTS**

POST OFFICE BOX 655303 • DALLAS, TEXAS 75265

Copyright © 1997, Texas Instruments Incorporated

# SN75C188 QUADRUPLE LOW-POWER LINE DRIVERS

SLLS033F – JANUARY 1988 – REVISED MARCH 1997

## logic symbol†

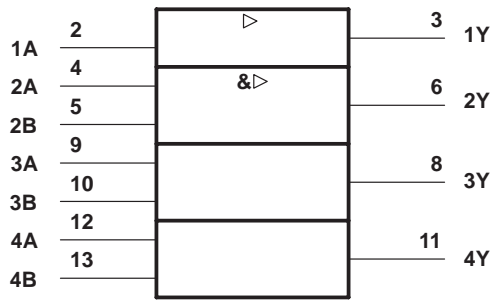

† This symbol is in accordance with ANSI/IEEE Std 91-1984 and IEC Publication 617-12.

## logic diagram (positive logic)

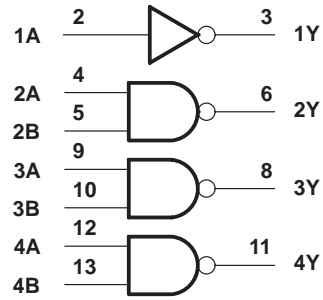

positive logic  
 $Y = \bar{A}$  (driver 1)  
 $Y = \bar{A}\bar{B}$  or  $\bar{A} + \bar{B}$  (drivers 2 through 4)

## schematics of inputs and outputs

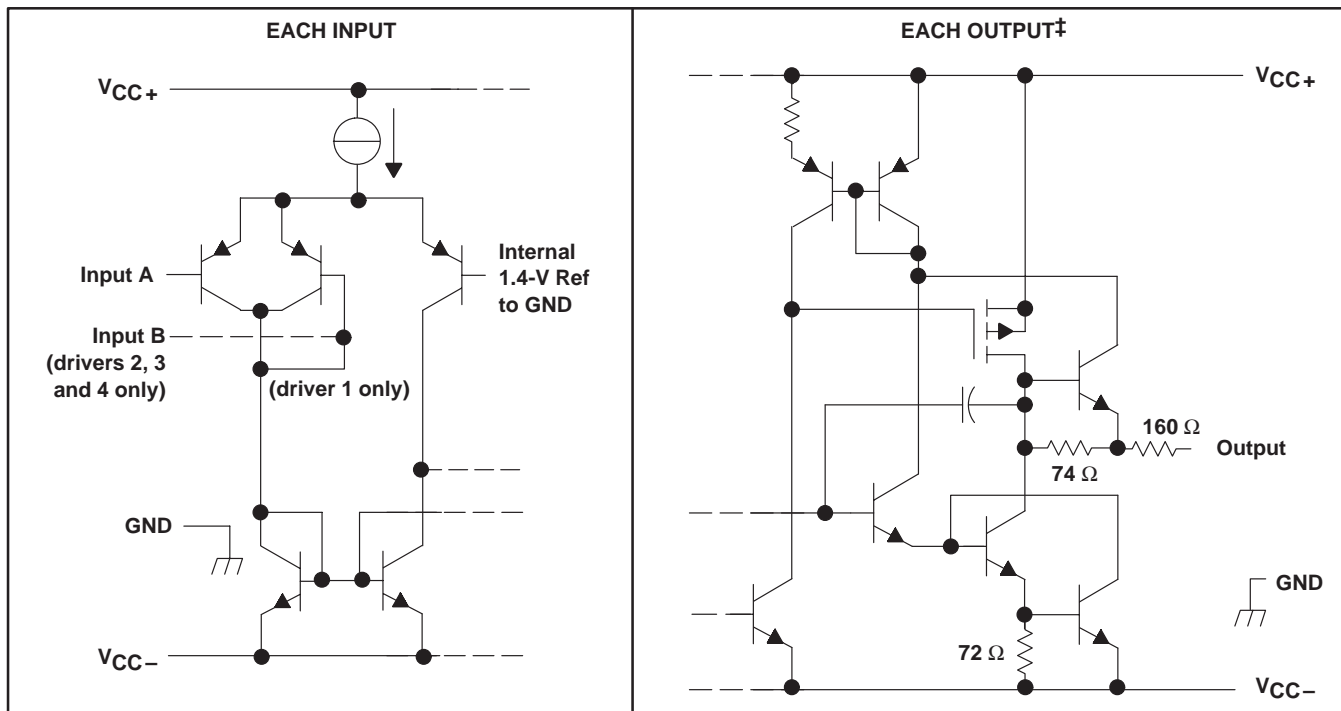

‡ All resistor values shown are nominal.

# SN75C188 QUADRUPLE LOW-POWER LINE DRIVERS

SLLS033F – JANUARY 1988 – REVISED MARCH 1997

## absolute maximum ratings over operating free-air temperature range (unless otherwise noted)†

Supply voltage, $V_{CC+}$ (see Note 1) .....	15 V
Supply voltage, $V_{CC-}$ (see Note 1) .....	-15 V
Input voltage range, $V_I$ .....	$V_{CC-}$ to $V_{CC+}$
Output voltage range, $V_O$ .....	$V_{CC-} - 6\text{ V}$ to $V_{CC+} + 6\text{ V}$
Continuous total power dissipation .....	See Dissipation Rating Table
Operating free-air temperature range, $T_A$ .....	0°C to 70°C
Storage temperature range, $T_{stg}$ .....	-65°C to 150°C
Lead temperature 1,6 mm (1/16 inch) from case for 10 seconds .....	260°C

† Stresses beyond those listed under “absolute maximum ratings” may cause permanent damage to the device. These are stress ratings only, and functional operation of the device at these or any other conditions beyond those indicated under “recommended operating conditions” is not implied. Exposure to absolute-maximum-rated conditions for extended periods may affect device reliability.

NOTE 1: All voltage values are with respect to the network ground terminal.

**DISSIPATION RATING TABLE**

PACKAGE	$T_A \leq 25^\circ\text{C}$ POWER RATING	DERATING FACTOR ABOVE $T_A = 25^\circ\text{C}$	$T_A = 70^\circ\text{C}$ POWER RATING
D	950 mW	7.6 mW/°C	608 mW
DB	525 mW	4.2 mW/°C	336 mW
N	1150 mW	9.2 mW/°C	736 mW

## recommended operating conditions

	MIN	NOM	MAX	UNIT
Supply voltage, $V_{CC+}$	4.5	12	15	V
Supply voltage, $V_{CC-}$	-4.5	-12	-15	V
Input voltage, $V_I$	$V_{CC-} + 2$		$V_{CC+}$	V
High-level Input voltage, $V_{IH}$	2			V
Low-level Input voltage, $V_{IL}$			0.8	V
Operating free-air temperature, $T_A$	0		70	°C



# SN75C188

## QUADRUPLE LOW-POWER LINE DRIVERS

SLLS033F – JANUARY 1988 – REVISED MARCH 1997

**electrical characteristics over operating free-air temperature range,  $V_{CC+} = 12\text{ V}$ ,  $V_{CC-} = -12\text{ V}$  (unless otherwise noted)**

PARAMETER		TEST CONDITIONS		MIN	TYP†	MAX	UNIT
$V_{OH}$	High-level output voltage	$V_{IL} = 0.8\text{ V}$ , $R_L = 3\text{ k}\Omega$	$V_{CC+} = 5\text{ V}$ , $V_{CC-} = -5\text{ V}$	4			V
			$V_{CC+} = 12\text{ V}$ , $V_{CC-} = -12\text{ V}$	10			
$V_{OL}$	Low-level output voltage (see Note 2)	$V_{IH} = 2\text{ V}$ , $R_L = 3\text{ k}\Omega$	$V_{CC+} = 5\text{ V}$ , $V_{CC-} = -5\text{ V}$	-4			V
			$V_{CC+} = 12\text{ V}$ , $V_{CC-} = -12\text{ V}$	-10			
$I_{IH}$	High-level input current	$V_I = 5\text{ V}$		10			$\mu\text{A}$
$I_{IL}$	Low-level input current	$V_I = 0$		-10			$\mu\text{A}$
$I_{OS(H)}$	High-level short-circuit output current‡	$V_I = 0.8\text{ V}$ , $V_O = 0$ or $V_{CC-}$	-5.5		-10	-19.5	mA
$I_{OS(L)}$	Low-level short-circuit output current‡	$V_I = 2\text{ V}$ , $V_O = 0$ or $V_{CC+}$	5.5		10	19.5	mA
$r_O$	Output resistance, power off	$V_{CC+} = 0$ , $V_{CC-} = 0$ , $V_I = -2\text{ V}$ to $2\text{ V}$	300				$\Omega$
$I_{CC+}$	Supply current from $V_{CC+}$	$V_{CC+} = 5\text{ V}$ , $V_{CC-} = -5\text{ V}$ , No load	All inputs at 2 V or 0.8 V		90	160	$\mu\text{A}$
		$V_{CC+} = 12\text{ V}$ , $V_{CC-} = -12\text{ V}$ , No load	All inputs at 2 V or 0.8 V		95	160	
$I_{CC-}$	Supply current from $V_{CC-}$	$V_{CC+} = 5\text{ V}$ , $V_{CC-} = -5\text{ V}$ , No load	All inputs at 2 V or 0.8 V		-90	-160	$\mu\text{A}$
		$V_{CC+} = 12\text{ V}$ , $V_{CC-} = -12\text{ V}$ , No load	All inputs at 2 V or 0.8 V		-95	-160	

† All typical values are at  $T_A = 25^\circ\text{C}$ .

‡ Not more than one output should be shorted at a time.

NOTE 2: The algebraic convention, in which the more positive (less negative) limit is designated as maximum, is used in this data sheet for logic levels only; e.g., if  $-4\text{ V}$  is a maximum, the typical value is a more negative voltage.

**switching characteristics,  $V_{CC+} = 12\text{ V}$ ,  $V_{CC-} = -12\text{ V}$ ,  $T_A = 25^\circ\text{C}$**

PARAMETER		TEST CONDITIONS		MIN	TYP	MAX	UNIT
$t_{PLH}$	Propagation delay time, low- to high-level output§	$R_L = 3\text{ k}\Omega$ , See Figure 1	$C_L = 15\text{ pF}$	3			$\mu\text{s}$
$t_{PHL}$	Propagation delay time, high- to low-level output§			3.5			$\mu\text{s}$
$t_{TLH}$	Transition time, low- to high-level output¶			0.53		3.2	$\mu\text{s}$
$t_{THL}$	Transition time, high- to low-level output¶			0.53		3.2	$\mu\text{s}$
$t_{TLH}^{\#}$	Transition time, low- to high-level output#	$R_L = 3\text{ k}\Omega$ to $7\text{ k}\Omega$ , See Figure 1	$C_L = 2500\text{ pF}$	1.5			$\mu\text{s}$
$t_{THL}^{\#}$	Transition time, high- to low-level output#			1.5			$\mu\text{s}$
SR	Output slew rate§	$R_L = 3\text{ k}\Omega$ to $7\text{ k}\Omega$ , $C_L = 15\text{ pF}$	6		15	30	$\text{V}/\mu\text{s}$

§ Measured at the 50% level

¶ Measured between the 10% and 90% points on the output waveform

# Measured between the 3-V and  $-3\text{ V}$  points on the output waveform (EIA/TIA-232-E conditions), all unused inputs tied either high or low



PARAMETER MEASUREMENT INFORMATION

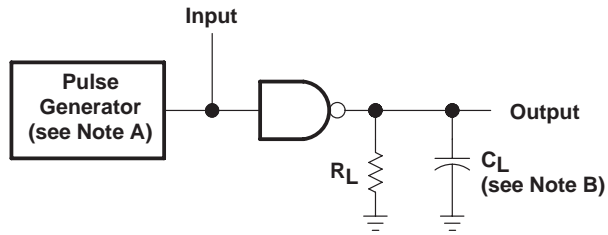

TEST CIRCUIT

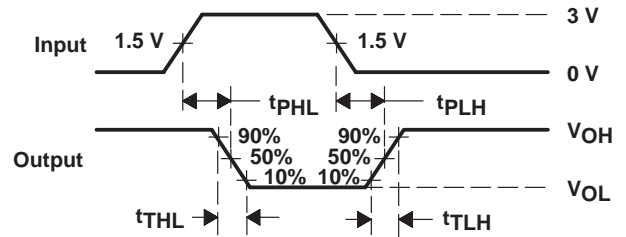

VOLTAGE WAVEFORMS

NOTES: A. The pulse generator has the following characteristics:  $t_w = 25 \mu s$ , PRR = 20 kHz,  $Z_O = 50 \Omega$ ,  $t_r = t_f \leq 50 ns$ .  
 B.  $C_L$  includes probe and jig capacitance.

Figure 1. Test Circuit and Voltage Waveforms

# SN75C188 QUADRUPLE LOW-POWER LINE DRIVERS

SLLS033F – JANUARY 1988 – REVISED MARCH 1997

## TYPICAL CHARACTERISTICS

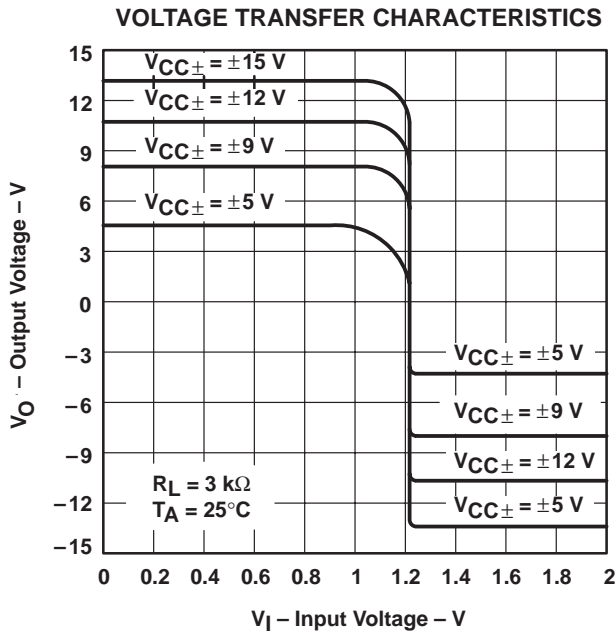

Figure 2

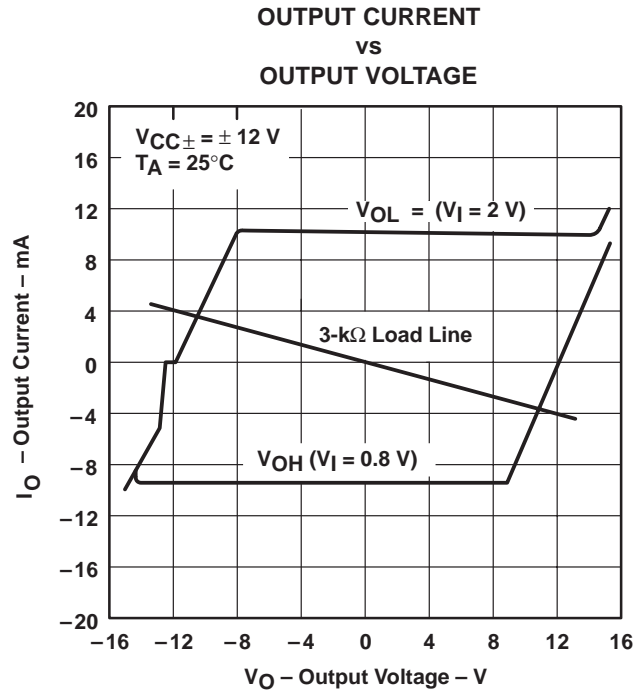

Figure 3

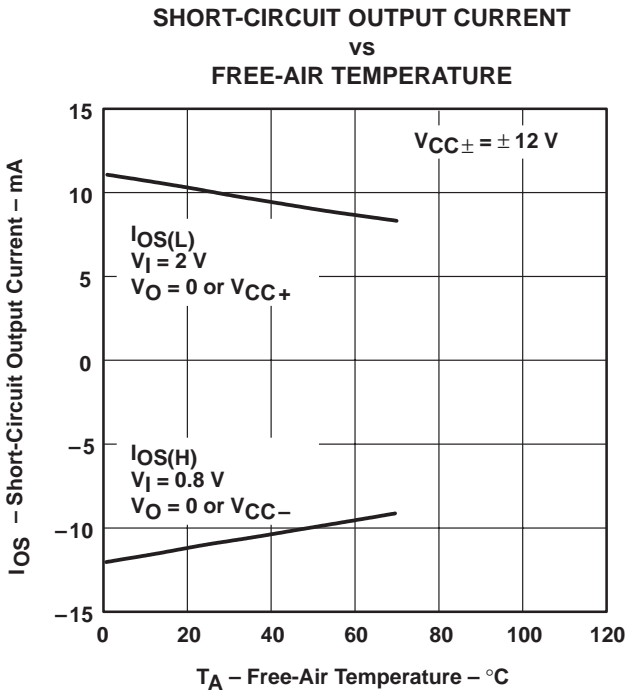

Figure 4

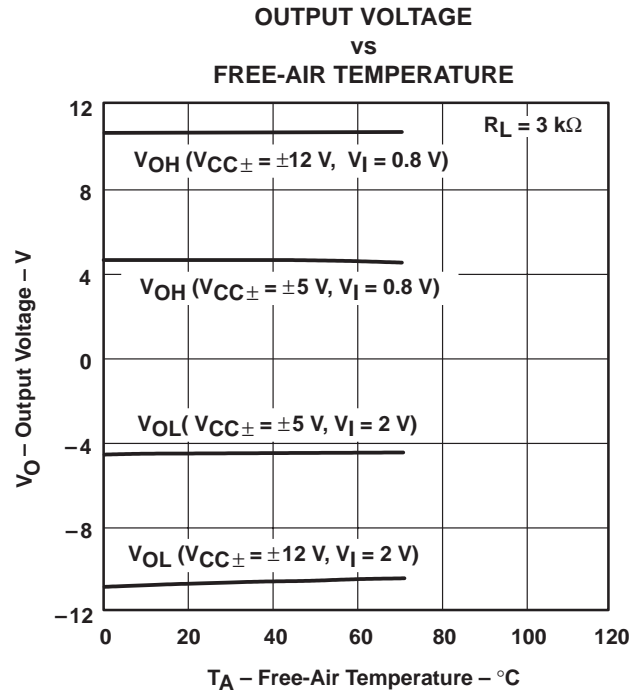

Figure 5



TYPICAL CHARACTERISTICS

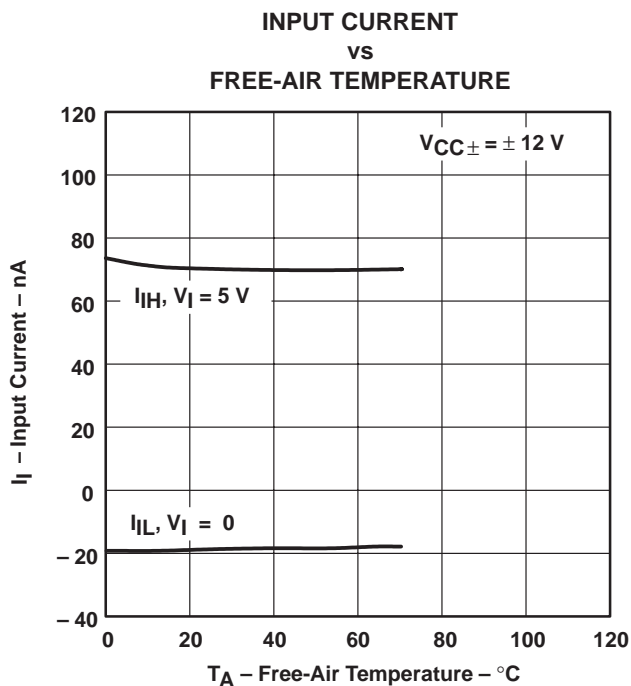

Figure 6

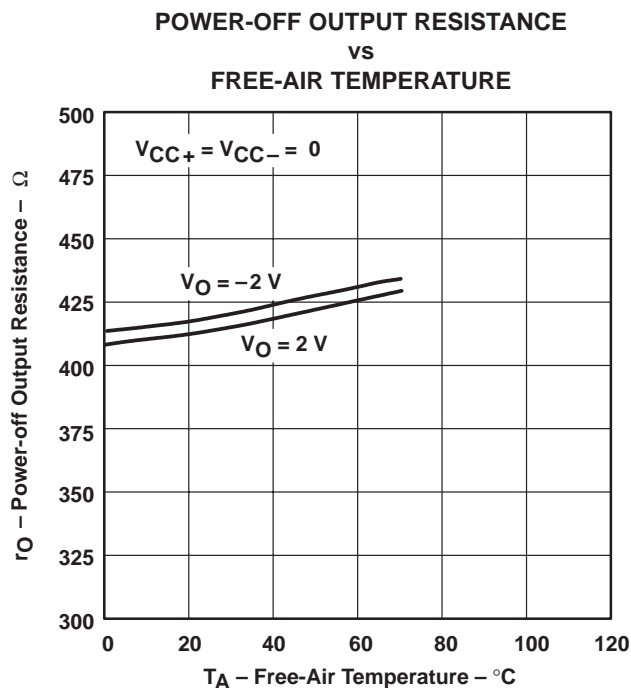

Figure 7

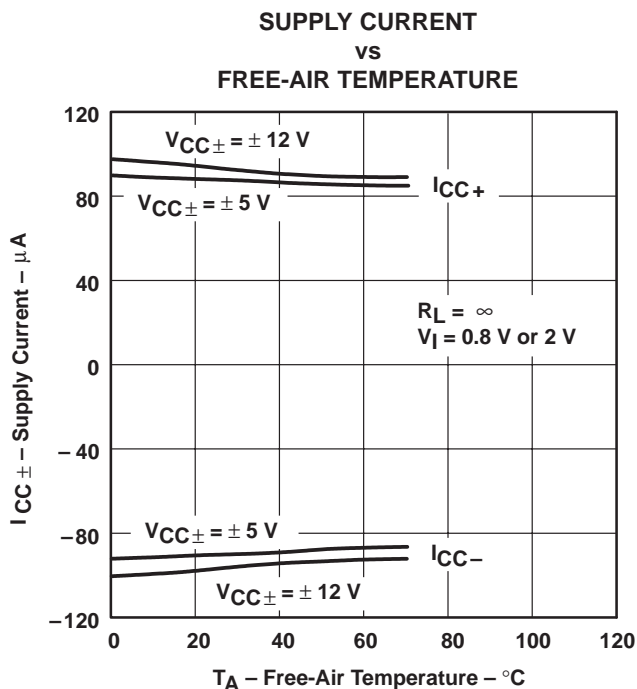

Figure 8

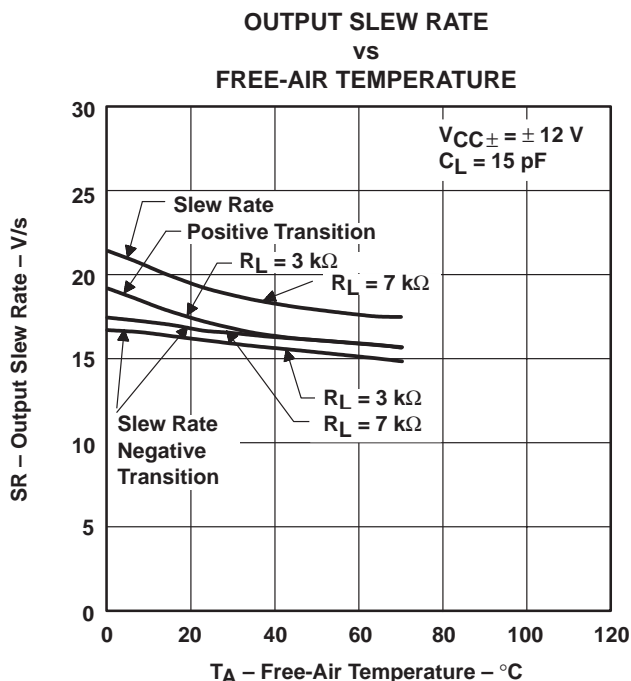

Figure 9

TYPICAL CHARACTERISTICS

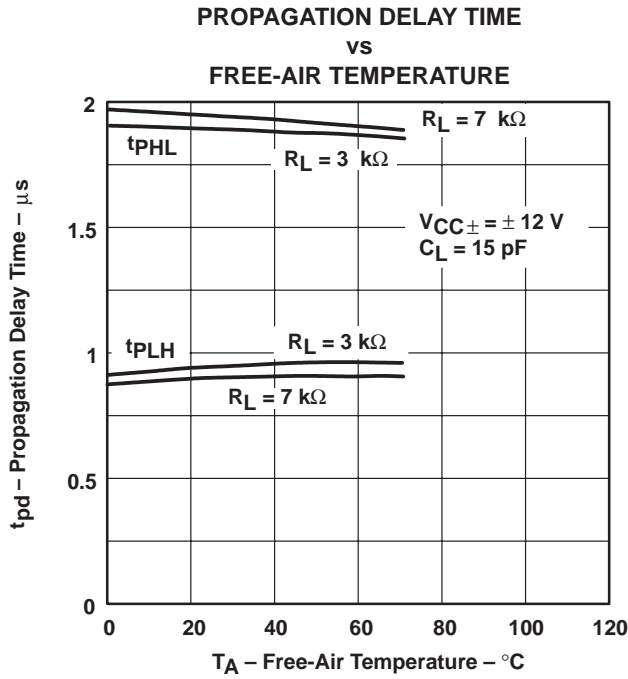

Figure 10

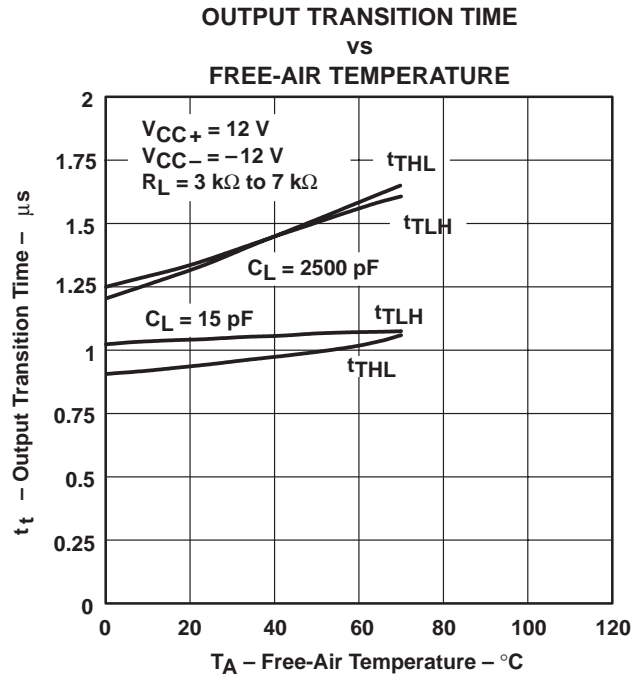

Figure 11

APPLICATION INFORMATION

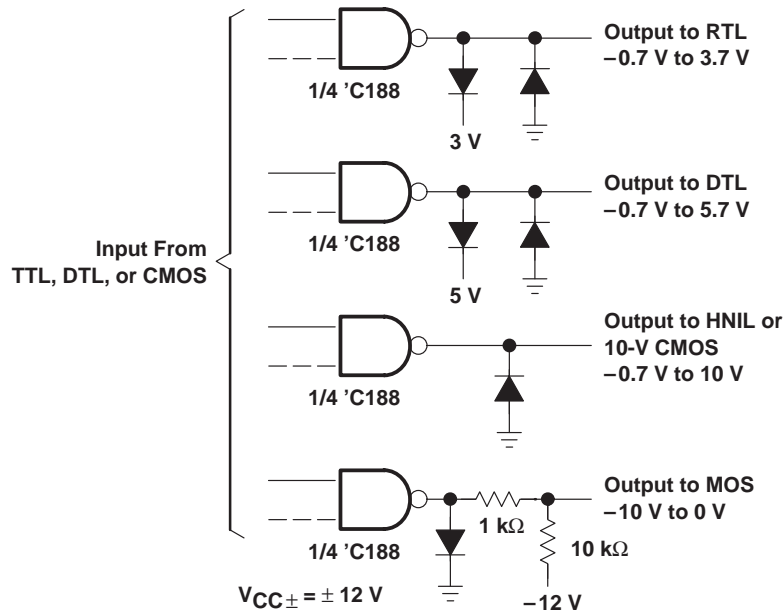
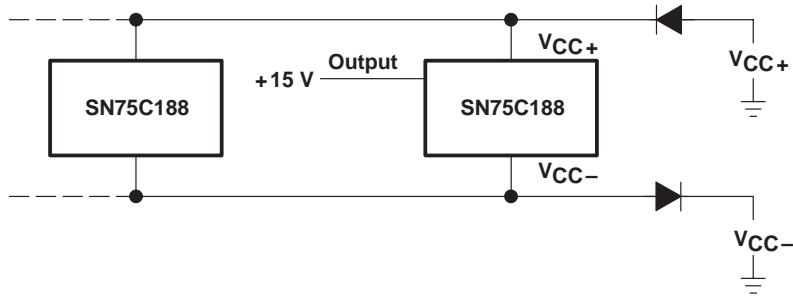

Figure 12. Logic Translator Applications



APPLICATION INFORMATION



NOTE A: External diodes placed in series with the  $V_{CC+}$  and  $V_{CC-}$  leads protect the SN75C188 in the fault condition where the device outputs are shorted to  $\pm 15$  V and the power supplies are at low voltage and provide low-impedance paths to GND.

Figure 13. Power Supply Protection to Meet Power-Off Fault Conditions of Standard EIA/TIA-232-E

**PACKAGING INFORMATION**

Orderable Device	Status (1)	Package Type	Package Drawing	Pins	Package Qty	Eco Plan (2)	Lead finish/ Ball material (6)	MSL Peak Temp (3)	Op Temp (°C)	Device Marking (4/5)	Samples
SN75C188D	LIFEBUY	SOIC	D	14	50	RoHS & Green	NIPDAU	Level-1-260C-UNLIM	0 to 70	SN75C188	
SN75C188DBR	LIFEBUY	SSOP	DB	14	2000	RoHS & Green	NIPDAU	Level-1-260C-UNLIM	0 to 70	CA188	
SN75C188DR	LIFEBUY	SOIC	D	14	2500	RoHS & Green	NIPDAU	Level-1-260C-UNLIM	0 to 70	SN75C188	
SN75C188DRE4	LIFEBUY	SOIC	D	14	2500	RoHS & Green	NIPDAU	Level-1-260C-UNLIM	0 to 70	SN75C188	
SN75C188N	LIFEBUY	PDIP	N	14	25	RoHS & Green	NIPDAU	N / A for Pkg Type	0 to 70	SN75C188N	
SN75C188NSR	LIFEBUY	SO	NS	14	2000	RoHS & Green	NIPDAU	Level-1-260C-UNLIM	0 to 70	75C188	

(1) The marketing status values are defined as follows:

**ACTIVE:** Product device recommended for new designs.

**LIFEBUY:** TI has announced that the device will be discontinued, and a lifetime-buy period is in effect.

**NRND:** Not recommended for new designs. Device is in production to support existing customers, but TI does not recommend using this part in a new design.

**PREVIEW:** Device has been announced but is not in production. Samples may or may not be available.

**OBSELETE:** TI has discontinued the production of the device.

(2) **RoHS:** TI defines "RoHS" to mean semiconductor products that are compliant with the current EU RoHS requirements for all 10 RoHS substances, including the requirement that RoHS substance do not exceed 0.1% by weight in homogeneous materials. Where designed to be soldered at high temperatures, "RoHS" products are suitable for use in specified lead-free processes. TI may reference these types of products as "Pb-Free".

**RoHS Exempt:** TI defines "RoHS Exempt" to mean products that contain lead but are compliant with EU RoHS pursuant to a specific EU RoHS exemption.

**Green:** TI defines "Green" to mean the content of Chlorine (Cl) and Bromine (Br) based flame retardants meet JS709B low halogen requirements of <=1000ppm threshold. Antimony trioxide based flame retardants must also meet the <=1000ppm threshold requirement.

(3) MSL, Peak Temp. - The Moisture Sensitivity Level rating according to the JEDEC industry standard classifications, and peak solder temperature.

(4) There may be additional marking, which relates to the logo, the lot trace code information, or the environmental category on the device.

(5) Multiple Device Markings will be inside parentheses. Only one Device Marking contained in parentheses and separated by a "~" will appear on a device. If a line is indented then it is a continuation of the previous line and the two combined represent the entire Device Marking for that device.

(6) Lead finish/Ball material - Orderable Devices may have multiple material finish options. Finish options are separated by a vertical ruled line. Lead finish/Ball material values may wrap to two lines if the finish value exceeds the maximum column width.

**Important Information and Disclaimer:**The information provided on this page represents TI's knowledge and belief as of the date that it is provided. TI bases its knowledge and belief on information provided by third parties, and makes no representation or warranty as to the accuracy of such information. Efforts are underway to better integrate information from third parties. TI has taken and

continues to take reasonable steps to provide representative and accurate information but may not have conducted destructive testing or chemical analysis on incoming materials and chemicals. TI and TI suppliers consider certain information to be proprietary, and thus CAS numbers and other limited information may not be available for release.

In no event shall TI's liability arising out of such information exceed the total purchase price of the TI part(s) at issue in this document sold by TI to Customer on an annual basis.

## TAPE AND REEL INFORMATION



### QUADRANT ASSIGNMENTS FOR PIN 1 ORIENTATION IN TAPE



\*All dimensions are nominal

Device	Package Type	Package Drawing	Pins	SPQ	Reel Diameter (mm)	Reel Width W1 (mm)	A0 (mm)	B0 (mm)	K0 (mm)	P1 (mm)	W (mm)	Pin1 Quadrant
SN75C188DBR	SSOP	DB	14	2000	330.0	16.4	8.35	6.6	2.4	12.0	16.0	Q1
SN75C188DR	SOIC	D	14	2500	330.0	16.4	6.5	9.0	2.1	8.0	16.0	Q1
SN75C188NSR	SO	NS	14	2000	330.0	16.4	8.2	10.5	2.5	12.0	16.0	Q1

**TAPE AND REEL BOX DIMENSIONS**

\*All dimensions are nominal

Device	Package Type	Package Drawing	Pins	SPQ	Length (mm)	Width (mm)	Height (mm)
SN75C188DBR	SSOP	DB	14	2000	356.0	356.0	35.0
SN75C188DR	SOIC	D	14	2500	340.5	336.1	32.0
SN75C188NSR	SO	NS	14	2000	356.0	356.0	35.0

**TUBE**

\*All dimensions are nominal

Device	Package Name	Package Type	Pins	SPQ	L (mm)	W (mm)	T (μm)	B (mm)
SN75C188D	D	SOIC	14	50	507	8	3940	4.32
SN75C188D	D	SOIC	14	50	506.6	8	3940	4.32
SN75C188N	N	PDIP	14	25	506	13.97	11230	4.32

# MECHANICAL DATA

NS (R-PDSO-G\*\*)

PLASTIC SMALL-OUTLINE PACKAGE

14-PINS SHOWN





- NOTES:
- A. All linear dimensions are in millimeters.
  - B. This drawing is subject to change without notice.
  - C. Body dimensions do not include mold flash or protrusion, not to exceed 0,15.

D (R-PDSO-G14)

PLASTIC SMALL OUTLINE



4040047-5/M 06/11

- NOTES:
- A. All linear dimensions are in inches (millimeters).
  - B. This drawing is subject to change without notice.
  -  Body length does not include mold flash, protrusions, or gate burrs. Mold flash, protrusions, or gate burrs shall not exceed 0.006 (0,15) each side.
  -  Body width does not include interlead flash. Interlead flash shall not exceed 0.017 (0,43) each side.
  - E. Reference JEDEC MS-012 variation AB.



D (R-PDSO-G14)

PLASTIC SMALL OUTLINE

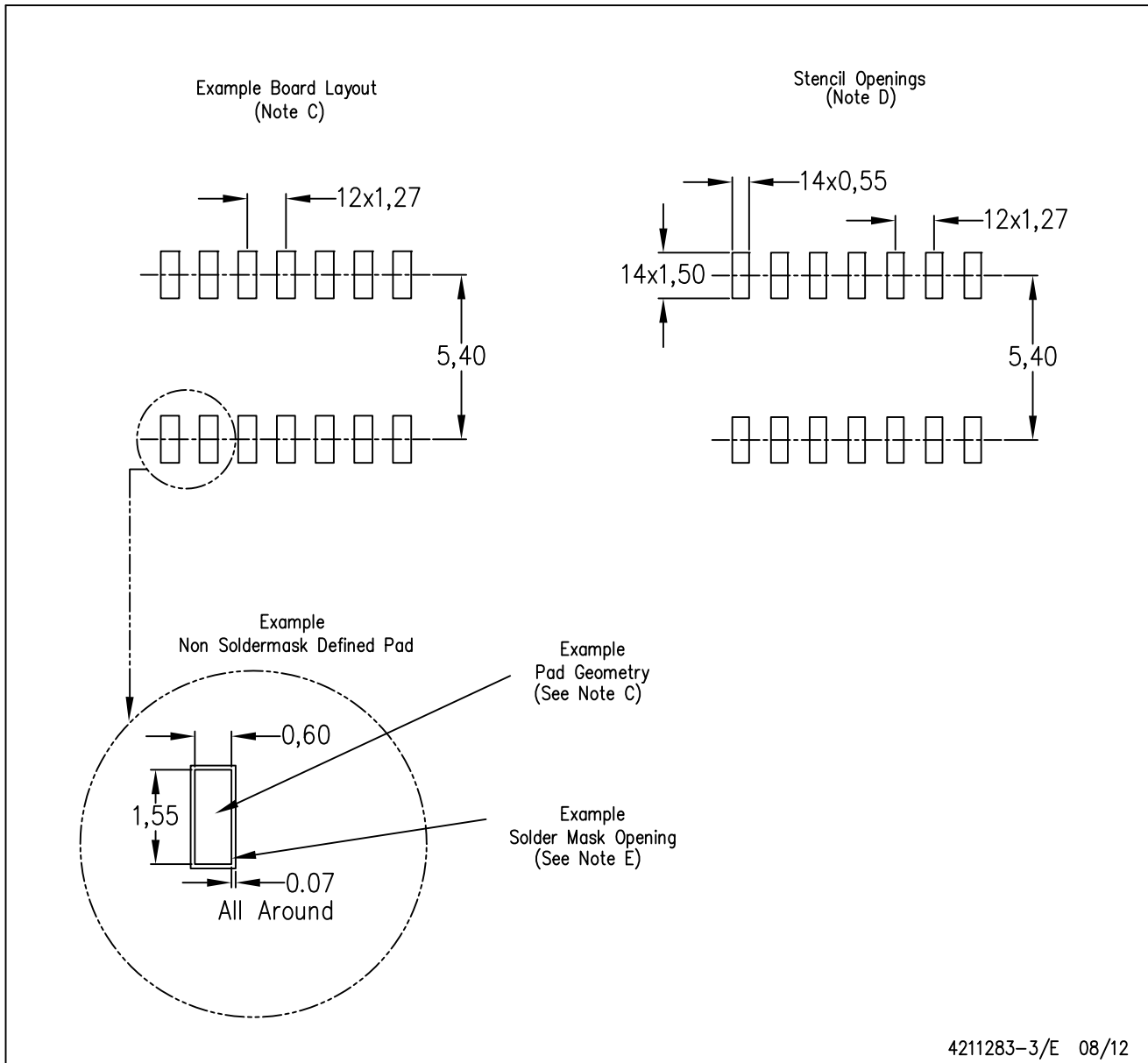

4211283-3/E 08/12

- NOTES:
- All linear dimensions are in millimeters.
  - This drawing is subject to change without notice.
  - Publication IPC-7351 is recommended for alternate designs.
  - Laser cutting apertures with trapezoidal walls and also rounding corners will offer better paste release. Customers should contact their board assembly site for stencil design recommendations. Refer to IPC-7525 for other stencil recommendations.
  - Customers should contact their board fabrication site for solder mask tolerances between and around signal pads.

N (R-PDIP-T\*\*)

PLASTIC DUAL-IN-LINE PACKAGE

16 PINS SHOWN



- NOTES:
- A. All linear dimensions are in inches (millimeters).
  - B. This drawing is subject to change without notice.
  - Falls within JEDEC MS-001, except 18 and 20 pin minimum body length (Dim A).
  - The 20 pin end lead shoulder width is a vendor option, either half or full width.

DB (R-PDSO-G\*\*)

PLASTIC SMALL-OUTLINE

28 PINS SHOWN



- NOTES: A. All linear dimensions are in millimeters.  
 B. This drawing is subject to change without notice.  
 C. Body dimensions do not include mold flash or protrusion not to exceed 0,15.  
 D. Falls within JEDEC MO-150

## IMPORTANT NOTICE AND DISCLAIMER

TI PROVIDES TECHNICAL AND RELIABILITY DATA (INCLUDING DATA SHEETS), DESIGN RESOURCES (INCLUDING REFERENCE DESIGNS), APPLICATION OR OTHER DESIGN ADVICE, WEB TOOLS, SAFETY INFORMATION, AND OTHER RESOURCES "AS IS" AND WITH ALL FAULTS, AND DISCLAIMS ALL WARRANTIES, EXPRESS AND IMPLIED, INCLUDING WITHOUT LIMITATION ANY IMPLIED WARRANTIES OF MERCHANTABILITY, FITNESS FOR A PARTICULAR PURPOSE OR NON-INFRINGEMENT OF THIRD PARTY INTELLECTUAL PROPERTY RIGHTS.

These resources are intended for skilled developers designing with TI products. You are solely responsible for (1) selecting the appropriate TI products for your application, (2) designing, validating and testing your application, and (3) ensuring your application meets applicable standards, and any other safety, security, regulatory or other requirements.

These resources are subject to change without notice. TI grants you permission to use these resources only for development of an application that uses the TI products described in the resource. Other reproduction and display of these resources is prohibited. No license is granted to any other TI intellectual property right or to any third party intellectual property right. TI disclaims responsibility for, and you will fully indemnify TI and its representatives against, any claims, damages, costs, losses, and liabilities arising out of your use of these resources.

TI's products are provided subject to [TI's Terms of Sale](#) or other applicable terms available either on [ti.com](https://www.ti.com) or provided in conjunction with such TI products. TI's provision of these resources does not expand or otherwise alter TI's applicable warranties or warranty disclaimers for TI products.

TI objects to and rejects any additional or different terms you may have proposed.

Mailing Address: Texas Instruments, Post Office Box 655303, Dallas, Texas 75265  
Copyright © 2023, Texas Instruments Incorporated