

125W STEREO / 250W MONO PurePath™ HD DIGITAL-INPUT POWER STAGE

Check for Samples: [TAS5612A](#)

FEATURES

- **PurePath™ HD Enabled Integrated Feedback Provides:**
 - **Signal Bandwidth up to 80kHz for High Frequency Content From HD Sources**
 - **Ultralow 0.03% THD at 1W into 4Ω**
 - **Ultralow 0.01% THD at 1W into 8Ω**
 - **Flat THD at all Frequencies for Natural Sound**
 - **80dB PSRR (BTL, No Input Signal)**
 - **>100dB (A weighted) SNR**
 - **Click and Pop Free Startup**
- **Pin compatible with TAS5631, TAS5616 and TAS5614**
- **Multiple Configurations Possible on the Same PCB With Stuffing Options:**
 - **Mono Parallel Bridge Tied Load (PBTL)**
 - **Stereo Bridge Tied Load (BTL)**
 - **2.1 Single Ended Stereo Pair and Bridge Tied Load Subwoofer**
- **Total Output Power at 10%THD+N**
 - **250W in Mono PBTL Configuration**
 - **125W per Channel in Stereo BTL Configuration**
- **Total Output Power in BTL configuration at 1%THD+N**
 - **130W Stereo into 3Ω**
 - **105W Stereo into 4Ω**
 - **70W Stereo into 6Ω**
 - **55W Stereo into 8Ω**
- **>90% Efficient Power Stage With 60-mΩ Output MOSFETs**
- **Self-Protection Design (Including Undervoltage, Overtemperature, Clipping, and Short-Circuit Protection) With Error Reporting**
- **EMI Compliant When Used With Recommended System Design**
- **Thermally Enhanced Package:**
 - **PHD (64-Pin QFP)**

APPLICATIONS

- **Home Theater Systems**
- **AV Receivers**
- **DVD/Blu-ray™ Disc Receivers**
- **Mini Combo Systems**
- **Active Speakers and Subwoofers**

DESCRIPTION

The TAS5612A is a high performance digital input Class D amplifier with integrated closed loop feedback technology (known as PurePath™ HD) with the ability to drive up to 125W ⁽¹⁾ Stereo into 4 to 8 Ω Speakers from a single 32.5V supply.

PurePath™ HD technology enables traditional AB-Amplifier performance (<0.03% THD) levels while providing the power efficiency of traditional class D amplifiers.

Unlike traditional Class D amplifiers, the distortion curve only increases once the output levels move into clipping.

PurePath™ HD technology enables lower idle losses making the device even more efficient.

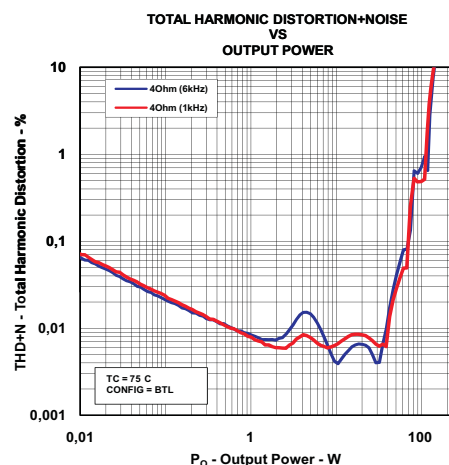

- (1) Achievable output power levels are dependent on the thermal configuration of the target application. A high performance thermal interface material between the package exposed heatslug and the heat sink should be used to achieve high output power levels.



Please be aware that an important notice concerning availability, standard warranty, and use in critical applications of Texas Instruments semiconductor products and disclaimers thereto appears at the end of this data sheet.

PurePath, Power PAD are trademarks of Texas Instruments.
All other trademarks are the property of their respective owners.



These devices have limited built-in ESD protection. The leads should be shorted together or the device placed in conductive foam during storage or handling to prevent electrostatic damage to the MOS gates.

DEVICE INFORMATION

Terminal Assignment

The package type contains a heat slug that is located on the top side of the device for convenient thermal coupling to the heat sink.

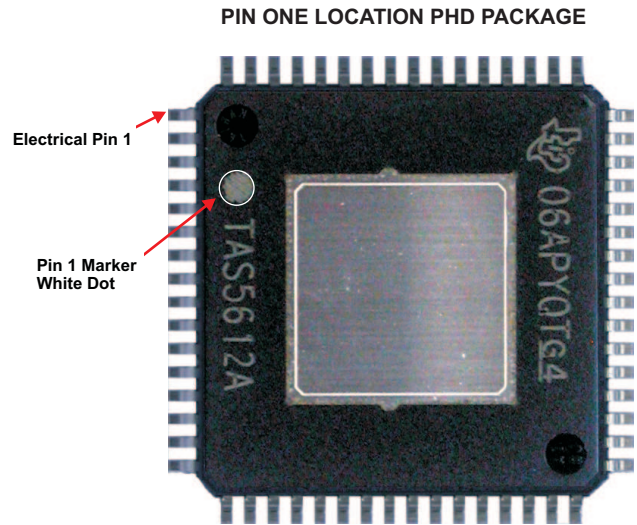
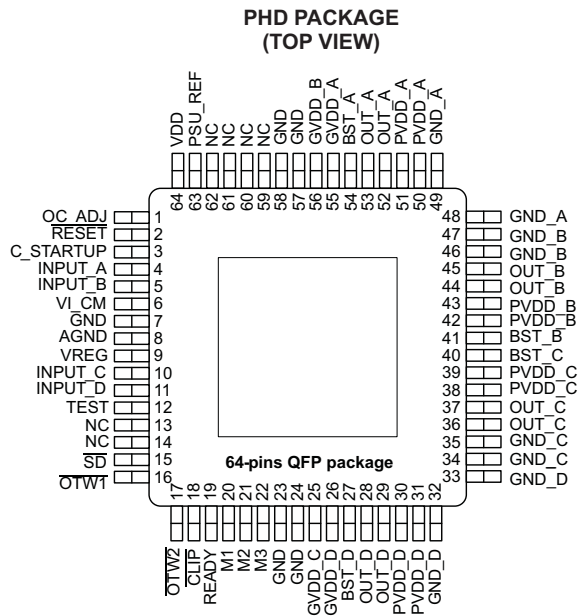

MODE SELECTION PINS

MODE PINS			PWM INPUT ⁽¹⁾	OUTPUT CONFIGURATION	DESCRIPTION		
M3	M2	M1					
0	0	0	2N	2 × BTL	AD mode		
0	0	1	—	—	Reserved		
0	1	0	2N	2 × BTL	BD mode		
0	1	1	1N	1 × BTL + 2 × SE	AD mode		
1	0	0	1N	4 × SE	AD mode		
1	0	1	2N 1N	1 × PBTL	INPUT_C ⁽²⁾	INPUT_D ⁽²⁾	
					0	0	AD mode
					1	0	BD mode
1	1	0	Reserved				
1	1	1					

(1) The 1N and 2N naming convention is used to indicate the number of PWM lines to the power stage per channel in a specific mode.

(2) INPUT_C and D are used to select between a subset of AD and BD mode operations in PBTL mode

PACKAGE HEAT DISSIPATION RATINGS⁽¹⁾

PARAMETER	TAS5612APHD
R _{θJC} (°C/W) – 2 BTL or 4 SE channels	3.2
R _{θJC} (°C/W) – 1 BTL or 2 SE channel(s)	5.4
R _{θJC} (°C/W) – 1 SE channel	7.9
Pad Area ⁽²⁾	64mm ²

(1) J_C is junction-to-case, C_H is case-to-heat sink

(2) R_{θCH} is an important consideration. Assume a 2-mil thickness of thermal grease with a thermal conductivity of 2.5 W/mK between the pad area and the heat sink and both channels active. The R_{θCH} with this condition is 1.1°C/W for the PHD package and 0.44°C/W for the DKD package.

Table 1. ORDERING INFORMATION⁽¹⁾

T _A	PACKAGE	DESCRIPTION
0°C–70°C	TAS5612APHD	64 pin HTQFP

(1) For the most current package and ordering information, see the Package Option Addendum at the end of this document, or see the TI website at www.ti.com.

ABSOLUTE MAXIMUM RATINGS

over operating free-air temperature range unless otherwise noted ⁽¹⁾

TAS5612A		UNIT	
VDD to GND	-0.3 to 13.2	V	
GVDD to GND	-0.3 to 13.2	V	
PVDD_X to GND_X ⁽²⁾	-0.3 to 53	V	
OUT_X to GND_X ⁽²⁾	-0.3 to 53	V	
BST_X to GND_X ⁽²⁾	-0.3 to 66.2	V	
BST_X to GVDD_X ⁽²⁾	-0.3 to 53	V	
VREG to GND	-0.3 to 4.2	V	
GND_X to GND	-0.3 to 0.3	V	
GND to AGND	-0.3 to 0.3	V	
OC_ADJ, M1, M2, M3, OSC_IO+, OSC_IO-, FREQ_ADJ, VI_CM, C_STARTUP, PSU_REF to GND	-0.3 to 4.2	V	
INPUT_X	-0.3 to 7	V	
RESET, SD, OTW1, OTW2, CLIP, READY to GND	-0.3 to 7	V	
Maximum continuous sink current (SD, OTW1, OTW2, CLIP, READY)	9	mA	
Maximum operating junction temperature range, T _J	0 to 150	°C	
Storage temperature, T _{stg}	-40 to 150	°C	
Electrostatic discharge	Human body model ⁽³⁾ (all pins)	±2	kV
	Charged device model ⁽³⁾ (all pins)	±500	V

- (1) Stresses beyond those listed under *Absolute Maximum Ratings* may cause permanent damage to the device. These are stress ratings only, and functional operation of the device at these or any other conditions beyond those indicated under *Recommended Operating Conditions* is not implied. Exposure to absolute-maximum-rated conditions for extended periods may affect device reliability.
- (2) These voltages represents the DC voltage + peak AC waveform measured at the terminal of the device in all conditions.
- (3) Failure to follow good anti-static ESD handling during manufacture and rework will contribute to device malfunction. Make sure the operators handling the device are adequately grounded through the use of ground straps or alternative ESD protection.

RECOMMENDED OPERATING CONDITIONS

over operating free-air temperature range (unless otherwise noted)

		MIN	TYP	MAX	UNIT
PVDD_x	Half-bridge supply	16	32.5	34.1	V
GVDD_x	Supply for logic regulators and gate-drive circuitry	10.8	12	13.2	V
VDD	Digital regulator supply voltage	10.8	12	13.2	V
R _L (BTL)	Load impedance	3.5	4	Ω	
R _L (SE)		1.8	2		
R _L (PBTL)		1.6	2		
R _L (BTL)	Load Impedance	2.8	3	Ω	
L _{OUTPUT} (BTL)	Output filter inductance	7	10	μH	
L _{OUTPUT} (SE)		7	15		
L _{OUTPUT} (PBTL)		7	10		
F _{PWM}	PWM frame rate	352	384	500	kHz
C _{PVDD}	PVDD close decoupling capacitors	2.0		μF	
R _{OC}	Over-current programming resistor	22	30	kΩ	
R _{OC_LACTHED}	Over-current programming resistor	47	64	kΩ	
T _J	Junction temperature	0	125	°C	

PIN FUNCTIONS

PIN		Function ⁽¹⁾	DESCRIPTION
NAME	PHD NO.		
AGND	8	P	Analog ground
BST_A	54	P	HS bootstrap supply (BST), external 0.033μF capacitor to OUT_A required.
BST_B	41	P	HS bootstrap supply (BST), external 0.033μF capacitor to OUT_B required.
BST_C	40	P	HS bootstrap supply (BST), external 0.033μF capacitor to OUT_C required.
BST_D	27	P	HS bootstrap supply (BST), external 0.033μF capacitor to OUT_D required.
CLIP	18	O	Clipping warning; open drain; active low
C_STARTUP	3	O	Startup ramp requires a charging capacitor of 4.7nF to GND
TEST	12	I	Connect to VREG node
GND	7, 23, 24, 57, 58	P	Ground
GND_A	48, 49	P	Power ground for half-bridge A
GND_B	46, 47	P	Power ground for half-bridge B
GND_C	34, 35	P	Power ground for half-bridge C
GND_D	32, 33	P	Power ground for half-bridge D
GVDD_A	55	P	Gate drive voltage supply requires 0.1μF capacitor to GND
GVDD_B	56	P	Gate drive voltage supply requires 0.1μF capacitor to GND
GVDD_C	25	P	Gate drive voltage supply requires 0.1μF capacitor to GND
GVDD_D	26	P	Gate drive voltage supply requires 0.1μF capacitor to GND
GVDD_AB	—	P	Gate drive voltage supply requires 0.22μF capacitor to GND
GVDD_CD	—	P	Gate drive voltage supply requires 0.22μF capacitor to GND
INPUT_A	4	I	Input signal for half bridge A
INPUT_B	5	I	Input signal for half bridge B
INPUT_C	10	I	Input signal for half bridge C
INPUT_D	11	I	Input signal for half bridge D
M1	20	I	Mode selection
M2	21	I	Mode selection
M3	22	I	Mode selection
NC	59–62	—	No connect, pins may be grounded.
NC	13, 14	—	No connect, pins may be grounded.
OC_ADJ	1	O	Analog overcurrent programming pin requires resistor to ground.
OTW	—	O	Overtemperature warning signal, open drain, active low.
OTW1	16	O	Overtemperature warning signal, open drain, active low.
OTW2	17	O	Overtemperature warning signal, open drain, active low.
OUT_A	52, 53	O	Output, half bridge A
OUT_B	44, 45	O	Output, half bridge B
OUT_C	36, 37	O	Output, half bridge C
OUT_D	28, 29	O	Output, half bridge D
PSU_REF	63	P	PSU Reference requires close decoupling of 4.7μF to GND
PVDD_A	50, 51	P	Power supply input for half bridge A requires close decoupling of 2μF capacitor GND_A
PVDD_B	42, 43	P	Power supply input for half bridge B requires close decoupling of 2μF capacitor GND_B
PVDD_C	38, 39	P	Power supply input for half bridge C requires close decoupling of 2μF capacitor GND_C
PVDD_D	30, 31	P	Power supply input for half bridge D requires close decoupling of 2μF capacitor GND_D
READY	19	O	Normal operation; open drain; active high
RESET	2	I	Device reset Input; active low
SD	15	O	Shutdown signal, open drain, active low
VDD	64	P	Power supply for digital voltage regulator requires a 47μF capacitor in parallel with a 0.1μF capacitor to GND for decoupling.
VI_CM	6	O	Analog comparator reference node requires close decoupling of 4.7μF to GND
VREG	9	P	Digital regulator supply filter pin requires 0.1μF capacitor to GND

(1) I = Input, O = Output, P = Power

TYPICAL SYSTEM BLOCK DIAGRAM

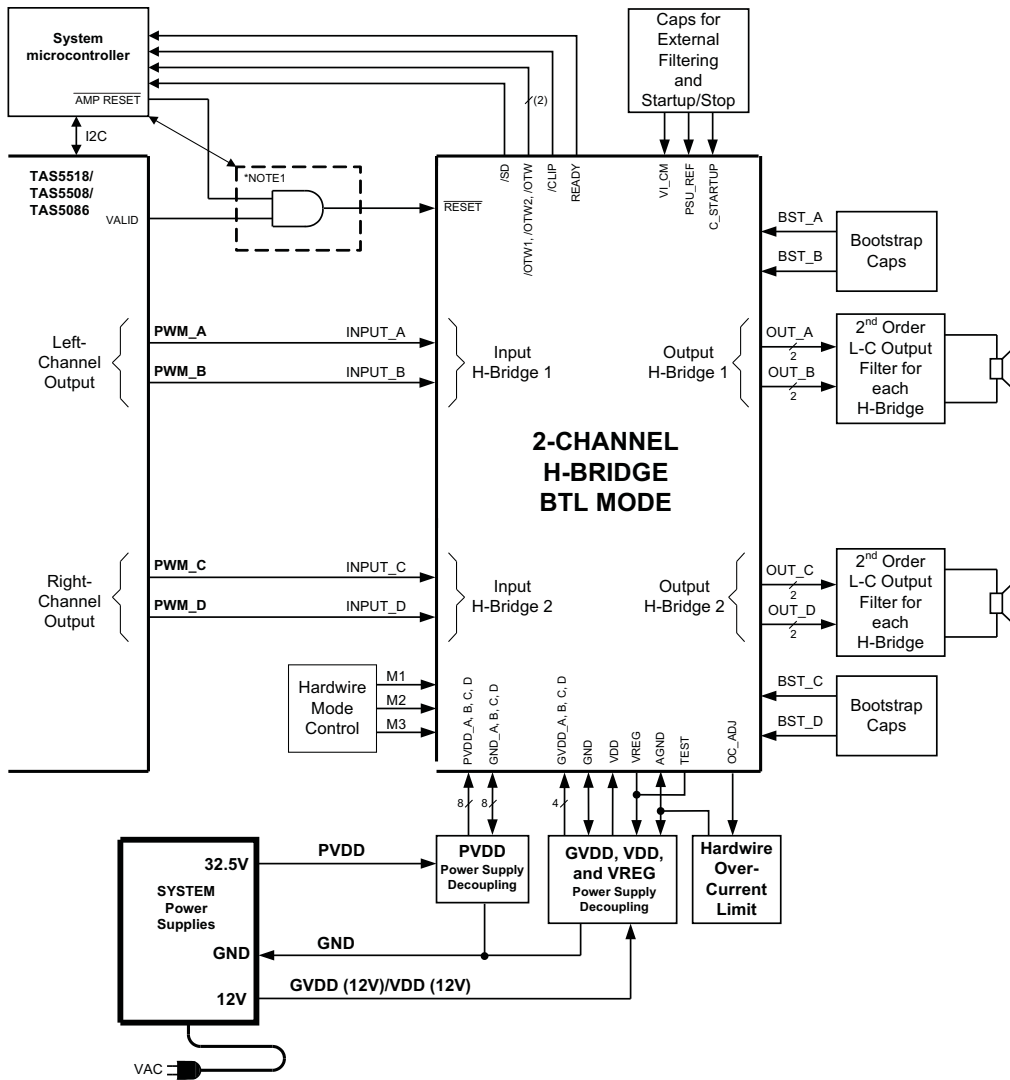

(1) Logic AND is inside or outside the micro controller.

FUNCTIONAL BLOCK DIAGRAM

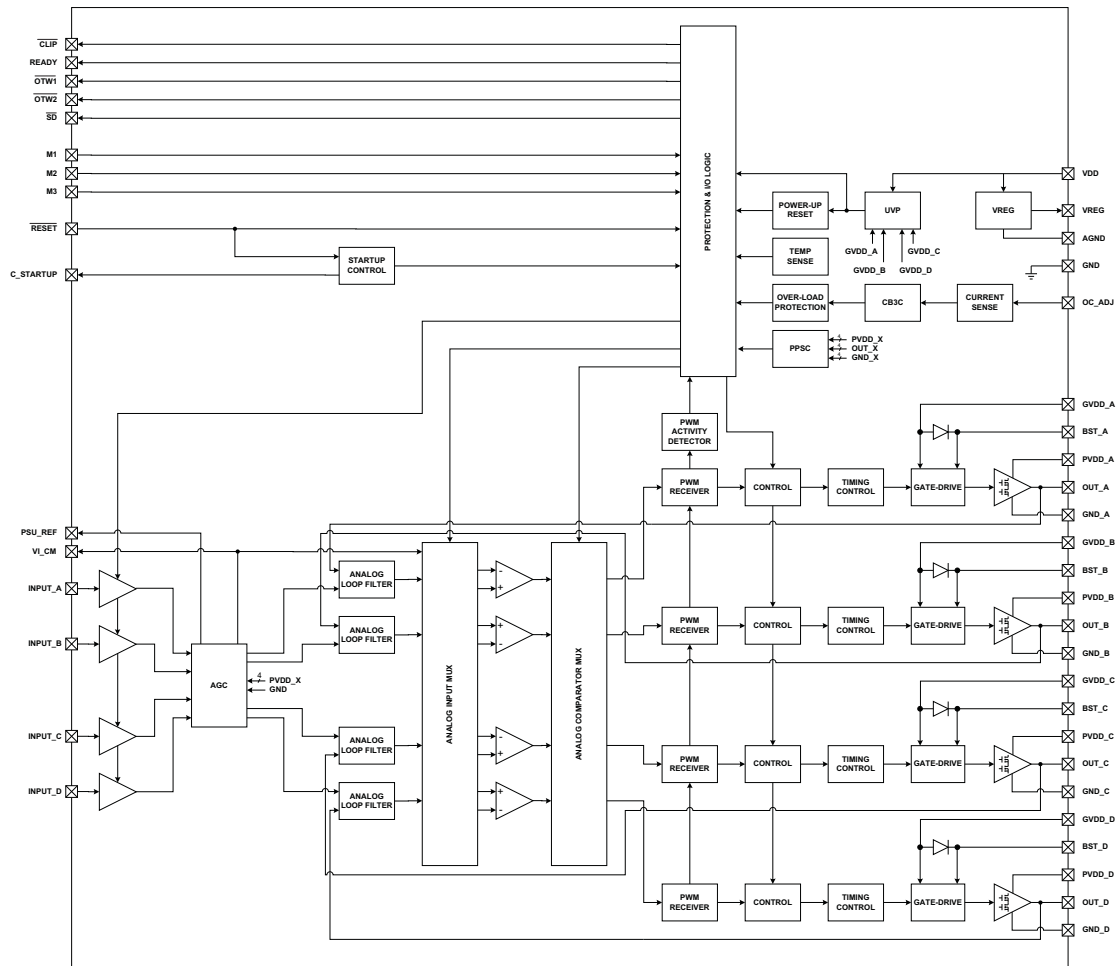

AUDIO CHARACTERISTICS (BTL)

Audio performance is recorded as a chipset consisting of a TAS5518 PWM Processor (modulation index limited to 97.7%) and a TAS5612A power stage. PCB and system configurations are in accordance with recommended guidelines. Audio frequency = 1kHz, PVDD_X = 32.5V, GVDD_X = 12V, R_L = 4Ω, f_s = 384 kHz, R_{OC} = 30kΩ, T_C = 75°C, Output Filter: L_{DEM} = 7μH, C_{DEM} = 680nF, MODE = 000, unless otherwise noted.

PARAMETER		TEST CONDITIONS	MIN	TYP	MAX	UNIT
P _O	Power output per channel	R _L = 3Ω, 10% THD+N (ROC=22kΩ, add Schottky diodes from OUT_X to GND_X)		165		W
		R _L = 4Ω, 10% THD+N		125		
		R _L = 3Ω, 1% THD+N (ROC=22kΩ, add Schottky diodes from OUT_X to GND_X)		130		
		R _L = 4Ω, 1% THD+N		105		
THD+N	Total harmonic distortion + noise	1 W, R _L = 4Ω		0.03%		
		1 W, R _L = 8Ω		0.01%		
V _n	Output integrated noise	A-weighted, TAS5518 Modulator		114		μV
V _{OS}	Output offset voltage	No signal		5	18	mV
SNR	Signal-to-noise ratio ⁽¹⁾	A-weighted, TAS5518 Modulator		103		dB
DNR	Dynamic range	A-weighted, input level –60 dBFS using TAS5518 modulator		103		dB
P _{idle}	Power dissipation due to Idle losses (I _{PVDD_X})	P _O = 0, 4 channels switching ⁽²⁾		2		W

(1) SNR is calculated relative to 1% THD-N output level.

(2) Actual system idle losses also are affected by core losses of output inductors.

AUDIO CHARACTERISTICS (PBTL)

Audio performance is recorded as a chipset consisting of a TAS5518 PWM Processor (modulation index limited to 97.7%) and a TAS5612A power stage. PCB and system configurations are in accordance with recommended guidelines. Audio frequency = 1kHz, PVDD_X = 32.5V, GVDD_X = 12V, R_L = 2Ω, f_s = 384kHz, R_{OC} = 30kΩ, T_C = 75°C, Output Filter: L_{DEM} = 7μH, C_{DEM} = 1μF, MODE = 101-00, unless otherwise noted.

PARAMETER		TEST CONDITIONS	MIN	TYP	MAX	UNIT
P _O	Power output per channel	R _L = 2Ω, 10%, THD+N		250		W
		R _L = 3Ω, 10% THD+N		165		
		R _L = 4Ω, 10% THD+N		125		
		R _L = 2Ω, 1% THD+N		210		
		R _L = 3Ω, 1% THD+N		135		
		R _L = 4Ω, 1% THD+N		105		
THD+N	Total harmonic distortion + noise	1 W		0.03%		
V _n	Output integrated noise	A-weighted, TAS5518 Modulator		120		μV
SNR	Signal to noise ratio ⁽¹⁾	A-weighted, TAS5518 Modulator		103		dB
DNR	Dynamic range	A-weighted, input level –60 dBFS using TAS5518 modulator		103		dB
P _{idle}	Power dissipation due to idle losses (I _{PVDD_X})	P _O = 0, 4 channels switching ⁽²⁾		1.7		W

(1) SNR is calculated relative to 1% THD-N output level.

(2) Actual system idle losses are affected by core losses of output inductors.

ELECTRICAL CHARACTERISTICS

PVDD_X = 32.5V, GVDD_X = 12V, VDD = 12V, T_C (Case temperature) = 75°C, f_s = 384kHz, unless otherwise specified.

PARAMETER		TEST CONDITIONS	MIN	TYP	MAX	UNIT
INTERNAL VOLTAGE REGULATOR AND CURRENT CONSUMPTION						
VREG	Voltage regulator, only used as reference node, VREG	VDD = 12V	3	3.3	3.6	V
VI_CM	Analog comparator reference node, VI_CM		1.5	1.75	1.9	V
I _{VDD}	VDD supply current	Operating, 50% duty cycle		20		mA
		Idle, reset mode		20		
I _{GVDD_x}	Gate-supply current per half-bridge	50% duty cycle		10		mA
		Reset mode		1.5		
I _{PVDD_x}	Half-bridge idle current	50% duty cycle without output filter or load		15		mA
		Reset mode, No switching		540		
OUTPUT-STAGE MOSFETS						
R _{DS(on)}	Drain-to-source resistance, low side (LS)	T _J = 25°C, excludes metallization resistance, GVDD = 12V		60	100	mΩ
	Drain-to-source resistance, high side (HS)			60	100	
I/O PROTECTION						
V _{uvp,G}	Undervoltage protection limit, GVDD_x, VDD			9.5		V
V _{uvp,hyst} ⁽¹⁾				0.6		V
OTW1 ⁽¹⁾	Overtemperature warning 1		95	100	105	°C
OTW2 ⁽¹⁾	Overtemperature warning 2		115	125	135	°C
OTW _{hyst} ⁽¹⁾	Temperature drop needed below OTW temperature for OTW to be inactive after OTW event.			25		°C
OTE ⁽¹⁾	Overtemperature error		145	155	165	°C
	OTE-OTW differential			30		
OTE _{HYST} ⁽¹⁾	A reset needs to occur for \overline{SD} to be released following an OTE event			25		°C
OLPC	Overload protection counter	f _{PWM} = 384kHz		2.6		ms
I _{OC}	Overcurrent limit protection	Resistor – programmable, nominal peak current in 1Ω load, R _{OCP} = 30kΩ		12.6		A
		Resistor – programmable, nominal peak current in 1Ω load, R _{OCP} = 22kΩ (With Schottky diodes from OUT_X to GND_X)		16.3		
	Overcurrent limit protection, latched	Resistor – programmable, nominal peak current in 1Ω load, R _{OCP} = 64kΩ		12.6		A
		Resistor – programmable, nominal peak current in 1Ω load, R _{OCP} = 47kΩ (With Schottky diodes from OUT_X to GND_X)		16.3		
I _{OCT}	Overcurrent response time	Time from application of short condition to Hi-Z of affected half bridge		150		ns
I _{PD}	Internal pulldown resistor at output of each half bridge	Connected when \overline{RESET} is active to provide bootstrap charge. Not used in SE mode.		3		mA

(1) Specified by design.

ELECTRICAL CHARACTERISTICS (continued)

PVDD_X = 32.5V, GVDD_X = 12V, VDD = 12V, T_C (Case temperature) = 75°C, f_S = 384kHz, unless otherwise specified.

PARAMETER		TEST CONDITIONS	MIN	TYP	MAX	UNIT
STATIC DIGITAL SPECIFICATIONS						
V _{IH}	High level input voltage	INPUT_X, M1, M2, M3, RESET	1.9			V
V _{IL}	Low level input voltage				0.8	V
I _{lkg}	Input leakage current				100	μA
OTW/SHUTDOWN (SD)						
R _{INT_PU}	Internal pullup resistance, $\overline{OTW1}$ to VREG, $\overline{OTW2}$ to VREG, \overline{SD} to VREG		20	26	33	kΩ
V _{OH}	High level output voltage	Internal pullup resistor	3	3.3	3.6	V
		External pullup of 4.7kΩ to 5V	4.5		5	
V _{OL}	Low level output voltage	I _O = 4mA		200	500	mV
FANOUT	Device fanout $\overline{OTW1}$, $\overline{OTW2}$, \overline{SD} , \overline{CLIP} , \overline{READY}	No external pullup		30		devices

TYPICAL CHARACTERISTICS, BTL CONFIGURATION

TOTAL HARMONIC+NOISE
vs
OUTPUT POWER

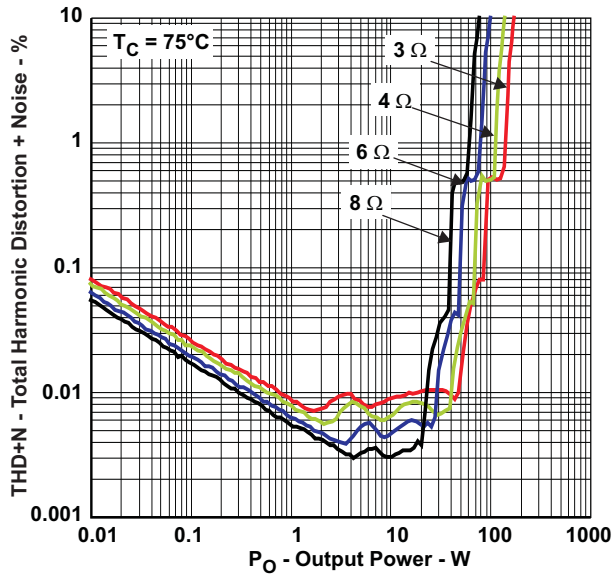

Figure 1.

OUTPUT POWER
vs
SUPPLY VOLTAGE

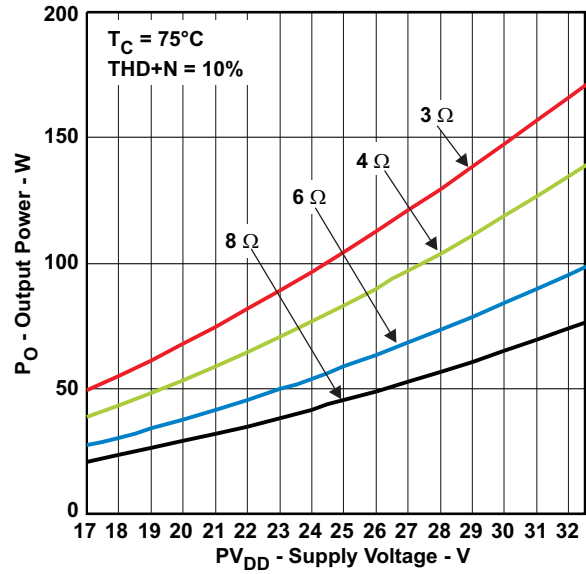

Figure 2.

UNCLIPPED OUTPUT POWER
vs
SUPPLY VOLTAGE

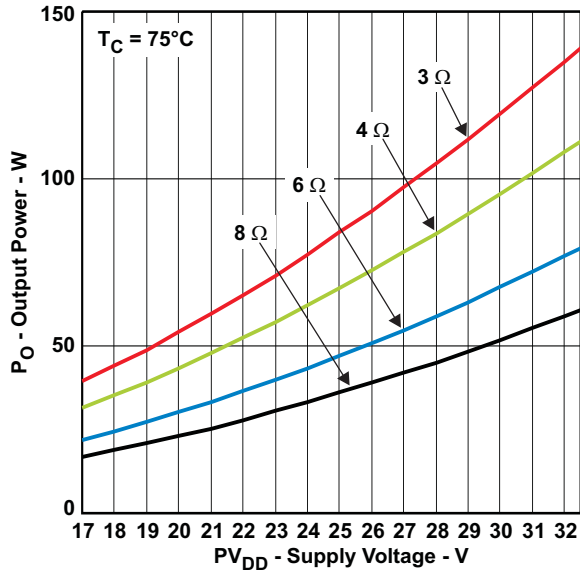

Figure 3.

SYSTEM EFFICIENCY
vs
OUTPUT POWER

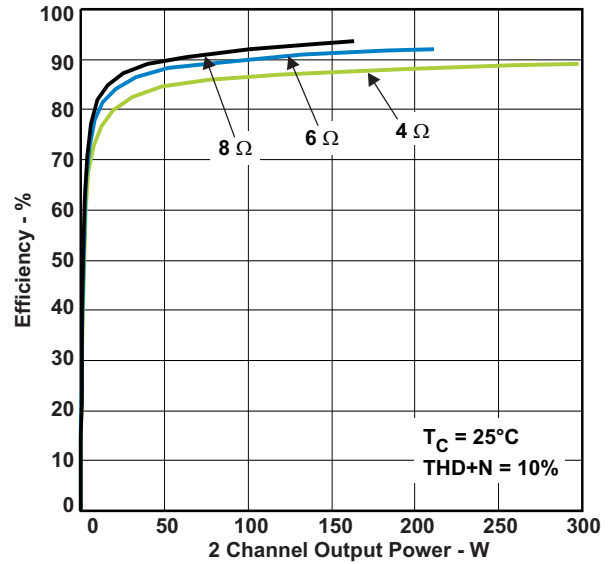

Figure 4.

TYPICAL CHARACTERISTICS, BTL CONFIGURATION (continued)

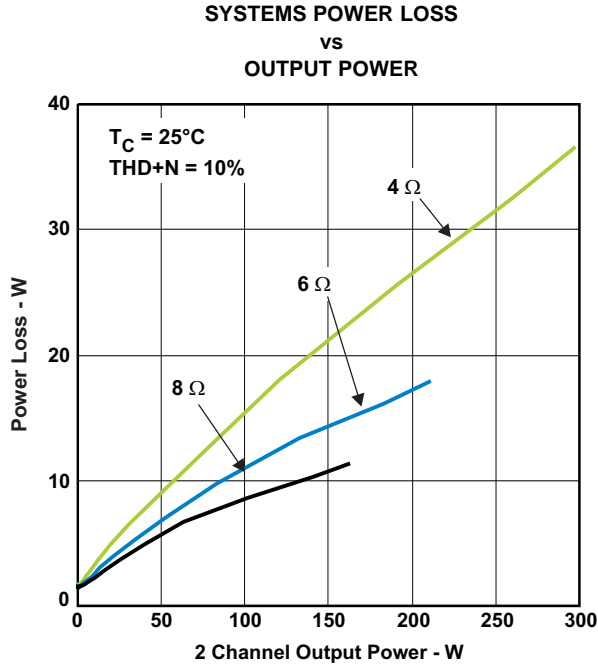

Figure 5.

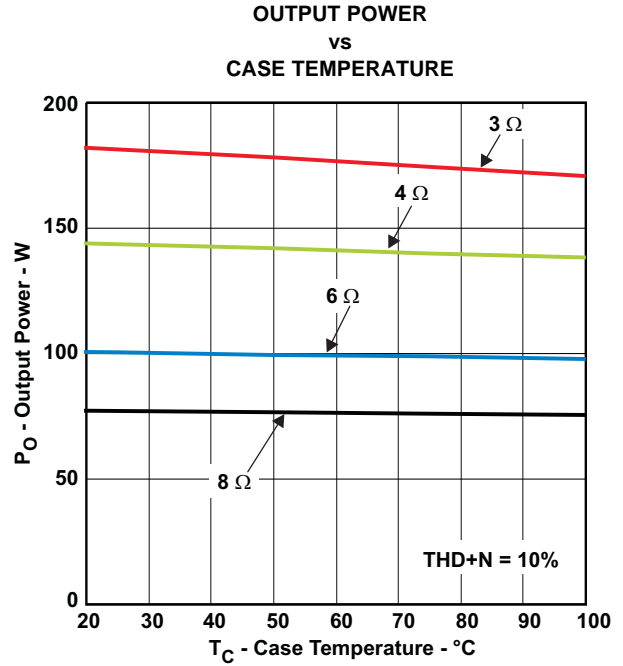

Figure 6.

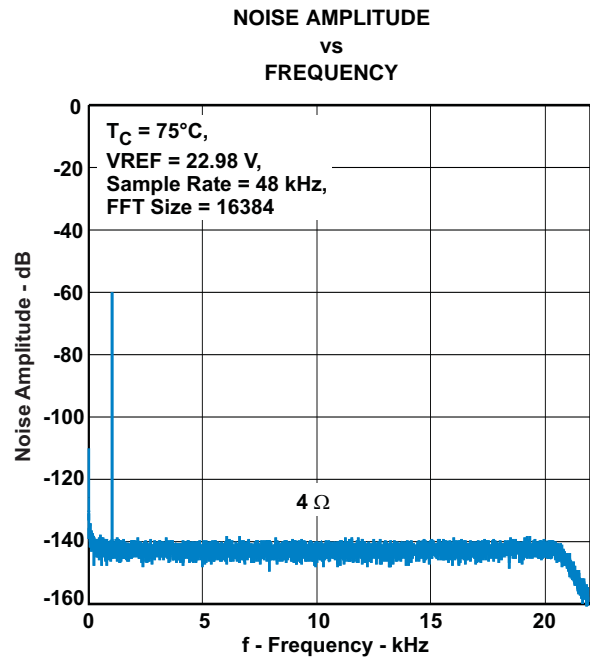

Figure 7.

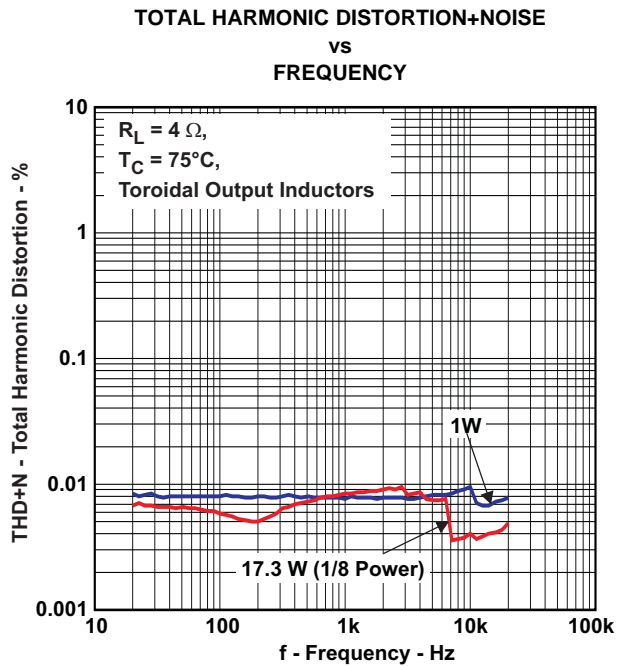

Figure 8.

TYPICAL CHARACTERISTICS, PBTL CONFIGURATION

TOTAL HARMONIC+NOISE
vs
OUTPUT POWER

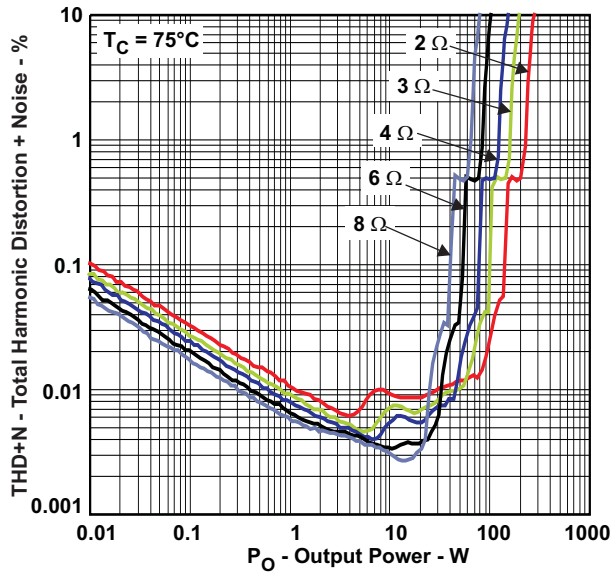

Figure 9.

OUTPUT POWER
vs
SUPPLY VOLTAGE

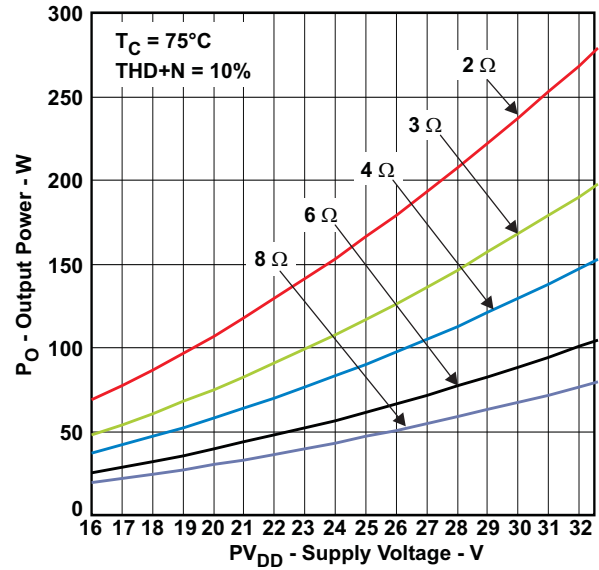

Figure 10.

OUTPUT POWER
vs
CASE TEMPERATURE

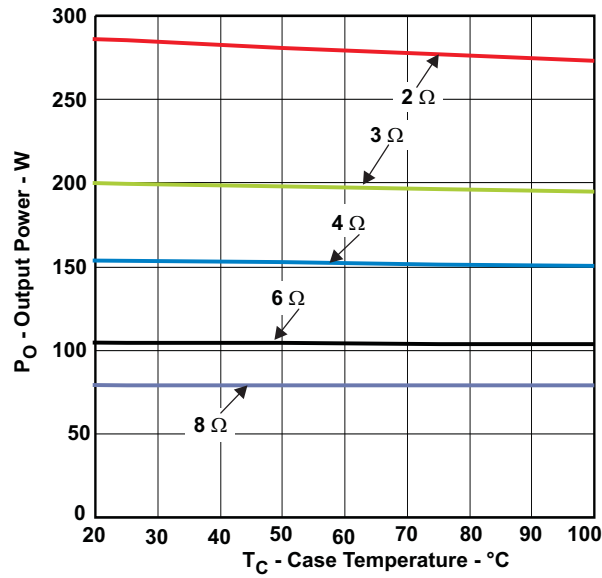

Figure 11.

APPLICATION INFORMATION

PCB MATERIAL RECOMMENDATION

FR-4 Glass Epoxy material with 2oz. (70 μ m) is recommended for use with the TAS5612A. The use of this material can provide for higher power output, improved thermal performance, and better EMI margin (due to lower PCB trace inductance).

PVDD CAPACITOR RECOMMENDATION

The large capacitors used in conjunction with each full-bridge, are referred to as the PVDD Capacitors. These capacitors should be selected for proper voltage margin and adequate capacitance to support the power requirements. In practice, with a well designed system power supply, 1000 μ F, 50V support more applications. The PVDD capacitors should be low ESR type because they are used in a circuit associated with high-speed switching.

DECOUPLING CAPACITOR RECOMMENDATION

To design an amplifier that has robust performance, passes regulatory requirements, and exhibits good audio performance, good quality decoupling capacitors should be used. In practice, X7R should be used in this application.

The voltage of the decoupling capacitors should be selected in accordance with good design practices. Temperature, ripple current, and voltage overshoot must be considered. This fact is particularly true in the selection of the 0.1 μ F that is placed on the power supply to each half-bridge. It must withstand the voltage overshoot of the PWM switching, the heat generated by the amplifier during high power output, and the ripple current created by high power output. A minimum voltage rating of 50V is required for use with a 32.5v power supply.

SYSTEM DESIGN RECOMMENDATIONS

The following schematics and PCB layouts illustrate *best practices* in the use of the TAS5612A.

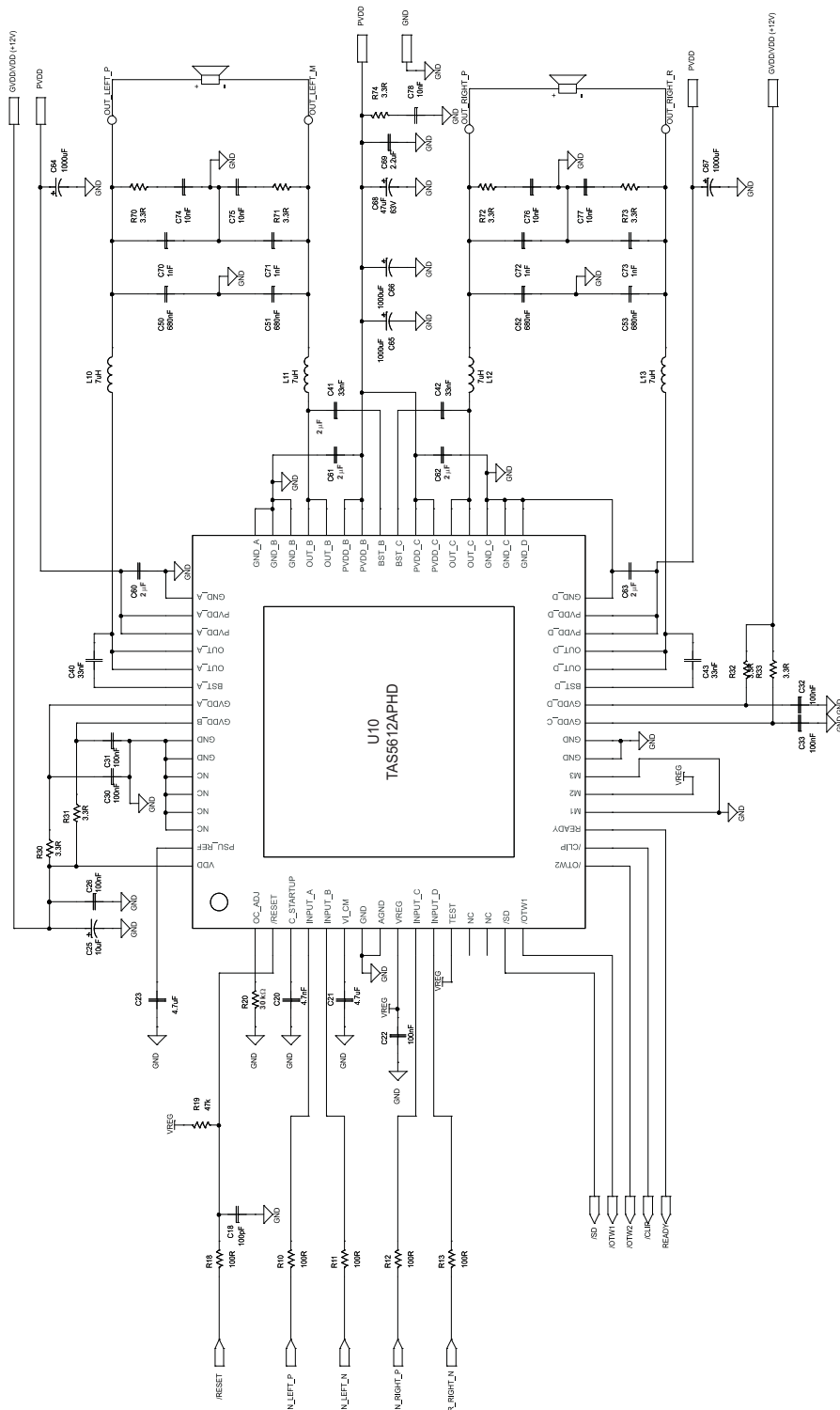

Figure 12. Typical Differential (2N) BTL Application With BD Modulation Filters

THEORY OF OPERATION

POWER SUPPLIES

To facilitate system design, the TAS5612A needs only a 12V supply in addition to the (typical) 32.5V power-stage supply. An internal voltage regulator provides suitable voltage levels for the digital and low-voltage analog circuitry. Additionally, all circuitry requiring a floating voltage supply, e.g., the high-side gate drive, is accommodated by built-in bootstrap circuitry requiring only an external capacitor for each half-bridge.

To provide outstanding electrical and acoustical characteristics, the PWM signal path including gate drive and output stage is designed as identical, independent half-bridges. For this reason, each half-bridge has separate gate drive supply (GVDD_X), bootstrap pins (BST_X), and power-stage supply pins (PVDD_X). Furthermore, an additional pin (VDD) is provided as supply for all common circuits. Although supplied from the same 12 V source, it is highly recommended to separate GVDD_A, GVDD_B, GVDD_C, GVDD_D, and VDD on the printed-circuit board (PCB) by RC filters (see application diagram for details). These RC filters provide the recommended high-frequency isolation. Special attention should be paid to placing all decoupling capacitors as close to their associated pins as possible. In general, inductance between the power supply pins and decoupling capacitors must be avoided. (See reference board documentation for additional information.)

For a properly functioning bootstrap circuit, a small ceramic capacitor must be connected from each bootstrap pin (BST_X) to the power-stage output pin (OUT_X). When the power-stage output is low, the bootstrap capacitor is charged through an internal diode connected between the gate-drive power-supply pin (GVDD_X) and the bootstrap pin. When the power-stage output is high, the bootstrap capacitor potential is shifted above the output potential and thus provides a suitable voltage supply for the high-side gate driver. In an application with PWM switching frequencies in the range from 300kHz to 4000kHz, it is recommended to use 33nF ceramic capacitors, size 0603 or 0805, for the bootstrap supply. These 33-nF capacitors ensure sufficient energy storage, even during minimal PWM duty cycles, to keep the high-side power stage FET (LDMOS) fully turned on during the remaining part of the PWM cycle.

Special attention should be paid to the power-stage power supply; this includes component selection, PCB placement, and routing. As indicated, each half-bridge has independent power-stage supply pins (PVDD_X). For optimal electrical performance, EMI compliance, and system reliability, it is important that each PVDD_X pin is decoupled with a 2 μ F ceramic capacitor placed as close as possible to each supply pin. It is recommended to follow the PCB layout of the TAS5612A reference design. For additional information on recommended power supply and required components, see the application diagrams in this data sheet.

The 12V supply should be from a low-noise, low-output-impedance voltage regulator. Likewise, the 32.5V power-stage supply is assumed to have low output impedance and low noise. The power-supply sequence is not critical as facilitated by the internal power-on-reset circuit. Moreover, the TAS5612A is fully protected against erroneous power-stage turn on due to parasitic gate charging. Thus, voltage-supply ramp rates (dV/dt) are non-critical within the specified range (see the [Recommended Operating Conditions](#) table of this data sheet).

SYSTEM POWER-UP/POWER-DOWN SEQUENCE

Powering Up

The TAS5612A does not require a power-up sequence. The outputs of the H-bridges remain in a high-impedance state until the gate-drive supply voltage (GVDD_X) and VDD voltage are above the undervoltage protection (UVP) voltage threshold (see the [Electrical Characteristics](#) table of this data sheet). Although not specifically required, it is recommended to hold RESET in a low state while powering up the device. This allows an internal circuit to charge the external bootstrap capacitors by enabling a weak pulldown of the half-bridge output.

Powering Down

The TAS5612A does not require a power-down sequence. The device remains fully operational as long as the gate-drive supply (GVDD_X) voltage and VDD voltage are above the undervoltage protection (UVP) voltage threshold (see the [Electrical Characteristics](#) table of this data sheet). Although not specifically required, it is a good practice to hold RESET low during power down, thus preventing audible artifacts including pops or clicks.

ERROR REPORTING

The \overline{SD} , \overline{OTW} , $\overline{OTW1}$ and $\overline{OTW2}$ pins are active-low, open-drain outputs. Their function is for protection-mode signaling to a PWM controller or other system-control device.

Any fault resulting in device shutdown is signaled by the \overline{SD} pin going low. Likewise, \overline{OTW} and $\overline{OTW2}$ goes low when the device junction temperature exceeds 125°C and $\overline{OTW1}$ goes low when the junction temperature exceeds 100°C (see the following table).

\overline{SD}	$\overline{OTW1}$	$\overline{OTW2}$, \overline{OTW}	DESCRIPTION
0	0	0	Overtemperature (OTE) or overload (OLP) or undervoltage (UVP)
0	0	1	Overload (OLP) or undervoltage (UVP). Junction temperature higher than 100°C (overtemperature warning)
0	1	1	Overload (OLP) or undervoltage (UVP)
1	0	0	Junction temperature higher than 125°C (overtemperature warning)
1	0	1	Junction temperature higher than 100°C (overtemperature warning)
1	1	1	Junction temperature lower than 100°C and no OLP or UVP faults (normal operation)

Note that asserting \overline{RESET} low forces the \overline{SD} signal high, independent of faults being present. TI recommends monitoring the \overline{OTW} signal using the system micro controller and responding to an overtemperature warning signal by, e.g., turning down the volume to prevent further heating of the device resulting in device shutdown (OTE).

To reduce external component count, an internal pullup resistor to 3.3V is provided on both \overline{SD} and \overline{OTW} outputs. Level compliance for 5V logic can be obtained by adding external pullup resistors to 5V (see the [Electrical Characteristics](#) table of this data sheet for further specifications).

DEVICE PROTECTION SYSTEM

The TAS5612A contains advanced protection circuitry carefully designed to facilitate system integration and ease of use, as well as to safeguard the device from permanent failure due to a wide range of fault conditions such as short circuits, overload, overtemperature, and undervoltage. The TAS5612A responds to a fault by immediately setting the power stage in a high-impedance (Hi-Z) state and asserting the \overline{SD} pin low. In situations other than overload and overtemperature error (OTE), the device automatically recovers when the fault condition has been removed, i.e., the supply voltage has increased.

The device will function on errors, as shown in the following table.

BTL Mode		PBTL Mode		SE Mode	
Local Error In	Turns Off	Local Error In	Turns Off	Local Error In	Turns Off
A	A+B	A	A+B+C+D	A	A+B
B		B		B	
C	C+D	C		C	C+D
D		D		D	

Bootstrap UVP does not shutdown according to the table, it shuts down the respective halfbridge.

PIN-TO-PIN SHORT CIRCUIT PROTECTION (PPSC)

The PPSC detection system protects the device from permanent damage if a power output pin (OUT_X) is shorted to GND_X or PVDD_X. For comparison, the OC protection system detects an over current after the demodulation filter where PPSC detects shorts directly at the pin before the filter. PPSC detection is performed at startup i.e. when VDD is supplied, consequently a short to either GND_X or PVDD_X after system startup will not activate the PPSC detection system. When PPSC detection is activated by a short on the output, all half bridges are kept in a Hi-Z state until the short is removed, the device then continues the startup sequence and starts switching. The detection is controlled globally by a two step sequence. The first step ensures that there are no shorts from OUT_X to GND_X, the second step tests that there are no shorts from OUT_X to PVDD_X. The total duration of this process is roughly proportional to the capacitance of the output LC filter. The typical duration is

<15 ms/μF. While the PPSC detection is in progress, \overline{SD} is kept low, and the device will not react to changes applied to the \overline{RESET} pins. If no shorts are present the PPSC detection passes, and \overline{SD} is released. A device reset will not start a new PPSC detection. PPSC detection is enabled in BTL and PBTL output configurations, the detection is not performed in SE mode. To make sure not to trip the PPSC detection system it is recommended not to insert resistive load to GND_X or PVDD_X.

OVERTEMPERATURE PROTECTION

PHD Package

The TAS5612A PHD package option has a three-level temperature-protection system that asserts an active-low warning signal (OTW1) when the device junction temperature exceeds 100°C (typical), (OTW2) when the device junction temperature exceeds 125°C (typical) and, if the device junction temperature exceeds 155°C (typical), the device is put into thermal shutdown, resulting in all half-bridge outputs being set in the high-impedance (Hi-Z) state and \overline{SD} being asserted low. OTE is latched in this case. To clear the OTE latch, \overline{RESET} must be asserted. Thereafter, the device resumes normal operation.

UNDERVOLTAGE PROTECTION (UVP) AND POWER-ON RESET (POR)

The UVP and POR circuits of the TAS5612A fully protect the device in any power-up/down and brownout situation. While powering up, the POR circuit resets the overload circuit (OLP) and ensures that all circuits are fully operational when the GVDD_X and VDD supply voltages reach stated in the [Electrical Characteristics](#) table. Although GVDD_X and VDD are independently monitored, a supply voltage drop below the UVP threshold on any VDD or GVDD_X pin results in all half-bridge outputs immediately being set in the high-impedance (Hi-Z) state and \overline{SD} being asserted low. The device automatically resumes operation when all supply voltages have increased above the UVP threshold.

DEVICE RESET

When \overline{RESET} is asserted low, all power-stage FETs in the four half-bridges are forced into a high-impedance (Hi-Z) state.

In BTL modes, to accommodate bootstrap charging prior to switching start, asserting the reset input low enables weak pulldown of the half-bridge outputs. In the SE mode, the output is forced into a high impedance state when asserting the reset input low. Asserting reset input low removes any fault information to be signaled on the \overline{SD} output, i.e., \overline{SD} is forced high. A rising-edge transition on reset input allows the device to resume operation after an overload fault. To ensure thermal reliability, the rising edge of reset must occur no sooner than 4 ms after the falling edge of \overline{SD} .

SYSTEM DESIGN CONSIDERATION

A rising-edge transition on reset input allows the device to execute the startup sequence and starts switching.

Apply only audio when the state of READY is high that will start and stop the amplifier without having audible artifacts that is heard in the output transducers. If an overcurrent protection event is introduced the READY signal goes low, hence, filtering is needed if the signal is intended for audio muting in non micro controller systems.

The CLIP signal is indicating that the output is approaching clipping. The signal can be used to either an audio volume decrease or intelligent power supply controlling a low and a high rail.

The device is inverting the audio signal from input to output.

The VREG pin is not recommended to be used as a voltage source for external circuitry.

PRINTED CIRCUIT BOARD RECOMMENDATION

Use an unbroken ground plane to have good low impedance and inductance return path to the power supply for power and audio signals. PCB layout, audio performance and EMI are linked closely together. The circuit contains high fast switching currents; therefore, care must be taken to prevent damaging voltage spikes. Routing the audio input should be kept short and together with the accompanied audio source ground. A local ground area underneath the device is important to keep solid to minimize ground bounce.

Netlist for this printed circuit board is generated from the schematic in [Figure 12](#).

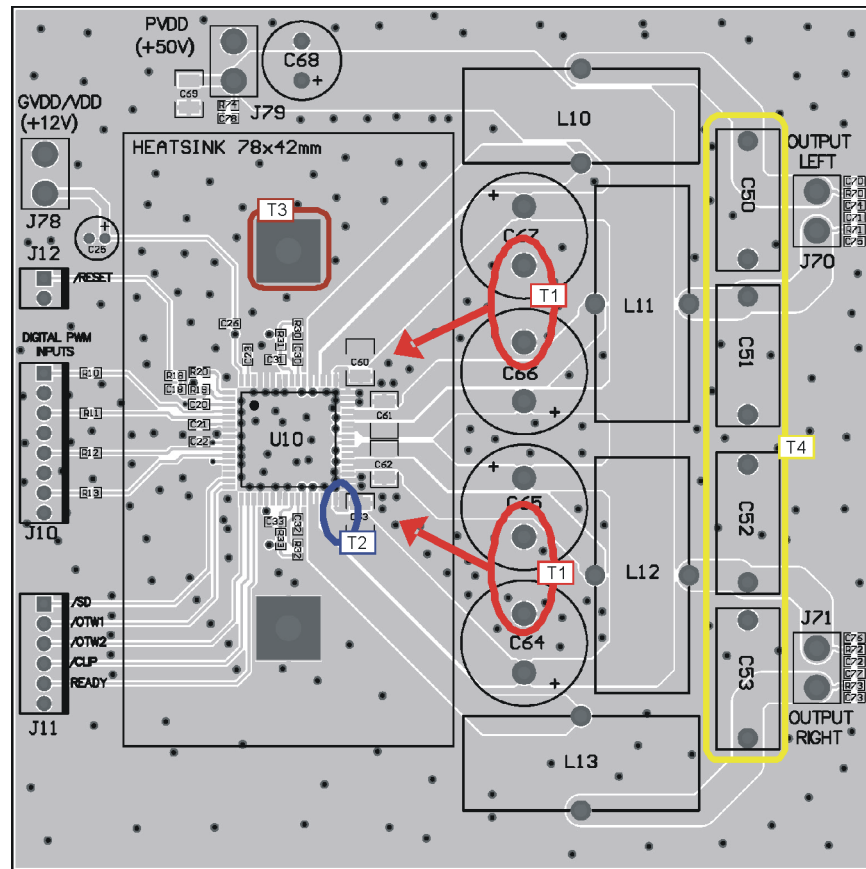

Note T1: PVDD decoupling bulk capacitors C60-C64 should be as close as possible to the PVDD and GND_X pins, the heat sink sets the distance. Wide traces should be routed on the top layer with direct connection to the pins and without going through vias. No vias or traces should be blocking the current path.

Note T2: Close decoupling of PVDD with low impedance X7R ceramic capacitors is placed under the heat sink and close to the pins.

Note T3: Heat sink needs to have a good connection to PCB ground.

Note T4: Output filter capacitors must be linear in the applied voltage range preferable metal film types.

Figure 14. Printed Circuit Board - Top Layer

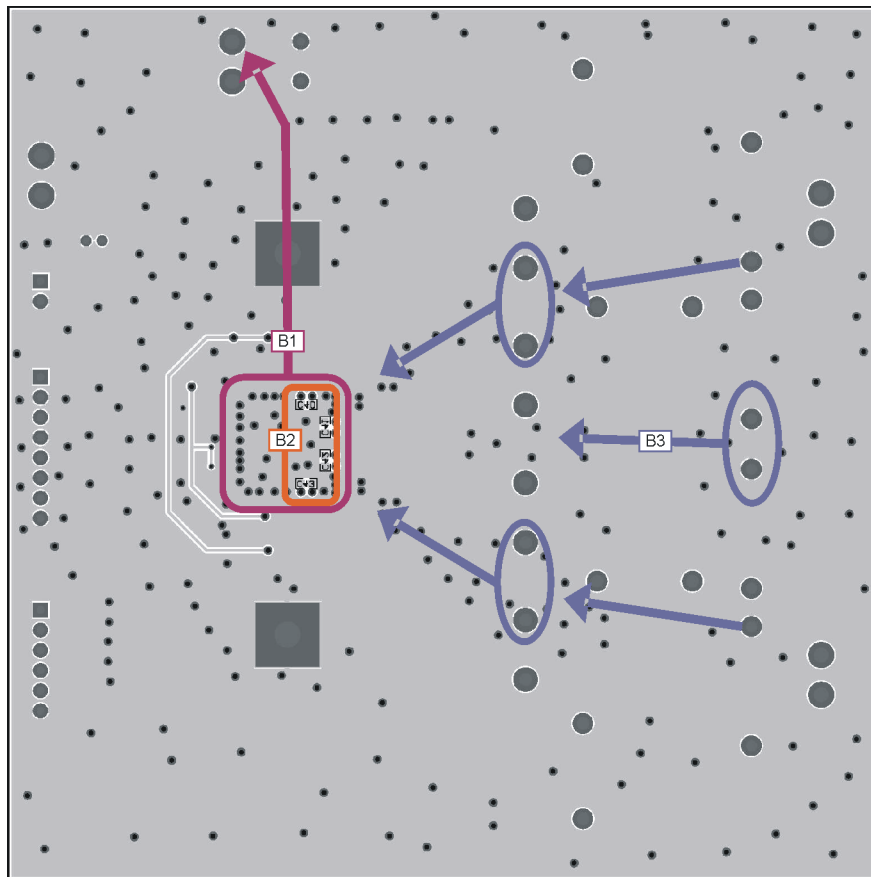

Note B1: It is important to have a direct low impedance return path for high current back to the power supply. Keep impedance low from top to bottom side of PCB through a lot of ground vias.

Note B2: Bootstrap low impedance X7R ceramic capacitors placed on bottom side providing a short low inductance current loop.

Note B3: Return currents from bulk capacitors and output filter capacitors.

Figure 15. Printed Circuit Board - Bottom Layer

REVISION HISTORY

Note: Page numbers of current version may differ from previous versions.

Changes from Original (June 2010) to Revision A	Page
• Deleted DKD (44-Pin PSOP3 from the Features	1
• Changed "Both package types" to "The package type" in paragraph under Terminal Assignment and deleted the DKD PACKAGE drawing	2
• Deleted the TAS5612ADKD column in the PACKAGE HEAT DISSIPATION RATINGS table	3
• Deleted the TAS5612ADKD row in the ORDERING INFORMATION table	3
• Changed the Junction temperature in the ROC table in the MAX column from 150 to 125	4
• Deleted the DKD NO. column from the PIN FUNCTIONS table	5
• Deleted figure showing BTL application with BD modulation filters for the DKD device from SYSTEM DESIGN RECOMMENDATIONS section	14
Changes from Revision A (March 2011) to Revision B	
• Changed the AUDIO CHARAC (BTL) table $ V_{OS} $ row, TYP column from 20 to 5 mV and MAX column from 30 to 18 mV	8
• Changed V_{UVP} , G spec (first row under I/O PROTECTION in ELEC CHARA table) from "Undervoltage.....GVDD_x" to "Undervoltage.....GVDD_x, VDD" and the TYP column from "10" to "9.5" V	9

PACKAGING INFORMATION

Orderable Device	Status (1)	Package Type	Package Drawing	Pins	Package Qty	Eco Plan (2)	Lead/Ball Finish	MSL Peak Temp (3)	Op Temp (°C)	Top-Side Markings (4)	Samples
TAS5612APHD	ACTIVE	HTQFP	PHD	64	90	Green (RoHS & no Sb/Br)	CU NIPDAU	Level-3-260C-168 HR	0 to 70	TAS5612A	Samples
TAS5612APHDR	ACTIVE	HTQFP	PHD	64	1000	Green (RoHS & no Sb/Br)	CU NIPDAU	Level-3-260C-168 HR	0 to 70	TAS5612A	Samples

(1) The marketing status values are defined as follows:

ACTIVE: Product device recommended for new designs.

LIFEBUY: TI has announced that the device will be discontinued, and a lifetime-buy period is in effect.

NRND: Not recommended for new designs. Device is in production to support existing customers, but TI does not recommend using this part in a new design.

PREVIEW: Device has been announced but is not in production. Samples may or may not be available.

OBSOLETE: TI has discontinued the production of the device.

(2) Eco Plan - The planned eco-friendly classification: Pb-Free (RoHS), Pb-Free (RoHS Exempt), or Green (RoHS & no Sb/Br) - please check <http://www.ti.com/productcontent> for the latest availability information and additional product content details.

TBD: The Pb-Free/Green conversion plan has not been defined.

Pb-Free (RoHS): TI's terms "Lead-Free" or "Pb-Free" mean semiconductor products that are compatible with the current RoHS requirements for all 6 substances, including the requirement that lead not exceed 0.1% by weight in homogeneous materials. Where designed to be soldered at high temperatures, TI Pb-Free products are suitable for use in specified lead-free processes.

Pb-Free (RoHS Exempt): This component has a RoHS exemption for either 1) lead-based flip-chip solder bumps used between the die and package, or 2) lead-based die adhesive used between the die and leadframe. The component is otherwise considered Pb-Free (RoHS compatible) as defined above.

Green (RoHS & no Sb/Br): TI defines "Green" to mean Pb-Free (RoHS compatible), and free of Bromine (Br) and Antimony (Sb) based flame retardants (Br or Sb do not exceed 0.1% by weight in homogeneous material)

(3) MSL, Peak Temp. -- The Moisture Sensitivity Level rating according to the JEDEC industry standard classifications, and peak solder temperature.

(4) Multiple Top-Side Markings will be inside parentheses. Only one Top-Side Marking contained in parentheses and separated by a "~" will appear on a device. If a line is indented then it is a continuation of the previous line and the two combined represent the entire Top-Side Marking for that device.

Important Information and Disclaimer: The information provided on this page represents TI's knowledge and belief as of the date that it is provided. TI bases its knowledge and belief on information provided by third parties, and makes no representation or warranty as to the accuracy of such information. Efforts are underway to better integrate information from third parties. TI has taken and continues to take reasonable steps to provide representative and accurate information but may not have conducted destructive testing or chemical analysis on incoming materials and chemicals. TI and TI suppliers consider certain information to be proprietary, and thus CAS numbers and other limited information may not be available for release.

In no event shall TI's liability arising out of such information exceed the total purchase price of the TI part(s) at issue in this document sold by TI to Customer on an annual basis.

TAPE AND REEL INFORMATION



QUADRANT ASSIGNMENTS FOR PIN 1 ORIENTATION IN TAPE



*All dimensions are nominal

Device	Package Type	Package Drawing	Pins	SPQ	Reel Diameter (mm)	Reel Width W1 (mm)	A0 (mm)	B0 (mm)	K0 (mm)	P1 (mm)	W (mm)	Pin1 Quadrant
TAS5612APHDR	HTQFP	PHD	64	1000	330.0	24.4	17.0	17.0	1.5	20.0	24.0	Q2

TAPE AND REEL BOX DIMENSIONS

*All dimensions are nominal

Device	Package Type	Package Drawing	Pins	SPQ	Length (mm)	Width (mm)	Height (mm)
TAS5612APHDR	HTQFP	PHD	64	1000	367.0	367.0	45.0

MECHANICAL DATA

PHD (S-PQFP-G64) PowerPAD™ PLASTIC QUAD FLATPACK (DIE DOWN)

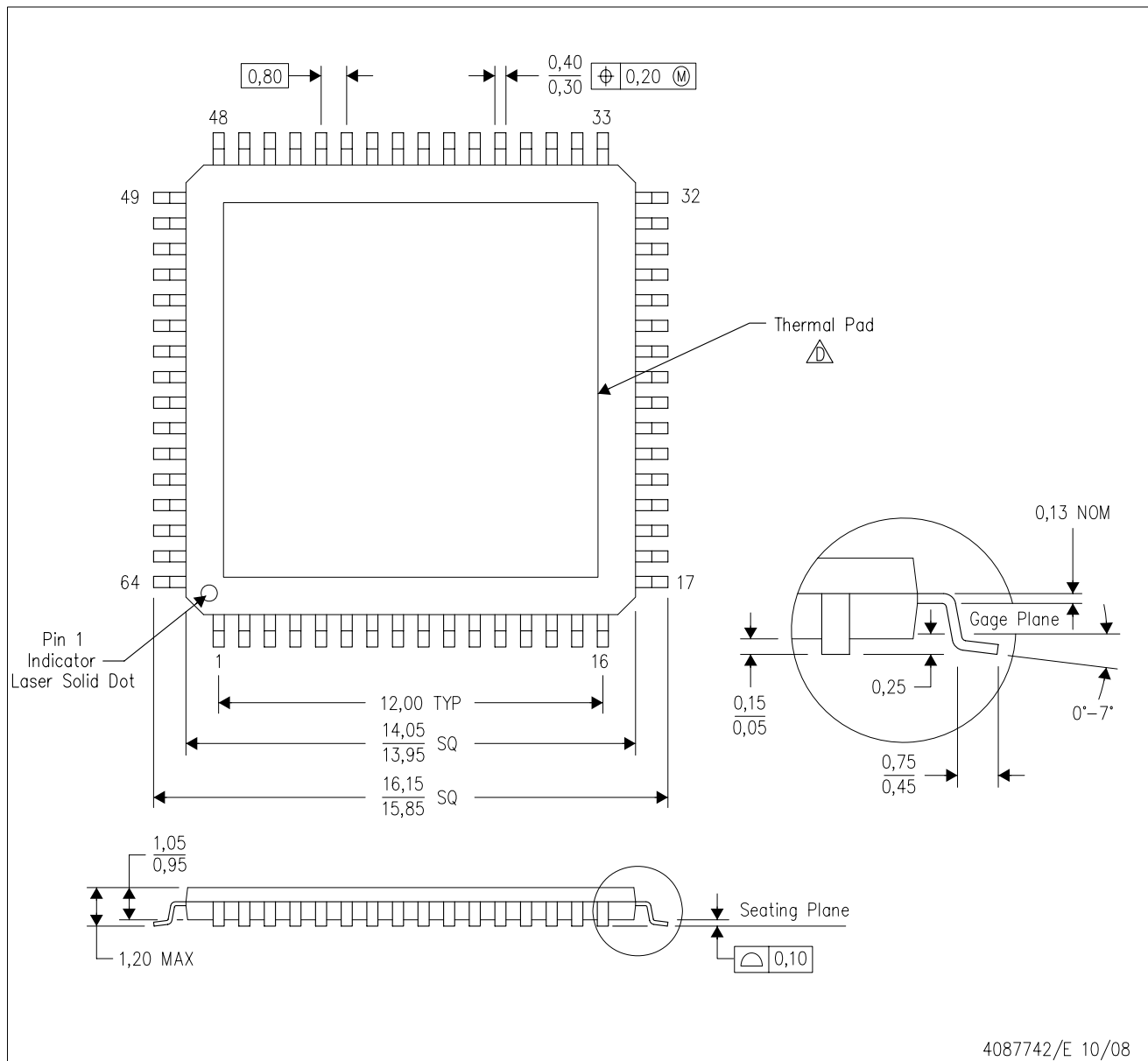

- NOTES:
- A. All linear dimensions are in millimeters. Dimensioning and tolerancing per ASME Y14.5M-1994.
 - B. This drawing is subject to change without notice.
 - C. Body dimensions do not include mold flash or protrusion
 - △ This package is designed to be attached directly to an external heatsink. Refer to Technical Brief, PowerPad Thermally Enhanced Package, Texas Instruments Literature No. SLMA002 for information regarding recommended board layout. This document is available at www.ti.com <<http://www.ti.com>>. See the product data sheet for details regarding the exposed thermal pad dimensions.
 - E. Falls within JEDEC MS-026

PowerPAD is a trademark of Texas Instruments.

THERMAL PAD MECHANICAL DATA

PHD (S-PQFP-G64) PowerPAD™ PLASTIC QUAD FLATPACK (DIE DOWN)

THERMAL INFORMATION

This PowerPAD™ package incorporates an exposed thermal pad that is designed to be attached directly to an external heatsink. This design optimizes the heat transfer from the integrated circuit (IC).

For additional information on the PowerPAD package and how to take advantage of its heat dissipating abilities, refer to Technical Brief, PowerPAD Thermally Enhanced Package, Texas Instruments Literature No. SLMA002 and Application Brief, PowerPAD Made Easy, Texas Instruments Literature No. SLMA004. Both documents are available at www.ti.com.

The exposed thermal pad dimensions for this package are shown in the following illustration.

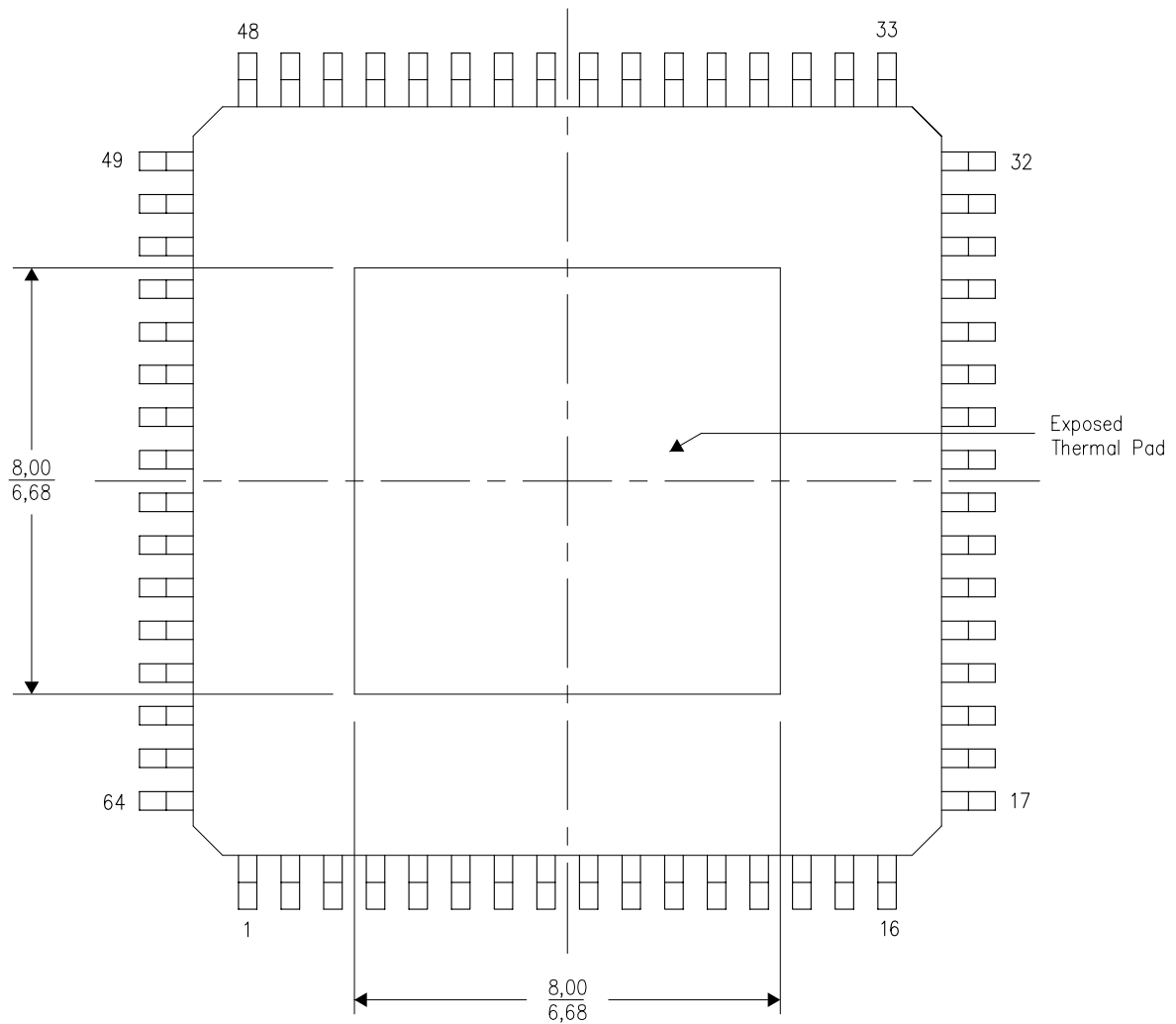

Top View

Exposed Thermal Pad Dimensions

4206328-3/H 04/11

NOTE: A. All linear dimensions are in millimeters

PowerPAD is a trademark of Texas Instruments

IMPORTANT NOTICE

Texas Instruments Incorporated and its subsidiaries (TI) reserve the right to make corrections, enhancements, improvements and other changes to its semiconductor products and services per JESD46, latest issue, and to discontinue any product or service per JESD48, latest issue. Buyers should obtain the latest relevant information before placing orders and should verify that such information is current and complete. All semiconductor products (also referred to herein as "components") are sold subject to TI's terms and conditions of sale supplied at the time of order acknowledgment.

TI warrants performance of its components to the specifications applicable at the time of sale, in accordance with the warranty in TI's terms and conditions of sale of semiconductor products. Testing and other quality control techniques are used to the extent TI deems necessary to support this warranty. Except where mandated by applicable law, testing of all parameters of each component is not necessarily performed.

TI assumes no liability for applications assistance or the design of Buyers' products. Buyers are responsible for their products and applications using TI components. To minimize the risks associated with Buyers' products and applications, Buyers should provide adequate design and operating safeguards.

TI does not warrant or represent that any license, either express or implied, is granted under any patent right, copyright, mask work right, or other intellectual property right relating to any combination, machine, or process in which TI components or services are used. Information published by TI regarding third-party products or services does not constitute a license to use such products or services or a warranty or endorsement thereof. Use of such information may require a license from a third party under the patents or other intellectual property of the third party, or a license from TI under the patents or other intellectual property of TI.

Reproduction of significant portions of TI information in TI data books or data sheets is permissible only if reproduction is without alteration and is accompanied by all associated warranties, conditions, limitations, and notices. TI is not responsible or liable for such altered documentation. Information of third parties may be subject to additional restrictions.

Resale of TI components or services with statements different from or beyond the parameters stated by TI for that component or service voids all express and any implied warranties for the associated TI component or service and is an unfair and deceptive business practice. TI is not responsible or liable for any such statements.

Buyer acknowledges and agrees that it is solely responsible for compliance with all legal, regulatory and safety-related requirements concerning its products, and any use of TI components in its applications, notwithstanding any applications-related information or support that may be provided by TI. Buyer represents and agrees that it has all the necessary expertise to create and implement safeguards which anticipate dangerous consequences of failures, monitor failures and their consequences, lessen the likelihood of failures that might cause harm and take appropriate remedial actions. Buyer will fully indemnify TI and its representatives against any damages arising out of the use of any TI components in safety-critical applications.

In some cases, TI components may be promoted specifically to facilitate safety-related applications. With such components, TI's goal is to help enable customers to design and create their own end-product solutions that meet applicable functional safety standards and requirements. Nonetheless, such components are subject to these terms.

No TI components are authorized for use in FDA Class III (or similar life-critical medical equipment) unless authorized officers of the parties have executed a special agreement specifically governing such use.

Only those TI components which TI has specifically designated as military grade or "enhanced plastic" are designed and intended for use in military/aerospace applications or environments. Buyer acknowledges and agrees that any military or aerospace use of TI components which have **not** been so designated is solely at the Buyer's risk, and that Buyer is solely responsible for compliance with all legal and regulatory requirements in connection with such use.

TI has specifically designated certain components as meeting ISO/TS16949 requirements, mainly for automotive use. In any case of use of non-designated products, TI will not be responsible for any failure to meet ISO/TS16949.

Products

Audio	www.ti.com/audio
Amplifiers	amplifier.ti.com
Data Converters	dataconverter.ti.com
DLP® Products	www.dlp.com
DSP	dsp.ti.com
Clocks and Timers	www.ti.com/clocks
Interface	interface.ti.com
Logic	logic.ti.com
Power Mgmt	power.ti.com
Microcontrollers	microcontroller.ti.com
RFID	www.ti-rfid.com
OMAP Applications Processors	www.ti.com/omap
Wireless Connectivity	www.ti.com/wirelessconnectivity

Applications

Automotive and Transportation	www.ti.com/automotive
Communications and Telecom	www.ti.com/communications
Computers and Peripherals	www.ti.com/computers
Consumer Electronics	www.ti.com/consumer-apps
Energy and Lighting	www.ti.com/energy
Industrial	www.ti.com/industrial
Medical	www.ti.com/medical
Security	www.ti.com/security
Space, Avionics and Defense	www.ti.com/space-avionics-defense
Video and Imaging	www.ti.com/video

TI E2E Community

e2e.ti.com