

## Transmissive Optical Sensor with Phototransistor Output



19180\_4



19180\_3

### DESCRIPTION

The TCST2103, TCST2202, and TCST2300 are transmissive sensors that include an infrared emitter and phototransistor, located face-to-face on the optical axes in a leaded package which blocks visible light. These part numbers include options for aperture width.

### FEATURES

- Package type: leaded
- Detector type: phototransistor
- Dimensions (L x W x H in mm): 24.5 x 6.3 x 10.8
- Gap (in mm): 3.1
- Typical output current under test:  $I_C = 4$  mA (TCST2103)
- Typical output current under test:  $I_C = 2$  mA (TCST2202)
- Typical output current under test:  $I_C = 0.5$  mA (TCST2300)
- Daylight blocking filter
- Emitter wavelength: 950 nm
- Lead (Pb)-free soldering released
- Compliant to RoHS directive 2002/95/EC and in accordance to WEEE 2002/96/EC



**RoHS**  
COMPLIANT

### APPLICATIONS

- Optical switch
- Photo interrupter
- Counter
- Encoder

### PRODUCT SUMMARY

PART NUMBER	GAP WIDTH (mm)	APERTURE WIDTH (mm)	TYPICAL OUTPUT CURRENT UNDER TEST <sup>(1)</sup> (mA)	DAYLIGHT BLOCKING FILTER INTEGRATED
TCST2103	3.1	1	4	Yes
TCST2202	3.1	0.5	2	Yes
TCST2300	3.1	0.25	0.5	Yes

**Note**

<sup>(1)</sup> Conditions like in table basic characteristics/coupler

### ORDERING INFORMATION

ORDERING CODE	PACKAGING	VOLUME <sup>(1)</sup>	REMARKS
TCST2103	Tube	MOQ: 1020 pcs, 85 pcs/tube	With mounting flange
TCST2202	Tube	MOQ: 1020 pcs, 85 pcs/tube	With mounting flange
TCST2300	Tube	MOQ: 1020 pcs, 85 pcs/tube	With mounting flange

**Note**

<sup>(1)</sup> MOQ: minimum order quantity

### ABSOLUTE MAXIMUM RATINGS <sup>(1)</sup>

PARAMETER	TEST CONDITION	SYMBOL	VALUE	UNIT
<b>COUPLER</b>				
Total power dissipation	$T_{amb} \leq 25$ °C	$P_{tot}$	250	mW
Ambient temperature range		$T_{amb}$	- 55 to + 85	°C
Storage temperature range		$T_{stg}$	- 55 to + 100	°C
Soldering temperature	Distance to package: 2 mm; $t \leq 5$ s	$T_{sd}$	260	°C

ABSOLUTE MAXIMUM RATINGS (1)				
PARAMETER	TEST CONDITION	SYMBOL	VALUE	UNIT
<b>INPUT (EMITTER)</b>				
Reverse voltage		$V_R$	6	V
Forward current		$I_F$	60	mA
Forward surge current	$t_p \leq 10 \mu s$	$I_{FSM}$	3	A
Power dissipation	$T_{amb} \leq 25 \text{ }^\circ\text{C}$	$P_V$	100	mW
Junction temperature		$T_j$	100	$^\circ\text{C}$
<b>OUTPUT (DETECTOR)</b>				
Collector emitter voltage		$V_{CEO}$	70	V
Emitter collector voltage		$V_{ECO}$	7	V
Collector peak current	$t_p/T = 0.5, t_p \leq 10 \text{ ms}$	$I_{CM}$	200	mA
Power dissipation	$T_{amb} \leq 25 \text{ }^\circ\text{C}$	$P_V$	150	mW
Junction temperature		$T_j$	100	$^\circ\text{C}$

**Note**

(1)  $T_{amb} = 25 \text{ }^\circ\text{C}$ , unless otherwise specified

**ABSOLUTE MAXIMUM RATINGS**



Fig. 1 - Power Dissipation Limit vs. Ambient Temperature

BASIC CHARACTERISTICS (1)							
PARAMETER	TEST CONDITION	PART	SYMBOL	MIN.	TYP.	MAX.	UNIT
<b>COUPLER</b>							
Current transfer ratio	$V_{CE} = 5 \text{ V}, I_F = 20 \text{ mA}$	TCST2103	CTR	10	20		%
		TCST2202	CTR	5	10		%
		TCST2300	CTR	1.25	2.5		%
Collector current	$V_{CE} = 5 \text{ V}, I_F = 20 \text{ mA}$	TCST2103	$I_C$	2	4		mA
		TCST2202	$I_C$	1	2		mA
		TCST2300	$I_C$	0.25	0.5		mA
Collector emitter saturation voltage	$I_F = 20 \text{ mA}, I_C = 1 \text{ mA}$	TCST2103	$V_{CEsat}$			0.4	V
	$I_F = 20 \text{ mA}, I_C = 0.5 \text{ mA}$	TCST2202	$V_{CEsat}$			0.4	V
	$I_F = 20 \text{ mA}, I_C = 0.1 \text{ mA}$	TCST2300	$V_{CEsat}$			0.4	V
Resolution, path of the shutter crossing the radiant sensitive zone	$I_{Crel} = 10 \text{ } \% \text{ to } 90 \text{ } \%$	TCST2103	s		0.6		mm
		TCST2202	s		0.4		mm
		TCST2300	s		0.2		mm

BASIC CHARACTERISTICS (1)							
PARAMETER	TEST CONDITION	PART	SYMBOL	MIN.	TYP.	MAX.	UNIT
<b>INPUT (EMITTER)</b>							
Forward voltage	$I_F = 60 \text{ mA}$		$V_F$		1.25	1.6	V
Junction capacitance	$V_R = 0 \text{ V}, f = 1 \text{ MHz}$		$C_j$		50		pF
<b>OUTPUT (DETECTOR)</b>							
Collector emitter voltage	$I_C = 1 \text{ mA}$		$V_{CEO}$	70			V
Emitter collector voltage	$I_E = 10 \mu\text{A}$		$V_{ECO}$	7			V
Collector dark current	$V_{CE} = 25 \text{ V}, I_F = 0 \text{ A}, E = 0 \text{ lx}$		$I_{CEO}$			100	nA
<b>SWITCHING CHARACTERISTICS</b>							
Turn-on time	$I_C = 2 \text{ mA}, V_S = 5 \text{ V}, R_L = 100 \Omega$ (see figure 2)		$t_{on}$		10		$\mu\text{s}$
Turn-off time	$I_C = 2 \text{ mA}, V_S = 5 \text{ V}, R_L = 100 \Omega$ (see figure 2)		$t_{off}$		8		$\mu\text{s}$

**Note**

(1)  $T_{amb} = 25 \text{ }^\circ\text{C}$ , unless otherwise specified



Fig. 2 - Test Circuit for  $t_{on}$  and  $t_{off}$



Fig. 3 - Switching Times

**BASIC CHARACTERISTICS**

$T_{amb} = 25 \text{ }^\circ\text{C}$ , unless otherwise specified

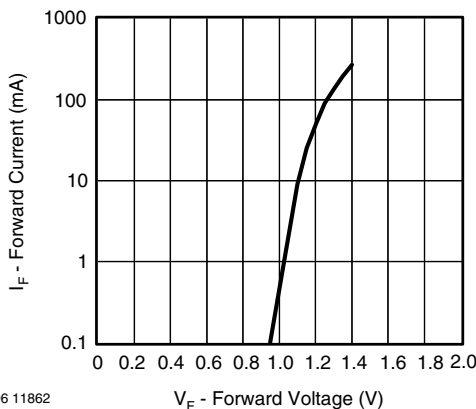

Fig. 4 - Forward Current vs. Forward Voltage

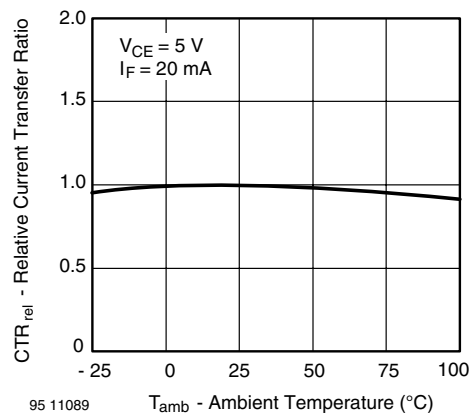

Fig. 5 - Relative Current Transfer Ratio vs. Ambient Temperature

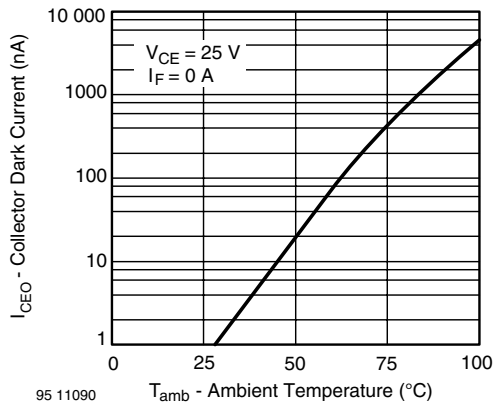

Fig. 6 - Collector Dark Current vs. Ambient Temperature

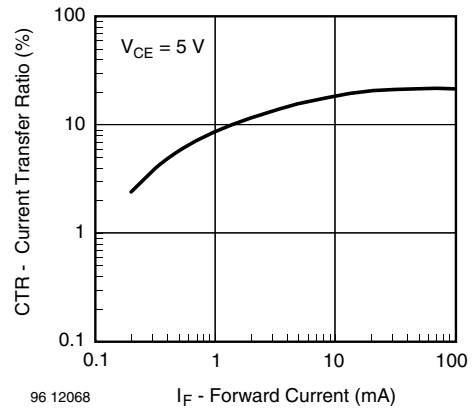

Fig. 9 - Current Transfer Ratio vs. Forward Current

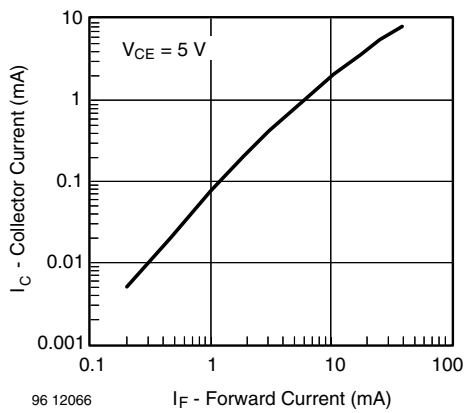

Fig. 7 - Collector Current vs. Forward Current

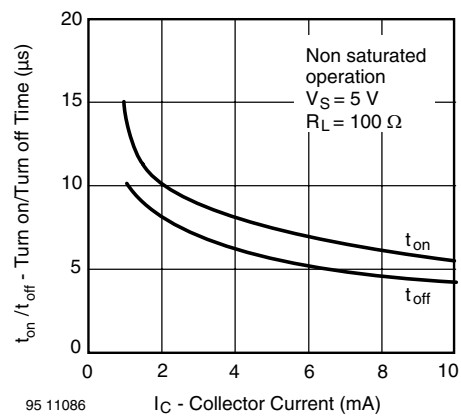

Fig. 10 - Turn-off/Turn-on Time vs. Collector Current



Fig. 8 - Collector Current vs. Collector Emitter Voltage

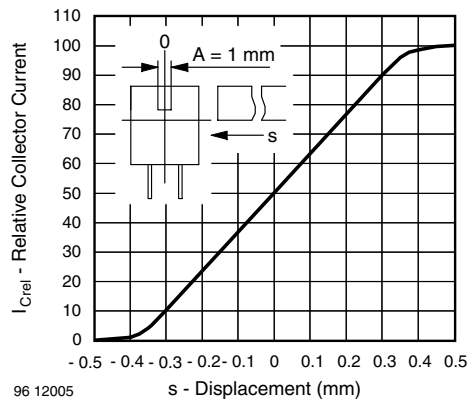

Fig. 11 - Relative Collector Current vs. Displacement

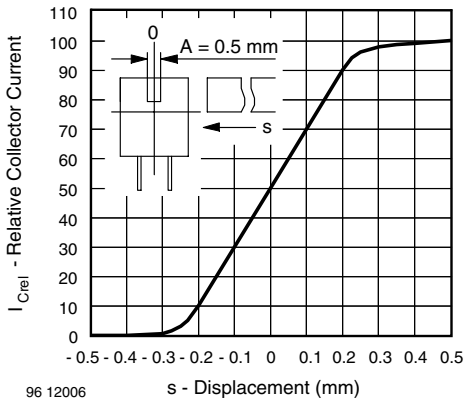

Fig. 12 - Relative Collector Current vs. Displacement

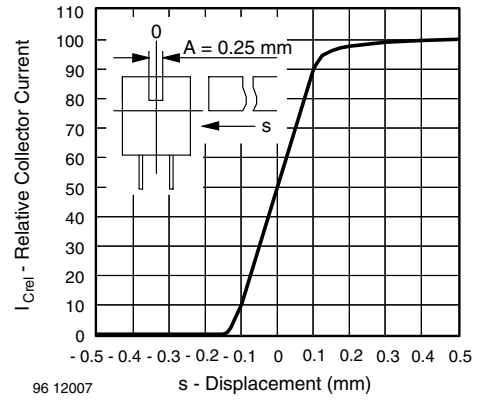
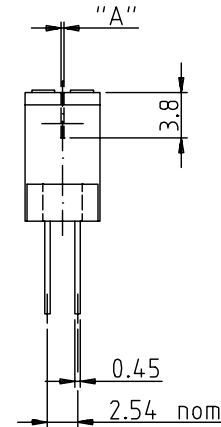

Fig. 13 - Relative Collector Current vs. Displacement

### PACKAGE DIMENSIONS in millimeters



technical drawings according to DIN specifications

weight: ca. 0.90g

Drawing-No.: 6.550-5040.01-4  
 Issue: 2; 10.11.98  
 96 12095

# TCST2103, TCST2202, TCST2300



Vishay Semiconductors Transmissive Optical Sensor with Phototransistor Output

## TUBE DIMENSIONS in millimeters

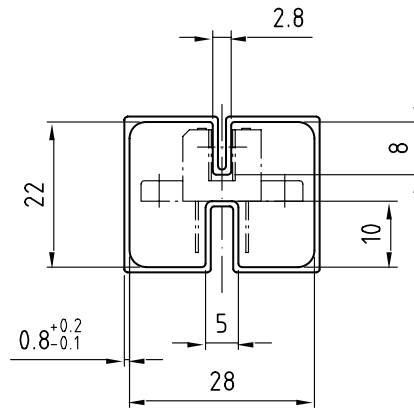

With rubber stopper  
Tolerance:  $\pm 0.5\text{mm}$   
Length:  $575 \pm 1\text{mm}$

Drawing-No.: 9.700-5100.01-4  
Issue: 1; 25.02.00  
20252

## Packaging and Ordering Information

PART NUMBER	MOQ <sup>(1)</sup>	PCS PER TUBE	TUBE SPEC. (FIGURE)	CONSTITUENTS (FORMS)
CNY70	4000	80	1	28
TCPT1300X01	2000	Reel	(2)	29
TCRT1000	1000	Bulk	-	26
TCRT1010	1000	Bulk	-	26
TCRT5000	4500	50	2	27
TCRT5000L	2400	48	3	27
TCST1030	5200	65	5	24
TCST1030L	2600	65	6	24
TCST1103	1020	85	4	24
TCST1202	1020	85	4	24
TCST1230	4800	60	7	24
TCST1300	1020	85	4	24
TCST2103	1020	85	4	24
TCST2202	1020	85	4	24
TCST2300	1020	85	4	24
TCST5250	4860	30	8	24
TCUT1300X01	2000	Reel	(2)	29
TCZT8020-PAER	2500	Bulk	-	22

### Notes

- (1) MOQ: minimum order quantity
- (2) Please refer to datasheets

### TUBE SPECIFICATION FIGURES



With rubber stopper

Tolerance: ±0.5mm

Length: 575±1mm

Drawing-No.: 9.700-5097.01-4  
Issue: 1; 25.02.00

15198

Fig. 1

# Packaging and Ordering Information

Vishay Semiconductors Packaging and Ordering Information



Drawing-No.: 9.700-5139.01-4  
Issue: 1; 10.05.00

Drawing refers to following types: TCRT 5000

15210

Fig. 2



With stopper pins  
Tolerance: ±0.5mm  
Length: 575±1mm

Drawing-No.: 9.700-5178.01-4  
Issue: 1; 25.02.00

15201

Fig. 3





With rubber stopper  
Tolerance:  $\pm 0.5\text{mm}$   
Length:  $575 \pm 1\text{mm}$

Drawing-No.: 9.700-5100.01-4  
Issue: 1; 25.02.00

15199

Fig. 4



With stopper pins  
Tolerance:  $\pm 0.5\text{mm}$   
Length:  $575 \pm 1\text{mm}$

Drawing-No.: 9.700-5140.01-4  
Issue: 1; 25.02.00

15202

Fig. 5

# Packaging and Ordering Information

Vishay Semiconductors Packaging and Ordering Information



Drawing-No.: 9.700-5205.01-4  
Issue: 1; 25.02.00

15196

Fig. 6



Drawing-No.: 9.700-5245.01-4  
Issue: 1; 25.02.00

15195

Fig. 7



Drawing-No.: 9.700-5222.01-4  
 Issue: 2; 19.11.04  
 20257

With stopper pins  
 Tolerance:  $\pm 0.5\text{mm}$   
 Length:  $450 \pm 1\text{mm}$   
 All dimensions in mm

Fig. 8



## Disclaimer

ALL PRODUCT, PRODUCT SPECIFICATIONS AND DATA ARE SUBJECT TO CHANGE WITHOUT NOTICE TO IMPROVE RELIABILITY, FUNCTION OR DESIGN OR OTHERWISE.

Vishay Intertechnology, Inc., its affiliates, agents, and employees, and all persons acting on its or their behalf (collectively, "Vishay"), disclaim any and all liability for any errors, inaccuracies or incompleteness contained in any datasheet or in any other disclosure relating to any product.

Vishay makes no warranty, representation or guarantee regarding the suitability of the products for any particular purpose or the continuing production of any product. To the maximum extent permitted by applicable law, Vishay disclaims (i) any and all liability arising out of the application or use of any product, (ii) any and all liability, including without limitation special, consequential or incidental damages, and (iii) any and all implied warranties, including warranties of fitness for particular purpose, non-infringement and merchantability.

Statements regarding the suitability of products for certain types of applications are based on Vishay's knowledge of typical requirements that are often placed on Vishay products in generic applications. Such statements are not binding statements about the suitability of products for a particular application. It is the customer's responsibility to validate that a particular product with the properties described in the product specification is suitable for use in a particular application. Parameters provided in datasheets and / or specifications may vary in different applications and performance may vary over time. All operating parameters, including typical parameters, must be validated for each customer application by the customer's technical experts. Product specifications do not expand or otherwise modify Vishay's terms and conditions of purchase, including but not limited to the warranty expressed therein.

Hyperlinks included in this datasheet may direct users to third-party websites. These links are provided as a convenience and for informational purposes only. Inclusion of these hyperlinks does not constitute an endorsement or an approval by Vishay of any of the products, services or opinions of the corporation, organization or individual associated with the third-party website. Vishay disclaims any and all liability and bears no responsibility for the accuracy, legality or content of the third-party website or for that of subsequent links.

Except as expressly indicated in writing, Vishay products are not designed for use in medical, life-saving, or life-sustaining applications or for any other application in which the failure of the Vishay product could result in personal injury or death. Customers using or selling Vishay products not expressly indicated for use in such applications do so at their own risk. Please contact authorized Vishay personnel to obtain written terms and conditions regarding products designed for such applications.

No license, express or implied, by estoppel or otherwise, to any intellectual property rights is granted by this document or by any conduct of Vishay. Product names and markings noted herein may be trademarks of their respective owners.