

3-Channel ED Filter Video Amplifier with 4-V/V Gain

Check for Samples: [THS7320](#)

FEATURES

- **Very Low Total Quiescent Current:**
3.5 mA at 3 V
- **Disabled Supply Current:** 0.15 μ A
- **Third-Order Butterworth Low-Pass Filters:**
 - –1 dB at 17 MHz
 - –3 dB at 20 MHz
 - Attenuation: 21 dB at 43 MHz
 - Supports Y'P'B'R 480p/576p or R'G'B' Video
 - Supports Oversampled Systems Generating CVBS, S-Video, or Y'P'B'R 480i/576i
- **DC-Coupled Input with 150-mV Output Shift**
- **Built-In Gain:** 4 V/V (12 dB)
- **Single-Supply Operation:** +2.6 V to +5 V
- **Rail-to-Rail Output Supports AC- or DC-Coupling**
- **Low Differential Gain/Phase:** 0.1%/0.1°
- **Output Pins Support \pm 8-kV IEC ESD Protection**
- **Ultra Small, WCSP 9-Ball Package:**
 - Tiny PCB Area: 0.96 mm x 0.96 mm (Typ)
 - Very Low Profile Height: 0.5 mm (Max)
 - Pitch: 0.3 mm

DESCRIPTION

Fabricated using the revolutionary, complementary Silicon-Germanium (SiGe) BiCom-3X process, the THS7320 is a very low power, single-supply, 2.6-V to 5-V, three-channel integrated video buffer with a gain of 4 V/V. This device is ideal for battery-powered applications where size and power are critical parameters. The total quiescent current is only 3.5 mA at 3 V and the video portion can be reduced down to 0.15 μ A while disabled.

The THS7320 video section incorporates three enhanced definition (ED) filter channels with third-order Butterworth characteristics. These filters are useful as digital-to-analog converter (DAC) reconstruction filters or as analog-to-digital converter (ADC) antialiasing filters. The THS7320 is also ideal for oversampled systems that produce standard definition (SD) signals including CVBS, S-Video, 480i/576i Y'P'B'R, Y'U'V', and R'G'B'.

The THS7320 is designed for dc-coupled inputs. To mitigate any DAC/encoder termination interaction, the input impedance is a very high 2.4 M Ω . The internal level shift adds 150-mV offset at the output to eliminate saturation or clipping concerns. The rail-to-rail output supports either dc- or ac-coupling.

The THS7320 is available in an ultra small, 9-ball wafer chip-scale package (WCSP) package that requires an ultra small, 0.92-mm² (typ) printed circuit board (PCB) area.

APPLICATIONS

- **Personal Media Players**
- **Digital Cameras**
- **Cellular Phone Video Output Buffering**

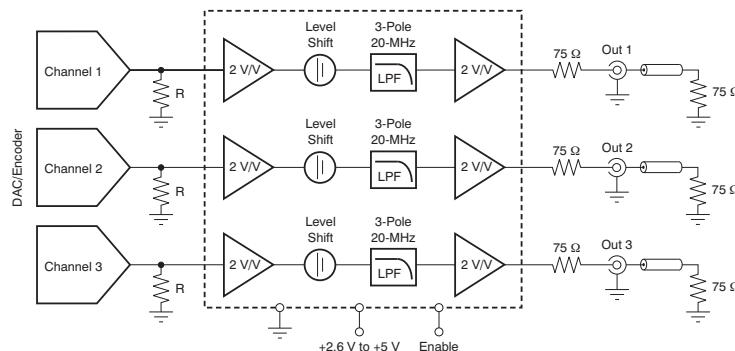

Simplified Application Circuit



Please be aware that an important notice concerning availability, standard warranty, and use in critical applications of Texas Instruments semiconductor products and disclaimers thereto appears at the end of this data sheet.

All trademarks are the property of their respective owners.



This integrated circuit can be damaged by ESD. Texas Instruments recommends that all integrated circuits be handled with appropriate precautions. Failure to observe proper handling and installation procedures can cause damage.

ESD damage can range from subtle performance degradation to complete device failure. Precision integrated circuits may be more susceptible to damage because very small parametric changes could cause the device not to meet its published specifications.

PACKAGE/ORDERING INFORMATION⁽¹⁾

| PACKAGED DEVICES | PACKAGE TYPE | PACKAGE MARKING | TRANSPORT MEDIA, QUANTITY | ECO STATUS ⁽²⁾ |
|------------------|---------------------|-----------------|---------------------------|---------------------------|
| THS7320IYHCR | DSBGA (9-Ball WCSP) | QJK | Tape and Reel, 3000 | Pb-Free, Green |
| THS7320IYHCT | DSBGA (9-Ball WCSP) | QJK | Tape and Reel, 250 | Pb-Free, Green |

- (1) For the most current package and ordering information, see the Package Option Addendum at the end of this document, or visit the device product folder at www.ti.com.
- (2) Eco-Status information. Additional details including specific material content can be accessed at www.ti.com/leadfree.
 GREEN: TI defines Green to mean Lead (Pb)-Free and in addition, uses less package materials that do not contain halogens, including bromine (Br), or antimony (Sb) above 0.1% of total product weight. N/A: Not yet available Lead (Pb)-Free; for estimated conversion dates, go to www.ti.com/leadfree.
 Pb-FREE: TI defines Lead (Pb)-Free to mean RoHS compatible, including a lead concentration that does not exceed 0.1% of total product weight, and, if designed to be soldered, suitable for use in specified lead-free soldering processes.

ABSOLUTE MAXIMUM RATINGS⁽¹⁾

Over operating free-air temperature range, unless otherwise noted.

| | VALUE | UNIT |
|--|---------------------------------|------|
| Supply voltage, V_{S+} to GND | –0.4 to +5.5 | V |
| Video input voltage, video enable pin | –0.4 to $V_{S+} + 0.4$ | V |
| Output current, I_O | ±75 | mA |
| Continuous power dissipation | See Thermal Information table | |
| Maximum junction temperature, any condition ⁽²⁾ , T_J | +150 | °C |
| Maximum junction temperature, continuous operation, long-term reliability ⁽³⁾ , T_J | +125 | °C |
| Storage temperature range, T_{stg} | +300 | °C |
| ESD ratings: all pins | Human body model (HBM) | 6000 |
| | Charge device model (CDM) | 1000 |
| | Machine model (MM) | 200 |
| ESD ratings: video output pins | IEC 61000-4-2 contact discharge | 20 |
| | | kV |

- (1) Stresses these ratings may cause permanent damage. Exposure to absolute maximum conditions for extended periods may degrade device reliability. These are stress ratings only and functional operation of the device at these or any other conditions beyond those specified is not implied.
- (2) The absolute maximum junction temperature under any condition is limited by the constraints of the silicon process.
- (3) The absolute maximum junction temperature for continuous operation is limited by the package constraints. Operation above this temperature may result in reduced reliability and/or lifetime of the device.

RECOMMENDED OPERATING CONDITIONS

| | MIN | NOM | MAX | UNIT |
|----------------------------|-----|-----|-----|------|
| Supply voltage, V_{S+} | 2.6 | 3 | 5 | V |
| Ambient temperature, T_A | –40 | | +85 | °C |

ELECTRICAL CHARACTERISTICS: $V_{S+} = 3\text{ V}$, Video Section

 At $T_A = +25^\circ\text{C}$, load = $150\ \Omega \parallel 6.2\ \text{pF}$ to GND, and dc-coupled input and output, unless otherwise noted.

| PARAMETER | CONDITIONS | THS7320IYHC | | | UNIT | TEST LEVEL ⁽¹⁾ |
|-------------------------------|---|-------------|-------------------|------|-------------------------|---------------------------|
| | | MIN | TYP | MAX | | |
| AC PERFORMANCE | | | | | | |
| Passband bandwidth | –0.1 dB, relative to 1 MHz | | 11 | | MHz | C |
| | ± 1 dB, relative to 1 MHz | 14 | 17 | | MHz | A |
| –3-dB bandwidth | Relative to 1 MHz | 17 | 20 | | MHz | B |
| Normalized stop band gain | $f = 43\ \text{MHz}$, relative to 1 MHz | | –21 | –12 | dB | A |
| | $f = 54\ \text{MHz}$, relative to 1 MHz | | –27 | | dB | C |
| Group delay | $f = 100\ \text{kHz}$ | | 19 | | ns | C |
| Group delay variation | $f = 11\ \text{MHz}$ with respect to 1 MHz | | 4 | | ns | C |
| Channel-to-channel delay | | | 0.3 | | ns | C |
| Differential gain | NTSC and PAL | | 0.1 | | % | C |
| Differential phase | NTSC and PAL | | 0.1 | | ° | C |
| Total harmonic distortion | $f = 1\ \text{MHz}$, $V_O = 1.4\ V_{PP}$ | | –80 | | dB | C |
| Signal-to-noise ratio | 100 kHz to 13.5 MHz, non-weighted | | 65 | | dB | C |
| | 100 kHz to 13.5 MHz, unified weighting | | 75 | | dB | C |
| | 100 kHz to 6 MHz, non-weighted | | 69 | | dB | C |
| | 100 kHz to 6 MHz, unified weighting | | 78 | | dB | C |
| Rise/fall time | $V_{OUT} = 2\text{-V}$ step | | 20 | | ns | C |
| Slew rate | $V_{OUT} = 2\text{-V}$ step | | 80 | | V/ μs | C |
| Output impedance | $f = 12\ \text{MHz}$ | | 1.4 | | Ω | C |
| | $f = 12\ \text{MHz}$, return loss | | 41 | | dB | C |
| | Disabled | | 20 \parallel 11 | | k $\Omega \parallel$ pF | C |
| Crosstalk | Output referred at connectors, $f = 10\ \text{MHz}$ | | –51 | | dB | C |
| DC PERFORMANCE | | | | | | |
| Biased output voltage | $V_{IN} = 0\ \text{V}$ | 75 | 150 | 320 | mV | A |
| Input voltage range | At dc input, limited by output | –0.03 | 0.65 | | V | C |
| Input bias current | | –1000 | –130 | –40 | nA | A |
| Input resistance | | | 2.4 \parallel 2 | | M $\Omega \parallel$ pF | C |
| Voltage gain | | 3.92 | 4 | 4.08 | V/V | A |
| Gain matching | Channel-to-channel | –1 | ± 0.2 | +1 | % | A |
| OUTPUT CHARACTERISTICS | | | | | | |
| High output voltage swing | $R_L = 150\ \Omega$ to GND | 2.62 | 2.8 | | V | A |
| Low output voltage swing | $R_L = 150\ \Omega$ to GND | | 0.01 | | V | C |
| Output current | Short-circuit | | 65 | | mA | C |

(1) Test levels: (A) 100% tested at $+25^\circ\text{C}$. Over temperature limits set by characterization and simulation. (B) Limits set by characterization and simulation only. (C) Typical value only for information.

ELECTRICAL CHARACTERISTICS: $V_{S+} = 3\text{ V}$, Video Section (continued)

 At $T_A = +25^\circ\text{C}$, load = $150\ \Omega \parallel 6.2\ \text{pF}$ to GND, and dc-coupled input and output, unless otherwise noted.

| PARAMETER | CONDITIONS | THS7320IYHC | | | UNIT | TEST LEVEL ⁽¹⁾ |
|--|--|-------------|-------|------|---------------|---------------------------|
| | | MIN | TYP | MAX | | |
| POWER SUPPLY (V_{S+}) | | | | | | |
| Operating Voltage | V_{S+} | 2.5 | 3 | 5.5 | V | B |
| V_{S+} total quiescent current | Video enable pin = 1.8 V, no load, $V_{IN} = 0\text{ V}$ | 2.7 | 3.5 | 4.7 | mA | A |
| | Video enable pin = 0 V, no load, $V_{IN} = 0\text{ V}$ | | 0.15 | 1 | μA | A |
| V_{S+} power-supply rejection ratio (PSRR) | At dc | 44 | 50 | | dB | A |
| VIDEO ENABLE LOGIC CHARACTERISTICS | | | | | | |
| V_{IH} | Enabled | 1.17 | | | V | A |
| V_{IL} | Disabled | | | 0.4 | V | A |
| I_{IH} | Enable pin = 1.8 V, current flows into the pin | | 1.8 | 3 | μA | A |
| I_{IH} | Enable pin = 3 V, current flows into the pin | | 3 | 5 | μA | A |
| I_{IL} | Enable pin = 0 V, current flows into the pin | | -0.01 | -0.5 | μA | A |
| Input resistance | | | 1 | | M Ω | C |
| Disable time | | | 130 | | ns | C |
| Enable time | | | 120 | | ns | C |

THERMAL INFORMATION

| THERMAL METRIC ⁽¹⁾ | | THS7320IYHC | UNITS |
|-------------------------------|--|-------------|-------|
| | | YHC | |
| | | 9 PINS | |
| θ_{JA} | Junction-to-ambient thermal resistance | 159.3 | °C/W |
| $\theta_{J\text{Ctop}}$ | Junction-to-case (top) thermal resistance | 2.2 | |
| θ_{JB} | Junction-to-board thermal resistance | 2.4 | |
| Ψ_{JT} | Junction-to-top characterization parameter | 8.9 | |
| Ψ_{JB} | Junction-to-board characterization parameter | 88.4 | |
| $\theta_{J\text{Cbot}}$ | Junction-to-case (bottom) thermal resistance | n/a | |

 (1) For more information about traditional and new thermal metrics, see the *IC Package Thermal Metrics* application report, [SPRA953](#).

VIDEO PARAMETER MEASUREMENT INFORMATION

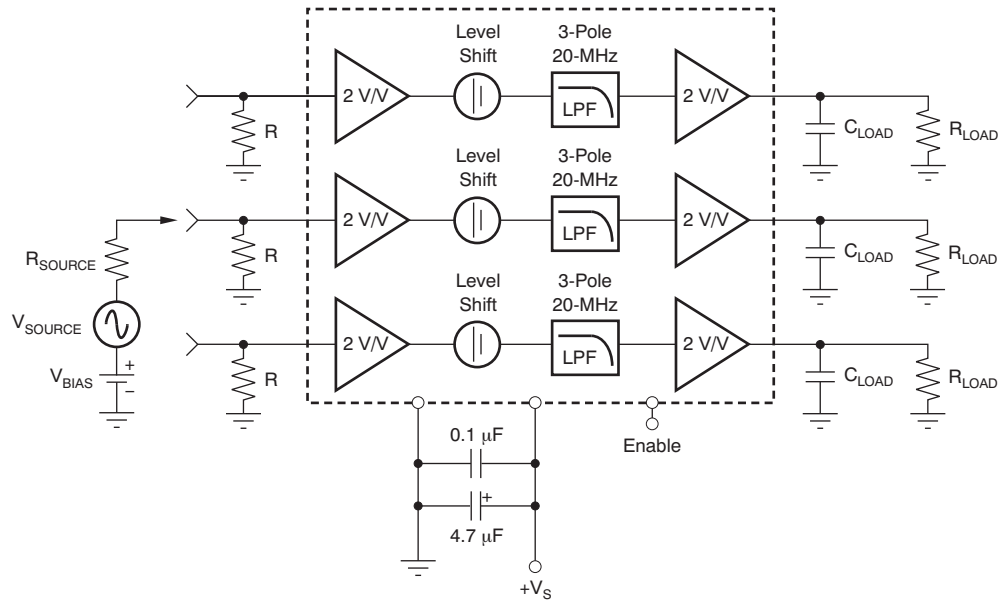
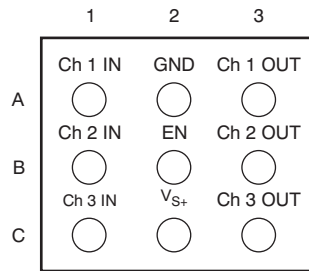

Figure 1. Test Circuit

PIN CONFIGURATION

**YHC PACKAGE
WCSP 9-BALL
(TOP VIEW)**



PIN ASSIGNMENTS

| NAME | NO. | I/O | DESCRIPTION |
|------------------|-----|-----|---|
| Channel 1 input | A1 | I | Video input, channel 1 |
| GND | A2 | I | Ground for all circuitry |
| Channel 1 output | A3 | O | Video output, channel 1 |
| Channel 2 input | B1 | I | Video input, channel 2 |
| EN | B2 | I | Video enable pin. Logic high enables the video channels; logic low disables the video channels. |
| Channel 2 output | B3 | O | Video output, channel 2 |
| Channel 3 input | C1 | I | Video input, channel 3 |
| V _{S+} | C2 | I | Power-supply pin; connect to +2.6 V up to +5 V. |
| Channel 3 output | C3 | O | Video output, channel 3 |

FUNCTIONAL BLOCK DIAGRAM

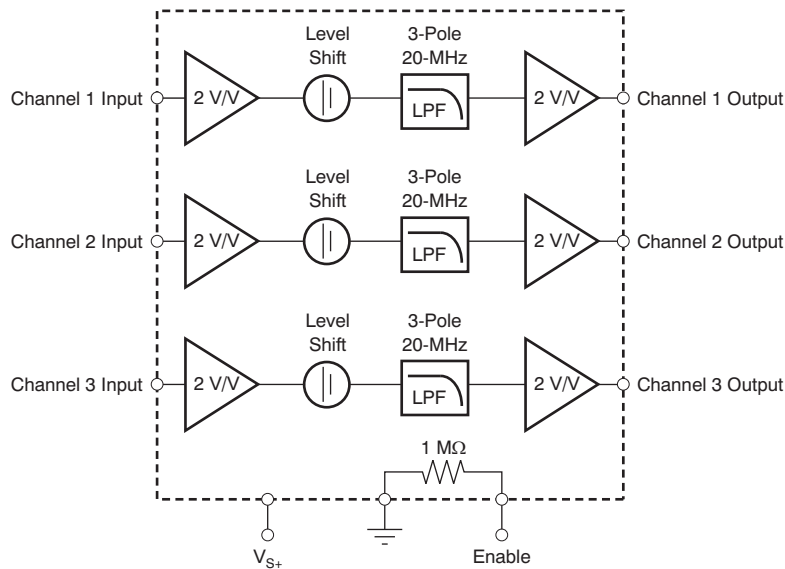

TYPICAL CHARACTERISTICS

Table 1. Table of Graphs: $V_{S+} = 2.6\text{ V}$

| TITLE | FIGURE |
|--|---|
| Signal Gain vs Frequency | Figure 2 , Figure 3 |
| Phase vs Frequency | Figure 4 |
| Group Delay vs Frequency | Figure 5 |
| Differential Gain | Figure 6 |
| Differential Phase | Figure 7 |
| Small-Signal Frequency Response vs Capacitive Load | Figure 8 |
| Small-Signal Frequency Response vs Resistive Load | Figure 9 |
| Crosstalk vs Frequency | Figure 10 |
| Second-Order Harmonic Distortion vs Frequency | Figure 11 |
| Third-Order Harmonic Distortion vs Frequency | Figure 12 |
| Large-Signal Pulse Response vs Time | Figure 13 |
| Small-Signal Pulse Response vs Time | Figure 14 |
| Slew Rate vs Output Voltage | Figure 15 |
| Enable/Disable Response vs Time | Figure 16 |

Table 2. Table of Graphs: $V_{S+} = 3\text{ V}$

| TITLE | FIGURE |
|--|---|
| Signal Gain vs Frequency | Figure 17 , Figure 18 |
| Small-Signal Frequency vs Temperature | Figure 19 , Figure 21 |
| Small-Signal Frequency vs Temperature (Enlarged) | Figure 20 , Figure 22 |
| Phase vs Frequency | Figure 23 |
| Group Delay vs Frequency | Figure 24 |
| Differential Gain | Figure 25 |
| Differential Phase | Figure 26 |
| Small-Signal Frequency Response vs Capacitive Load | Figure 27 |
| Small-Signal Frequency Response vs Resistive Load | Figure 28 |
| Crosstalk vs Frequency | Figure 29 |
| Second-Order Harmonic Distortion vs Frequency | Figure 30 |
| Third-Order Harmonic Distortion vs Frequency | Figure 31 |
| Large-Signal Pulse Response vs Time | Figure 32 |
| Small-Signal Pulse Response vs Time | Figure 33 |
| Slew Rate vs Output Voltage | Figure 34 |
| Enable/Disable Response vs Time | Figure 35 |

Table 3. Table of Graphs: $V_{S+} = 5\text{ V}$

| TITLE | FIGURE |
|--|--------------------------------------|
| Signal Gain vs Frequency | Figure 36, Figure 37 |
| Phase vs Frequency | Figure 38 |
| Group Delay vs Frequency | Figure 39 |
| Differential Gain | Figure 40 |
| Differential Phase | Figure 41 |
| Small-Signal Frequency Response vs Capacitive Load | Figure 42 |
| Small-Signal Frequency Response vs Resistive Load | Figure 43 |
| Crosstalk vs Frequency | Figure 44 |
| Second-Order Harmonic Distortion vs Frequency | Figure 45 |
| Third-Order Harmonic Distortion vs Frequency | Figure 46 |
| Large-Signal Pulse Response vs Time | Figure 47 |
| Small-Signal Pulse Response vs Time | Figure 48 |
| Slew Rate vs Output Voltage | Figure 49 |
| Enable/Disable Response vs Time | Figure 50 |

Table 4. Table of Graphs: General

| TITLE | FIGURE |
|---|---------------------------|
| Output Impedance vs Frequency | Figure 51 |
| S22 Output Return Loss vs Frequency | Figure 52 |
| Disabled Output Impedance vs Frequency | Figure 53 |
| Power-Supply Rejection Ratio vs Frequency | Figure 54 |

TYPICAL CHARACTERISTICS: $V_{S+} = 2.6\text{ V}$

At $T_A = +25^\circ\text{C}$, load = $150\ \Omega \parallel 6.2\ \text{pF}$ to GND, and dc-coupled input/output, unless otherwise noted.

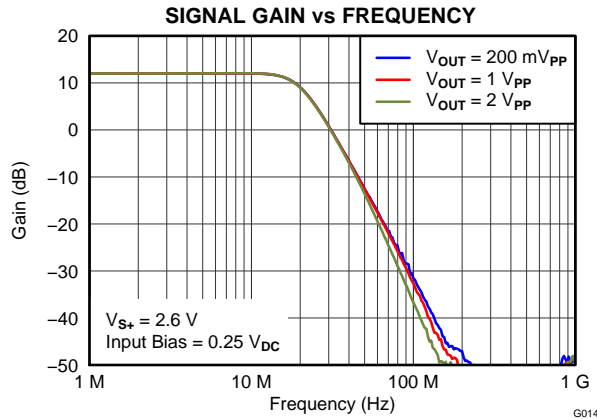

Figure 2.

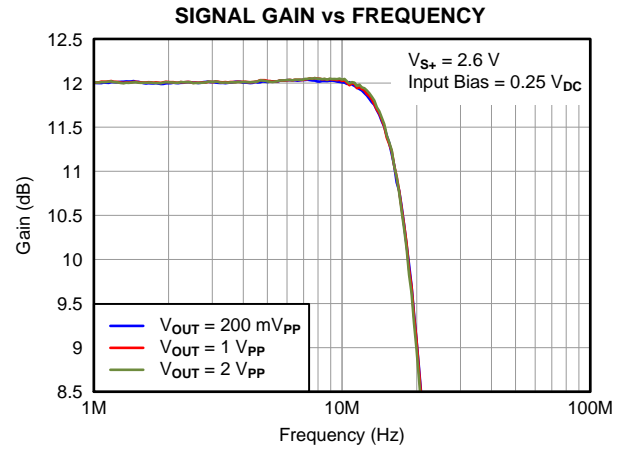

Figure 3.

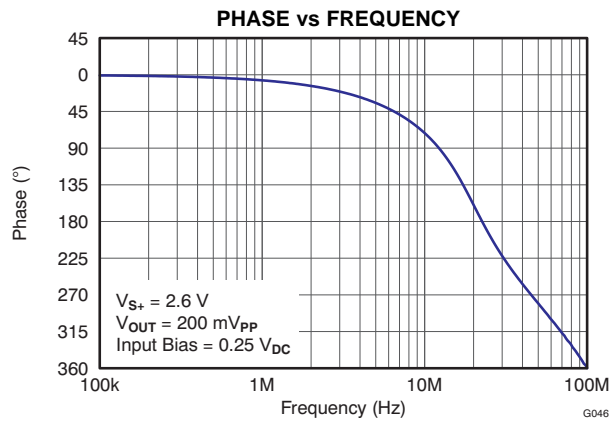

Figure 4.

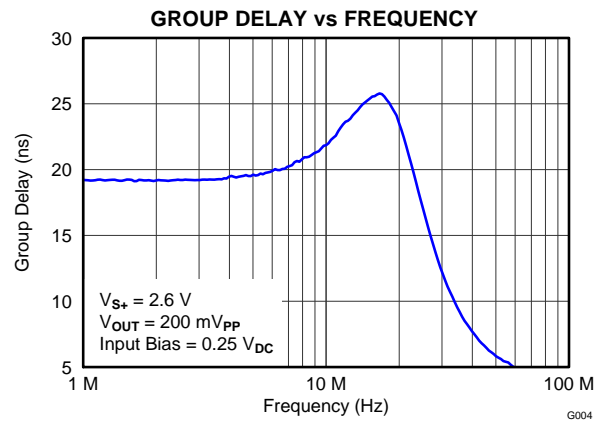

Figure 5.

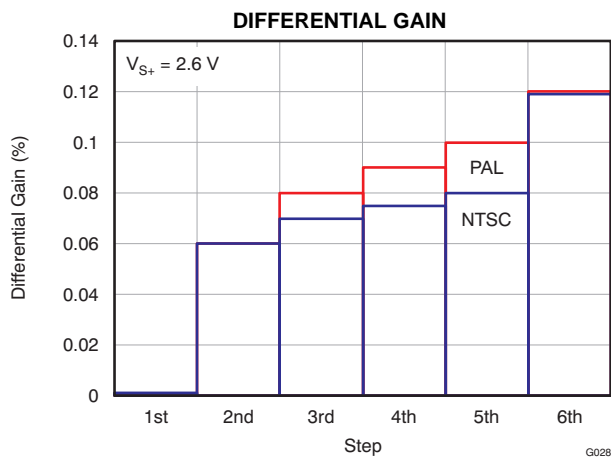

Figure 6.

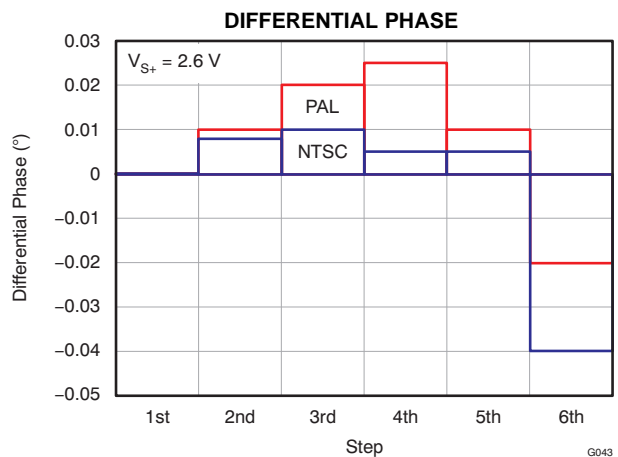

Figure 7.

TYPICAL CHARACTERISTICS: $V_{S+} = 2.6\text{ V}$ (continued)

At $T_A = +25^\circ\text{C}$, load = $150\ \Omega \parallel 6.2\text{ pF}$ to GND, and dc-coupled input/output, unless otherwise noted.

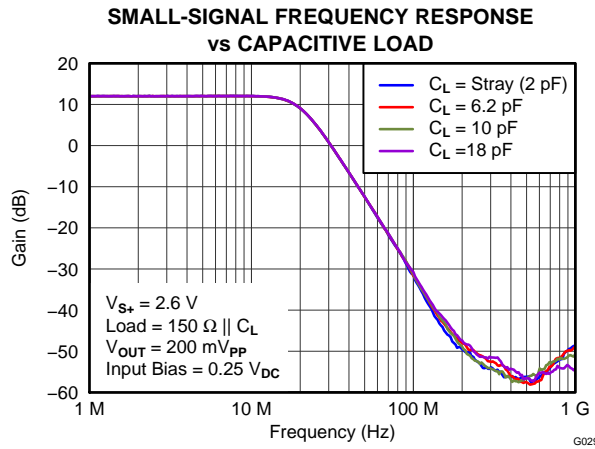

Figure 8.

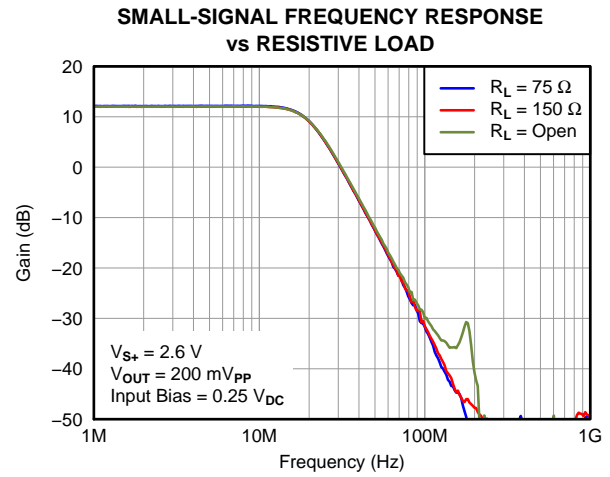

Figure 9.

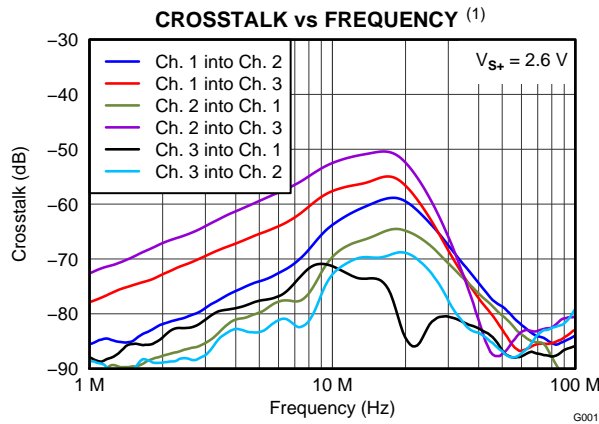

Figure 10.

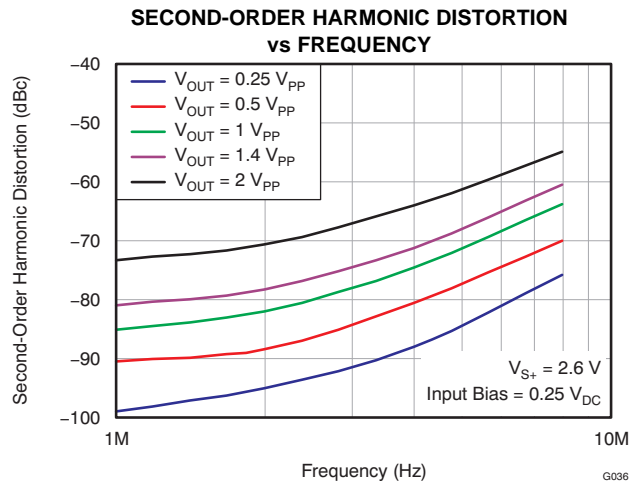

Figure 11.

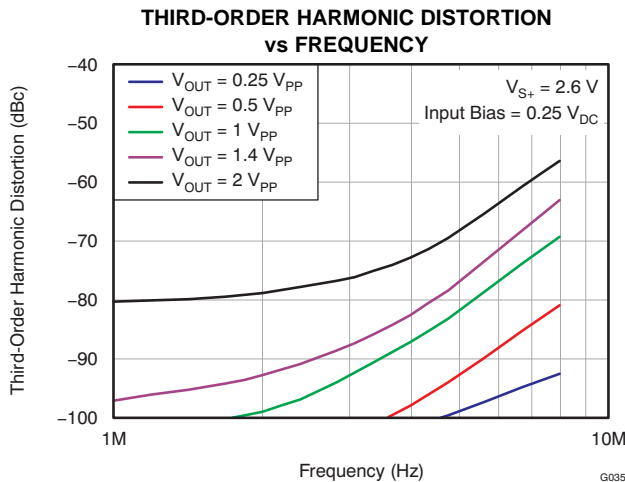

Figure 12.

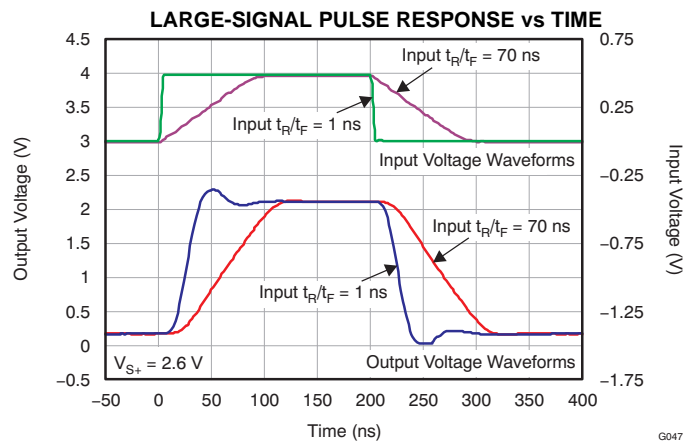

Figure 13.

(1) Measured at output connector relative to source output connector.

TYPICAL CHARACTERISTICS: $V_{S+} = 2.6\text{ V}$ (continued)

At $T_A = +25^\circ\text{C}$, load = $150\ \Omega \parallel 6.2\text{ pF}$ to GND, and dc-coupled input/output, unless otherwise noted.

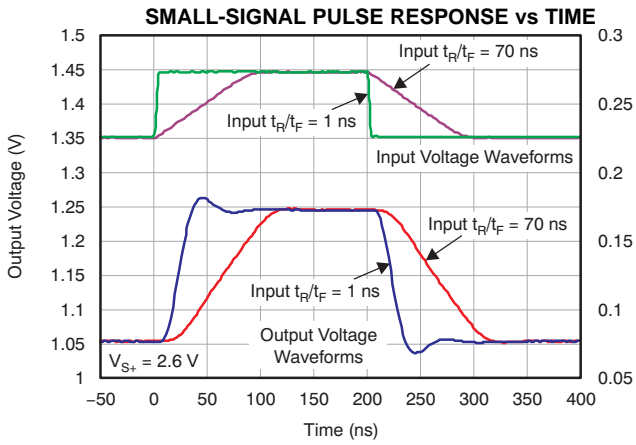

Figure 14.

G044

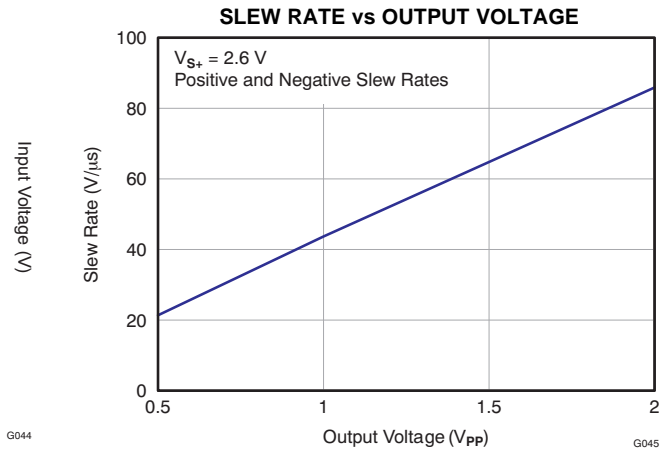

Figure 15.

G045

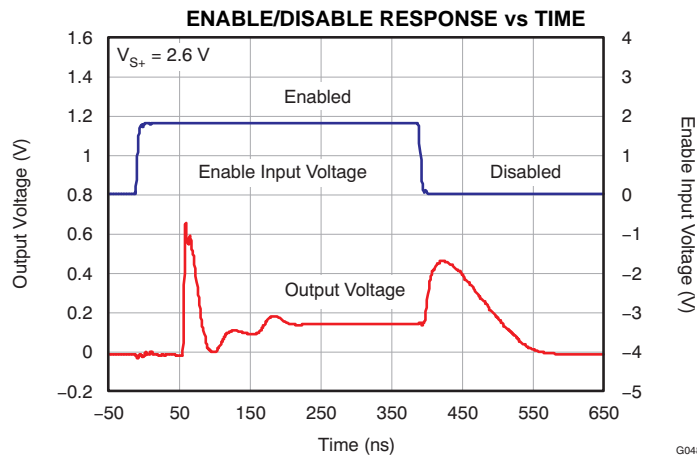

Figure 16.

G048

TYPICAL CHARACTERISTICS: $V_{S+} = 3\text{ V}$

At $T_A = +25^\circ\text{C}$, load = $150\ \Omega \parallel 6.2\ \text{pF}$ to GND, and dc-coupled input/output, unless otherwise noted.

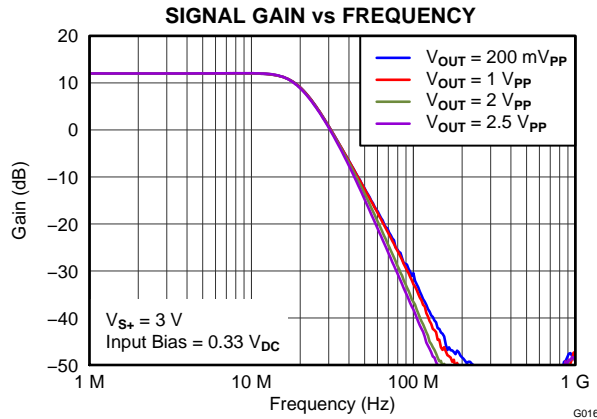

Figure 17.

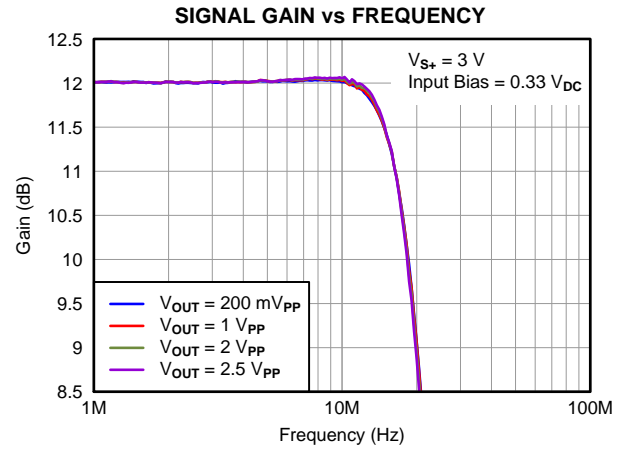

Figure 18.

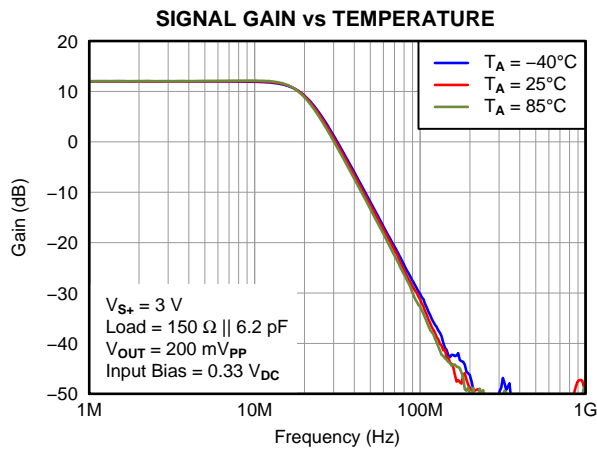

Figure 19.

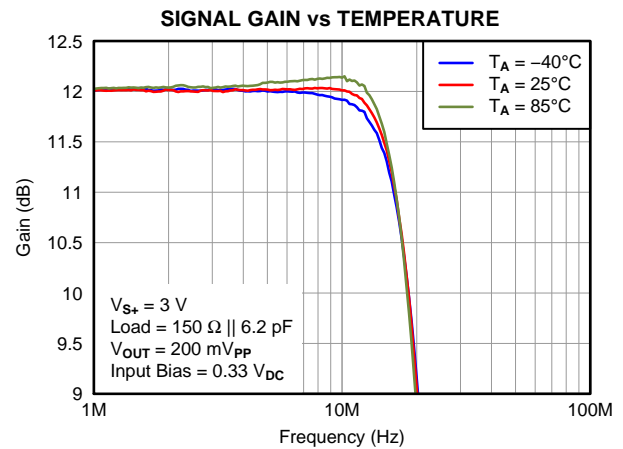

Figure 20.

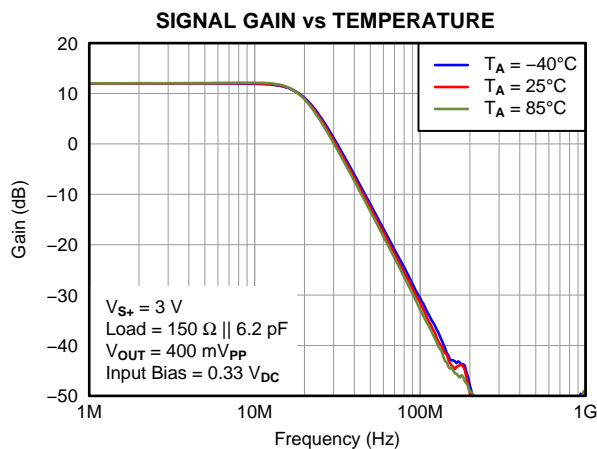

Figure 21.

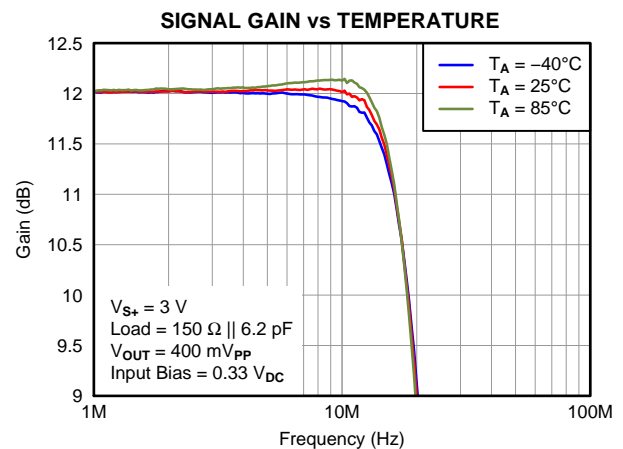

Figure 22.

TYPICAL CHARACTERISTICS: $V_{S+} = 3\text{ V}$ (continued)

At $T_A = +25^\circ\text{C}$, load = $150\ \Omega \parallel 6.2\ \text{pF}$ to GND, and dc-coupled input/output, unless otherwise noted.

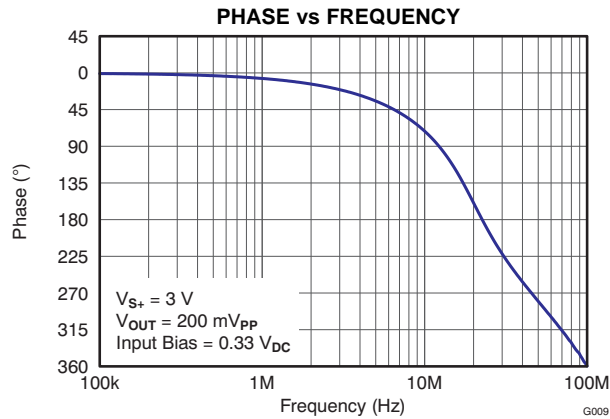

Figure 23.

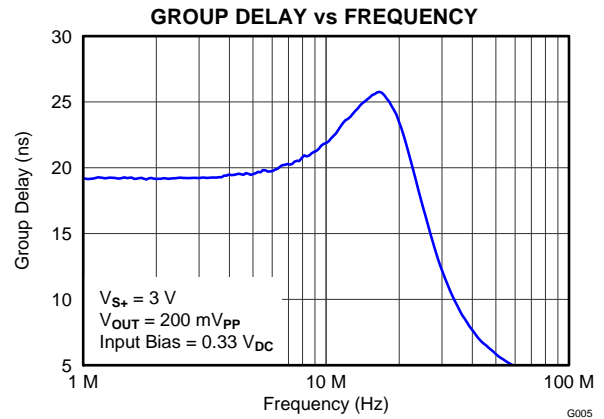

Figure 24.

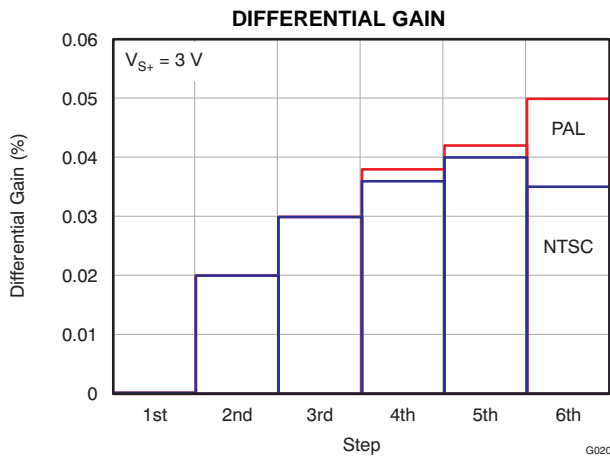

Figure 25.

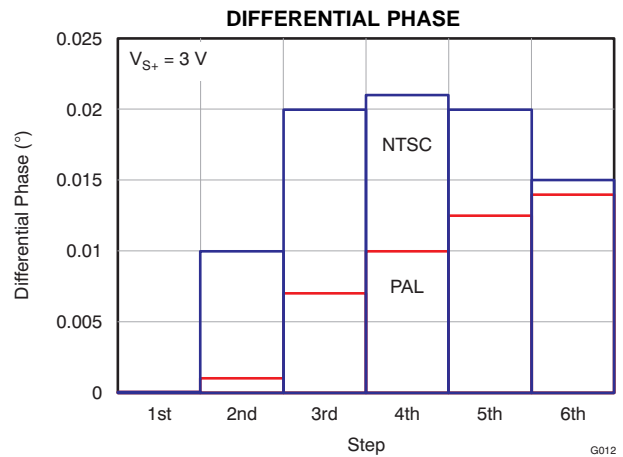

Figure 26.

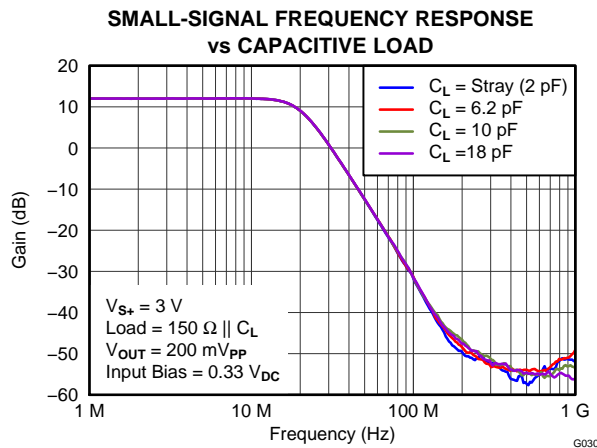

Figure 27.

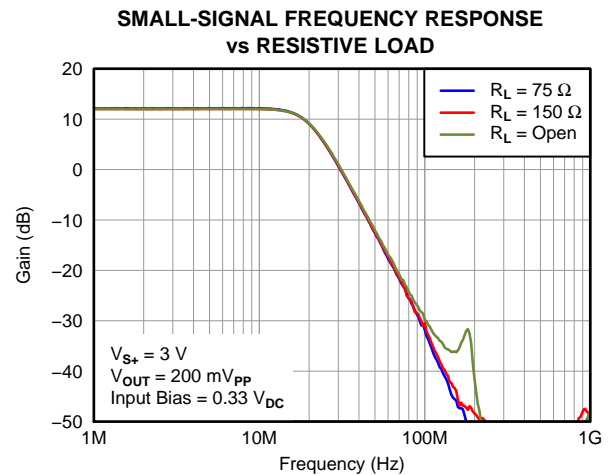

Figure 28.

TYPICAL CHARACTERISTICS: $V_{S+} = 3\text{ V}$ (continued)

At $T_A = +25^\circ\text{C}$, load = $150\ \Omega \parallel 6.2\ \text{pF}$ to GND, and dc-coupled input/output, unless otherwise noted.

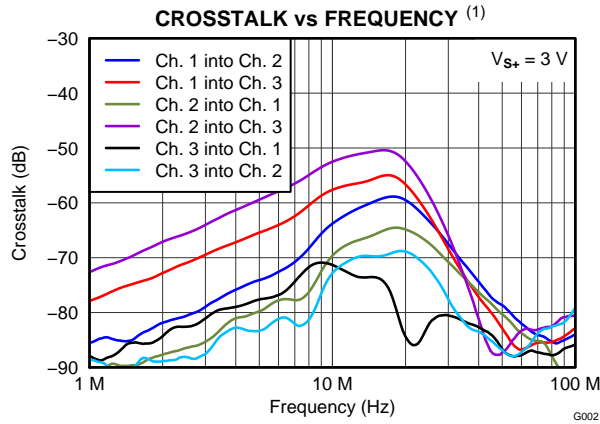

Figure 29.

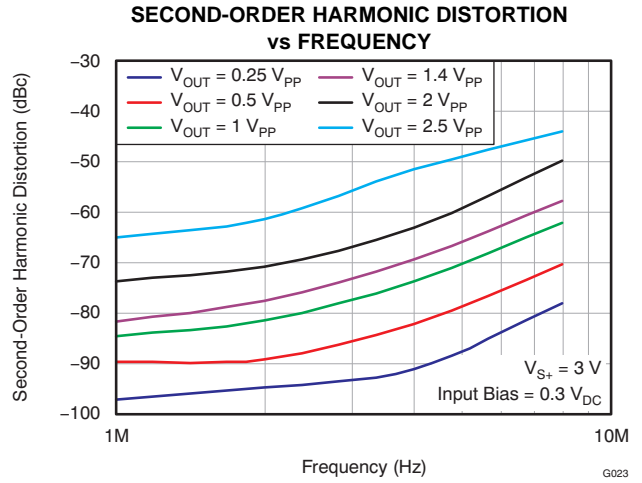

Figure 30.

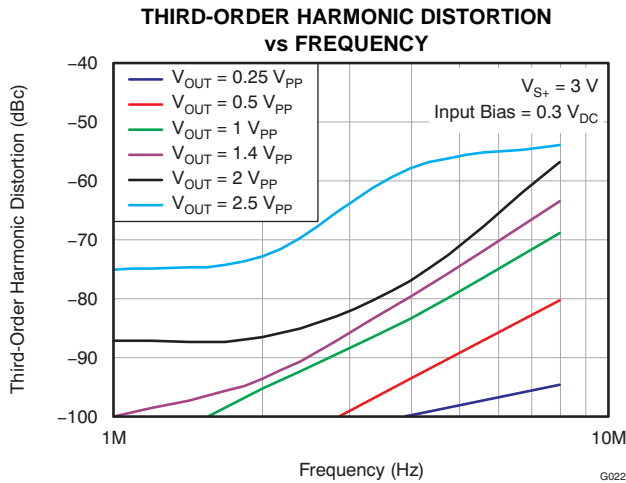

Figure 31.

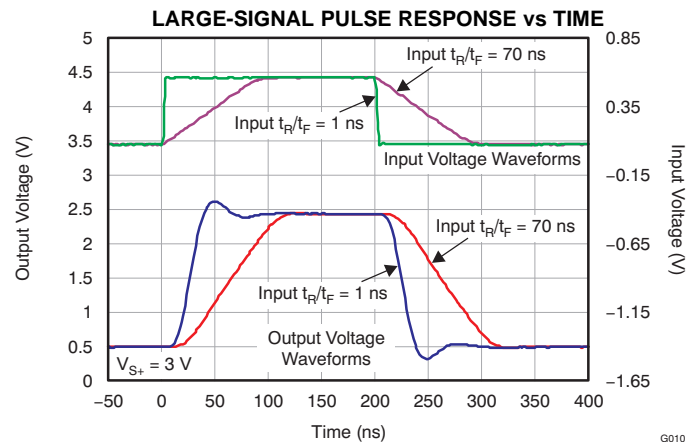

Figure 32.

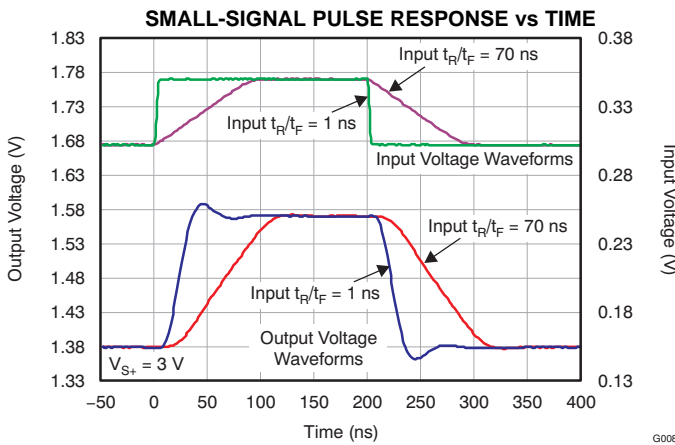

Figure 33.

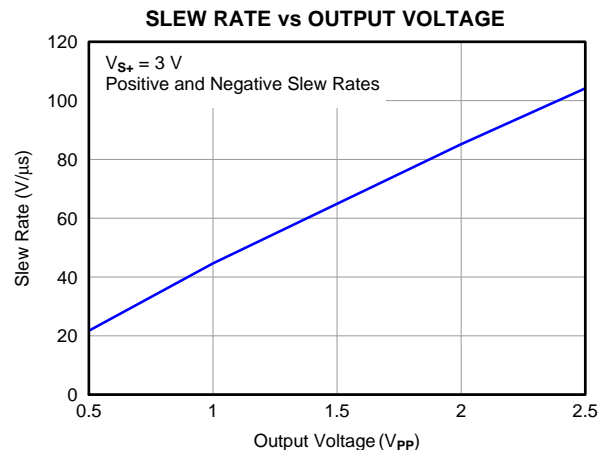

Figure 34.

(1) Measured at output connector relative to source output connector.

TYPICAL CHARACTERISTICS: $V_{S+} = 3\text{ V}$ (continued)

At $T_A = +25^\circ\text{C}$, load = $150\ \Omega \parallel 6.2\ \text{pF}$ to GND, and dc-coupled input/output, unless otherwise noted.

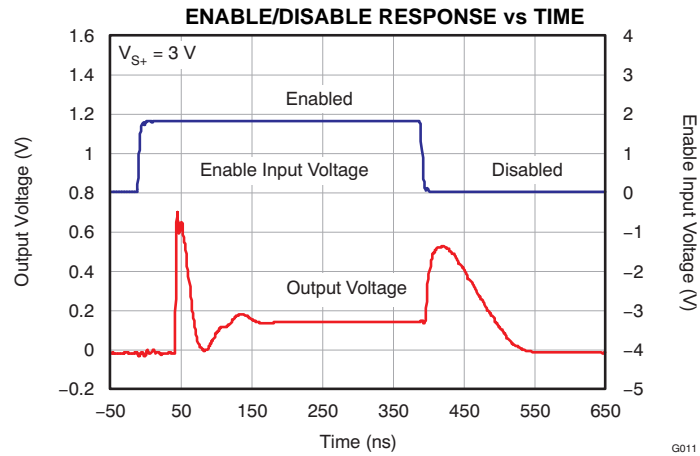

Figure 35.

TYPICAL CHARACTERISTICS: $V_{S+} = 5\text{ V}$

At $T_A = +25^\circ\text{C}$, load = $150\ \Omega \parallel 6.2\ \text{pF}$ to GND, and dc-coupled input/output, unless otherwise noted.

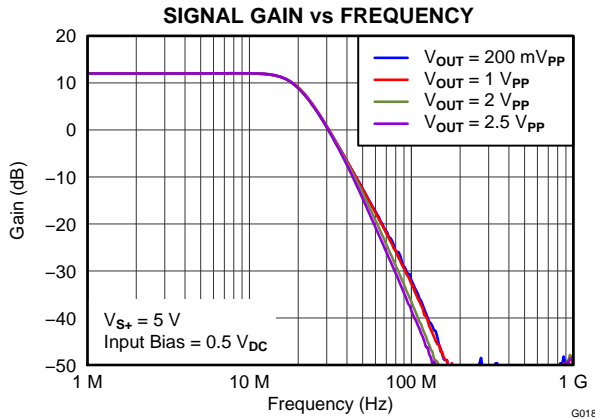

Figure 36.

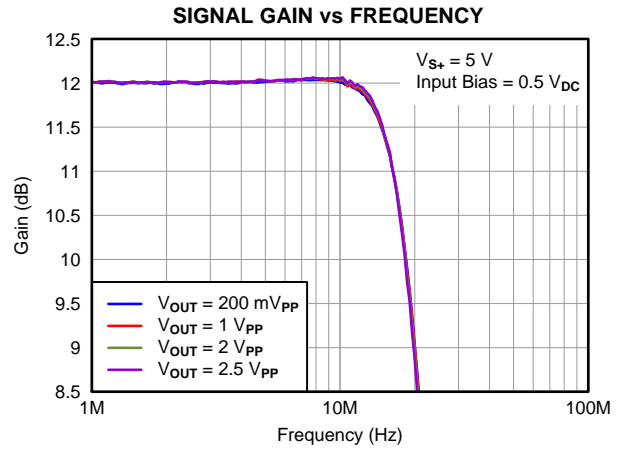

Figure 37.

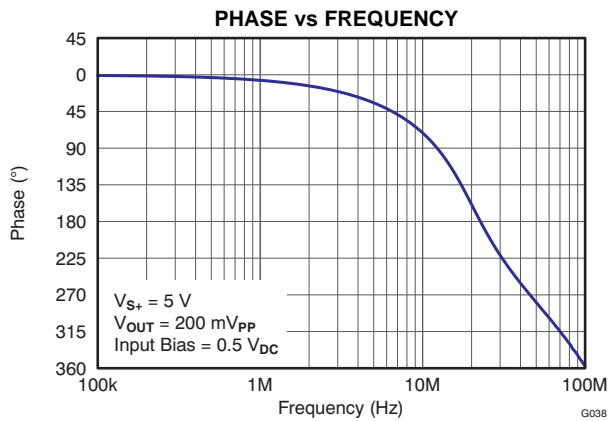

Figure 38.

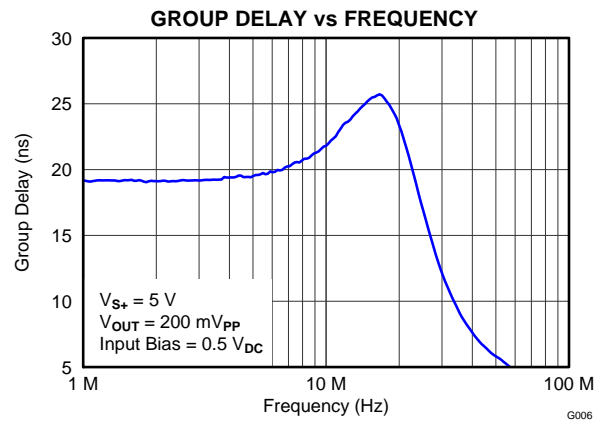

Figure 39.

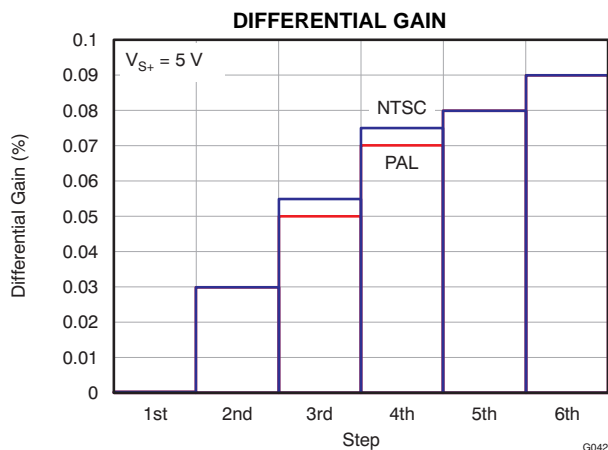

Figure 40.

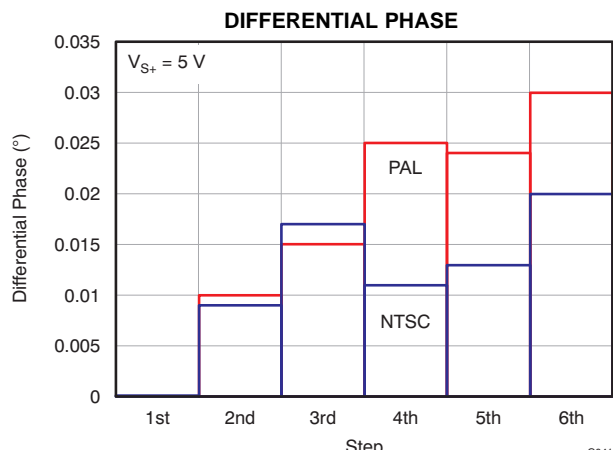

Figure 41.

TYPICAL CHARACTERISTICS: $V_{S+} = 5\text{ V}$ (continued)

At $T_A = +25^\circ\text{C}$, load = $150\ \Omega \parallel 6.2\ \text{pF}$ to GND, and dc-coupled input/output, unless otherwise noted.

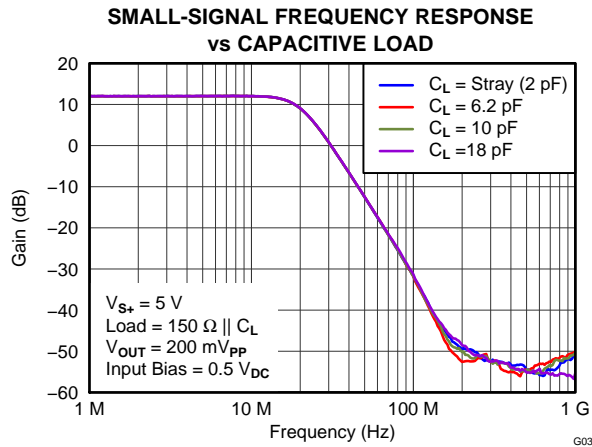

Figure 42.

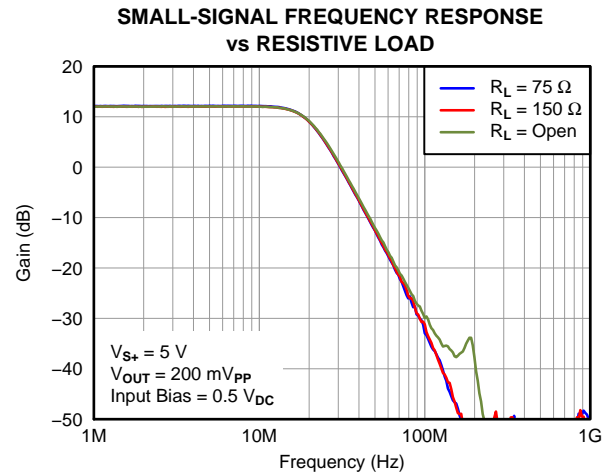

Figure 43.

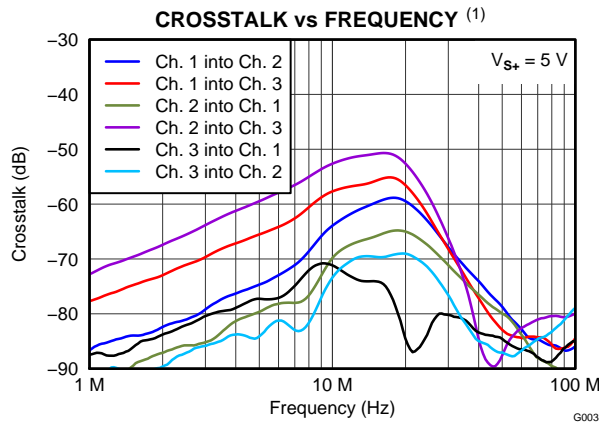

Figure 44.

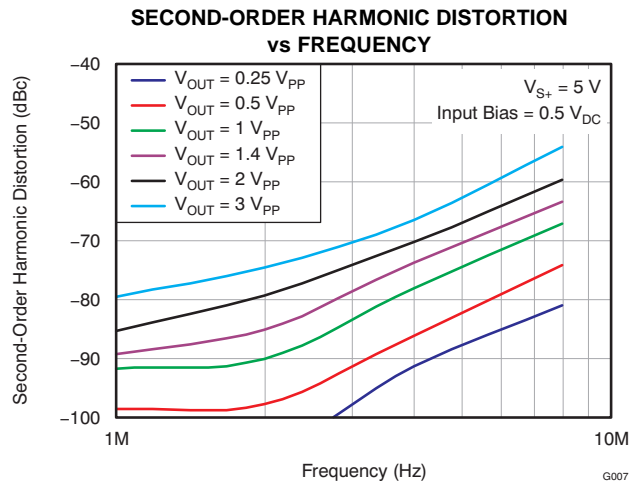

Figure 45.

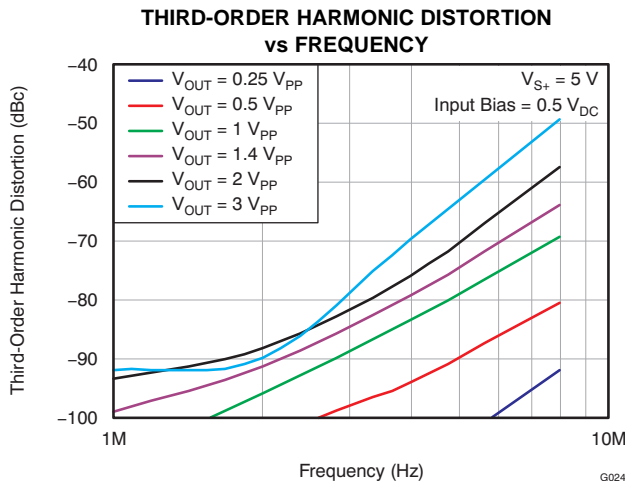

Figure 46.

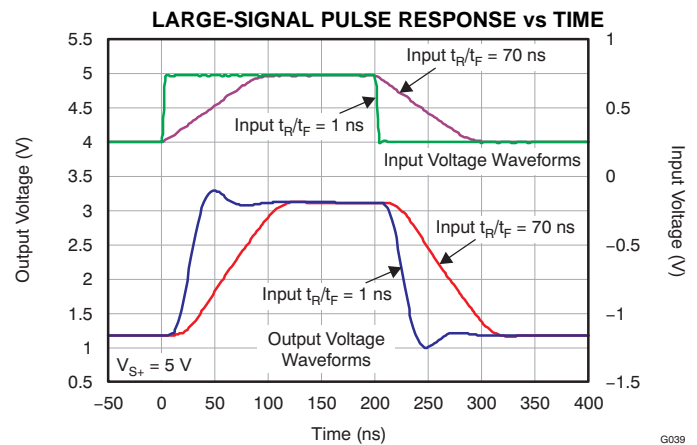

Figure 47.

(1) Measured at output connector relative to source output connector.

TYPICAL CHARACTERISTICS: $V_{S+} = 5\text{ V}$ (continued)

At $T_A = +25^\circ\text{C}$, load = $150\ \Omega \parallel 6.2\ \text{pF}$ to GND, and dc-coupled input/output, unless otherwise noted.

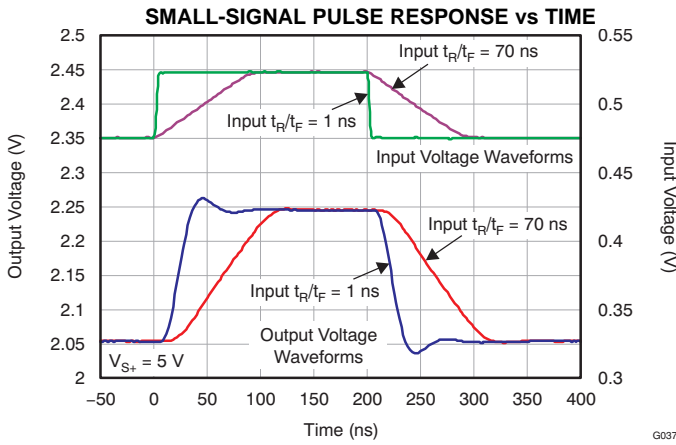

Figure 48.

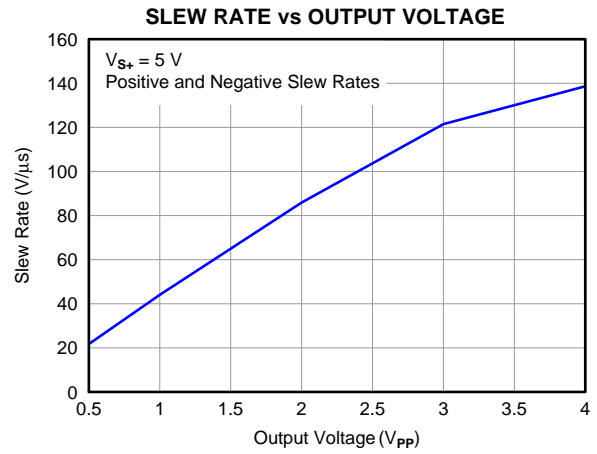

Figure 49.

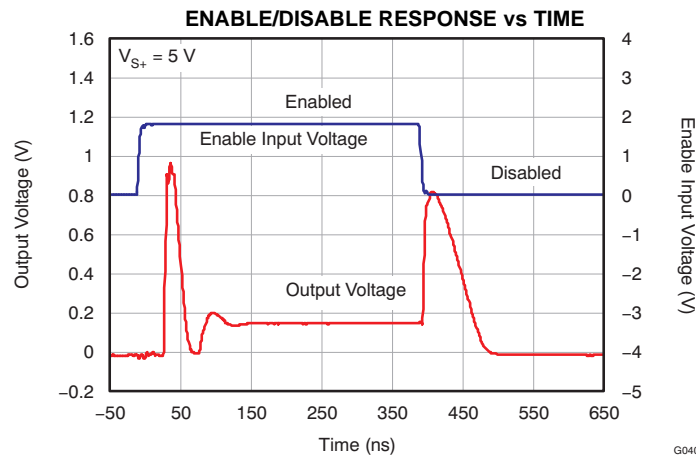

Figure 50.

TYPICAL CHARACTERISTICS: General

At TA = +25°C, load = 150 Ω || 6.2 pF to GND, and dc-coupled input/output, unless otherwise noted.

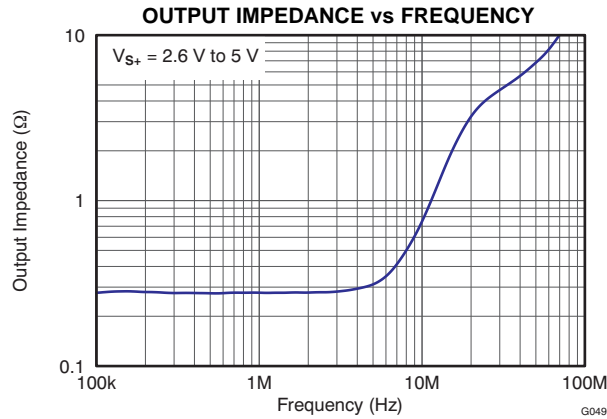

Figure 51.

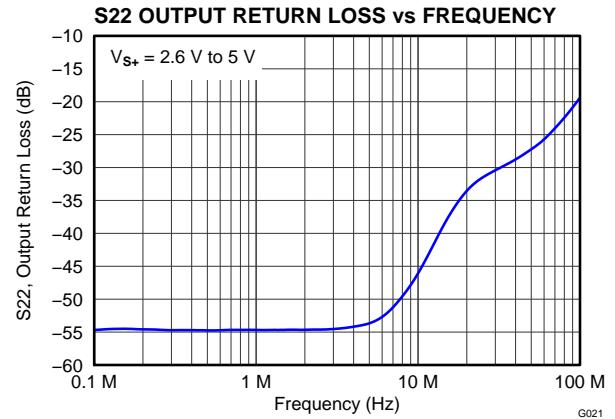

Figure 52.

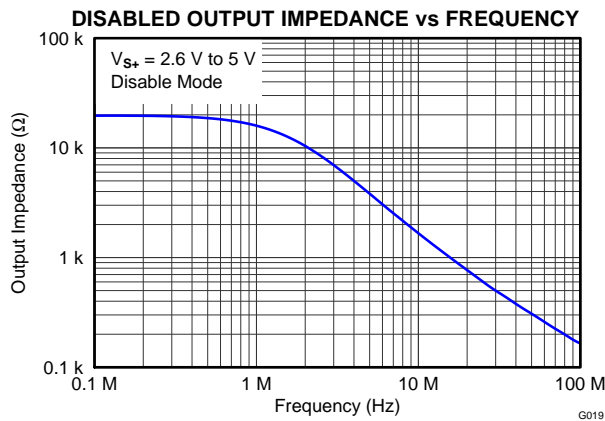

Figure 53.

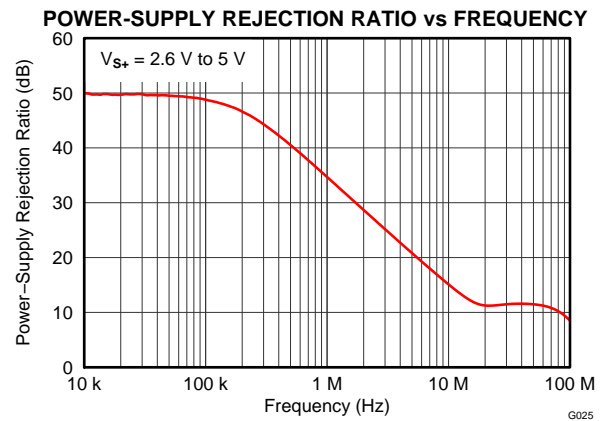

Figure 54.

APPLICATION INFORMATION

The THS7320 includes a triple-channel video output amplifier and filter that supports three enhanced-definition (ED) video and/or RGB video output buffers. The THS7320 also supports standard definition (SD) video for oversampled systems with a DAC sampling frequency of 54 MHz or greater. Although the THS7320 can be used for numerous other applications, the needs and requirements of the video signal are the most important design parameters. Built on the revolutionary, complementary silicon germanium (SiGe) BiCom3X process, the THS7320 incorporates many attributes not typically found in integrated video parts while consuming very low power. The THS7320 video portion includes these features:

- Single-supply 2.6-V to 5-V operation with low total quiescent current of 3.4 mA at 3.3 V
- Enable mode for shutting down the THS7320 video amplifiers to save system power in power-sensitive applications
- DC input configuration with internal 150-mV dc level shifting to prevent sync crushing and saturation effects
- Third-order, 20-MHz (–3-dB) low-pass filter for DAC reconstruction or ADC image rejection; ideal for:
 - NTSC/PAL 480p/576p Y'P'B'P'R or G'B'R' (R'G'B') signals
 - NTSC/PAL/SECAM composite video (CVBS), S-Video Y'/C', 480i/576i Y'P'B'P'R, and G'B'R' (R'G'B') signals for oversampled systems
- Internally-fixed gain of 4-V/V (+12-dB) amplifiers that allow for dc-coupling or traditional ac-coupling

OPERATING VOLTAGE

The THS7320 is designed to operate from 2.6 V to 5 V over the –40°C to +85°C temperature range. The impact on performance over the entire temperature range is negligible as a result of the implementation of thin film resistors and high-quality, low-temperature coefficient capacitors. The design of the THS7320 allows operation down to 2.5 V, but it is recommended to use at least a 2.7-V supply to ensure that no issues arise with headroom or clipping with 100% color-saturated CVBS signals. If only 75% color saturated CVBS is supported, then the output voltage requirements are reduced to 2 V_{PP} on the output, allowing a 2.6-V supply to be used without issues.

A 0.1-μF capacitor should be placed as close as possible to each power-supply pin to avoid potential ringing or oscillation. Additionally, a large capacitor (such as 4.7 μF to 100 μF) should be placed on the power-supply line to minimize interference with 50-Hz/60-Hz line frequencies.

VIDEO INPUT VOLTAGE

The THS7320 input range allows for an input signal range from –0.06 V to approximately (V_{S+} – 1.5 V). However, because of the internal fixed gain of 4 V/V (+12 dB) and the internal output level shift of 150 mV (typical), the output is generally the limiting factor for the allowable linear input range. For example, with a 3-V supply, the linear input range is from 0.15 V to 0.75 V. However, because of the gain and level shift, the linear output range limits the allowable linear input range from approximately –0.03 V to 0.65 V.

VIDEO INPUT OVERVOLTAGE PROTECTION

The THS7320 is built using a very high-speed, complementary, bipolar CMOS process. The internal junction breakdown voltages are relatively low for these very small geometry devices. These breakdowns are reflected in the [Absolute Maximum Ratings](#) table. All input and output device pins are protected with internal electrostatic discharge (ESD) protection diodes to the power supplies, as shown in [Figure 55](#).

These diodes provide moderate protection to input overdrive voltages above and below the supplies as well. The protection diodes can typically support 30 mA of continuous current when overdriven.

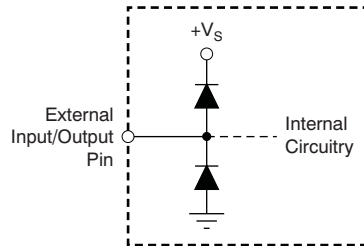

Figure 55. Internal ESD Protection For Video Section

TYPICAL VIDEO CONFIGURATION AND VIDEO TERMINOLOGY

A typical application circuit using the THS7320 as a video buffer is shown in [Figure 56](#). It shows a DAC or encoder dc-coupled to the input channels of the THS7320 and the output of the THS7320 dc-coupled to the video line. These signals can be NTSC, PAL, or SECAM signals including composite video baseband signal (CVBS), S-Video Y'C', component Y'P'B'P'R video, broadcast G'B'R' video, or computer R'G'B' video signals.

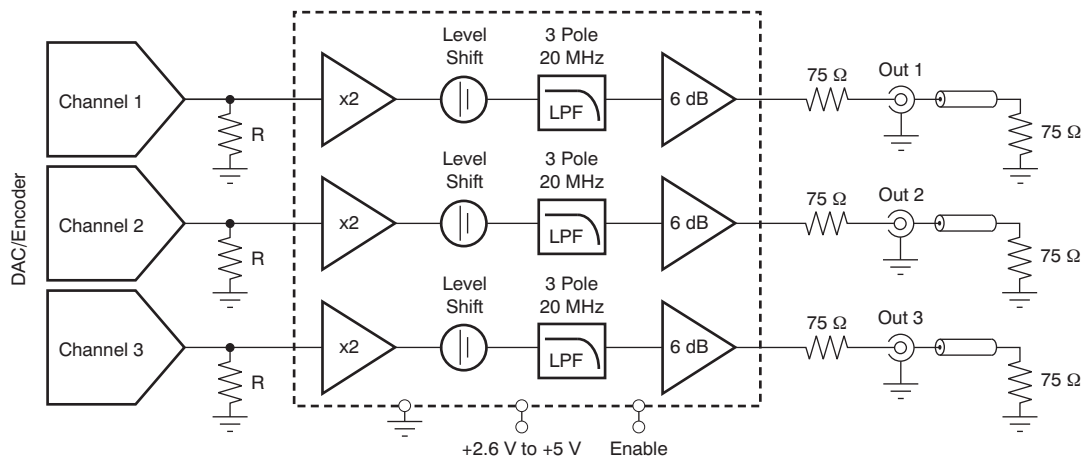

Figure 56. Typical THS7320 Video Section with DC-Coupled Encoder/DAC and DC-Coupled Line Driving

Note that the Y' term is used for the luma channels throughout this document rather than the more common luminance (Y) term. This usage accounts for the definition of luminance as stipulated by the [International Commission on Illumination \(CIE\)](#). Video departs from true luminance because a nonlinear term, *gamma*, is added to the true RGB signals to form R'G'B' signals. These R'G'B' signals are then used to mathematically create luma (Y'). Thus, luminance (Y) is not maintained, providing a difference in terminology.

This rationale is also used for the chroma (C') term. Chroma is derived from the nonlinear R'G'B' terms and, thus, it is nonlinear. Chrominance (C) is derived from linear RGB, giving the difference between chroma (C') and chrominance (C). The color difference signals ($P'_B/P'_R/U'/V'$) are also referenced in this manner to denote the nonlinear (gamma corrected) signals.

R'G'B' (commonly mislabeled *RGB*) is also called G'B'R' (again commonly mislabeled as *GBR*) in professional video systems. The Society of Motion Picture and Television Engineers (SMPTE) component standard stipulates that the luma information is placed on the first channel, the blue color difference is placed on the second channel, and the red color difference signal is placed on the third channel. This practice is consistent with the Y'P'B'P'R nomenclature. Because the luma channel (Y') carries the sync information and the green channel (G') also carries the sync information, it makes logical sense that G' be placed first in the system. Because the blue color difference channel (P'B) is next and the red color difference channel (P'R) is last, then it also makes logical sense to place the B' signal on the second channel and the R' signal on the third channel, respectfully. Thus, hardware compatibility is better achieved when using G'B'R' rather than R'G'B'. Note that for many G'B'R' systems, sync is embedded on all three channels, but this configuration may not always be the case in all systems.

INPUT OPERATION

The THS7320 allows for dc-coupled inputs. Most DACs or video encoders can be dc-connected to the THS7320 with essentially any DAC termination resistance desired for the system. One of the potential drawbacks to dc-coupling is when 0 V is applied to the input from the DAC. Although the input of the THS7320 allows for a 0-V input signal without issue, the output swing of a traditional amplifier cannot yield a 0-V signal that results in possible clipping of the signal. This limitation is true for any single-supply amplifier because of the characteristics of the output transistors. Neither CMOS nor bipolar transistors can achieve 0 V while sinking current. This transistor characteristic is also the same reason why the highest output voltage is always less than the power-supply voltage when sourcing current.

This output clipping can reduce the sync amplitudes (both horizontal and vertical sync) on the video signal. A problem occurs if the video signal receiver uses an automatic gain control (AGC) loop to account for losses in the transmission line. Some video AGC circuits derive gain from the horizontal sync amplitude. If clipping occurs on the sync amplitude, then the AGC circuit can increase the gain too much—resulting in too much luma and/or chroma amplitude gain correction. This correction may result in a picture with an overly bright display with too much color saturation.

Other AGC circuits may use the chroma burst amplitude for amplitude control. For this situation, reduction in the sync signals does not alter the proper gain setting. However, it is good engineering design practice to ensure that saturation/clipping does not take place. Transistors always take a finite amount of time to come out of saturation. This saturation could possibly result in timing delays or other aberrations on the signals that may not be desirable.

To eliminate saturation or clipping problems, the THS7320 has a 150-mV output level shift feature. This feature takes the input voltage and adds an internal +37.5-mV shift to the input signal. Because of the 12-dB (4-V/V) gain, the resulting output with a 0-V applied input signal is approximately 150 mV. The THS7320 rail-to-rail output stage can create this output level while connected to a typical video load. This configuration ensures the sync signal clipping or saturation does not occur. This shift is constant, regardless of the input signal. The equation for this level shift is $V_{OUT} = (V_{IN} \times 4 \text{ V/V}) + 0.15 \text{ V}$. For example, if a 0.5-V input is applied, the output is $(0.5 \text{ V} \times 4 \text{ V/V}) + 0.15 \text{ V} = 2.15 \text{ V}$.

Because the internal gain is fixed at +12 dB (4 V/V), it dictates the allowable linear input voltage range. For example, if the power supply is set to 3 V, the maximum output is approximately 2.9 V while driving a significant amount of current. Thus, to avoid clipping, the allowable input is $([2.8 \text{ V} - 0.15 \text{ V}]/4) = 0.66 \text{ V}$. This range is valid for up to the maximum recommended 5-V power supply that allows approximately a $([4.8 \text{ V} - 0.15 \text{ V}]/4) = 1.16\text{-V}$ input range while avoiding clipping on the output.

The input impedance of the THS7320 is dictated by the internal high-impedance gain of 2 V/V initial amplifier, as shown in Figure 57. This buffer has a very high 2.4-M Ω || 2-pF input impedance that is effectively transparent to the source with no interactions. Unlike other products where the filter elements are tied directly to the input pin without buffering, there are no filter performance changes or interaction with the DAC termination resistance. Note that the internal voltage shift does not appear at the input pin; it only shows at the output pin.

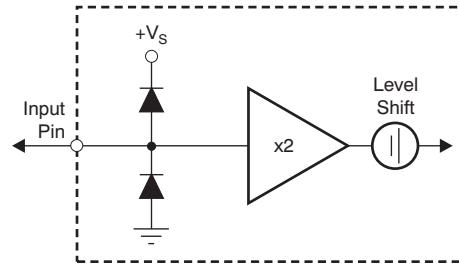

Figure 57. Equivalent Video Section DC Input Mode Circuit

While ac-coupling with dc-biasing using external resistor dividers can be done, it is generally not recommended because of the large resistor values required. These large resistor values coupled with the input bias current of the THS7320 input can cause a significant voltage shift to appear on the input. If ac-coupling is necessary for a system, several elements must be taken into account for a proper design: the high-pass corner frequency (typically desired to be approximately 2.5 Hz); the size of the input capacitor value; the parallel input resistance of the voltage divider; and the input bias current. Contact Texas Instruments for design support if ac-coupling is necessary in the design.

DC-COUPLED OUTPUT

The THS7320 video section incorporates a rail-to-rail output stage that can drive the line directly without the need for large ac-coupling capacitors. This design offers the best line tilt and field tilt (droop) performance because no ac-coupling occurs. Keep in mind that if the input is ac-coupled, then the resulting tilt as a result of the input ac-coupling continues to be seen on the output, regardless of the output coupling. The 70-mA output current drive capability of the THS7320 is designed to drive the video line while keeping the output dynamic range as wide as possible.

One concern of dc-coupling, however, arises if the line is terminated to ground. If an ac-bias input configuration is used or if a dc reference from the DAC is applied, such as S-Video C'/component P_B/or component P_R signals, the output of the THS7320 then has a dc bias on the output, such as 1 V. This configuration allows a dc current path to flow, such as $1\text{ V}/150\ \Omega = 6.67\text{ mA}$. The result of this configuration is a slightly decreased high output voltage swing and an increase in power dissipation of the THS7320. While the THS7320 was designed to operate with a junction temperature of up to +125°C, care must be taken to ensure that the junction temperature does not exceed this level or else long-term reliability could suffer. Using a 5-V supply, this configuration can result in an additional power dissipation of $(5\text{ V} - 1\text{ V}) \times 6.67\text{ mA} = 26.7\text{ mW}$ per channel. With a 3.3-V supply, this dissipation reduces to 15.3 mW per channel. The overall low quiescent current of the THS7320 design minimizes potential thermal issues even when used at high ambient temperatures, but power and thermal analysis should always be examined in any system to ensure that no issues arise. Be sure to use RMS power and not instantaneous power when evaluating the thermal performance.

Note that the THS7320 can drive the line with dc-coupling regardless of the input mode of operation. The only requirement is to make sure the video line has proper termination in series with the output (typically 75 Ω). This requirement helps isolate capacitive loading effects from the THS7320 output. Failure to properly isolate capacitive loads may result in ringing or oscillation. The stray capacitance appearing directly at the THS7320 output pins should be kept below 18 pF. One method to ensure this condition is valid is to verify that the 75- Ω source resistor is placed next to each THS7320 output pin.

There are many reasons dc-coupling is desirable, including reduced costs, PCB area reduction, and no line tilt or field tilt. A common question is whether or not there are any drawbacks to using dc-coupling. There are a few potential issues that must be examined, such as the dc current bias as discussed above. Another potential risk is whether this configuration meets industry standards. EIA-770 stipulates that the *back porch* shall be $0\text{ V} \pm 1\text{ V}$ as measured at the receiver. With a double-terminated load system, this requirement implies a $0\text{-V} \pm 2\text{-V}$ level at the video amplifier output. The THS7320 can easily meet this requirement without issue. However, in Japan, the EIAJ CP-1203 specification stipulates a $0\text{-V} \pm 0.1\text{-V}$ level with no signal. This requirement can be met with the THS7320 in disable mode, but while active it cannot meet this specification without output ac-coupling.

AC-COUPLED OUTPUT

A very common method of coupling the video signal to the line is with a large capacitor. This capacitor is typically between $220\ \mu\text{F}$ and $1000\ \mu\text{F}$, although $470\ \mu\text{F}$ is very typical. The value of this capacitor must be large enough to minimize the line tilt (droop) and/or field tilt associated with ac-coupling as described previously in this document. AC-coupling is performed for several reasons, but the most common is to ensure full interoperability with the receiving video system. This approach ensures that regardless of the reference dc voltage used on the transmitting side, the receiving side re-establishes the dc reference voltage to its own requirements.

In the same way as the dc output mode of operation discussed previously, each line should have a $75\text{-}\Omega$ source termination resistor in series with the ac-coupling capacitor. This $75\text{-}\Omega$ series resistor should be placed next to the THS7320 output to minimize capacitive loading effects.

Because of the edge rates and frequencies of operation, it is recommended (but not required) to place a $0.1\text{-}\mu\text{F}$ to $0.01\text{-}\mu\text{F}$ capacitor in parallel with the large $220\text{-}\mu\text{F}$ to $1000\text{-}\mu\text{F}$ capacitor. These large value capacitors are generally aluminum electrolytic. It is well-known that these capacitors have significantly large equivalent series resistance (ESR), and the impedance at high frequencies is rather large as a result of the associated inductances involved with the leads and construction. The small $0.1\text{-}\mu\text{F}$ to $0.01\text{-}\mu\text{F}$ capacitors help pass these high-frequency signals (greater than 1 MHz) with much lower impedance than the large capacitors.

Although it is common to use the same capacitor values for all the video lines, the frequency bandwidth of the chroma signal in an S-Video system is not required to perform at as low (or as high) a frequency as the luma channels. Thus, the capacitor values of the chroma line(s) can be smaller, such as $0.1\ \mu\text{F}$.

Figure 58 shows a typical configuration where the input is dc-coupled and the output is also ac-coupled. AC-coupled inputs are generally required when current-sink DACs are used or the input is connected to an unknown source, such as when the THS7320 is used as an input device.

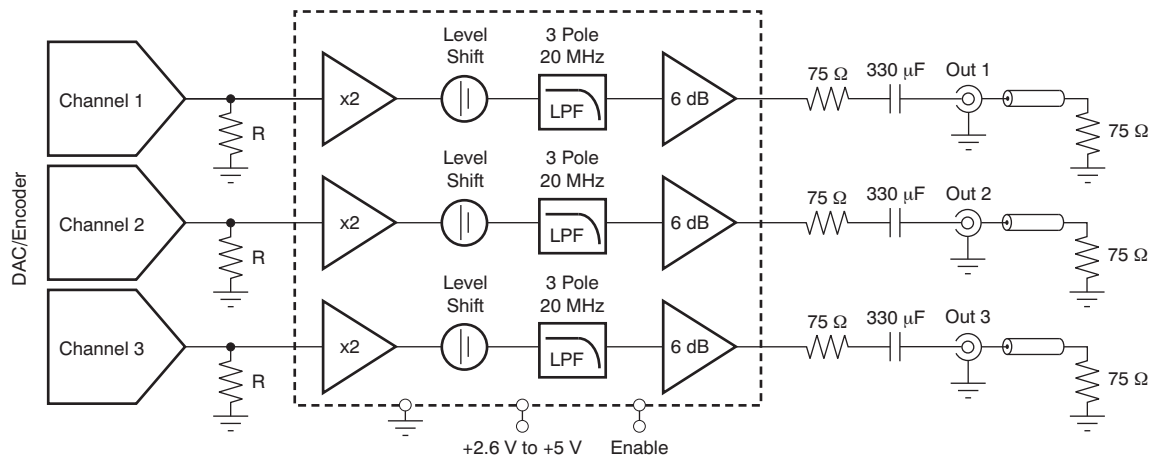

Figure 58. Typical DC Input System Driving AC-Coupled Video Lines

LOW-PASS FILTER

Each channel of the THS7320 video section incorporates a third-order, low-pass filter. These video reconstruction filters minimize DAC images from being passed on to the video receiver. Depending on the receiver design, failure to eliminate these DAC images can cause picture quality problems as a result of aliasing of the ADC in the receiver. Another benefit of the filter is to smooth out aberrations in the signal that DACs typically have associated with the digital stepping of the signal. This benefit helps with picture quality and ensures that the signal meets video bandwidth requirements.

Each filter has an associated Butterworth characteristic. The benefit of the Butterworth response is that the frequency response is flat with a relatively steep initial attenuation at the corner frequency. The concern with the Butterworth characteristic is that the group delay rises near the corner frequency. Group delay is defined as the change in phase (radians/second) divided by a change in frequency. An increase in group delay corresponds to a time domain pulse response that has overshoot and some possible ringing associated with the overshoot.

The use of other type of filters, such as elliptic or Chebyshev, is not recommended for video applications because of the very large group delay variations near the corner frequency resulting in significant overshoot and ringing. While these filters may help meet the video standard specifications with respect to amplitude attenuation, the group delay is well beyond the standard specifications. Considering this group delay with the fact that video can go from a white pixel to a black pixel over and over again, it is easy to see that ringing can occur. Ringing typically causes a display to have ghosting or fuzziness appear on the edges of a sharp transition. On the other hand, a Bessel filter has ideal group delay response, but the rate of attenuation is typically too low for acceptable image rejection. Thus, the Butterworth filter is an acceptable compromise for both attenuation and group delay.

The THS7320 filters have a nominal corner (-3 -dB) frequency at 20 MHz and a -1 -dB passband typically at 17 MHz. This 20-MHz filter is ideal for enhanced definition (ED) NTSC or PAL 480p/576p $Y'P'_BP'_R$ or $G'B'R'/R'G'B'$ signals. For oversampled systems, the THS7320 works well for passing standard definition (SD) NTSC, PAL, or SECAM composite video (CVBS), S-Video signals ($Y'C'$), 480i/576i $Y'P'_BP'_R$, $Y'U'V'$, broadcast $G'B'R'$ signals, and $R'G'B'$ video signals. The 20-MHz, -3 -dB corner frequency was designed to achieve 27-dB of attenuation at 54 MHz—a common sampling frequency between the DAC/ADC second and third Nyquist zones found in many video systems. This consideration is important because any signal that appears around this frequency can also appear in the baseband as a result of aliasing effects of an ADC found in a receiver. Another specification ensured for the THS7320 is attenuation at 43 MHz. This frequency is derived from the fact that the ED Y' signal has an 11-MHz bandwidth. Following standard sampling theory, this means that the second Nyquist zone image starts at $54 \text{ MHz} - 11 \text{ MHz} = 43 \text{ MHz}$.

Keep in mind that images do not stop at the DAC sampling frequency, f_S (for example, 54 MHz for traditional ED DACs); they continue around the sampling frequency harmonics of $2 \times f_S$, $3 \times f_S$, $4 \times f_S$, and so on (that is, 108 MHz, 162 MHz, 216 MHz, etc.). Because of these multiple images, an ADC can fold down into the baseband signal, meaning that the low-pass filter must also eliminate these higher-order images. The THS7320 filters are designed to attenuate all of these higher frequencies without *bounce* effect that some filters can allow.

The filter frequencies were chosen to account for process variations in the THS7320. To ensure the required video frequencies are effectively passed, the filter corner frequency must be high enough to allow component variations. The other consideration is that the attenuation must be large enough to ensure the anti-aliasing/reconstruction filtering is sufficient to meet the system demands. Thus, the recommendations for the filter frequencies was not arbitrarily selected and is a good compromise that should meet the demands of most systems.

BENEFITS OVER PASSIVE FILTERING

Two key benefits of using an integrated filter system (such as the THS7320) over a passive system are PCB area and filter variations. The ultra-small MicrostarCSP 9-ball package is much smaller over a passive RLC network, especially a three-pole passive network for three channels. Additionally, consider that inductors have at best $\pm 10\%$ tolerances (normally, $\pm 15\%$ to $\pm 20\%$ is common) and capacitors typically have $\pm 10\%$ tolerances. A Monte Carlo analysis shows that the filter corner frequency (-3 dB), flatness (-1 dB), Q-factor (or peaking), and channel-to-channel delay have wide variations. These variances can lead to potential performance and quality issues in mass-production environments. The THS7320 solves most of these problems with the corner frequency being essentially the only variable.

Another concern about passive filters is the use of inductors. Inductors are magnetic components, and are therefore susceptible to electromagnetic coupling/interference (EMC/EMI). Some common coupling can occur because of other video channels nearby using inductors for filtering, or it can come from nearby switched-mode power supplies. Some other forms of coupling could be from outside sources with strong EMI radiation and can cause failure in EMC testing such as required for CE compliance.

One concern about an active filter in an integrated circuit is the variation of the filter characteristics when the ambient temperature and the subsequent die temperature change. To minimize temperature effects, the THS7320 uses low-temperature coefficient resistors and high-quality, low-temperature coefficient capacitors found in the BiCom3X process. These filters have been specified by design to account for process variations and temperature variations to maintain proper filter characteristics. This approach maintains a low channel-to-channel time delay that is required for proper video signal performance.

Another benefit of the THS7320 over a passive RLC filter are the input and output impedances. With a passive filter, the input impedance presented to the DAC varies significantly, from $35\ \Omega$ to over $1.5\ \text{k}\Omega$, and may cause voltage variations over frequency. The THS7320 input impedance is $2.4\ \text{M}\Omega$, and only the 2-pF input capacitance plus the PCB trace capacitance impact the input impedance. As such, the voltage variation appearing at the DAC output is better controlled with a fixed termination resistor and the high input impedance buffer of the THS7320.

On the output side of the filter, a passive filter again has a large impedance variation over frequency. The EIA770 specifications require the return loss to be at least $25\ \text{dB}$ over the video frequency range of use. For a video system, this requirement implies that the source impedance (which includes the source, series resistor, and the filter) must be better than $75\ \Omega$, $+9\ \Omega/-8\ \Omega$. The THS7320 is an operational amplifier that approximates an ideal voltage source, which is desirable because the output impedance is very low and can source and sink current. To properly match the transmission line characteristic impedance of a video line, a $75\text{-}\Omega$ series resistor is placed on the output. To minimize reflections and to maintain a good return loss meeting EIA specifications, this output impedance must maintain a $75\text{-}\Omega$ impedance. A wide impedance variation of a passive filter cannot ensure this level of performance. On the other hand, the THS7320 has approximately $1.4\ \Omega$ of output impedance, or a return loss of $41\ \text{dB}$, at $11\ \text{MHz}$. Thus, the system is matched significantly better with a THS7320 compared to a passive filter.

One final benefit of the THS7320 over a passive filter is power dissipation. A DAC driving a video line must be able to drive a $37.5\text{-}\Omega$ load: the receiver $75\text{-}\Omega$ resistor and the $75\text{-}\Omega$ impedance matching resistor next to the DAC to maintain the source impedance requirement. This requirement forces the DAC to drive at least $1.25\ \text{V}_P$ (100% saturation CVBS)/ $37.5\ \Omega = 33.3\ \text{mA}$. A DAC is a current-steering element, and this amount of current flows internally to the DAC even if the output is $0\ \text{V}$. Thus, power dissipation in the DAC may be very high, especially when three channels are being driven.

Using the THS7320 with a high input impedance can reduce DAC power dissipation significantly. This outcome is possible because the resistance that the DAC drives can be substantially increased. It is common to set this resistance in a DAC by a current-setting resistor on the DAC itself. Thus, the resistance can be $300\ \Omega$ or more, substantially reducing the current drive demands from the DAC and saving significant amounts of power. For example, a 3.3-V , three-channel DAC dissipates $330\ \text{mW}$ alone for the steering current capability (three channels $\times 33.3\ \text{mA} \times 3.3\ \text{V}$) if it must drive a $37.5\text{-}\Omega$ load. With a $300\text{-}\Omega$ load, the DAC power dissipation as a result of current steering current would only be $41\ \text{mW}$ (three channels $\times 4.16\ \text{mA} \times 3.3\ \text{V}$), or over eight times lower power. For overall system power, this scenario must also account for the THS7320 power. The THS7320 only consumes 3.4-mA total quiescent current. The quiescent power added is then $3.3\ \text{V} \times 3.4\ \text{mA} = 11.2\ \text{mW}$. The total system power is then $41\ \text{mW} + 11\ \text{mW} = 52\ \text{mW}$, or a factor of six times lower power compared to the DAC driving the line directly. Saving power by adding the THS7320 in a system is easy to see and accomplish, not to mention that it incorporates the added benefit of a three-pole filter on each channel.

EVALUATION MODULE

To evaluate the THS7320, an evaluation module (EVM) is available. The EVM allows dc-coupled input and output configurations. Inputs and outputs include BNC connectors commonly found in video systems along with 75- Ω effective input termination resistors, 75- Ω series source termination resistors, and 75- Ω characteristic impedance traces. This EVM is designed to be used with a single supply from 2.6 V up to 5 V.

The EVM input configuration sets all channels for dc input coupling. The input signal must be within 0 V to approximately 0.75 V for proper operation. Failure to be within this range saturates and/or clips the output signal. Refer to the [Application Information](#) section for further information.

The THS7320 incorporates an easy method to configure the enable mode. JP1 controls the enable feature. Connecting JP1 to GND applies 0 V to the enable pin and the THS7320 is placed into shutdown mode consuming nominally 0.15 μ A of quiescent current. Moving JP1 to +V_S causes the THS7320 to be in normal operation mode where the quiescent current should be nominally 3.4 mA for the entire EVM. This quiescent current is with no load or no signal applied on the input. Adding a load or input signal causes the quiescent current to vary accordingly.

An example procedure to confirm proper device operation with standard lab equipment is described in the following sections.

REQUIRED EQUIPMENT

- One dc power supply: +3.0 V, 50-mA output (minimum) is recommended
- One dc current meter: resolution to 1 mA, capable of maximum current the dc power supply can supply
- Function or arbitrary waveform generator
- Oscilloscope: 50-MHz bandwidth (minimum) is recommended
- Banana-to-banana patch cords
- BNC test cables

BASIC SETUP

1. Set the dc power supply to +3.0 V. Set the current limit on the dc power supply to 50 mA.
2. Connect the positive (+) terminal of the power supply to the positive (+) terminal of the current meter.
3. Connect the negative (–) terminal of the current meter to the V_{S+} terminal of the EVM (J7).
4. Connect the common ground terminal of the power supply to the ground (GND) terminal on the EVM (J8).
5. Connect the output of the waveform generator to the channel 1 input on the EVM (J1)
6. Connect the probe ground to the GND of the EVM.

TESTING THE EVM

The EVM can be tested by following these steps:

1. Enable the 3.0-V_{DC} power supply.
2. Verify that the current meter is reading nominally 3.5 mA (2.7 mA to 4.7 mA, minimum and maximum).
3. Set the function generator such that a 1-MHz, 0.5-V_{PP} sine wave (with an 0.40-V_{DC} offset) appears on the THS7320 input pin. The function generator ac and dc levels may have to be adjusted to ensure the proper voltage appears on the THS7320 input pins because most function generators have a 50- Ω source impedance and the THS7320 incorporates a double 37.4- Ω resistor termination divider scheme for a total 75- Ω termination.
4. Probe the device side of R12, which is connected to the THS7320 channel 1 output pin.
5. Verify that the oscilloscope displays the THS7320 channel 1 output voltage amplitude as 2.0 V_{PP} \pm 0.1 V with a nominal 1.75-V_{DC} offset.
6. Repeat steps 3 through 5 for channels 2 and 3.
7. When confirmed, turn off the function generator and power supply.
8. Note that if video equipment is used with the THS7320EVM, the proper input and output 75- Ω terminations already exist on the EVM along with the proper input voltage divider. This functionality makes the EVM very easy to test video signals with no modifications to the EVM.

Figure 59 shows the EVM schematic. Figure 60 through Figure 63 illustrate the layers of the EVM PCB, incorporating standard high-speed layout practices. Table 5 lists the bill of materials as the board comes supplied from Texas Instruments.

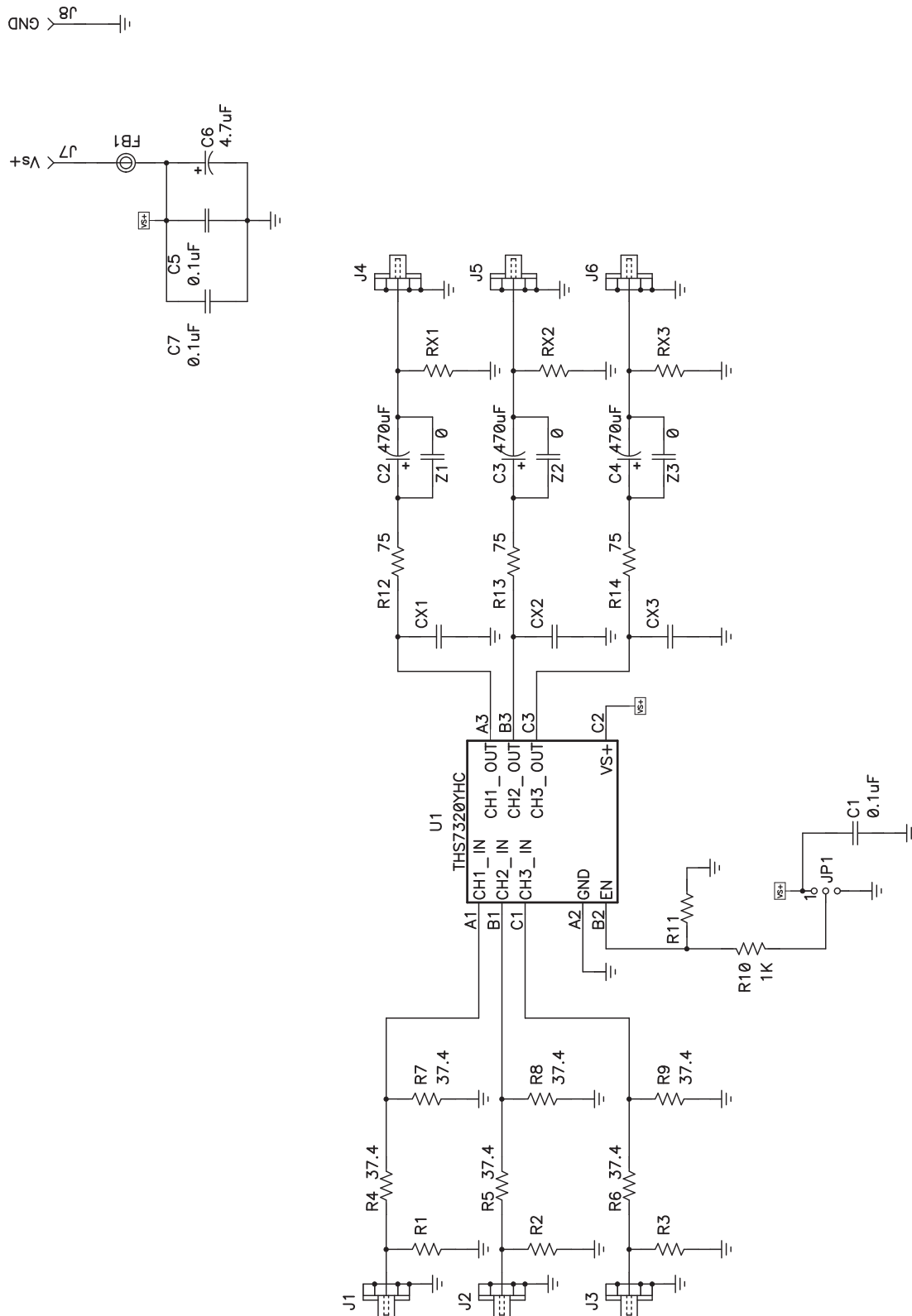

Figure 59. THS7320 EVM Schematic

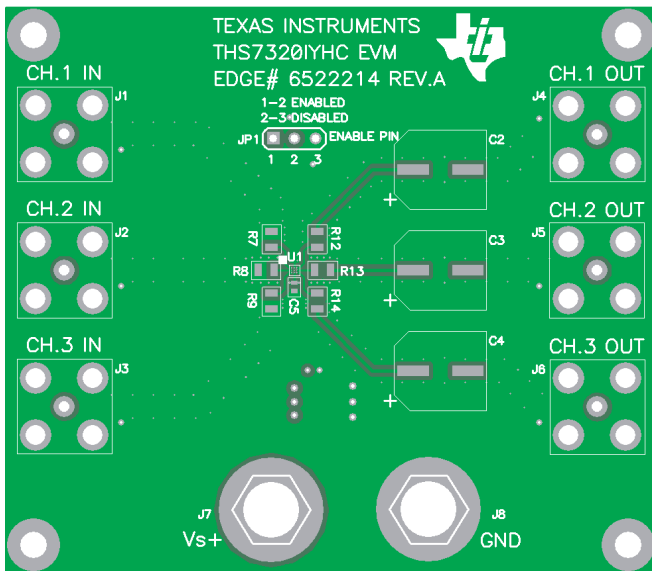

Figure 60. THS7320 EVM PCB Top Layer

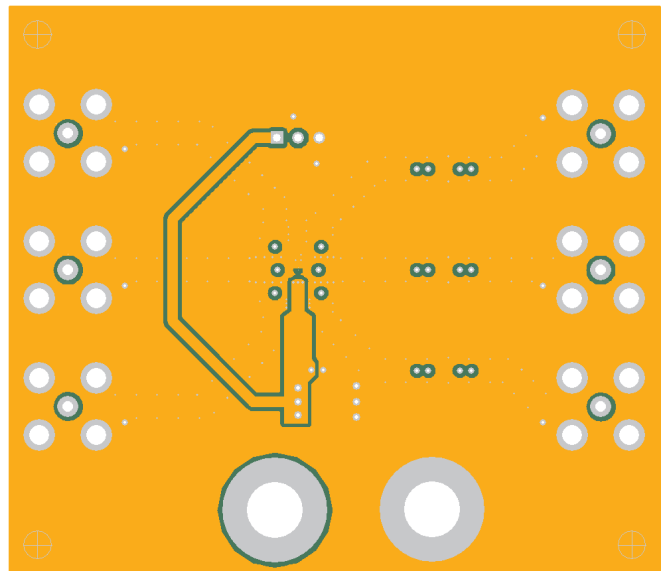

Figure 61. THS7320 EVM PCB Layer 2

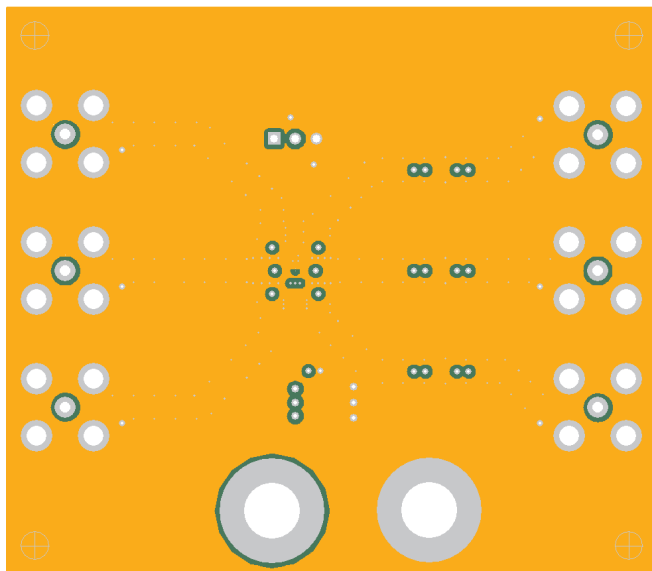

Figure 62. THS7320 EVM PCB Layer 3

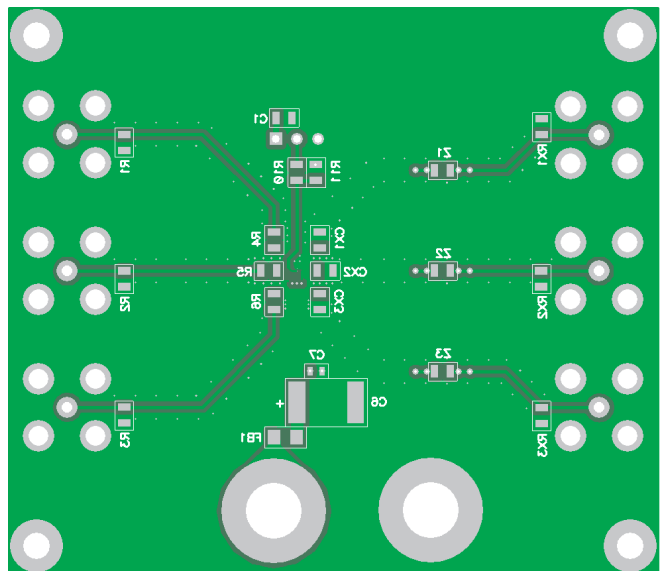

Figure 63. THS7320 EVM PCB Bottom Layer

THS7320IYHC EVM Bill of Materials

Table 5. THS7320 EVM

| ITEM | REF DES | QTY | DESCRIPTION | SMD SIZE | MANUFACTURER PART NUMBER | DISTRIBUTOR PART NUMBER |
|------|---------------------|-----|--|----------|---------------------------|---------------------------|
| 1 | FB1 | 1 | Bead, ferrite, 2.5 A, 330 Ω | 0805 | (TDK) MPZ2012S331A | (Digi-Key) 445-1569-1-ND |
| 2 | C6 | 1 | Capacitor, 4.7 μF, tantalum, 35V, 10%, low ESR | C | (AVX) TPSC475K035R0600 | (Digi-Key) 478-1772-1-ND |
| 3 | CX1-CX3 | 3 | Open | 0805 | — | — |
| 4 | C5 | 1 | Capacitor, 0.1 μF, ceramic, 16V, X7R | 0402 | (TDK) C1005X7R1C104K | (Digi-Key) 445-4952-1-ND |
| 5 | C7 | 1 | Capacitor, 0.1 μF, ceramic, 16V, X7R | 0603 | (AVX) 0603YC104KAT2A | (Digi-Key) 478-1239-1-ND |
| 6 | C1 | 1 | Capacitor, 0.1 μF, ceramic, 50V, X7R | 0805 | (AVX) 08055C104KAT2A | (Digi-Key) 478-1395-1-ND |
| 7 | C2-C4 | 3 | Capacitor, aluminum, 470 μF, 10V, 20% | F | (Panasonic) EEE-FP1A471AP | (Digi-Key) PCE4526CT-ND |
| 8 | R1-R3, R11, RX1-RX3 | 7 | Open | 0805 | — | — |
| 9 | Z1-Z3 | 3 | Resistor, 0 Ω, 1/8W | 0805 | (ROHM) MCR10EZPJ000 | (Digi-Key) RHM0.0ARCT-ND |
| 10 | R4-R9 | 6 | Resistor, 37.4 Ω, 1/8W, 1% | 0805 | (ROHM) MCR10EZHF37R4 | (Digi-Key) RHM37.4CCT-ND |
| 11 | R12-R14 | 3 | Resistor, 75 Ω, 1/8W, 1% | 0805 | (ROHM) MCR10EZHF75.0 | (Digi-Key) RHM75.0CCT-ND |
| 12 | R10 | 1 | Resistor, 1 kΩ, 1/8W, 1% | 0805 | (ROHM) MCR10EZHF1001 | (Digi-Key) RHM1.00KCCT-ND |
| 13 | J7, J8 | 2 | Jack, banana receptance, 0.25" dia. hole | — | (SPC) 15459 | (Newark) 79K5034 |
| 14 | J1-J6 | 6 | Connector, BNC, jack, 75 Ω | — | (Amphenol) 31-5329-72RFX | (Newark) 93F7554 |
| 15 | JP1 | 1 | Header, 0.1" CTRS, 0.025" sq. pins | 3 POS. | (Sullins) PBC36SAAN | (Digi-Key) S1011E-36-ND |
| 16 | JP1 | 1 | Shunts | — | (Sullins) SSC02SYAN | (Digi-Key) S9002-ND |
| 17 | U1 | 1 | IC, THS7320 | YHC | (TI) THS7320IYHC | — |
| 18 | — | 4 | Standoff, 4-40 HEX, 0.625" length | — | (Keystone) 1808 | (Digi-Key) 1808K-ND |
| 19 | — | 4 | Screw, Phillips, 4-40, 0.250" | — | PMSSS 440 0025 PH | (Digi-Key) H703-ND |
| 20 | — | 1 | Board, printed circuit | — | EDGE # 6522214 REV.A | — |

REVISION HISTORY

NOTE: Page numbers for previous revisions may differ from page numbers in the current version.

Changes from Revision A (August 2012) to Revision B Page

- Added the *Required Equipment*, *Basic Setup*, and *Testing the EVM* sections [27](#)

Changes from Original (July 2011) to Revision A Page

- Added THS7320IYHCT row to Package/Ordering Information table [2](#)

EVALUATION BOARD/KIT IMPORTANT NOTICE

Texas Instruments (TI) provides the enclosed product(s) under the following conditions:

This evaluation board/kit is intended for use for **ENGINEERING DEVELOPMENT, DEMONSTRATION, OR EVALUATION PURPOSES ONLY** and is not considered by TI to be a finished end-product fit for general consumer use. Persons handling the product(s) must have electronics training and observe good engineering practice standards. As such, the goods being provided are not intended to be complete in terms of required design-, marketing-, and/or manufacturing-related protective considerations, including product safety and environmental measures typically found in end products that incorporate such semiconductor components or circuit boards. This evaluation board/kit does not fall within the scope of the European Union directives regarding electromagnetic compatibility, restricted substances (RoHS), recycling (WEEE), FCC, CE or UL, and therefore may not meet the technical requirements of these directives or other related directives.

Should this evaluation board/kit not meet the specifications indicated in the User's Guide, the board/kit may be returned within 30 days from the date of delivery for a full refund. **THE FOREGOING WARRANTY IS THE EXCLUSIVE WARRANTY MADE BY SELLER TO BUYER AND IS IN LIEU OF ALL OTHER WARRANTIES, EXPRESSED, IMPLIED, OR STATUTORY, INCLUDING ANY WARRANTY OF MERCHANTABILITY OR FITNESS FOR ANY PARTICULAR PURPOSE.**

The user assumes all responsibility and liability for proper and safe handling of the goods. Further, the user indemnifies TI from all claims arising from the handling or use of the goods. Due to the open construction of the product, it is the user's responsibility to take any and all appropriate precautions with regard to electrostatic discharge.

EXCEPT TO THE EXTENT OF THE INDEMNITY SET FORTH ABOVE, NEITHER PARTY SHALL BE LIABLE TO THE OTHER FOR ANY INDIRECT, SPECIAL, INCIDENTAL, OR CONSEQUENTIAL DAMAGES.

TI currently deals with a variety of customers for products, and therefore our arrangement with the user **is not exclusive**.

TI assumes **no liability for applications assistance, customer product design, software performance, or infringement of patents or services described herein.**

Please read the User's Guide and, specifically, the Warnings and Restrictions notice in the User's Guide prior to handling the product. This notice contains important safety information about temperatures and voltages. For additional information on TI's environmental and/or safety programs, please contact the TI application engineer or visit www.ti.com/esh.

No license is granted under any patent right or other intellectual property right of TI covering or relating to any machine, process, or combination in which such TI products or services might be or are used.

FCC Warning

This evaluation board/kit is intended for use for **ENGINEERING DEVELOPMENT, DEMONSTRATION, OR EVALUATION PURPOSES ONLY** and is not considered by TI to be a finished end-product fit for general consumer use. It generates, uses, and can radiate radio frequency energy and has not been tested for compliance with the limits of computing devices pursuant to part 15 of FCC rules, which are designed to provide reasonable protection against radio frequency interference. Operation of this equipment in other environments may cause interference with radio communications, in which case the user at his own expense will be required to take whatever measures may be required to correct this interference.

EVM WARNINGS AND RESTRICTIONS

It is important to operate this EVM within the input voltage range of 1.6 V to 5.5 V and the output voltage range of 0 V to 5.5 V.

Exceeding the specified input range may cause unexpected operation and/or irreversible damage to the EVM. If there are questions concerning the input range, please contact a TI field representative prior to connecting the input power.

Applying loads outside of the specified output range may result in unintended operation and/or possible permanent damage to the EVM. Please consult the EVM User's Guide prior to connecting any load to the EVM output. If there is uncertainty as to the load specification, please contact a TI field representative.

During normal operation, some circuit components may have case temperatures greater than +85°C. The EVM is designed to operate properly with certain components above +85°C as long as the input and output ranges are maintained. These components include but are not limited to linear regulators, switching transistors, pass transistors, and current sense resistors. These types of devices can be identified using the EVM schematic located in the EVM User's Guide. When placing measurement probes near these devices during operation, please be aware that these devices may be very warm to the touch.

Mailing Address: Texas Instruments, Post Office Box 655303, Dallas, Texas 75265
Copyright © 2009, Texas Instruments Incorporated

PACKAGING INFORMATION

| Orderable Device | Status (1) | Package Type | Package Drawing | Pins | Package Qty | Eco Plan (2) | Lead/Ball Finish | MSL Peak Temp (3) | Op Temp (°C) | Top-Side Markings (4) | Samples |
|------------------|---------------|--------------|-----------------|------|-------------|-------------------------|------------------|----------------------|--------------|--------------------------|-------------------------|
| THS7320IYHCR | ACTIVE | DSBGA | YHC | 9 | 3000 | Green (RoHS & no Sb/Br) | SNAGCU | Level-1-260C-UNLIM | -40 to 85 | QJK | Samples |
| THS7320IYHCT | ACTIVE | DSBGA | YHC | 9 | 250 | Green (RoHS & no Sb/Br) | SNAGCU | Level-1-260C-UNLIM | -40 to 85 | QJK | Samples |

(1) The marketing status values are defined as follows:

ACTIVE: Product device recommended for new designs.

LIFEBUY: TI has announced that the device will be discontinued, and a lifetime-buy period is in effect.

NRND: Not recommended for new designs. Device is in production to support existing customers, but TI does not recommend using this part in a new design.

PREVIEW: Device has been announced but is not in production. Samples may or may not be available.

OBSOLETE: TI has discontinued the production of the device.

(2) Eco Plan - The planned eco-friendly classification: Pb-Free (RoHS), Pb-Free (RoHS Exempt), or Green (RoHS & no Sb/Br) - please check <http://www.ti.com/productcontent> for the latest availability information and additional product content details.

TBD: The Pb-Free/Green conversion plan has not been defined.

Pb-Free (RoHS): TI's terms "Lead-Free" or "Pb-Free" mean semiconductor products that are compatible with the current RoHS requirements for all 6 substances, including the requirement that lead not exceed 0.1% by weight in homogeneous materials. Where designed to be soldered at high temperatures, TI Pb-Free products are suitable for use in specified lead-free processes.

Pb-Free (RoHS Exempt): This component has a RoHS exemption for either 1) lead-based flip-chip solder bumps used between the die and package, or 2) lead-based die adhesive used between the die and leadframe. The component is otherwise considered Pb-Free (RoHS compatible) as defined above.

Green (RoHS & no Sb/Br): TI defines "Green" to mean Pb-Free (RoHS compatible), and free of Bromine (Br) and Antimony (Sb) based flame retardants (Br or Sb do not exceed 0.1% by weight in homogeneous material)

(3) MSL, Peak Temp. -- The Moisture Sensitivity Level rating according to the JEDEC industry standard classifications, and peak solder temperature.

(4) Multiple Top-Side Markings will be inside parentheses. Only one Top-Side Marking contained in parentheses and separated by a "~" will appear on a device. If a line is indented then it is a continuation of the previous line and the two combined represent the entire Top-Side Marking for that device.

Important Information and Disclaimer: The information provided on this page represents TI's knowledge and belief as of the date that it is provided. TI bases its knowledge and belief on information provided by third parties, and makes no representation or warranty as to the accuracy of such information. Efforts are underway to better integrate information from third parties. TI has taken and continues to take reasonable steps to provide representative and accurate information but may not have conducted destructive testing or chemical analysis on incoming materials and chemicals. TI and TI suppliers consider certain information to be proprietary, and thus CAS numbers and other limited information may not be available for release.

In no event shall TI's liability arising out of such information exceed the total purchase price of the TI part(s) at issue in this document sold by TI to Customer on an annual basis.

TAPE AND REEL INFORMATION



QUADRANT ASSIGNMENTS FOR PIN 1 ORIENTATION IN TAPE



*All dimensions are nominal

| Device | Package Type | Package Drawing | Pins | SPQ | Reel Diameter (mm) | Reel Width W1 (mm) | A0 (mm) | B0 (mm) | K0 (mm) | P1 (mm) | W (mm) | Pin1 Quadrant |
|--------------|--------------|-----------------|------|------|--------------------|--------------------|---------|---------|---------|---------|--------|---------------|
| THS7320IYHCR | DSBGA | YHC | 9 | 3000 | 180.0 | 8.4 | 1.06 | 1.06 | 0.56 | 4.0 | 8.0 | Q1 |
| THS7320IYHCT | DSBGA | YHC | 9 | 250 | 180.0 | 8.4 | 1.06 | 1.06 | 0.56 | 4.0 | 8.0 | Q1 |

TAPE AND REEL BOX DIMENSIONS

*All dimensions are nominal

| Device | Package Type | Package Drawing | Pins | SPQ | Length (mm) | Width (mm) | Height (mm) |
|--------------|--------------|-----------------|------|------|-------------|------------|-------------|
| THS7320IYHCR | DSBGA | YHC | 9 | 3000 | 182.0 | 182.0 | 20.0 |
| THS7320IYHCT | DSBGA | YHC | 9 | 250 | 182.0 | 182.0 | 20.0 |

YHC (S-XBGA-N9)

DIE-SIZE BALL GRID ARRAY

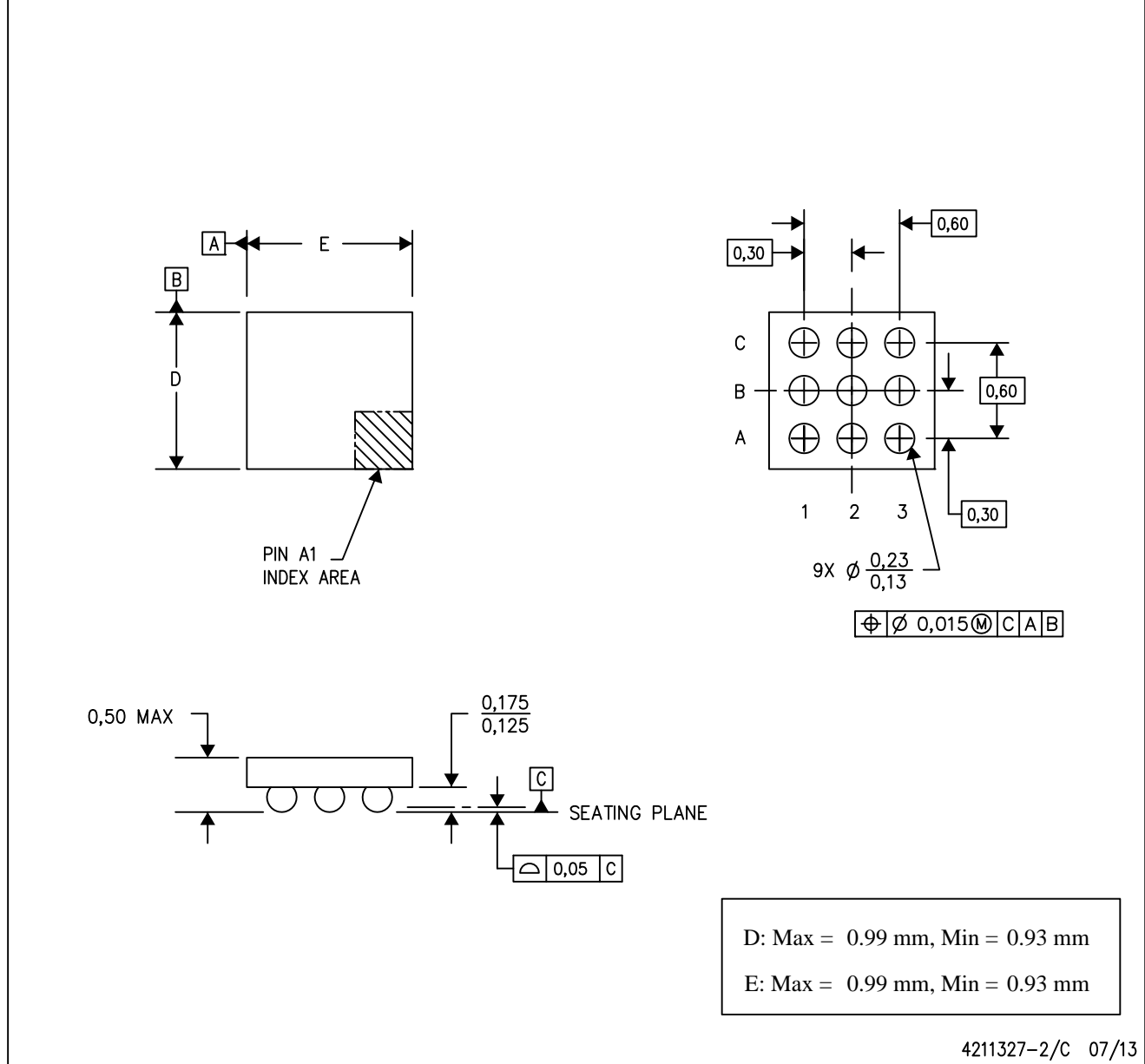

- NOTES: A. All linear dimensions are in millimeters. Dimensioning and tolerancing per ASME Y14.5M-1994.
 B. This drawing is subject to change without notice.
 C. NanoFree™ package configuration.

NanoFree is a trademark of Texas Instruments.

IMPORTANT NOTICE

Texas Instruments Incorporated (TI) reserves the right to make corrections, enhancements, improvements and other changes to its semiconductor products and services per JESD46, latest issue, and to discontinue any product or service per JESD48, latest issue. Buyers should obtain the latest relevant information before placing orders and should verify that such information is current and complete.

TI's published terms of sale for semiconductor products (<http://www.ti.com/sc/docs/stdterms.htm>) apply to the sale of packaged integrated circuit products that TI has qualified and released to market. Additional terms may apply to the use or sale of other types of TI products and services.

Reproduction of significant portions of TI information in TI data sheets is permissible only if reproduction is without alteration and is accompanied by all associated warranties, conditions, limitations, and notices. TI is not responsible or liable for such reproduced documentation. Information of third parties may be subject to additional restrictions. Resale of TI products or services with statements different from or beyond the parameters stated by TI for that product or service voids all express and any implied warranties for the associated TI product or service and is an unfair and deceptive business practice. TI is not responsible or liable for any such statements.

Buyers and others who are developing systems that incorporate TI products (collectively, "Designers") understand and agree that Designers remain responsible for using their independent analysis, evaluation and judgment in designing their applications and that Designers have full and exclusive responsibility to assure the safety of Designers' applications and compliance of their applications (and of all TI products used in or for Designers' applications) with all applicable regulations, laws and other applicable requirements. Designer represents that, with respect to their applications, Designer has all the necessary expertise to create and implement safeguards that (1) anticipate dangerous consequences of failures, (2) monitor failures and their consequences, and (3) lessen the likelihood of failures that might cause harm and take appropriate actions. Designer agrees that prior to using or distributing any applications that include TI products, Designer will thoroughly test such applications and the functionality of such TI products as used in such applications.

TI's provision of technical, application or other design advice, quality characterization, reliability data or other services or information, including, but not limited to, reference designs and materials relating to evaluation modules, (collectively, "TI Resources") are intended to assist designers who are developing applications that incorporate TI products; by downloading, accessing or using TI Resources in any way, Designer (individually or, if Designer is acting on behalf of a company, Designer's company) agrees to use any particular TI Resource solely for this purpose and subject to the terms of this Notice.

TI's provision of TI Resources does not expand or otherwise alter TI's applicable published warranties or warranty disclaimers for TI products, and no additional obligations or liabilities arise from TI providing such TI Resources. TI reserves the right to make corrections, enhancements, improvements and other changes to its TI Resources. TI has not conducted any testing other than that specifically described in the published documentation for a particular TI Resource.

Designer is authorized to use, copy and modify any individual TI Resource only in connection with the development of applications that include the TI product(s) identified in such TI Resource. NO OTHER LICENSE, EXPRESS OR IMPLIED, BY ESTOPPEL OR OTHERWISE TO ANY OTHER TI INTELLECTUAL PROPERTY RIGHT, AND NO LICENSE TO ANY TECHNOLOGY OR INTELLECTUAL PROPERTY RIGHT OF TI OR ANY THIRD PARTY IS GRANTED HEREIN, including but not limited to any patent right, copyright, mask work right, or other intellectual property right relating to any combination, machine, or process in which TI products or services are used. Information regarding or referencing third-party products or services does not constitute a license to use such products or services, or a warranty or endorsement thereof. Use of TI Resources may require a license from a third party under the patents or other intellectual property of the third party, or a license from TI under the patents or other intellectual property of TI.

TI RESOURCES ARE PROVIDED "AS IS" AND WITH ALL FAULTS. TI DISCLAIMS ALL OTHER WARRANTIES OR REPRESENTATIONS, EXPRESS OR IMPLIED, REGARDING RESOURCES OR USE THEREOF, INCLUDING BUT NOT LIMITED TO ACCURACY OR COMPLETENESS, TITLE, ANY EPIDEMIC FAILURE WARRANTY AND ANY IMPLIED WARRANTIES OF MERCHANTABILITY, FITNESS FOR A PARTICULAR PURPOSE, AND NON-INFRINGEMENT OF ANY THIRD PARTY INTELLECTUAL PROPERTY RIGHTS. TI SHALL NOT BE LIABLE FOR AND SHALL NOT DEFEND OR INDEMNIFY DESIGNER AGAINST ANY CLAIM, INCLUDING BUT NOT LIMITED TO ANY INFRINGEMENT CLAIM THAT RELATES TO OR IS BASED ON ANY COMBINATION OF PRODUCTS EVEN IF DESCRIBED IN TI RESOURCES OR OTHERWISE. IN NO EVENT SHALL TI BE LIABLE FOR ANY ACTUAL, DIRECT, SPECIAL, COLLATERAL, INDIRECT, PUNITIVE, INCIDENTAL, CONSEQUENTIAL OR EXEMPLARY DAMAGES IN CONNECTION WITH OR ARISING OUT OF TI RESOURCES OR USE THEREOF, AND REGARDLESS OF WHETHER TI HAS BEEN ADVISED OF THE POSSIBILITY OF SUCH DAMAGES.

Unless TI has explicitly designated an individual product as meeting the requirements of a particular industry standard (e.g., ISO/TS 16949 and ISO 26262), TI is not responsible for any failure to meet such industry standard requirements.

Where TI specifically promotes products as facilitating functional safety or as compliant with industry functional safety standards, such products are intended to help enable customers to design and create their own applications that meet applicable functional safety standards and requirements. Using products in an application does not by itself establish any safety features in the application. Designers must ensure compliance with safety-related requirements and standards applicable to their applications. Designer may not use any TI products in life-critical medical equipment unless authorized officers of the parties have executed a special contract specifically governing such use. Life-critical medical equipment is medical equipment where failure of such equipment would cause serious bodily injury or death (e.g., life support, pacemakers, defibrillators, heart pumps, neurostimulators, and implantables). Such equipment includes, without limitation, all medical devices identified by the U.S. Food and Drug Administration as Class III devices and equivalent classifications outside the U.S.

TI may expressly designate certain products as completing a particular qualification (e.g., Q100, Military Grade, or Enhanced Product). Designers agree that it has the necessary expertise to select the product with the appropriate qualification designation for their applications and that proper product selection is at Designers' own risk. Designers are solely responsible for compliance with all legal and regulatory requirements in connection with such selection.

Designer will fully indemnify TI and its representatives against any damages, costs, losses, and/or liabilities arising out of Designer's non-compliance with the terms and provisions of this Notice.