

2-W FILTERLESS STEREO CLASS-D AUDIO POWER AMPLIFIER

FEATURES

- Modulation Scheme Optimized to Operate Without a Filter
- 2 W Into 3-Ω Speakers (THD+N < 0.4%)
- < 0.08% THD+N at 1 W, 1 kHz, Into 4-Ω Load
- Extremely Efficient Third Generation 5-V Class-D Technology:
 - Low Supply Current (No Filter) ... 8 mA
 - Low Supply Current (Filter) ... 15 mA
 - Low Shutdown Current ... 1 μA
 - Low Noise Floor ... 56 μV_{RMS}
 - Maximum Efficiency Into 3 Ω, 65-70%
 - Maximum Efficiency Into 8 Ω, 75-85%
 - 4 Internal Gain Settings ... 8-23.5 dB
 - PSRR ... -77 dB
- Integrated Depop Circuitry

- Short-Circuit Protection (Short to Battery, Ground, and Load)
- -40°C to 85°C Operating Temperature Range

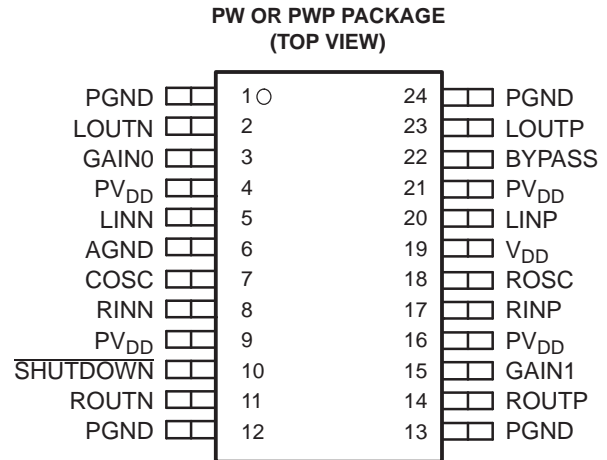

DESCRIPTION

The TPA2000D2 is the third generation 5-V class-D amplifier from Texas Instruments. Improvements to previous generation devices include: lower supply current, lower noise floor, better efficiency, four different gain settings, smaller packaging, and fewer external components. The most significant advancement with this device is its modulation scheme that allows the amplifier to operate without the output filter. Eliminating the output filter saves the user approximately 30% in system cost and 75% in PCB area.

The TPA2000D2 is a monolithic class-D power IC stereo audio amplifier, using the high switching speed of power MOSFET transistors. These transistors reproduce the analog signal through high-frequency switching of the output stage. The TPA2000D2 is configured as a bridge-tied load (BTL) amplifier capable of delivering greater than 2 W of continuous average power into a 3-Ω load at less than 1% THD+N from a 5-V power supply in the high fidelity range (20 Hz to 20 kHz). With 1 W being delivered to a 4-Ω load at 1 kHz, the typical THD+N is less than 0.08%.

A BTL configuration eliminates the need for external coupling capacitors on the output. Low supply current of 8 mA makes the device ideal for battery-powered applications. Protection circuitry increases device reliability: thermal, over-current, and under-voltage shutdown.

Efficient class-D modulation enables the TPA2000D2 to operate at full power into 3-Ω loads at an ambient temperature of 85°C.

AVAILABLE OPTIONS⁽¹⁾

T _A	PACKAGED DEVICE	
	TSSOP (PW)	TSSOP (PWP) ⁽²⁾
-40°C to 85°C	TPA2000D2PW	TPA2000D2PWP

- (1) For the most current package and ordering information, see the Package Option Addendum at the end of this document, or see the TI web site at www.ti.com.
- (2) The PWP package is available taped and reeled. To order a taped and reeled part, add the suffix R to the part number (e.g., TPA2000D2PWPR).



Please be aware that an important notice concerning availability, standard warranty, and use in critical applications of Texas Instruments semiconductor products and disclaimers thereto appears at the end of this data sheet.



These devices have limited built-in ESD protection. The leads should be shorted together or the device placed in conductive foam during storage or handling to prevent electrostatic damage to the MOS gates.

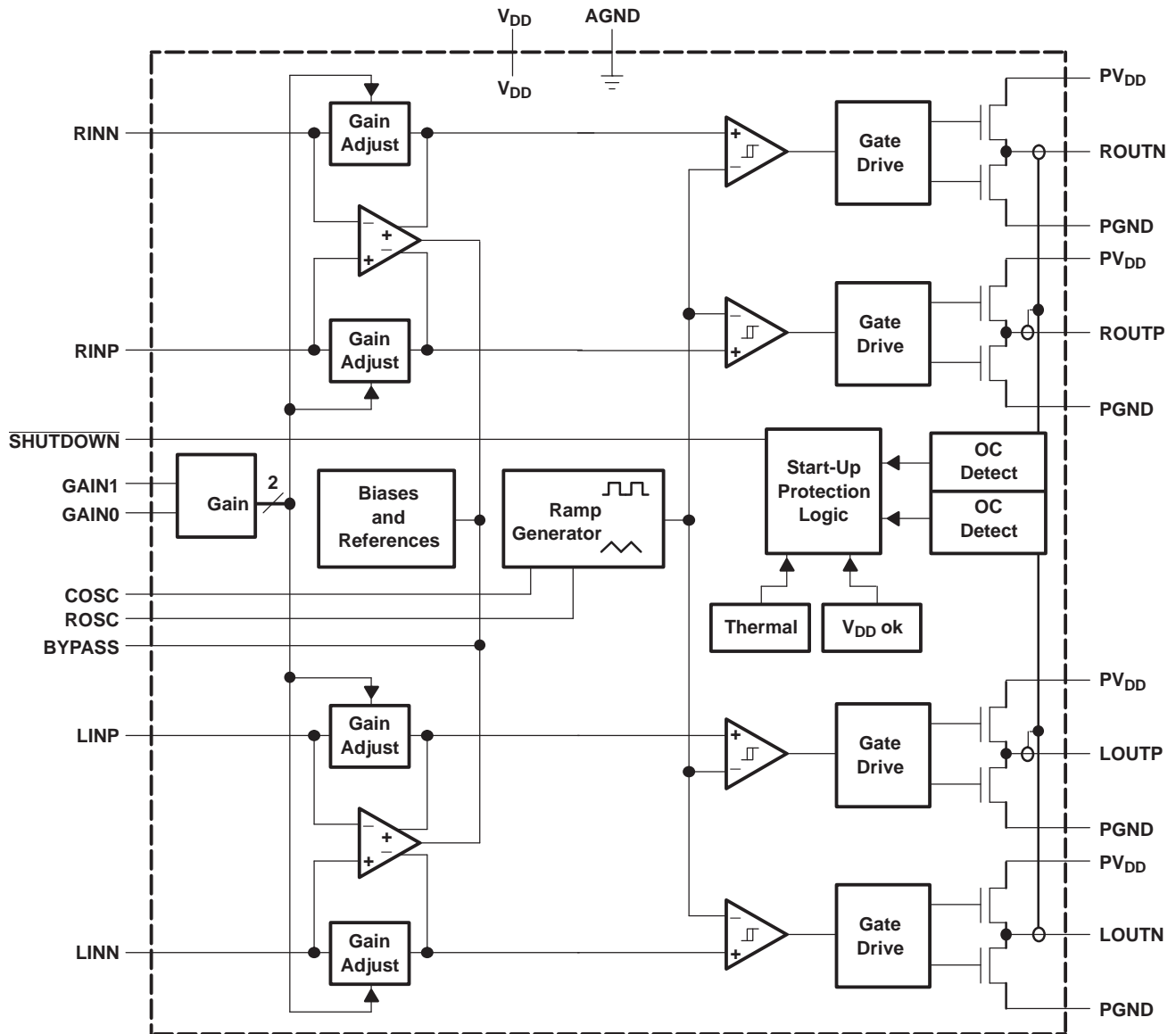

TERMINAL FUNCTION

TERMINAL NAME	NO.	I/O	DESCRIPTION
AGND	6	-	Analog ground
BYPASS	22	I	Tap to voltage divider for internal midsupply bias generator used for analog reference.
COSC	7	I	A capacitor connected to this terminal sets the oscillation frequency in conjunction with ROSC. For proper operation, connect a 220 pF capacitor from COSC to ground.
GAIN0	3	I	Bit 0 of gain control (TTL logic level)
GAIN1	15	I	Bit 1 of gain control (TTL logic level)
LINN	5	I	Left channel negative differential audio input
LINP	20	I	Left channel positive differential audio input
LOUTN	2	O	Left channel negative audio output
LOUTP	23	O	Left channel positive audio output
PGND	1, 24	-	Power ground for left channel H-bridge
	12, 13	-	Power ground for right channel H-bridge
PV _{DD}	4, 21	-	Power supply for left channel H-bridge
	9, 16	-	Power supply for right channel H-bridge
RINN	8	I	Right channel negative differential audio input
RINP	17	I	Right channel positive differential audio input
ROSC	18	I	A resistor connected to this terminal sets the oscillation frequency in conjunction with COSC. For proper operation, connect a 120 kΩ resistor from ROSC to ground.
ROUTN	11	O	Right channel negative audio output
ROUTP	14	O	Right channel positive output
SHUTDOWN	10	I	Places the amplifier in shutdown mode if a TTL logic low is placed on this terminal; normal operation if a TTL logic high is placed on this terminal.
V _{DD}	19	-	Analog power supply

ABSOLUTE MAXIMUM RATINGS

over operating free-air temperature range (unless otherwise noted)⁽¹⁾

		UNIT
V _{DD} , PV _{DD}	Supply voltage	-0.3 V to 6 V
V _I	Input voltage	-0.3 V to V _{DD} +0.3 V
	Continuous total power dissipation	See Dissipation Rating Table
T _A	Operating free-air temperature range	-40°C to 85°C
T _J	Operating junction temperature range	-40°C to 150°C
T _{stg}	Storage temperature range	-65°C to 150°C
	Lead temperature 1,6 mm (1/16 inch) from case for 10 seconds	260°C

(1) Stresses beyond those listed under absolute maximum ratings may cause permanent damage to the device. These are stress ratings only, and functional operation of the device at these or any other conditions beyond those indicated under recommended operating conditions is not implied. Exposure to absolute-maximum-rated conditions for extended periods may affect device reliability.

DISSIPATION RATING TABLE

PACKAGE	T _A ≤ 25°C POWER RATING	DERATING FACTOR ABOVE T _A = 25°C	T _A = 70°C POWER RATING	T _A = 85°C POWER RATING
PW	1.04 W	8.34 mW/°C	0.67 W	0.54 W
PWP	2.7 W	21.8 mW/°C	1.7 W	1.4 W

RECOMMENDED OPERATING CONDITIONS

		MIN	TYP	MAX	UNIT
V _{DD} , PV _{DD}	Supply voltage	4.5		5.5	V
V _{IH}	High-level input voltage	GAIN0, GAIN1, SHUTDOWN		2	V
V _{IL}	Low-level input voltage	GAIN0, GAIN1, SHUTDOWN		0.8	V
R _{OSC}	Oscillator resistance		120		kΩ
C _{OSC}	Oscillator capacitance		220		pF
f _s	Switching frequency	200		300	kHz
T _A	Operating free-air temperature	-40		85	°C

ELECTRICAL CHARACTERISTICS

T_A = 25°C, V_{DD} = PV_{DD} = 5 V (unless otherwise noted)

PARAMETER	TEST CONDITIONS	MIN	TYP	MAX	UNIT
V _{OO}	Output offset voltage (measured differentially) V _I = 0 V			25	mV
PSRR	Power supply rejection ratio V _{DD} =PV _{DD} = 4.5 V to 5.5 V		-77		dB
I _{IH}	High-level input current V _{DD} =PV _{DD} = 5.5 V, V _I = V _{DD} = PV _{DD}			1	μA
I _{IL}	Low-level input current V _{DD} =PV _{DD} = 5.5 V, V _I = 0 V			1	μA
I _{DD}	Supply current No filter (with or without speaker load)		8	10	mA
I _{DD}	Supply current With filter, L = 22 μH, C = 1 μF		15		mA
I _{DD(SD)}	Supply current, shutdown mode		1	15	μA

OPERATING CHARACTERISTICS

T_A = 25°C, V_{DD} = PV_{DD} = 5 V, R_L = 4 Ω, Gain = 8 dB (unless otherwise noted)

PARAMETER	TEST CONDITIONS	MIN	TYP	MAX	UNIT
P _O	Output power THD = 0.1%, f = 1 kHz, R _L = 3 Ω		2		W
THD+N	Total harmonic distortion plus noise P _O = 1 W, f = 20 Hz to 20 kHz		<0.5%		
B _{OM}	Maximum output power bandwidth THD = 5%		20		kHz
k _{SVR}	Supply ripple rejection ratio f = 1 kHz, C _(BYPASS) = 0.4 μF		-60		dB
SNR	Signal-to-noise ratio		87		dBV
	Integrated noise floor		56		μV
Z _I	Input impedance		>20		kΩ

Table 1. Gain Settings

GAIN1	GAIN0	AMPLIFIER GAIN (dB)	INPUT IMPEDANCE (kΩ)
		TYP	TYP
0	0	8	104
0	1	12	74
1	0	17.5	44
1	1	23.5	24

TYPICAL CHARACTERISTICS

Table of Graphs

			FIGURE
η	Efficiency	vs Output power	2, 3
	FFT at 1.5 W output power	vs Frequency	4
THD+N	Total harmonic distortion plus noise	vs Output power	5-7
		vs Frequency	8, 9
	Crosstalk	vs Frequency	10
	Power supply rejection ratio	vs Frequency	11

TEST SET-UP FOR GRAPHS

The THD+N measurements shown do not use an LC output filter, but use a low pass filter with a cutoff frequency of 20 kHz so the switching frequency does not dominate the measurement. This is done to ensure that the THD+N measured is just the audible THD+N. The THD+N measurements are shown at the highest gain for worst case.

The LC output filter used in the efficiency curves (Figure 2 and Figure 3) is shown in Figure 1.

$L1 = L2 = 22 \mu\text{H}$ (DCR = 110 m Ω ,
 Part number = SCD0703T-220 M-S,
 Manufacturer = GCI)
 $C1 = C2 = 1 \mu\text{F}$

The ferrite filter used in the efficiency curves (Figure 2 and Figure 3) is shown in Figure 1, where L is a ferrite bead.

$L1 = L2 =$ ferrite bead (part number = 2512067007Y3, manufacturer = Fair-Rite)
 $C1 = C2 = 1 \text{ nF}$

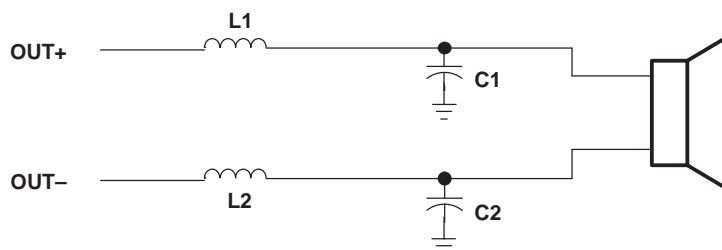

Figure 1. Class-D Output Filter

TYPICAL CHARACTERISTICS

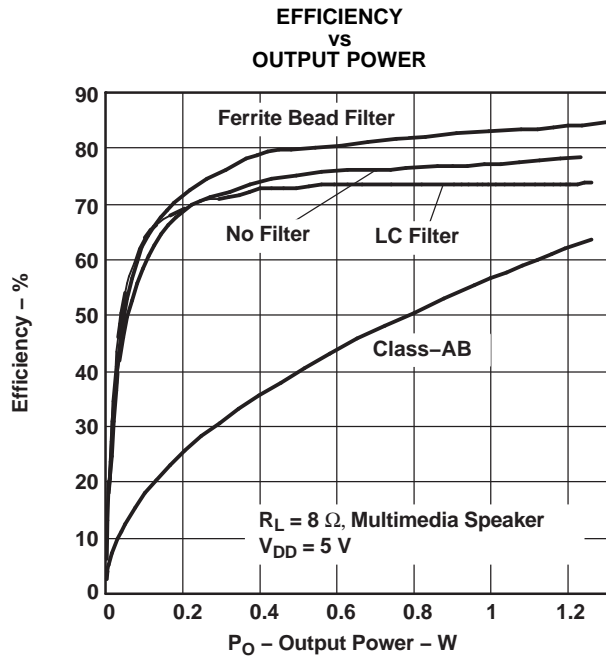

Figure 2.

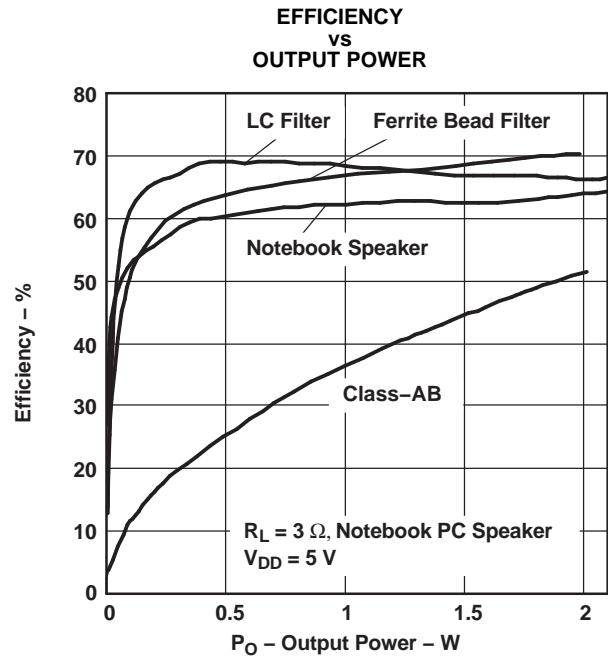

Figure 3.

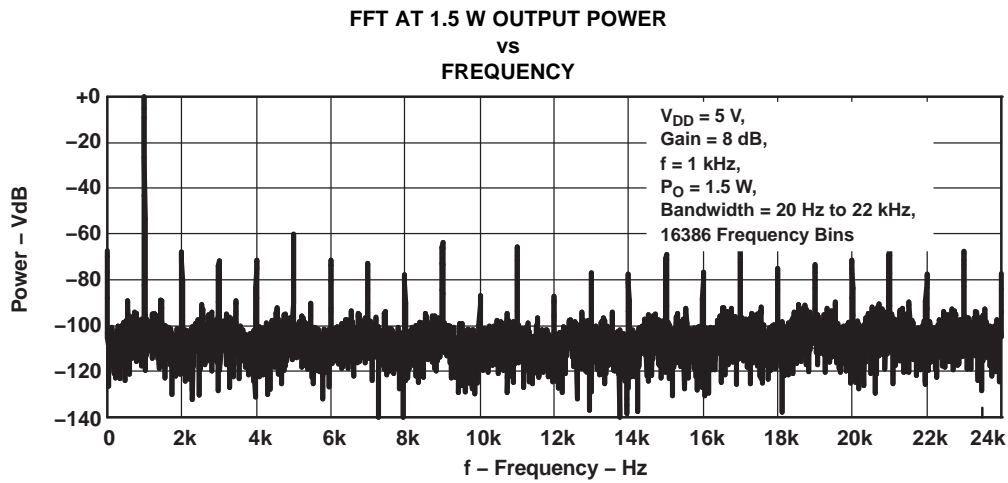

Figure 4.

TYPICAL CHARACTERISTICS (continued)

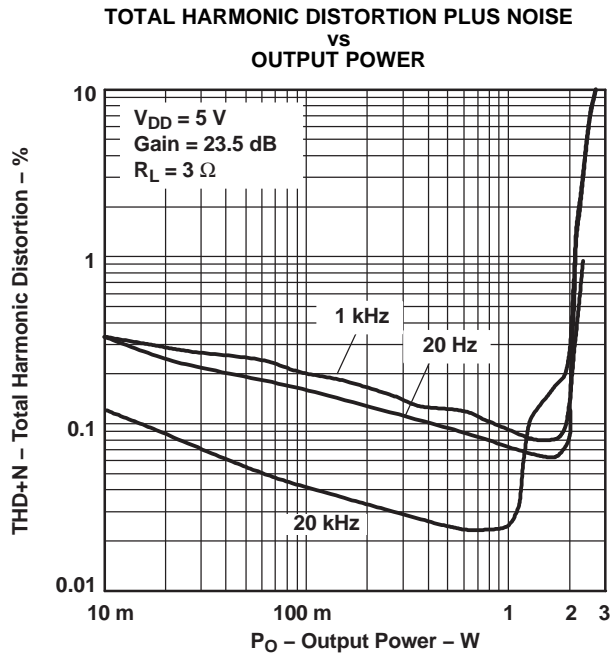

Figure 5.

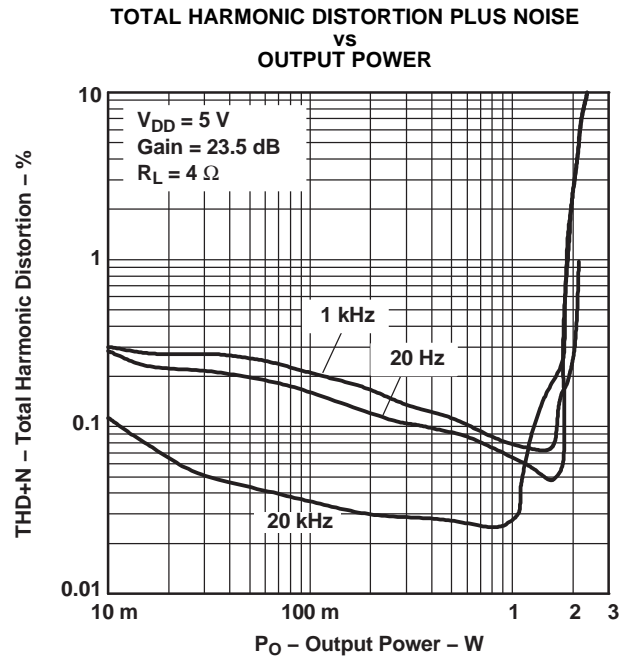

Figure 6.

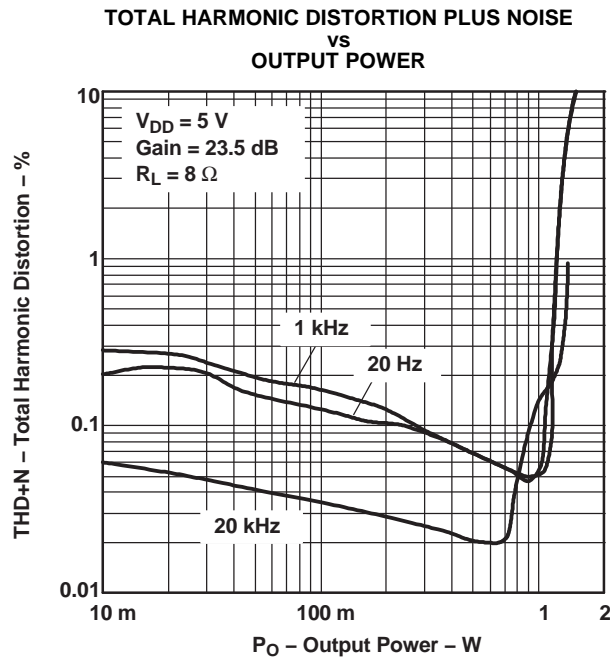

Figure 7.

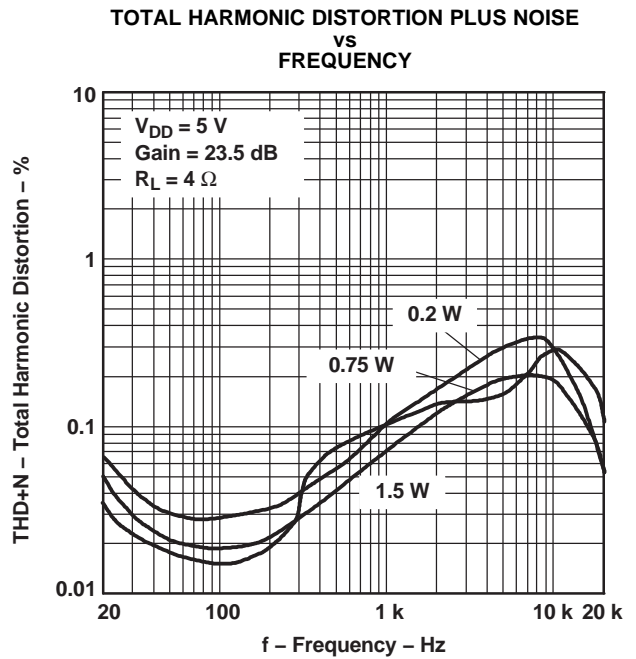

Figure 8.

TYPICAL CHARACTERISTICS (continued)

**TOTAL HARMONIC DISTORTION PLUS NOISE
vs
FREQUENCY**

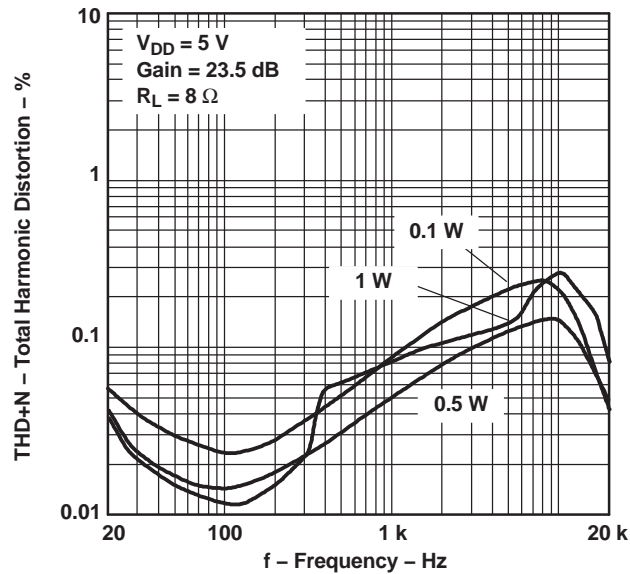

Figure 9.

**CROSSTALK
vs
FREQUENCY**

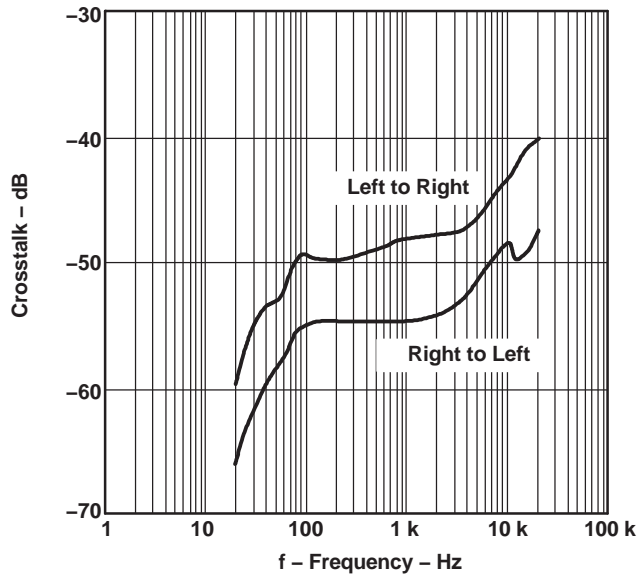

Figure 10.

**POWER SUPPLY REJECTION RATIO
vs
FREQUENCY**

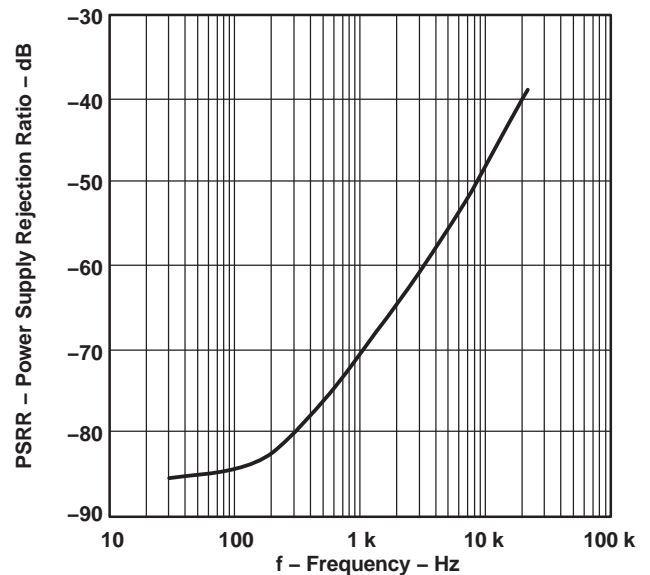

Figure 11.

APPLICATION INFORMATION

ELIMINATING THE OUTPUT FILTER WITH THE TPA2000D2

This section focuses on why the user can eliminate the output filter with the TPA2000D2.

EFFECT ON AUDIO

The class-D amplifier outputs a pulse-width modulated (PWM) square wave, which is the sum of the switching waveform and the amplified input audio signal. The human ear acts as a band-pass filter such that only the frequencies between approximately 20 Hz and 20 kHz are passed. The switching frequency components are much greater than 20 kHz, so the only signal heard is the amplified input audio signal.

TRADITIONAL CLASS-D MODULATION SCHEME

The traditional class-D modulation scheme, which is used in the TPA005Dxx family, has a differential output where each output is 180 degrees out of phase and changes from ground to the supply voltage, V_{DD} . Therefore, the differential prefiltered output varies between positive and negative V_{DD} , where filtered 50% duty cycle yields 0 volts across the load. The traditional class-D modulation scheme with voltage and current waveforms is shown in Figure 12. Note that even at an average of 0 volts across the load (50% duty cycle), the current to the load is high causing high loss, thus causing a high supply current.

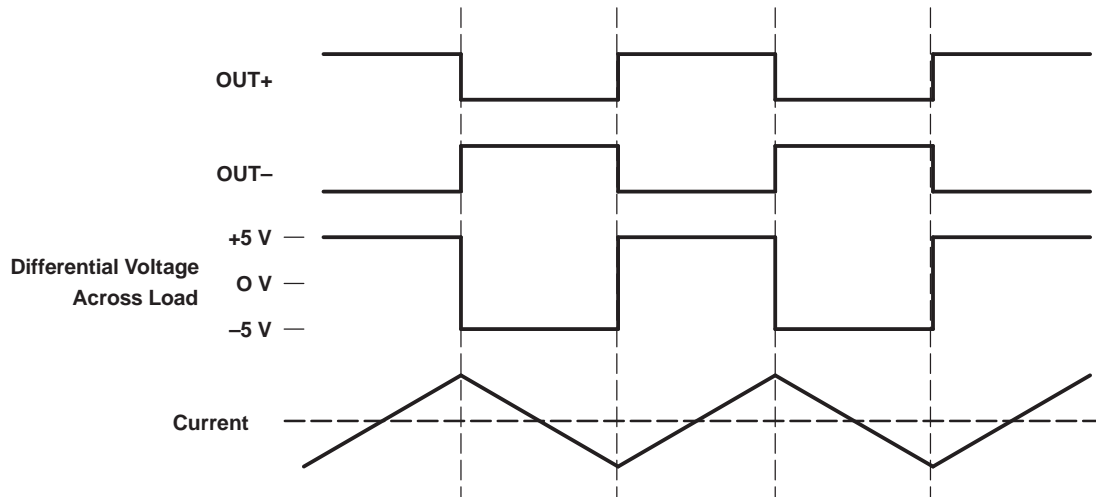

Figure 12. Traditional Class-D Modulation Scheme's Output Voltage and Current Waveforms Into an Inductive Load With No Input

TPA2000D2 MODULATION SCHEME

The TPA2000D2 uses a modulation scheme that still has each output switching from 0 to the supply voltage. However, OUT+ and OUT- are now in phase with each other with no input. The duty cycle of OUT+ is greater than 50% and OUT- is less than 50% for positive voltages. The duty cycle of OUT+ is less than 50% and OUT- is greater than 50% for negative voltages. The voltage across the load sits at 0 volts throughout most of the switching period greatly reducing the switching current, which reduces any I^2R losses in the load.

APPLICATION INFORMATION (continued)

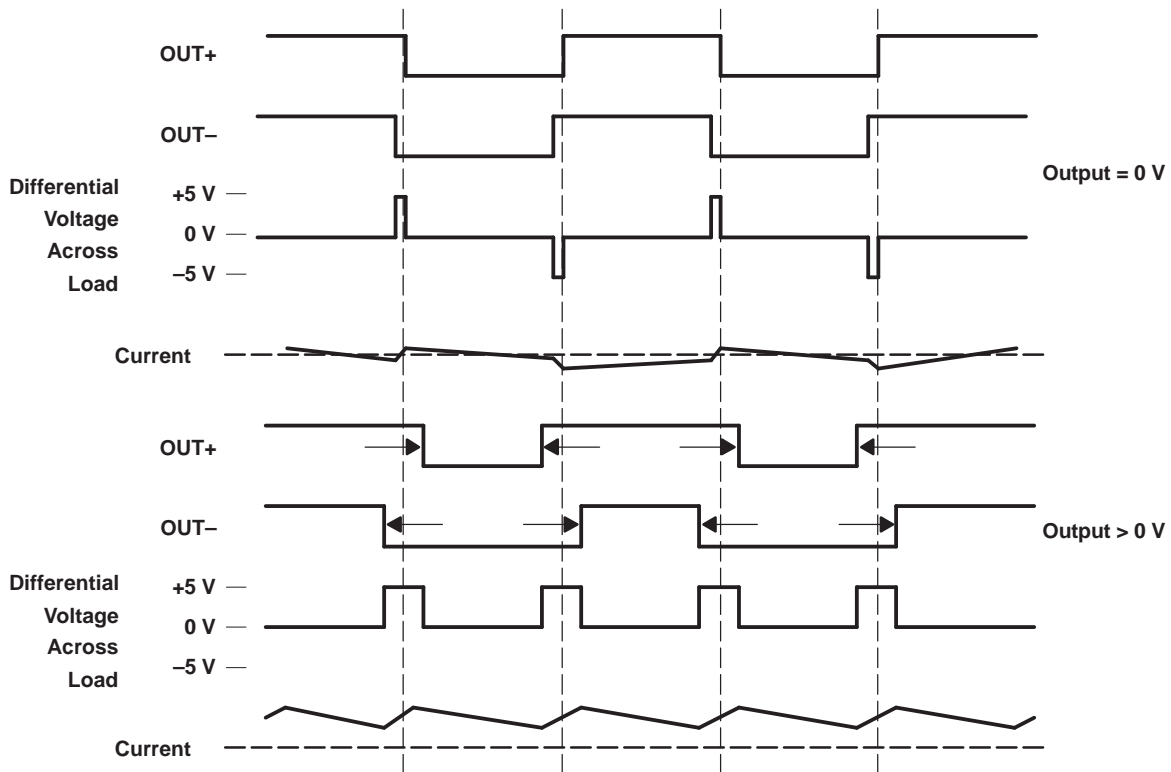

Figure 13. The TPA2000D2 Output Voltage and Current Waveforms Into an Inductive Load

EFFICIENCY: WHY YOU MUST USE A FILTER WITH THE TRADITIONAL CLASS-D MODULATION SCHEME

The main reason that the traditional class-D amplifier needs an output filter is that the switching waveform results in maximum current flow. This causes more loss in the load, which causes lower efficiency. The ripple current is large for the traditional modulation scheme because the ripple current is proportional to voltage multiplied by the time at that voltage. The differential voltage swing is $2 \times V_{DD}$ and the time at each voltage is half the period for the traditional modulation scheme. An ideal LC filter is needed to store the ripple current from each half cycle for the next half cycle, while any resistance causes power dissipation. The speaker is both resistive and reactive, whereas an LC filter is almost purely reactive.

The TPA2000D2 modulation scheme has very little loss in the load without a filter because the pulses are very short and the change in voltage is V_{DD} instead of $2 \times V_{DD}$. As the output power increases, the pulses widen making the ripple current larger. Ripple current could be filtered with an LC filter for increased efficiency, but for most applications the filter is not needed.

An LC filter with a cutoff frequency less than the class-D switching frequency allows the switching current to flow through the filter instead of the load. The filter has less resistance than the speaker, which results in less power dissipated and increased efficiency.

EFFECTS OF APPLYING A SQUARE WAVE INTO A SPEAKER

Audio specialists have said for years not to apply a square wave to speakers. If the amplitude of the waveform is high enough and the frequency of the square wave is within the bandwidth of the speaker, the square wave could cause the voice coil to jump out of the air gap and/or scar the voice coil. A 250-kHz switching frequency, however, is not significant because the speaker cone movement is proportional to $1/f^2$ for frequencies beyond the audio band. Therefore, the amount of cone movement at the switching frequency is very small. However,

APPLICATION INFORMATION (continued)

damage could occur to the speaker if the voice coil is not designed to handle the additional power. To size the speaker for added power, the ripple current dissipated in the load needs to be calculated by subtracting the theoretical supplied power, $P_{\text{SUP THEORETICAL}}$, from the actual supply power, P_{SUP} , at maximum output power, P_{OUT} . The switching power dissipated in the speaker is the inverse of the measured efficiency, η_{MEASURED} , minus the theoretical efficiency, $\eta_{\text{THEORETICAL}}$.

$$P_{\text{SPKR}} = P_{\text{SUP}} - P_{\text{SUP THEORETICAL}} \text{ (at max output power)} \quad (1)$$

$$P_{\text{SPKR}} = P_{\text{SUP}} / P_{\text{OUT}} - P_{\text{SUP THEORETICAL}} / P_{\text{OUT}} \text{ (at max output power)} \quad (2)$$

$$P_{\text{SPKR}} = 1/\eta_{\text{MEASURED}} - 1/\eta_{\text{THEORETICAL}} \text{ (at max output power)} \quad (3)$$

The maximum efficiency of the TPA2000D2 with an 8- Ω load is 85%. Using [Equation 3](#) with the efficiency at maximum power from [Figure 2](#) (78%), we see that there is an additional 106 mW dissipated in the speaker. The added power dissipated in the speaker is not an issue as long as it is taken into account when choosing the speaker.

WHEN TO USE AN OUTPUT FILTER

Design the TPA2000D2 without the filter if the traces from amplifier to speaker are short. The TPA2000D2 passed FCC and CE radiated emissions with no shielding with speaker wires 8 inches (20,32 cm) long or less. Notebook PCs and powered speakers where the speaker is in the same enclosure as the amplifier are good applications for class-D without a filter.

A ferrite bead filter can often be used if the design is failing radiated emissions without a filter, and the frequency sensitive circuit is greater than 1 MHz. This is good for circuits that just have to pass FCC and CE because FCC and CE only test radiated emissions greater than 30 MHz. If choosing a ferrite bead, choose one with high impedance at high frequencies, but very low impedance at low frequencies.

Use an output filter if there are low frequency (< 1 MHz) EMI sensitive circuits and/or there are long leads from amplifier to speaker.

GAIN SETTING VIA GAIN0 AND GAIN1 INPUTS

The gain of the TPA2000D2 is set by two input terminals, GAIN0 and GAIN1.

The gains listed in [Table 2](#) are realized by changing the taps on the input resistors inside the amplifier. This causes the input impedance, Z_i , to be dependent on the gain setting. The actual gain settings are controlled by ratios of resistors, so the actual gain distribution from part-to-part is quite good. However, the input impedance may shift by 30% due to shifts in the actual resistance of the input resistors.

For design purposes, the input network (discussed in the next section) should be designed assuming an input impedance of 20 k Ω , which is the absolute minimum input impedance of the TPA2000D2. At the lower gain settings, the input impedance could increase to as high as 115 k Ω .

Table 2. Gain Settings

GAIN1	GAIN0	AMPLIFIER GAIN (dB)	INPUT IMPEDANCE (k Ω)
		TYP	TYP
0	0	8	104
0	1	12	74
1	0	17.5	44
1	1	23.5	24

INPUT RESISTANCE

Each gain setting is achieved by varying the input resistance of the amplifier, which can range from its smallest value to over 6 times that value.

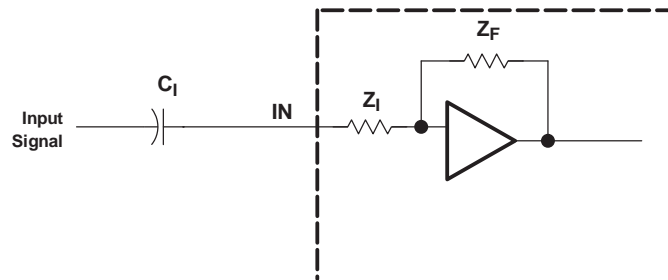

The -3 dB frequency can be calculated using [Equation 4](#):

$$f_{-3\text{ dB}} = \frac{1}{2\pi C_1 Z_1} \quad (4)$$

INPUT CAPACITOR, C_1

In the typical application an input capacitor, C_1 , is required to allow the amplifier to bias the input signal to the proper dc level for optimum operation. In this case, C_1 and the input impedance of the amplifier, Z_1 , form a high-pass filter with the corner frequency determined in [Equation 5](#).

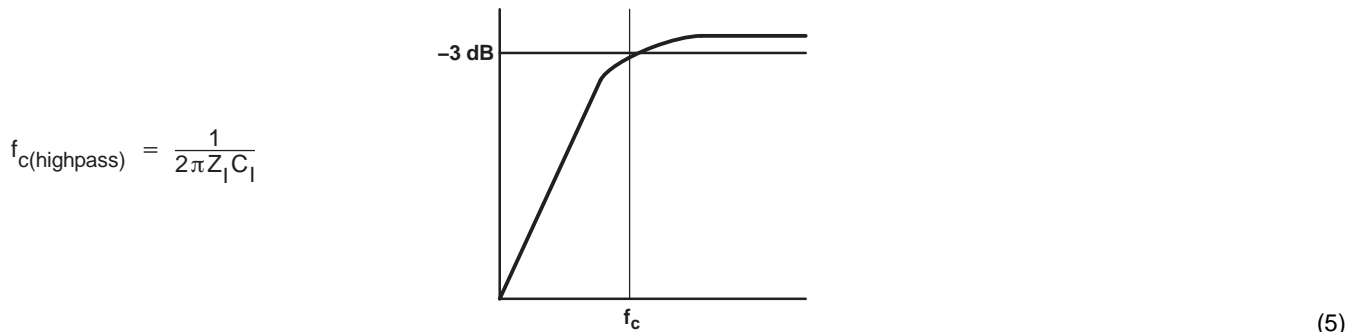

The value of C_1 is important, as it directly affects the bass (low frequency) performance of the circuit. Consider the example where Z_1 is 20 k Ω and the specification calls for a flat bass response down to 80 Hz. [Equation 5](#) is reconfigured as [Equation 6](#).

$$C_1 = \frac{1}{2\pi Z_1 f_c} \quad (6)$$

In this example, C_1 is 0.1 μF , so one would likely choose a value in the range of 0.1 μF to 1 μF . If the gain is known and is constant, use Z_1 from [Table 1](#) to calculate C_1 . A further consideration for this capacitor is the leakage path from the input source through the input network (C_1) and the feedback network to the load. This leakage current creates a dc offset voltage at the input to the amplifier that reduces useful headroom, especially in high gain applications. For this reason a low-leakage tantalum or ceramic capacitor is the best choice. When polarized capacitors are used, the positive side of the capacitor should face the amplifier input in most applications as the dc level there is held at $V_{DD}/2$, which is likely higher than the source dc level. Note that it is important to confirm the capacitor polarity in the application.

C_1 should be 10 times smaller than the bypass capacitor to reduce clicking and popping noise from power on/off and entering and leaving shutdown. After sizing C_1 for a given cutoff frequency, size the bypass capacitor up to 10 times that of the input capacitor.

$$C_1 \leq C_{BYP} / 10 \quad (7)$$

SWITCHING FREQUENCY

The switching frequency is determined using the values of the components connected to R_{OSC} (pin 18) and C_{OSC} (pin 7) and is calculated with the following equation:

$$f_s = \frac{6.6}{R_{OSC} C_{OSC}} \quad (8)$$

The switching frequency was chosen to be centered on 250 kHz. This frequency is the optimum audio fidelity of oversampling and of maximizing efficiency by minimizing the switching losses of the amplifier. The recommended values are a resistance of 120 k Ω and a capacitance of 220 pF. Using these component values, the amplifier operates properly by using 5% tolerance resistors and 10% tolerance capacitors. The tolerance of the components can be changed, as long as the switching frequency remains between 200 kHz and 300 kHz. Within this range, the internal circuitry of the device provides stable operation.

POWER SUPPLY DECOUPLING, C_S

The TPA2000D2 is a high-performance CMOS audio amplifier that requires adequate power supply decoupling to ensure the output total harmonic distortion (THD) is as low as possible. Power supply decoupling also prevents oscillations for long lead lengths between the amplifier and the speaker. The optimum decoupling is achieved by using two capacitors of different types that target different types of noise on the power supply leads. For higher frequency transients, spikes, or digital hash on the line, a good low equivalent-series-resistance (ESR) ceramic capacitor, typically 0.1 μ F placed as close as possible to the device V_{DD} lead works best. For filtering lower-frequency noise signals, a larger aluminum electrolytic capacitor of 10 μ F or greater placed near the audio power amplifier is recommended.

MIDRAIL BYPASS CAPACITOR, C_{BYP}

The midrail bypass capacitor, C_{BYP} , is the most critical capacitor and serves several important functions. During start-up or recovery from shutdown mode, C_{BYP} determines the rate at which the amplifier starts up. The second function is to reduce noise produced by the power supply caused by coupling into the output drive signal. This noise is from the midrail generation circuit internal to the amplifier, which appears as degraded PSRR and THD+N.

Bypass capacitor, C_{BYP} , values of 0.47 μ F to 1 μ F ceramic or tantalum low-ESR capacitors are recommended for the best THD and noise performance.

Increasing the bypass capacitor reduces clicking and popping noise from power on/off and entering and leaving shutdown. To have minimal pop, C_{BYP} should be 10 times larger than C_I .

$$C_{BYP} \geq 10 \times C_I \quad (9)$$

DIFFERENTIAL INPUT

The differential input stage of the amplifier cancels any noise that appears on both input lines of a channel. To use the TPA2000D2 EVM with a differential source, connect the positive lead of the audio source to the RINP (LINP) input and the negative lead from the audio source to the RINN (LINN) input. To use the TPA2000D2 with a single-ended source, ac ground the RINN and LINN inputs through a capacitor and apply the audio single to the RINP and LINP inputs. In a single-ended input application, the RINN and LINN inputs should be ac-grounded at the audio source instead of at the device inputs for best noise performance.

SHUTDOWN MODES

The TPA2000D2 employs a shutdown mode of operation designed to reduce supply current, I_{DD} , to the absolute minimum level during periods of nonuse for battery-power conservation. The **SHUTDOWN** input terminal should be held high during normal operation when the amplifier is in use. Pulling **SHUTDOWN** low causes the outputs to mute and the amplifier to enter a low-current state, $I_{DD(SD)} = 1 \mu$ A. **SHUTDOWN** should never be left unconnected, because amplifier operation would be unpredictable.

USING LOW-ESR CAPACITORS

Low-ESR capacitors are recommended throughout this application section. A real (as opposed to ideal) capacitor can be modeled simply as a resistor in series with an ideal capacitor. The voltage drop across this resistor minimizes the beneficial effects of the capacitor in the circuit. The lower the equivalent value of this resistance the more the real capacitor behaves like an ideal capacitor.

EVALUATION CIRCUIT

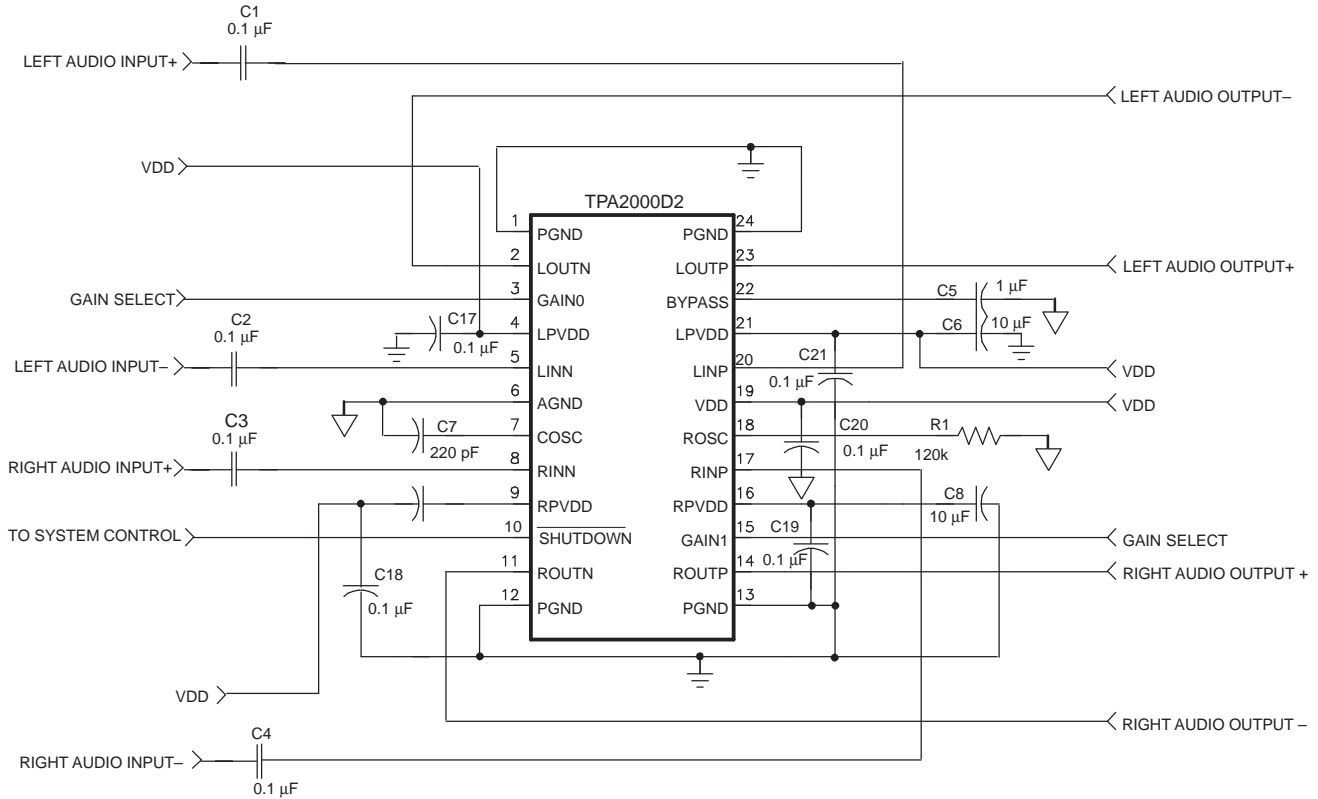

Table 3. TPA2000D2 Application Bill of Materials

REFERENCE	DESCRIPTION	SIZE	QUANTITY	MANUFACTURER	PART NUMBER
C1-4, C17-21	Capacitor, ceramic chip, 0.1 µF, ±10%, X7R, 50 V	0805	9	Kemet	C0805C104K5RAC
C5	Capacitor, ceramic, 1.0 µF, 80%/-20%, Y5V, 16 V	0805	1	Murata	GRM40-Y5V105Z16
C6, C8	Capacitor, ceramic, 10 µF, 80%/-20%, Y5V, 16 V	1210	2	Murata	GRM235-Y5V106Z16
C7	Capacitor, ceramic, 220 pF, ±10%, XICON, 50 V	0805	2	Mouser	140-CC501B221K
R1	Resistor, chip, 120 kΩ, 1/10 W, 5%, XICON	0805	1	Mouser	260-120K
U1	IC, TPA2000D2, audio power amplifier, 2-W, 2-channel, class-D	24 pin TSSOP	1	TI	TPA2000D2PWP

PACKAGING INFORMATION

Orderable Device	Status (1)	Package Type	Package Drawing	Pins	Package Qty	Eco Plan (2)	Lead/Ball Finish (6)	MSL Peak Temp (3)	Op Temp (°C)	Device Marking (4/5)	Samples
TPA2000D2PW	ACTIVE	TSSOP	PW	24	60	Green (RoHS & no Sb/Br)	CU NIPDAU	Level-2-260C-1 YEAR	-40 to 85	TPA2000D2	Samples
TPA2000D2PWG4	ACTIVE	TSSOP	PW	24	60	Green (RoHS & no Sb/Br)	CU NIPDAU	Level-2-260C-1 YEAR	-40 to 85	TPA2000D2	Samples
TPA2000D2PWP	ACTIVE	HTSSOP	PWP	24	60	Green (RoHS & no Sb/Br)	CU NIPDAU	Level-2-260C-1 YEAR	-40 to 85	TPA2000D2	Samples
TPA2000D2PWPG4	ACTIVE	HTSSOP	PWP	24	60	Green (RoHS & no Sb/Br)	CU NIPDAU	Level-2-260C-1 YEAR	-40 to 85	TPA2000D2	Samples
TPA2000D2PWPR	ACTIVE	HTSSOP	PWP	24	2000	Green (RoHS & no Sb/Br)	CU NIPDAU	Level-2-260C-1 YEAR	-40 to 85	TPA2000D2	Samples
TPA2000D2PWR	ACTIVE	TSSOP	PW	24	2000	Green (RoHS & no Sb/Br)	CU NIPDAU	Level-2-260C-1 YEAR	-40 to 85	TPA2000D2	Samples
TPA2000D2PWRG4	ACTIVE	TSSOP	PW	24	2000	Green (RoHS & no Sb/Br)	CU NIPDAU	Level-2-260C-1 YEAR	-40 to 85	TPA2000D2	Samples

(1) The marketing status values are defined as follows:

ACTIVE: Product device recommended for new designs.

LIFEBUY: TI has announced that the device will be discontinued, and a lifetime-buy period is in effect.

NRND: Not recommended for new designs. Device is in production to support existing customers, but TI does not recommend using this part in a new design.

PREVIEW: Device has been announced but is not in production. Samples may or may not be available.

OBSELETE: TI has discontinued the production of the device.

(2) Eco Plan - The planned eco-friendly classification: Pb-Free (RoHS), Pb-Free (RoHS Exempt), or Green (RoHS & no Sb/Br) - please check <http://www.ti.com/productcontent> for the latest availability information and additional product content details.

TBD: The Pb-Free/Green conversion plan has not been defined.

Pb-Free (RoHS): TI's terms "Lead-Free" or "Pb-Free" mean semiconductor products that are compatible with the current RoHS requirements for all 6 substances, including the requirement that lead not exceed 0.1% by weight in homogeneous materials. Where designed to be soldered at high temperatures, TI Pb-Free products are suitable for use in specified lead-free processes.

Pb-Free (RoHS Exempt): This component has a RoHS exemption for either 1) lead-based flip-chip solder bumps used between the die and package, or 2) lead-based die adhesive used between the die and leadframe. The component is otherwise considered Pb-Free (RoHS compatible) as defined above.

Green (RoHS & no Sb/Br): TI defines "Green" to mean Pb-Free (RoHS compatible), and free of Bromine (Br) and Antimony (Sb) based flame retardants (Br or Sb do not exceed 0.1% by weight in homogeneous material)

(3) MSL, Peak Temp. - The Moisture Sensitivity Level rating according to the JEDEC industry standard classifications, and peak solder temperature.

(4) There may be additional marking, which relates to the logo, the lot trace code information, or the environmental category on the device.

⁽⁵⁾ Multiple Device Markings will be inside parentheses. Only one Device Marking contained in parentheses and separated by a "-" will appear on a device. If a line is indented then it is a continuation of the previous line and the two combined represent the entire Device Marking for that device.

⁽⁶⁾ Lead/Ball Finish - Orderable Devices may have multiple material finish options. Finish options are separated by a vertical ruled line. Lead/Ball Finish values may wrap to two lines if the finish value exceeds the maximum column width.

Important Information and Disclaimer:The information provided on this page represents TI's knowledge and belief as of the date that it is provided. TI bases its knowledge and belief on information provided by third parties, and makes no representation or warranty as to the accuracy of such information. Efforts are underway to better integrate information from third parties. TI has taken and continues to take reasonable steps to provide representative and accurate information but may not have conducted destructive testing or chemical analysis on incoming materials and chemicals. TI and TI suppliers consider certain information to be proprietary, and thus CAS numbers and other limited information may not be available for release.

In no event shall TI's liability arising out of such information exceed the total purchase price of the TI part(s) at issue in this document sold by TI to Customer on an annual basis.

TAPE AND REEL INFORMATION
REEL DIMENSIONS

TAPE DIMENSIONS

A0	Dimension designed to accommodate the component width
B0	Dimension designed to accommodate the component length
K0	Dimension designed to accommodate the component thickness
W	Overall width of the carrier tape
P1	Pitch between successive cavity centers

TAPE AND REEL INFORMATION

*All dimensions are nominal

Device	Package Type	Package Drawing	Pins	SPQ	Reel Diameter (mm)	Reel Width W1 (mm)	A0 (mm)	B0 (mm)	K0 (mm)	P1 (mm)	W (mm)	Pin1 Quadrant
TPA2000D2PWPR	HTSSOP	PWP	24	2000	330.0	16.4	6.95	8.3	1.6	8.0	16.0	Q1
TPA2000D2PWR	TSSOP	PW	24	2000	330.0	16.4	6.95	8.3	1.6	8.0	16.0	Q1

TAPE AND REEL BOX DIMENSIONS



*All dimensions are nominal

Device	Package Type	Package Drawing	Pins	SPQ	Length (mm)	Width (mm)	Height (mm)
TPA2000D2PWPR	HTSSOP	PWP	24	2000	367.0	367.0	38.0
TPA2000D2PWR	TSSOP	PW	24	2000	367.0	367.0	38.0

PW (R-PDSO-G24)

PLASTIC SMALL OUTLINE



- NOTES:
- A. All linear dimensions are in millimeters. Dimensioning and tolerancing per ASME Y14.5M-1994.
 - B. This drawing is subject to change without notice.
 -  Body length does not include mold flash, protrusions, or gate burrs. Mold flash, protrusions, or gate burrs shall not exceed 0,15 each side.
 -  Body width does not include interlead flash. Interlead flash shall not exceed 0,25 each side.
 - E. Falls within JEDEC MO-153

PW (R-PDSO-G24)

PLASTIC SMALL OUTLINE

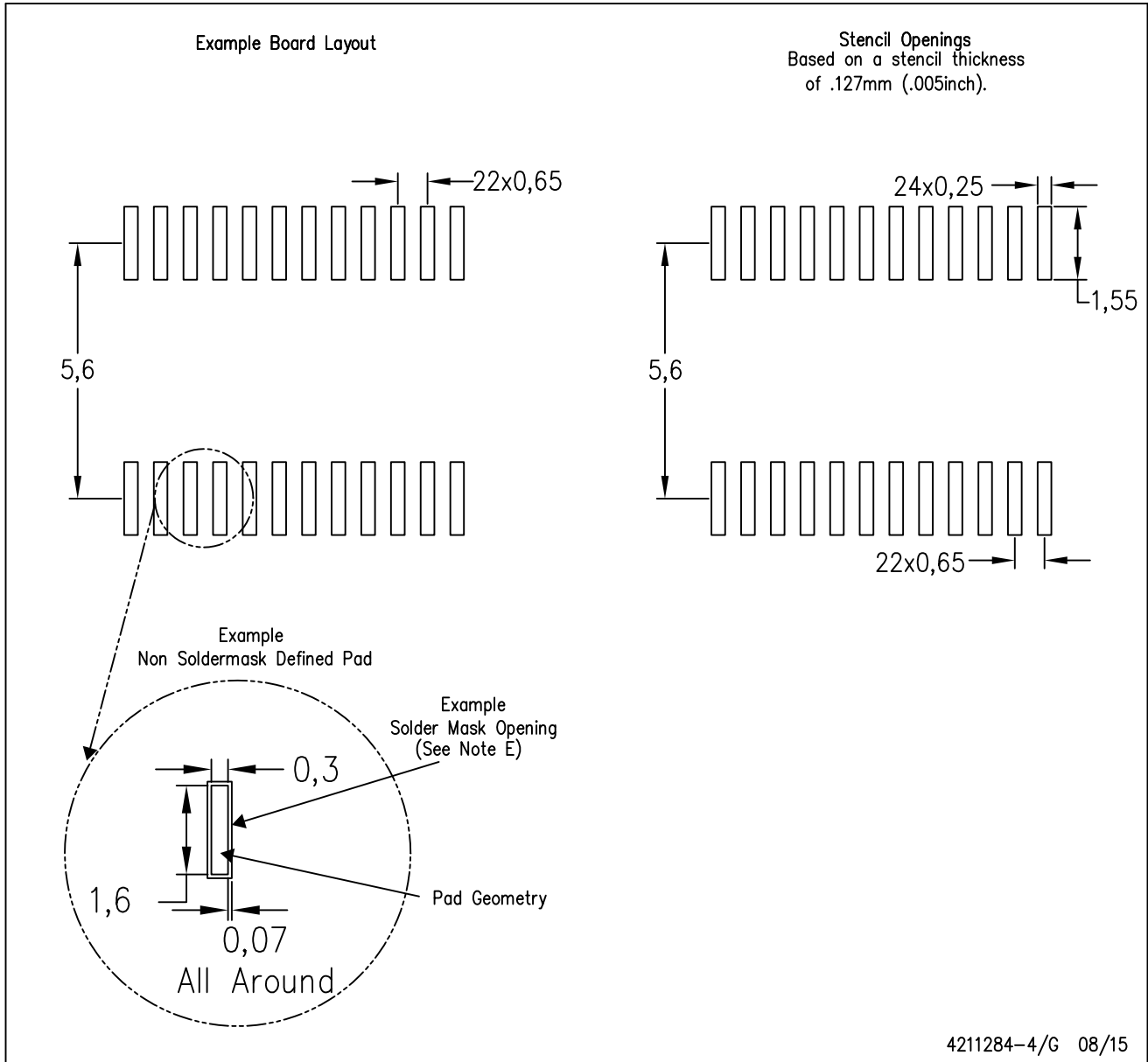

4211284-4/G 08/15

- NOTES:
- A. All linear dimensions are in millimeters.
 - B. This drawing is subject to change without notice.
 - C. Publication IPC-7351 is recommended for alternate design.
 - D. Laser cutting apertures with trapezoidal walls and also rounding corners will offer better paste release. Customers should contact their board assembly site for stencil design recommendations. Refer to IPC-7525 for other stencil recommendations.
 - E. Customers should contact their board fabrication site for solder mask tolerances between and around signal pads.

MECHANICAL DATA

PWP (R-PDSO-G24)

PowerPAD™ PLASTIC SMALL OUTLINE



- NOTES:
- All linear dimensions are in millimeters.
 - This drawing is subject to change without notice.
 - Body dimensions do not include mold flash or protrusions. Mold flash and protrusion shall not exceed 0.15 per side.
 - This package is designed to be soldered to a thermal pad on the board. Refer to Technical Brief, PowerPad Thermally Enhanced Package, Texas Instruments Literature No. SLMA002 for information regarding recommended board layout. This document is available at www.ti.com <<http://www.ti.com>>.
 - See the additional figure in the Product Data Sheet for details regarding the exposed thermal pad features and dimensions.
 - Falls within JEDEC MO-153

PowerPAD is a trademark of Texas Instruments.

THERMAL PAD MECHANICAL DATA

PWP (R-PDSO-G24) PowerPAD™ SMALL PLASTIC OUTLINE

THERMAL INFORMATION

This PowerPAD™ package incorporates an exposed thermal pad that is designed to be attached to a printed circuit board (PCB). The thermal pad must be soldered directly to the PCB. After soldering, the PCB can be used as a heatsink. In addition, through the use of thermal vias, the thermal pad can be attached directly to the appropriate copper plane shown in the electrical schematic for the device, or alternatively, can be attached to a special heatsink structure designed into the PCB. This design optimizes the heat transfer from the integrated circuit (IC).

For additional information on the PowerPAD package and how to take advantage of its heat dissipating abilities, refer to Technical Brief, PowerPAD Thermally Enhanced Package, Texas Instruments Literature No. SLMA002 and Application Brief, PowerPAD Made Easy, Texas Instruments Literature No. SLMA004. Both documents are available at www.ti.com.

The exposed thermal pad dimensions for this package are shown in the following illustration.

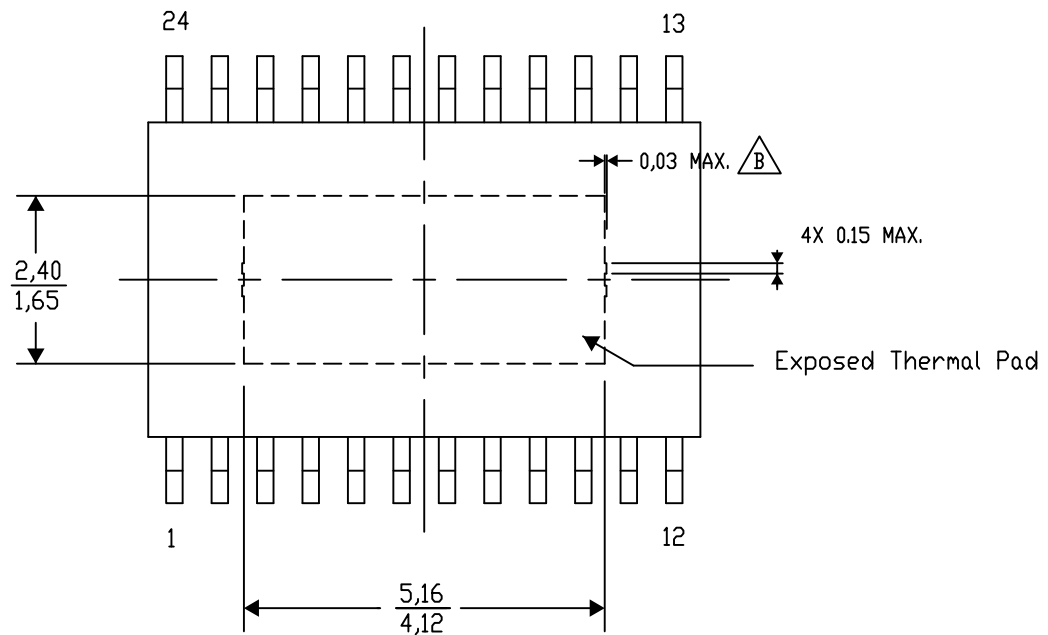

Top View

Exposed Thermal Pad Dimensions

4206332-29/AO 01/16

NOTE: A. All linear dimensions are in millimeters
B. Exposed tie strap features may not be present.

PowerPAD is a trademark of Texas Instruments

PWP (R-PDSO-G24)

PowerPAD™ PLASTIC SMALL OUTLINE

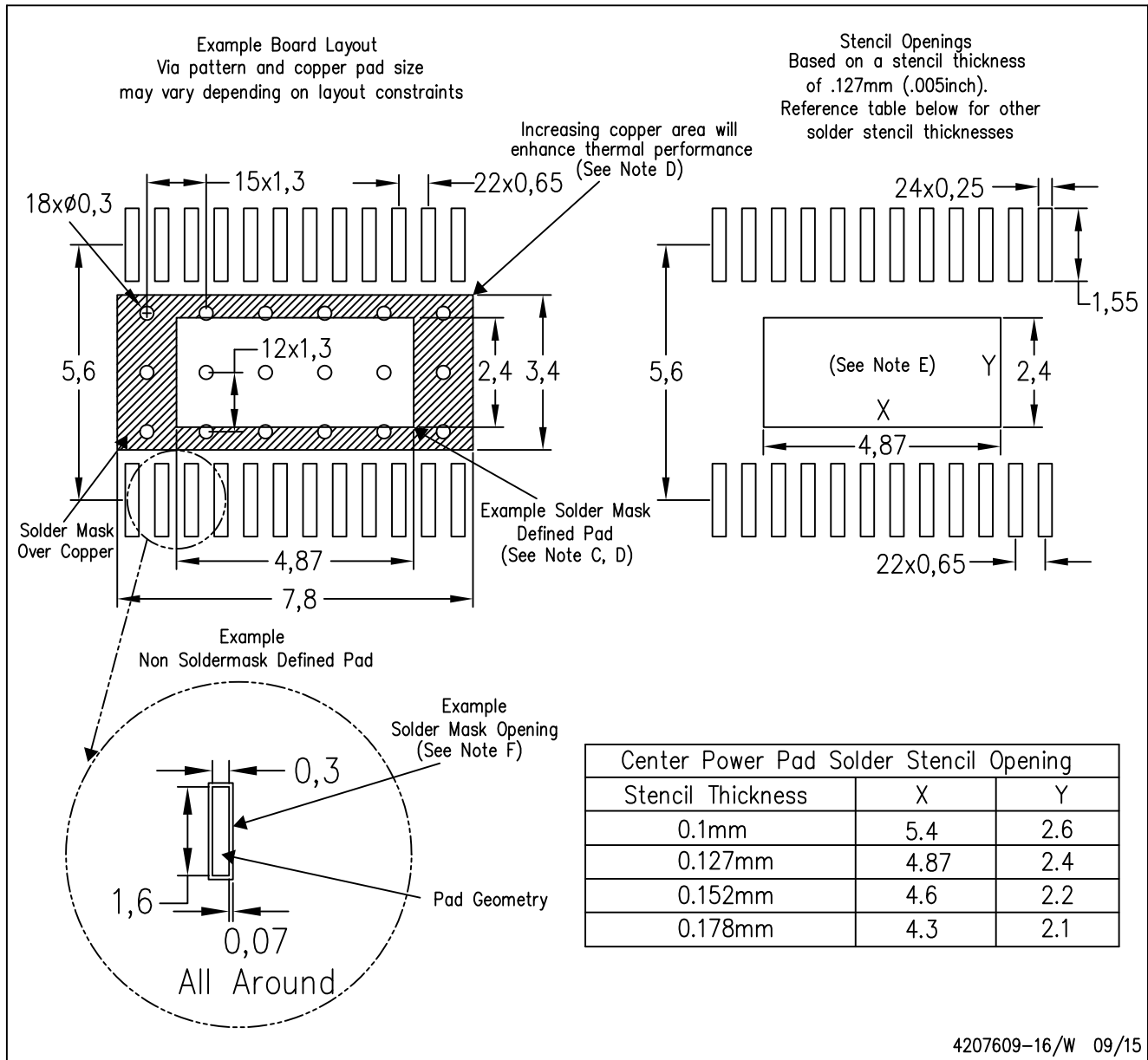

- NOTES:
- All linear dimensions are in millimeters.
 - This drawing is subject to change without notice.
 - Customers should place a note on the circuit board fabrication drawing not to alter the center solder mask defined pad.
 - This package is designed to be soldered to a thermal pad on the board. Refer to Technical Brief, PowerPAD Thermally Enhanced Package, Texas Instruments Literature No. SLMA002, SLMA004, and also the Product Data Sheets for specific thermal information, via requirements, and recommended board layout. These documents are available at www.ti.com <<http://www.ti.com>>. Publication IPC-7351 is recommended for alternate designs.
 - Laser cutting apertures with trapezoidal walls and also rounding corners will offer better paste release. Customers should contact their board assembly site for stencil design recommendations. Example stencil design based on a 50% volumetric metal load solder paste. Refer to IPC-7525 for other stencil recommendations.
 - Customers should contact their board fabrication site for solder mask tolerances between and around signal pads.

IMPORTANT NOTICE

Texas Instruments Incorporated and its subsidiaries (TI) reserve the right to make corrections, enhancements, improvements and other changes to its semiconductor products and services per JESD46, latest issue, and to discontinue any product or service per JESD48, latest issue. Buyers should obtain the latest relevant information before placing orders and should verify that such information is current and complete. All semiconductor products (also referred to herein as "components") are sold subject to TI's terms and conditions of sale supplied at the time of order acknowledgment.

TI warrants performance of its components to the specifications applicable at the time of sale, in accordance with the warranty in TI's terms and conditions of sale of semiconductor products. Testing and other quality control techniques are used to the extent TI deems necessary to support this warranty. Except where mandated by applicable law, testing of all parameters of each component is not necessarily performed.

TI assumes no liability for applications assistance or the design of Buyers' products. Buyers are responsible for their products and applications using TI components. To minimize the risks associated with Buyers' products and applications, Buyers should provide adequate design and operating safeguards.

TI does not warrant or represent that any license, either express or implied, is granted under any patent right, copyright, mask work right, or other intellectual property right relating to any combination, machine, or process in which TI components or services are used. Information published by TI regarding third-party products or services does not constitute a license to use such products or services or a warranty or endorsement thereof. Use of such information may require a license from a third party under the patents or other intellectual property of the third party, or a license from TI under the patents or other intellectual property of TI.

Reproduction of significant portions of TI information in TI data books or data sheets is permissible only if reproduction is without alteration and is accompanied by all associated warranties, conditions, limitations, and notices. TI is not responsible or liable for such altered documentation. Information of third parties may be subject to additional restrictions.

Resale of TI components or services with statements different from or beyond the parameters stated by TI for that component or service voids all express and any implied warranties for the associated TI component or service and is an unfair and deceptive business practice. TI is not responsible or liable for any such statements.

Buyer acknowledges and agrees that it is solely responsible for compliance with all legal, regulatory and safety-related requirements concerning its products, and any use of TI components in its applications, notwithstanding any applications-related information or support that may be provided by TI. Buyer represents and agrees that it has all the necessary expertise to create and implement safeguards which anticipate dangerous consequences of failures, monitor failures and their consequences, lessen the likelihood of failures that might cause harm and take appropriate remedial actions. Buyer will fully indemnify TI and its representatives against any damages arising out of the use of any TI components in safety-critical applications.

In some cases, TI components may be promoted specifically to facilitate safety-related applications. With such components, TI's goal is to help enable customers to design and create their own end-product solutions that meet applicable functional safety standards and requirements. Nonetheless, such components are subject to these terms.

No TI components are authorized for use in FDA Class III (or similar life-critical medical equipment) unless authorized officers of the parties have executed a special agreement specifically governing such use.

Only those TI components which TI has specifically designated as military grade or "enhanced plastic" are designed and intended for use in military/aerospace applications or environments. Buyer acknowledges and agrees that any military or aerospace use of TI components which have **not** been so designated is solely at the Buyer's risk, and that Buyer is solely responsible for compliance with all legal and regulatory requirements in connection with such use.

TI has specifically designated certain components as meeting ISO/TS16949 requirements, mainly for automotive use. In any case of use of non-designated products, TI will not be responsible for any failure to meet ISO/TS16949.

Products

Audio	www.ti.com/audio
Amplifiers	amplifier.ti.com
Data Converters	dataconverter.ti.com
DLP® Products	www.dlp.com
DSP	dsp.ti.com
Clocks and Timers	www.ti.com/clocks
Interface	interface.ti.com
Logic	logic.ti.com
Power Mgmt	power.ti.com
Microcontrollers	microcontroller.ti.com
RFID	www.ti-rfid.com
OMAP Applications Processors	www.ti.com/omap
Wireless Connectivity	www.ti.com/wirelessconnectivity

Applications

Automotive and Transportation	www.ti.com/automotive
Communications and Telecom	www.ti.com/communications
Computers and Peripherals	www.ti.com/computers
Consumer Electronics	www.ti.com/consumer-apps
Energy and Lighting	www.ti.com/energy
Industrial	www.ti.com/industrial
Medical	www.ti.com/medical
Security	www.ti.com/security
Space, Avionics and Defense	www.ti.com/space-avionics-defense
Video and Imaging	www.ti.com/video

TI E2E Community

e2e.ti.com