

TPA2025D1 2-W Constant Output Power Class-D Audio Amplifier With Class-G Boost Converter and Battery Tracking AGC

1 Features

- Built-In Enhanced Battery Tracking Automatic Gain Control (AGC)
 - Limits Battery Current Consumption
- 1.9 W into 8- Ω Load from 3.6-V Supply (1% THD+N)
- Integrated Adaptive Boost Converter
 - Increases Efficiency at Low Output Power
- Low Quiescent Current of 2 mA From 3.6 V
- Thermal and Short-Circuit Protection With Auto Recovery
- 20-dB Fixed Gain
- Similar Performance to TPA2015D1
- Available in 1.53-mm \times 1.982-mm, 0.5-mm Pitch 12-Ball WCSP Package

2 Applications

- Cell Phones
- PDA, GPS
- Portable Electronics and Speakers

3 Description

The TPA2025D1 is a high efficiency Class-D audio power amplifier with battery tracking AGC technology and an integrated Class-G boost converter that enhances efficiency at low output power. It drives up to 1.9 W into an 8- Ω speaker (1% THD+N). With 85% typical efficiency, the TPA2025D1 helps extend battery life when playing audio.

The built-in boost converter generates a 5.75-V supply voltage for the Class-D amplifier. This provides a louder audio output than a stand-alone amplifier directly connected to the battery. The battery tracking AGC adjusts the Class-D gain to limit battery current at lower battery voltage.

The TPA2025D1 has an integrated low-pass filter to improve the RF rejection and reduce DAC out-of-band noise, increasing the signal-to-noise ratio (SNR).

The TPA2025D1 is available in a space saving 1.53 mm \times 1.982 mm, 0.5 mm pitch DSBGA package (YZG).

Device Information⁽¹⁾

PART NUMBER	PACKAGE	BODY SIZE (NOM)
TPA2025D1	DSBGA (12)	1.53 mm \times 1.982 mm

(1) For all available packages, see the orderable addendum at the end of the datasheet.

4 Simplified Application Diagram

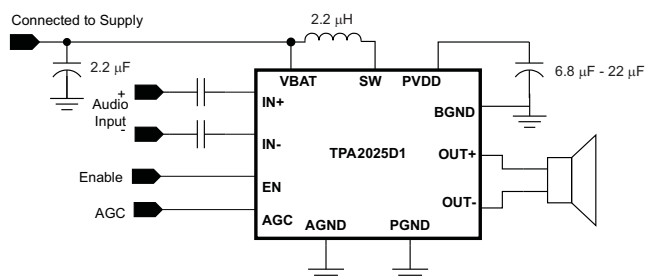

Battery Tracking Auto Gain Control

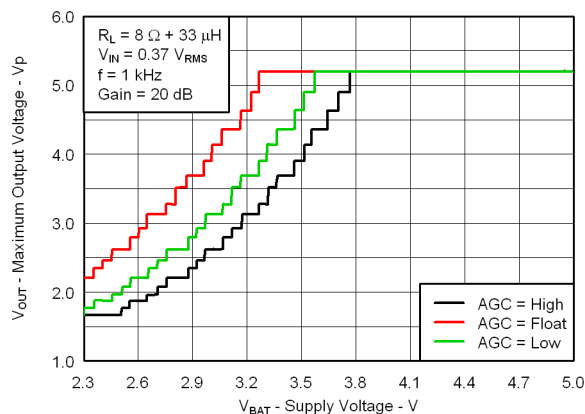

Table of Contents

1 Features	1	10.1 Overview	11
2 Applications	1	10.2 Functional Block Diagram	11
3 Description	1	10.3 Feature Description	12
4 Simplified Application Diagram	1	10.4 Device Functional Modes	13
5 Revision History	2	11 Application and Implementation	15
6 Device Comparison Table	3	11.1 Application Information	15
7 Pin Configuration and Functions	3	11.2 Typical Application	15
8 Specifications	4	12 Power Supply Recommendations	20
8.1 Absolute Maximum Ratings	4	12.1 Power Supply Decoupling Capacitors	20
8.2 ESD Ratings	4	13 Layout	20
8.3 Recommended Operating Conditions	4	13.1 Layout Guidelines	20
8.4 Thermal Information	4	13.2 Layout Example	22
8.5 Electrical Characteristics	5	14 Device and Documentation Support	23
8.6 Operating Characteristics	5	14.1 Trademarks	23
8.7 Typical Characteristics	7	14.2 Electrostatic Discharge Caution	23
9 Parameter Measurement Information	11	14.3 Glossary	23
10 Detailed Description	11	15 Mechanical, Packaging, and Orderable Information	23

5 Revision History

NOTE: Page numbers for previous revisions may differ from page numbers in the current version.

Changes from Revision A (February 2012) to Revision B

Page

- Added *Pin Configuration and Functions* section, *ESD Ratings* table, *Feature Description* section, *Device Functional Modes*, *Application and Implementation* section, *Power Supply Recommendations* section, *Layout* section, *Device and Documentation Support* section, and *Mechanical, Packaging, and Orderable Information* section **1**

Changes from Original (August 2011) to Revision A

Page

- Changed Operating quiescent current TYP value from "3.5" to "2.0" for VBAT = 3.6 V; and, TYP value from "4" to "2.5" for VBAT = 5.2 V **5**
- Changed Shutdown quiescent current MAX value from "3" to "1" **5**
- Changed from "110 ms" to "1.6 seconds" in the [SHORT CIRCUIT AUTO-RECOVERY](#) description. **13**
- Changed from "within 200 ms" to "1.6 seconds" in the [Speaker Load Limitation](#) description..... **18**

6 Device Comparison Table

DEVICE NAME	DESCRIPTION
TPA2025D1	2 W Constant Output Power Class-D Audio Amplifier with Class-G Boost Converter and Battery Tracking AGC

7 Pin Configuration and Functions

12-PIN
YZG PACKAGE
(TOP VIEW)

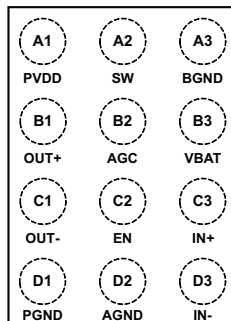

Pin Functions

NAME	PIN		INPUT/ OUTPUT/ POWER (I/O/P)	DESCRIPTION
		WCSP		
PVDD		A1	O	Boost converter output and Class-D power stage supply voltage.
SW		A2	I	Boost converter switch input; connect boost inductor between VBAT and SW.
BGND		A3	P	Boost converter power ground.
OUT+		B1	O	Positive audio output.
AGC		B2	I	AGC inflection point select. Connect to VDD, GND or Float. Voltage at AGC pin is only read at device power-up. A power cycle is required to change inflection points.
VBAT		B3	P	Supply voltage.
OUT-		C1	O	Negative audio output.
EN		C2	I	Device enable; set to logic high to enable.
IN+		C3	I	Positive audio input.
PGND		D1	P	Class-D power ground.
AGND		D2	P	Analog ground.
IN-		D3	I	Negative audio input.

8 Specifications

8.1 Absolute Maximum Ratings

Over operating free-air temperature range, $T_A = 25^\circ\text{C}$ (unless otherwise noted)⁽¹⁾

		MIN	MAX	UNIT
Supply voltage	VBAT	-0.3	6	V
Input Voltage, V_I	IN+, IN-	-0.3	VBAT + 0.3	V
Output continuous total power dissipation		See Thermal Information		
Operating free-air temperature range, T_A		-40	85	$^\circ\text{C}$
Operating junction temperature range, T_J		-40	150	$^\circ\text{C}$
Minimum load resistance		3.2		Ω
Maximum input voltage swing	EN = 0 V		2	V_{RMS}
Storage temperature range, T_{stg}		-65	150	$^\circ\text{C}$

- (1) Stresses beyond those listed under Absolute Maximum Ratings may cause permanent damage to the device. These are stress ratings only, and functional operation of the device at these or any other conditions beyond those indicated under [Recommended Operating Conditions](#) is not implied. Exposure to absolute-maximum-rated conditions for extended periods may affect device reliability.

8.2 ESD Ratings

		VALUE	UNIT
$V_{\text{(ESD)}}$ Electrostatic discharge	Human-body model (HBM), per ANSI/ESDA/JEDEC JS-001 ⁽¹⁾	± 2000	V
	Charged-device model (CDM), per JEDEC specification JESD22-C101 ⁽²⁾	± 500	
	Machine model (MM)	± 100	

- (1) JEDEC document JEP155 states that 500-V HBM allows safe manufacturing with a standard ESD control process.
 (2) JEDEC document JEP157 states that 250-V CDM allows safe manufacturing with a standard ESD control process.

8.3 Recommended Operating Conditions

		MIN	MAX	UNIT
Supply voltage, VBAT		2.5	5.2	V
V_{IH}	High-level input voltage, EN	1.3		V
V_{IL}	Low-level input voltage, EN		0.6	V
T_A	Operating free-air temperature	-40	85	$^\circ\text{C}$
T_J	Operating junction temperature	-40	150	$^\circ\text{C}$

8.4 Thermal Information

THERMAL METRIC ⁽¹⁾		TPA2025D1		UNITS
		YZG		
		12 PINS		
$R_{\theta\text{JA}}$	Junction-to-ambient thermal resistance	97.3		$^\circ\text{C/W}$
$R_{\theta\text{JC(top)}}$	Junction-to-case(top) thermal resistance	36.7		
$R_{\theta\text{JB}}$	Junction-to-board thermal resistance	55.9		
Ψ_{JT}	Junction-to-top characterization parameter	13.9		
Ψ_{JB}	Junction-to-board characterization parameter	49.5		

- (1) For more information about traditional and new thermal metrics, see the *IC Package Thermal Metrics* application report, [SPRA953](#).

8.5 Electrical Characteristics

VBAT = 3.6 V, T_A = 25°C, R_L = 8 Ω + 33 μH (unless otherwise noted)

PARAMETER	TEST CONDITIONS	MIN	TYP	MAX	UNIT
VBAT supply voltage range		2.5		5.2	V
Class-D supply voltage range	EN = VBAT, boost converter active		5.75		V
	Boost converter disabled (in bypass mode)	2.5		5.2	
Supply under voltage shutdown			2.2		V
Operating quiescent current	EN = VBAT = 3.6 V		2.0	5	mA
	EN = VBAT = 5.2V		2.5	6	
Shutdown quiescent current	VBAT = 2.5 V to 5.2 V, EN = GND		0.2	1	μA
Input common-mode voltage range	IN+, IN–	0.6		1.3	V
Start-up time			6	10	ms

8.6 Operating Characteristics

VBAT = 3.6 V, EN = VBAT, AGC = GND, T_A = 25°C, R_L = 8 Ω + 33 μH (unless otherwise noted)

PARAMETER	TEST CONDITIONS	MIN	TYP	MAX	UNIT	
BOOST CONVERTER						
PVDD Boost converter output voltage range	I _{BOOST} = 0 mA	5.4	5.75	6.4	V	
	I _{BOOST} = 700 mA		5.6		V	
I _L	Boost converter input current limit	Power supply current			mA	
	Boost converter start-up current limit	Boost converter starts up from full shutdown				
		Boost converter wakes up from auto-pass through mode				
f _{BOOST} Boost converter frequency			1.2		MHz	
CLASS-D AMPLIFIER						
P _O Output power	THD = 1%, VBAT = 2.5 V, f = 1 kHz		1440			
	THD = 1%, VBAT = 3.0 V, f = 1 kHz		1750			
	THD = 1%, VBAT = 3.6 V, f = 1 kHz		1900			
	THD = 1%, VBAT = 2.5 V, f = 1 kHz, R _L = 4 Ω + 33 μH		1460			
	THD = 1%, VBAT = 3.0 V, f = 1 kHz, R _L = 4 Ω + 33 μH		1800			
	THD = 1%, VBAT = 3.6 V, f = 1 kHz, R _L = 4 Ω + 33 μH		2280			
V _O Peak output voltage	THD = 1%, VBAT = 3.6 V, f = 1 kHz, 6 dB crest factor sine burst, no clipping		5.45		V	
A _V Voltage gain			19.5	20	20.5	dB
V _{OOS} Output offset voltage			2	10	mV	
Short-circuit protection threshold current				2	A	
R _{IN}	Input impedance (per input pin)		A _V = 20 dB		kΩ	
	Input impedance in shutdown (per input pin)		EN = 0 V			
Z _O Output impedance in shutdown			2		kΩ	
Boost converter auto-pass through threshold		Class-D output voltage threshold when boost converter automatically turns on		2	V _{PK}	
f _{CLASS-D} Class-D switching frequency			275	300	325	kHz
η Class-D and boost combined efficiency	P _O = 1 W, VBAT = 3.6 V		82%			

Operating Characteristics (continued)

VBAT = 3.6 V, EN = VBAT, AGC = GND, TA = 25°C, RL = 8 Ω + 33 μH (unless otherwise noted)

PARAMETER		TEST CONDITIONS	MIN	TYP	MAX	UNIT
EN	Noise output voltage	A-weighted		49		μVRMS
		Unweighted		65		
SNR	Signal-to-noise ratio	1.7 W, RL = 8 Ω + 33 μH. A-weighted		97		dB
		1.7 W, RL = 8 Ω + 33 μH. Unweighted		95		
		2 W, RL = 4 Ω + 33 μH. A-weighted		95		
		2 W, RL = 4 Ω + 33 μH. Unweighted		93		
THD+N	Total harmonic distortion plus noise ⁽¹⁾	PO = 100 mW, f = 1 kHz		0.06%		
		PO = 500 mW, f = 1 kHz		0.07%		
		PO = 1.7 W, f = 1 kHz, RL = 8 Ω + 33 μH		0.07%		
		PO = 2 W, f = 1 kHz, RL = 4 Ω + 33 μH		0.15%		
	THD+N added to other audio signal connected at amplifier input during shutdown			0.02%		
AC PSRR	AC-Power supply ripple rejection (output referred)	200 mVPP square ripple, VBAT = 3.8 V, f = 217 Hz		62.5		dB
		200 mVPP square ripple, VBAT = 3.8 V, f = 1 kHz		62.5		
AC CMRR	AC-Common mode rejection ratio (output referred)	200 mVPP square ripple, VBAT = 3.8 V, f = 217 Hz		71		dB
		200 mVPP square ripple, VBAT = 3.8 V, f = 1 kHz		71		
AUTOMATIC GAIN CONTROL						
	AGC maximum attenuation			10		dB
	AGC attenuation resolution			0.5		dB
	AGC attack time (gain decrease)			20		μs/dB
	AGC release time (gain increase)			1.6		s/dB
	Gain vs VBAT slope	VBAT < inflection point		7.5		dB/V
	AGC inflection point (Note: AGC pin voltage is read only at device power-up. A device power cycle is required to change AGC inflection points.)	AGC = Float		3.25		V
		AGC = GND		3.55		
		AGC = VBAT		3.75		

(1) A-weighted

8.7 Typical Characteristics

VBAT = 3.6 V, C_I = 1 μF, C_{BOOST} = 22 μF, L_{BOOST} = 2.2 μH, EN = VBAT, and Load = 8 Ω + 33 μH, no ferrite bead unless otherwise specified.

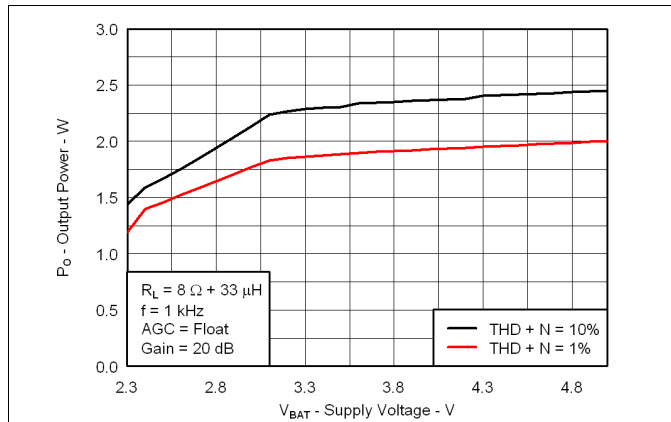

Figure 1. Output Power vs Supply Voltage

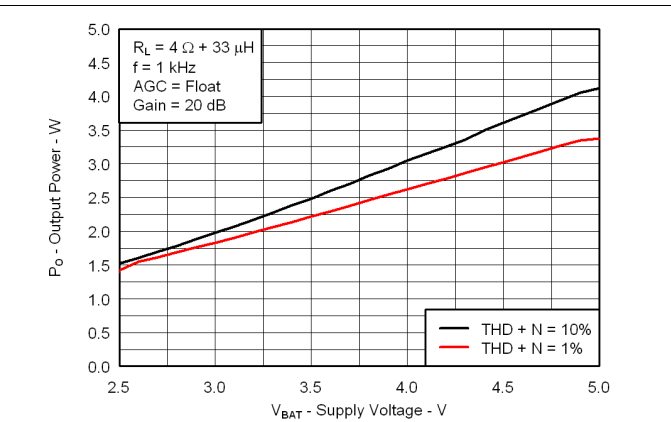

Figure 2. Output Power vs Supply Voltage

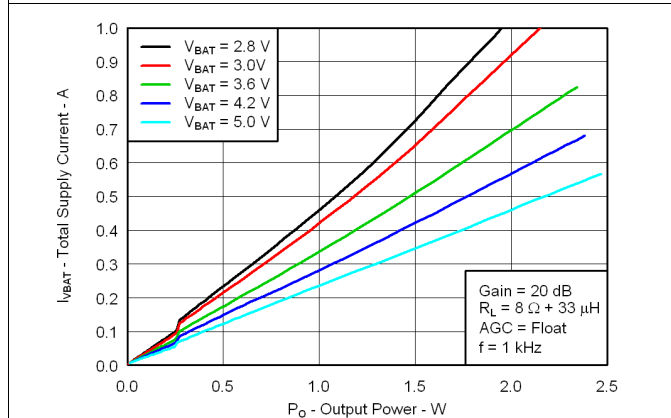

Figure 3. Total Supply Current vs Output Power

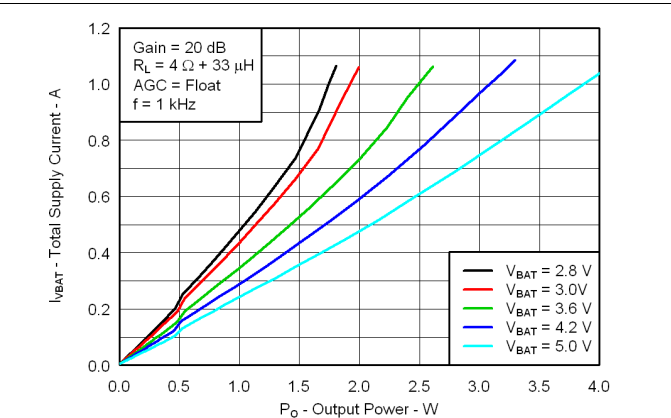

Figure 4. Total Supply Current vs Output Power

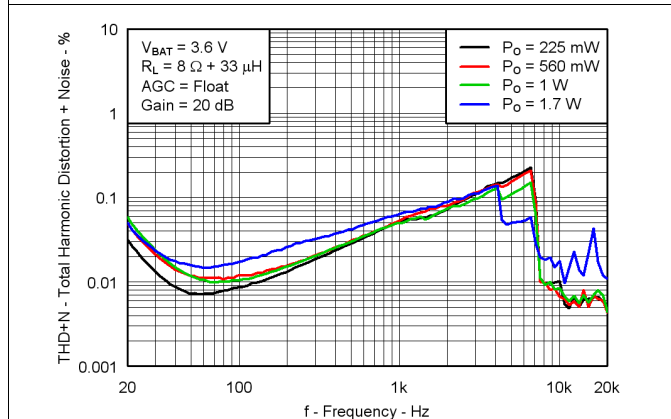

Figure 5. Total Harmonic Distortion + Noise vs Frequency

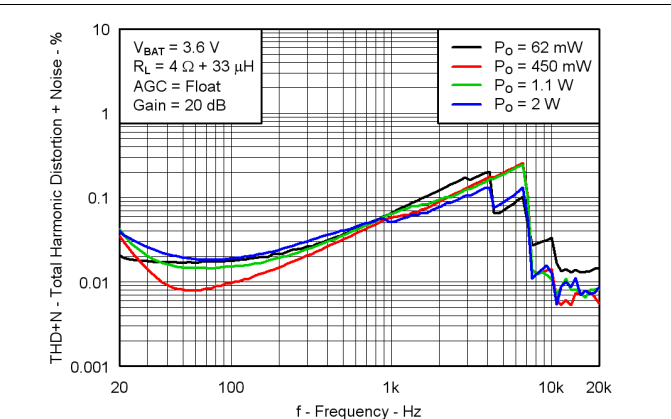
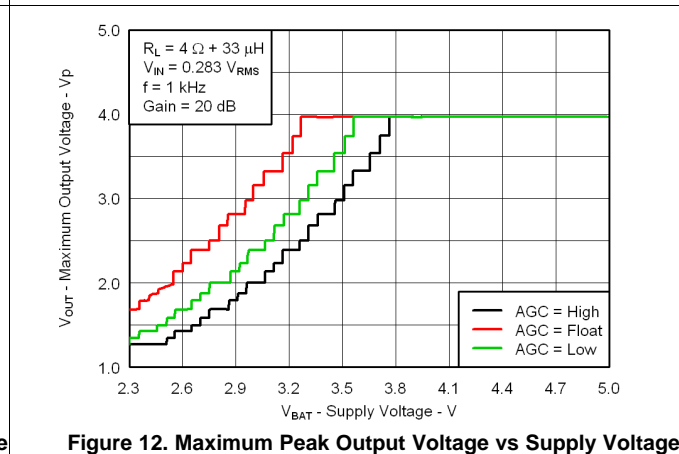
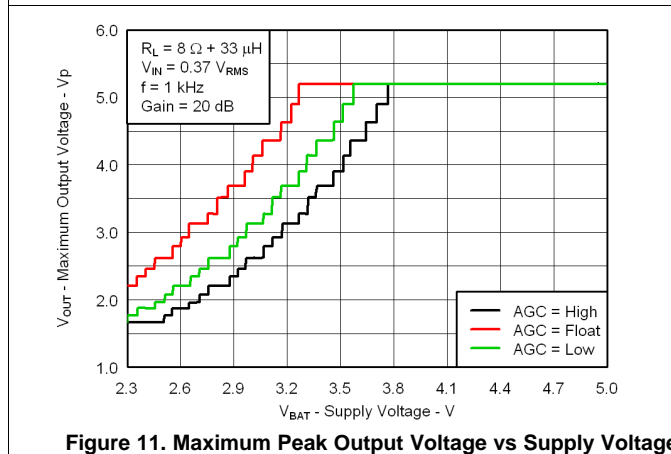
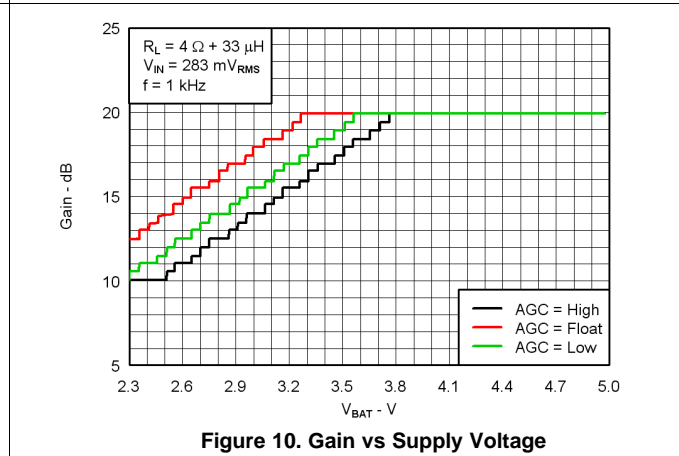
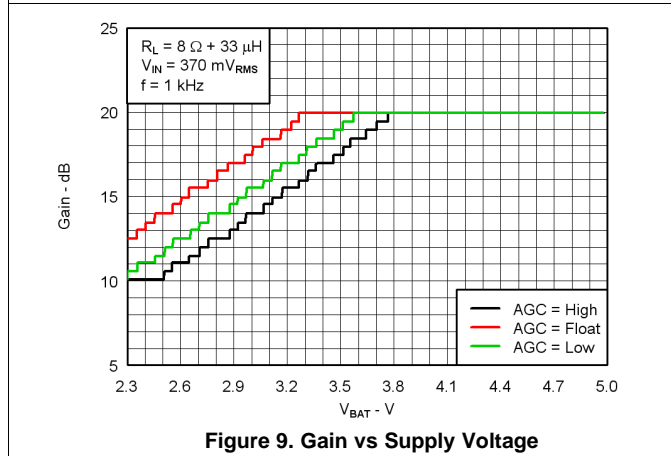
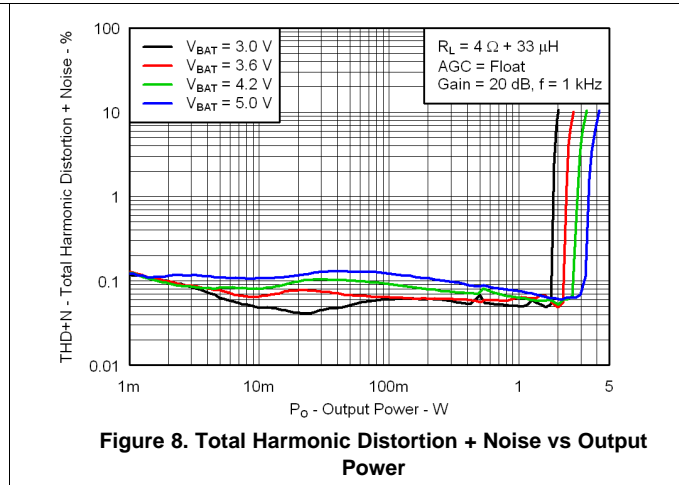
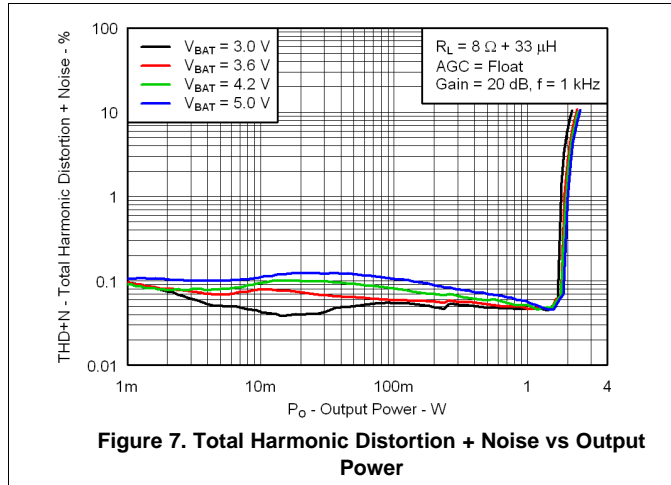

Figure 6. Total Harmonic Distortion + Noise vs Frequency

Typical Characteristics (continued)

VBAT = 3.6 V, C₁ = 1 μF, C_{BOOST} = 22 μF, L_{BOOST} = 2.2 μH, EN = VBAT, and Load = 8 Ω + 33 μH, no ferrite bead unless otherwise specified.



Typical Characteristics (continued)

V_{BAT} = 3.6 V, C₁ = 1 μF, C_{BOOST} = 22 μF, L_{BOOST} = 2.2 μH, EN = V_{BAT}, and Load = 8 Ω + 33 μH, no ferrite bead unless otherwise specified.

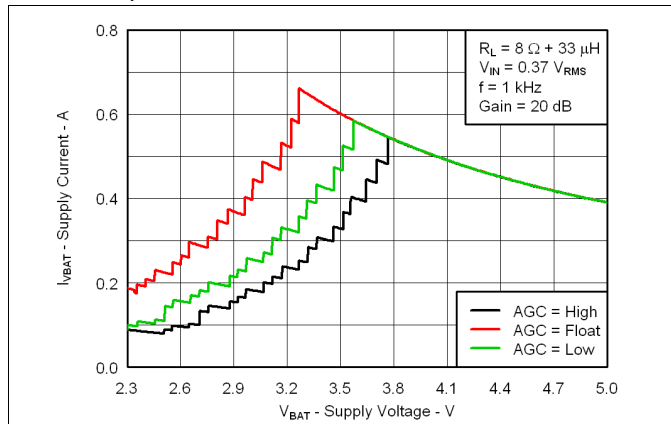

Figure 13. Supply Current vs Supply Voltage

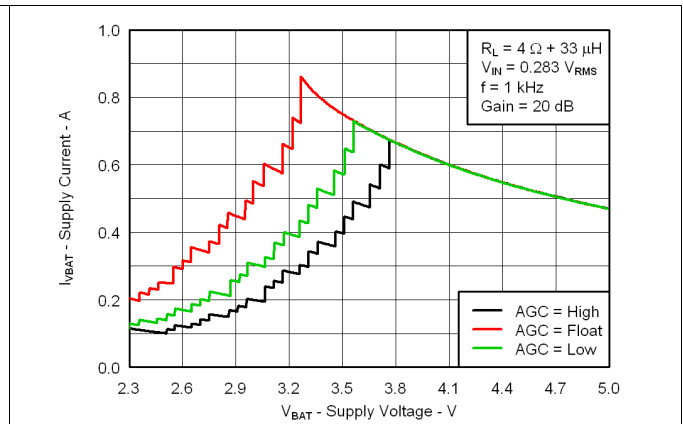

Figure 14. Supply Current vs Supply Voltage

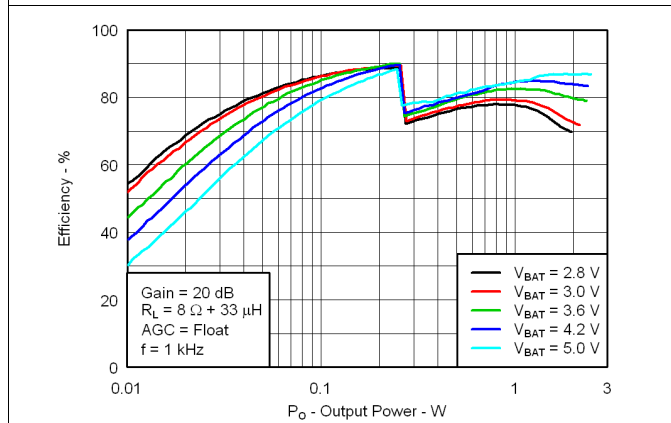

Figure 15. Total Efficiency vs Output Power

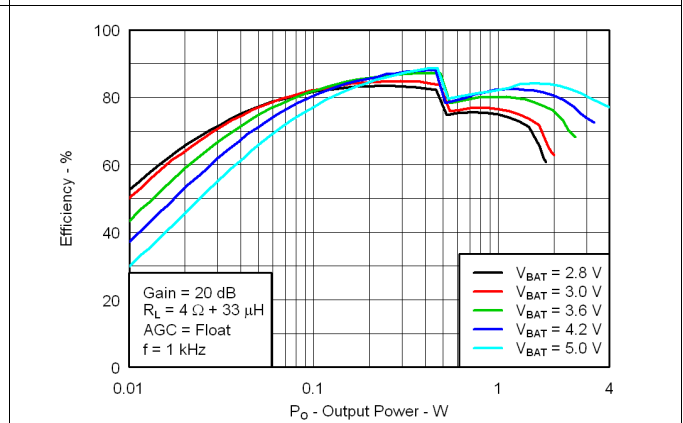

Figure 16. Total Efficiency vs Output Power

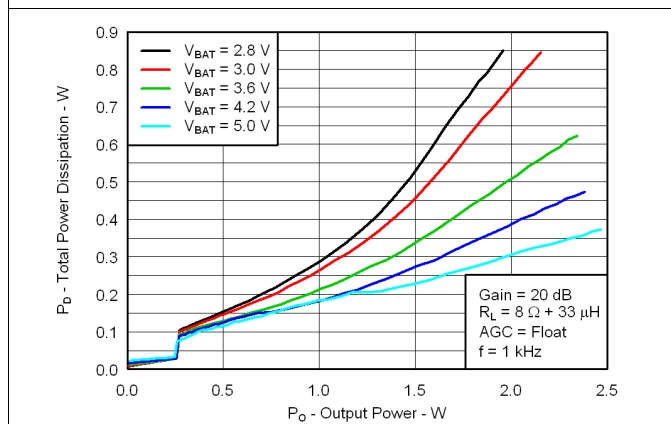

Figure 17. Total Power Dissipation vs Output Power

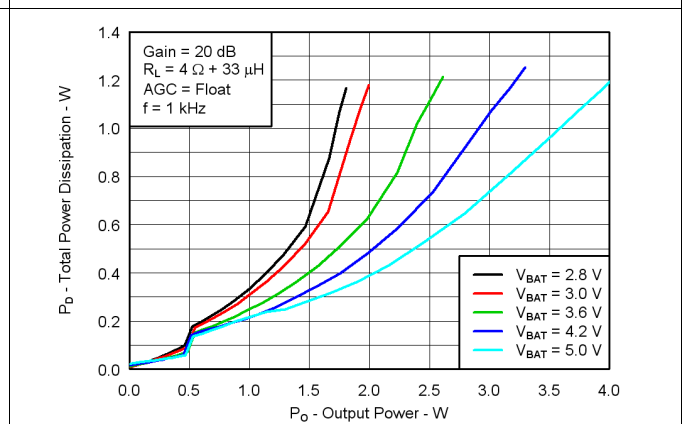
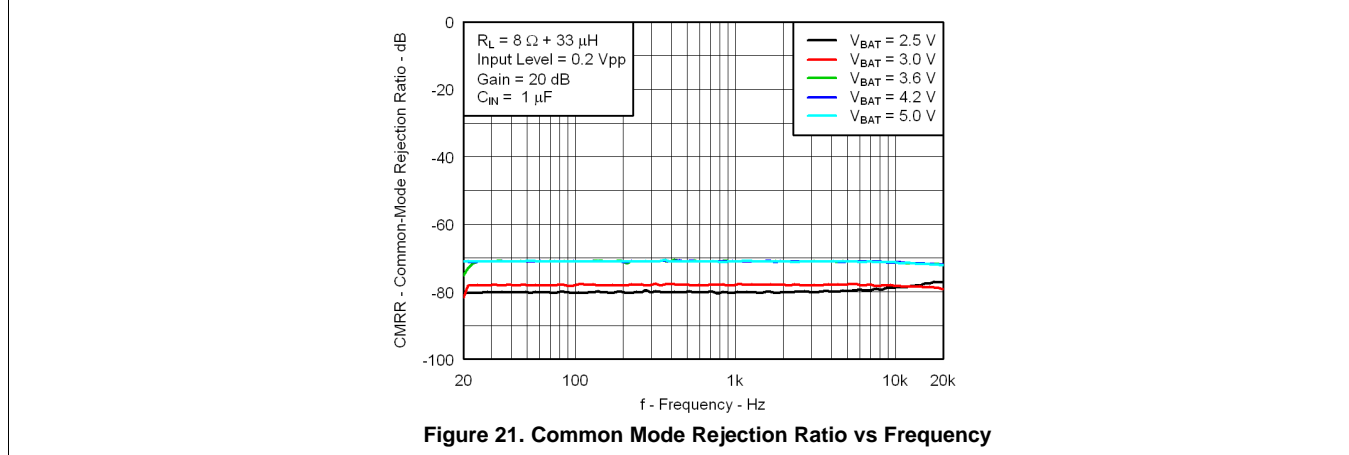
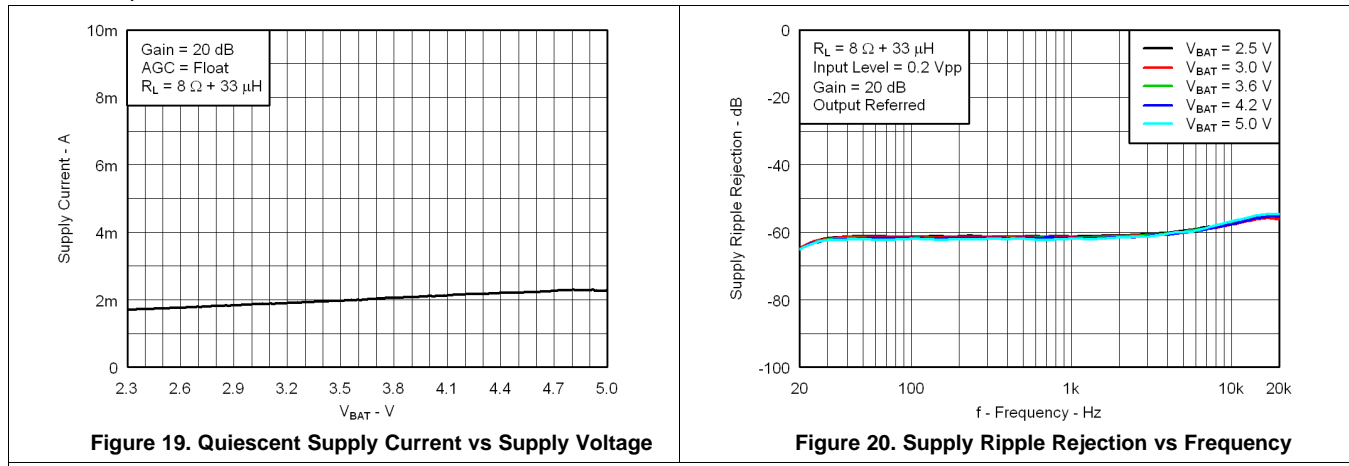

Figure 18. Total Power Dissipation vs Output Power

Typical Characteristics (continued)

V_{BAT} = 3.6 V, C_I = 1 μF, C_{BOOST} = 22 μF, L_{BOOST} = 2.2 μH, EN = V_{BAT}, and Load = 8 Ω + 33 μH, no ferrite bead unless otherwise specified.



9 Parameter Measurement Information

All parameters are measured according to the conditions described in the [Specifications](#) section.

Many audio analyzers will not give the correct readings on a Class-D amplifier without additional filtering, even if they have an internal low-pass filter. A RC 30kHz low-pass filter (100-Ω, 47n-F) is implemented to reduce the remaining noise frequencies from the PWM carrier signal. This filter was used on each output for the data sheet graphs.

10 Detailed Description

10.1 Overview

The TPA2025D1 is a constant output, high efficiency Class-D audio amplifier with battery tracking AGC technology and an integrated Class-G boost converter. This features give the device a great performance and enhances efficiency at low output power. The TPA2025D1 can drive up to 1.9 W into an 8-Ω speaker (1% THD+N).

The built-in boost converter operates from a battery supply voltage and generates a higher output voltage PVDD at 5.75 V that drives the supply voltage of the Class-D amplifier. This provides a louder audio output than a stand-alone amplifier directly connected to the battery.

The battery tracking AGC adjusts the Class-D gain to limit battery current at lower battery voltage. This lets the device to extend the battery life while playing audio, typically with 85% efficiency. When the battery voltage is below a certain threshold voltage, The TPA2025D1 lowers the audio loudness. The threshold is selectable with an external pin.

The TPA2025D1 has an integrated low-pass filter to improve the RF rejection and reduce DAC out-of-band noise, increasing the signal-to-noise ratio (SNR). The features included in this device allow it to be used in a wide range of portable applications.

10.2 Functional Block Diagram

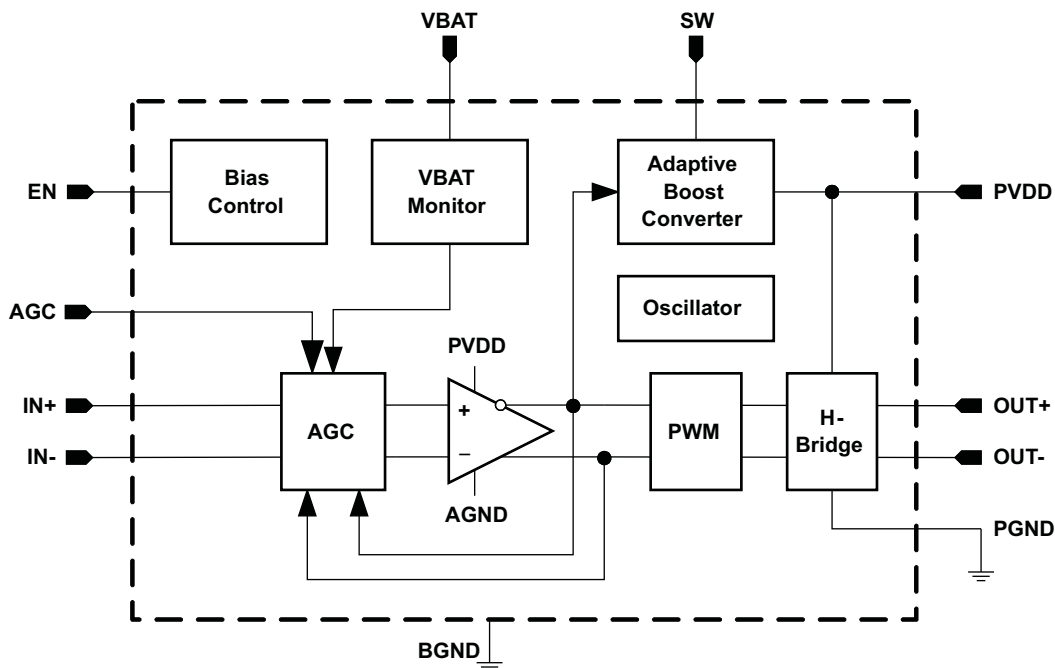

10.3 Feature Description

10.3.1 Battery Tracking Automatic Gain Control (AGC)

TPA2025D1 monitors the battery voltage and automatically reduces the gain when the battery voltage is below a certain threshold voltage, which is defined as inflection point. Although battery tracking AGC lowers the audio loudness, it prevents high battery current at end-of-charge battery voltage. The inflection point is selectable at AGC pin. When the amplifier is turned on, the gain is set according to battery voltage and selected inflection point.

Figure 22 shows the plot of gain as a function of battery supply voltage. The default slope is 7.5 dB/V. When battery voltage drops below inflection point by 1 V, AGC reduces the gain by 7.5 dB. The TPA2025D1 can only operate at one slope.

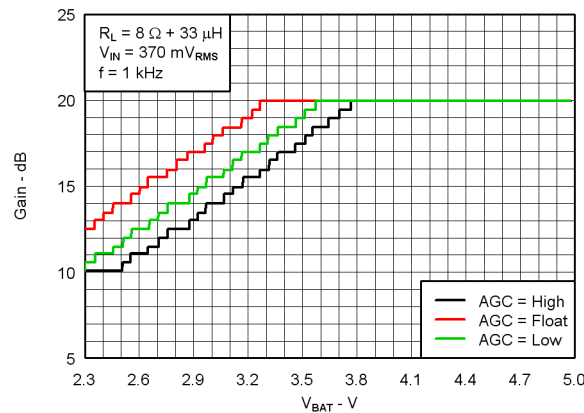

Figure 22. Gain vs Battery voltage

10.3.2 Boost Converter Auto Pass Through (APT)

The TPA2025D1 consists of an adaptive boost converter and a Class-D amplifier. The boost converter operates from the supply voltage, V_{BAT}, and generates a higher output voltage PVDD at 5.75 V. PVDD drives the supply voltage of the Class-D amplifier. This improves loudness over non-boosted solutions. The boost converter has a “Pass Through” mode in which it turns off automatically and PVDD is directly connected to V_{BAT} through an internal bypass switch.

The boost converter is adaptive and operates between pass through mode and boost mode depending on the output audio signal amplitude. When the audio output amplitude exceeds the “auto pass through” (APT) threshold, the boost converter is activated automatically and goes to boost mode. The transition time from normal mode to boost mode is less than 3 ms. TPA2025D1’s APT threshold is fixed at 2 V_{pk}. When the audio output signal is below APT threshold, the boost converter is deactivated and goes to pass through mode. The adaptive boost converter maximizes system efficiency in lower audio output level.

The battery AGC is independent of APT threshold. The AGC operates in both boost-active and APT modes.

Figure 23 shows how the adaptive boost converter behaves with a typical audio signal.

Feature Description (continued)

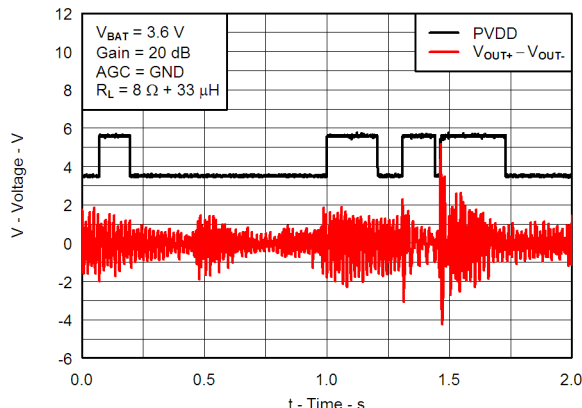

Figure 23. Adaptive Boost Converter with Typical Music Playback

10.3.3 Short Circuit Auto-Recovery

When a short circuit event happens, the TPA2025D1 goes to low duty cycle mode and tries to reactivate itself every 1.6 seconds. This auto-recovery continues until the short circuit event stops. This feature protects the device without affecting its long term reliability.

10.3.4 Thermal Protection

It is important to operate the TPA2025D1 at temperatures lower than its maximum operating temperature. The maximum ambient temperature depends on the heat-sinking ability of the PCB system. Given θ_{JA} of 97.3°C/W, the maximum allowable junction temperature of 150°C, and the internal dissipation of 0.5 W for 1.9 W, 8 Ω load, 3.6 V supply, the maximum ambient temperature is calculated as:

$$T_{A,MAX} = T_{J,MAX} - \theta_{JA} P_D = 150^{\circ}\text{C} - (97.3^{\circ}\text{C/W} \times 0.5\text{W}) = 101.4^{\circ}\text{C}$$

The calculated maximum ambient temperature is 101.4°C at maximum power dissipation at 3.6 V supply and 8 Ω load. The TPA2025D1 is designed with thermal protection that turns the device off when the junction temperature surpasses 150°C to prevent damage to the IC.

10.3.5 Operation with DACs and Codecs

Large noise voltages can be present at the output of $\Delta\Sigma$ DACs and CODECs, just above the audio frequency (e.g: 80 kHz with a 300 mV_{P-P}). This out-of-band noise is due to the noise shaping of the delta-sigma modulator in the DAC. Some Class-D amplifiers have higher output noise when used in combination with these DACs and CODECs. This is because out-of-band noise from the CODEC/DAC mixes with the Class-D switching frequencies in the audio amplifier input stage. The TPA2025D1 has a built-in low-pass filter with cutoff frequency at 55 kHz that reduces the out-of-band noise and RF noise, filtering out-of-band frequencies that could degrade in-band noise performance. This built-in filter also prevents AGC errors due to out-of-band noise. The TPA2025D1 AGC calculates gain based on input signal amplitude only. If driving the TPA2025D1 input with 4th-order or higher $\Delta\Sigma$ DACs or CODECs, add an R-C low pass filter at each of the audio inputs (IN+ and IN-) of the TPA2025D1 to ensure best performance. The recommended resistor value is 100 Ω and the capacitor value of 47 nF.

10.4 Device Functional Modes

10.4.1 Operation Below AGC Threshold

When the battery power supply voltage is below a certain threshold voltage, the TPA2025D1 starts reducing the gain automatically. This AGC threshold is selected by external AGC pin at 3.25 V, 3.55 V and 3.75 V for FLOAT, LOW and HIGH levels respectively.

Figure 24 shows the operation of AGC in time domain.

Device Functional Modes (continued)

Figure 24. Relationship Between Supply Voltage and Gain in Time Domain

- Phase 1 Battery discharging normally; supply voltage is above inflection point; audio gain remains at 20 dB.
- Phase 2 Battery voltage decreases below inflection point. AGC responds in 10 μ s and reduces gain by one step (0.5 dB)
- Phase 3 Battery voltage continues to decrease. AGC continues to reduce gain. The rate of gain decrease is defined as attack time. TPA2025D1's attack time is 20 μ s/dB.
- Phase 4 Battery voltage is constant. AGC stops reducing gain.
- Phase 5 Battery voltage decreases suddenly. AGC reduces gain multiple steps. (time scale from this phase is longer) Release time counter resets every end of attack event.
- Phase 6 Release time has elapsed. Battery voltage returns to previous level. AGC increases gain by one step. TPA2025D1's release time is 1.6 s/dB
- Phase 7 Battery voltage remains constant. AGC continues to increase gain until it reaches steady state gain value defined in [Figure 22](#).
- Phase 8 Battery voltage is recharged to above inflection point. AGC continues to increase gain until it reaches 20 dB.

10.4.2 Shutdown Mode

The TPA2025D1 can be put in shutdown mode when asserting EN pin to a logic LOW. While in shutdown mode, the device output stage is turned off and the current consumption is very low. The device exits shutdown mode when a HIGH logic level is applied to EN pin.

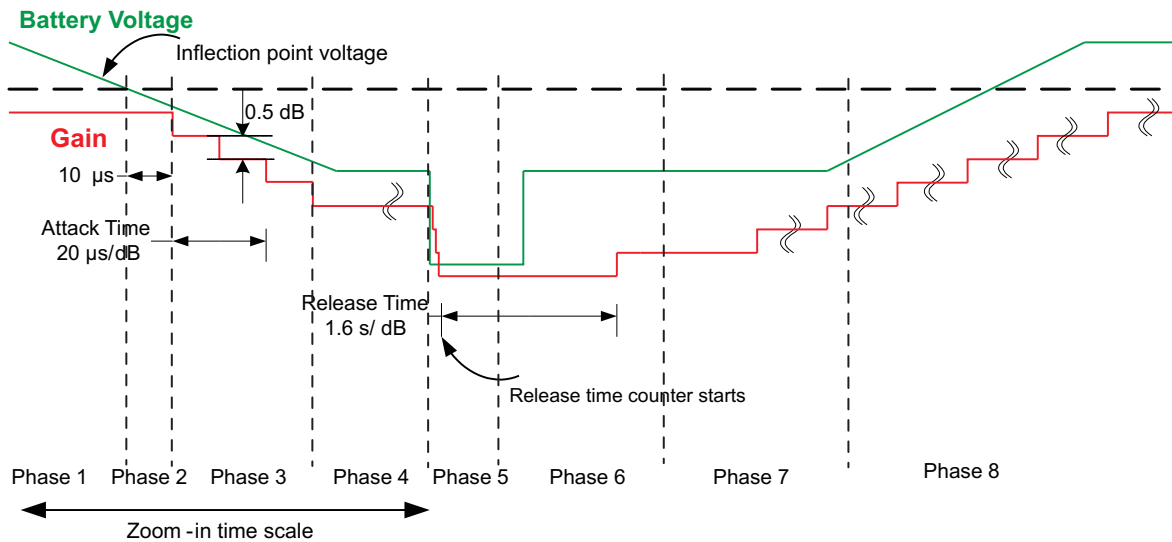
11 Application and Implementation

NOTE

Information in the following applications sections is not part of the TI component specification, and TI does not warrant its accuracy or completeness. TI's customers are responsible for determining suitability of components for their purposes. Customers should validate and test their design implementation to confirm system functionality.

11.1 Application Information

The TPA2025D1 is a Class D amplifier with integrated automatic gain control and boost converter. This device is capable of drive up to 1.9W to 8-Ω Speaker (1% THD+N). TPA2025D1 starts operating when setting EN pin to HIGH level. The device enters in shutdown mode when asserting EN to LOW level. AGC pin connection sets the threshold where the device will start reducing the output amplitude. The selectable threshold voltages are specified in the [Operating Characteristics](#) section. In order to measure the TPA2025D1 output with an analyzer, a 30KHz Low pass filter should be implemented.

11.2 Typical Application

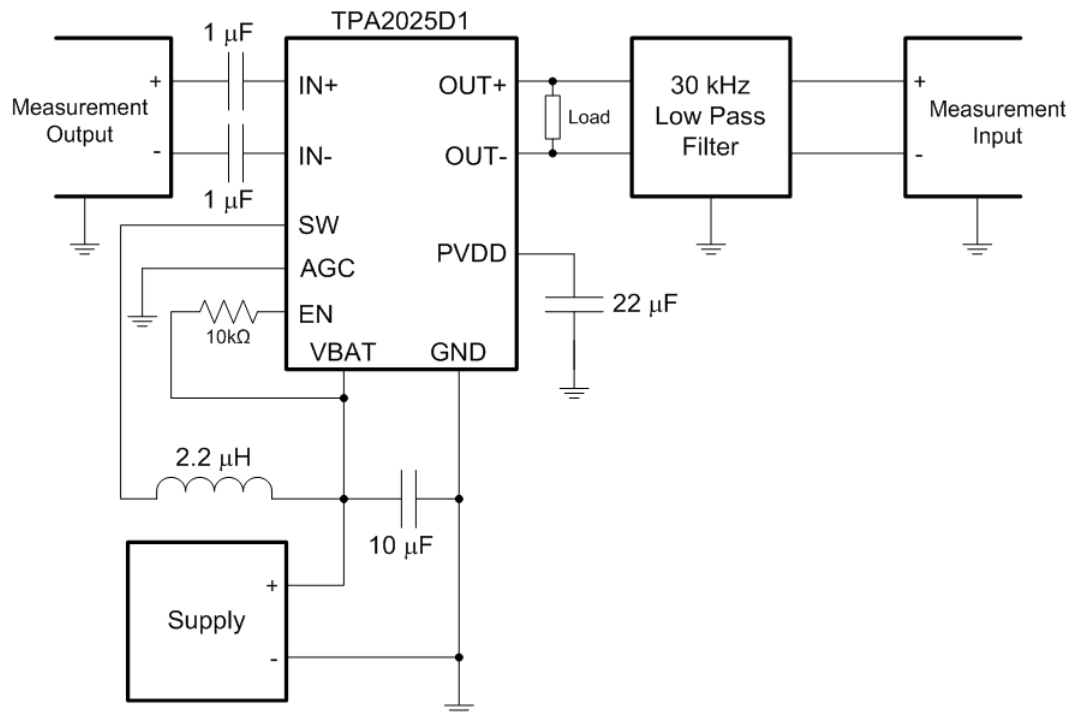

- (1) The 1- μ F input capacitors on IN+ and IN- were shorted for input common-mode voltage measurements.
- (2) A 33- μ H inductor was placed in series with the load resistor to emulate a small speaker for efficiency measurements.
- (3) The 30-kHz low-pass filter is required even if the analyzer has an internal low-pass filter. An R-C low-pass filter (100 Ω , 47 nF) is used on each output for the data sheet graphs.

Figure 25. Typical Application Schematic

Typical Application (continued)

11.2.1 Design Requirements

For this design example, use the parameters listed in [Table 1](#).

Table 1. Design Parameters

PARAMETER	VALUE
Supply voltage range	2.5 V - 5.2 V
Input voltage range	0 V - 5 V
Peak output voltage	5.45 V
Max output current	1.8 A

11.2.2 Detailed Design Procedure

11.2.2.1 Boost Converter Component Section

The critical external components are summarized in the following table:

PARAMETER	TEST CONDITIONS	MIN	TYP	MAX	UNIT
Boost converter inductor	At 30% rated DC bias current of the inductor	1.5	2.2	4.7	μH
Boost converter input capacitor		4.7		10	μF
Boost converter output capacitor	Working capacitance biased at boost output voltage, if 4.7μH inductor is chosen, then minimum capacitance is 10 μF	4.7		22	μF

11.2.2.1.1 Inductor Equations

Inductor current rating is determined by the requirements of the load. The inductance is determined by two factors: the minimum value required for stability and the maximum ripple current permitted in the application. Use [Equation 1](#) to determine the required current rating. [Equation 1](#) shows the approximate relationship between the average inductor current, I_L , to the load current, load voltage, and input voltage (I_{PVDD} , $PVDD$, and $VBAT$, respectively). Insert I_{PVDD} , $PVDD$, and $VBAT$ into Equation 1 and solve for I_L . The inductor must maintain at least 90% of its initial inductance value at this current.

$$I_L = I_{PVDD} \times \left(\frac{PVDD}{VBAT \times 0.8} \right) \quad (1)$$

Ripple current, ΔI_L , is peak-to-peak variation in inductor current. Smaller ripple current reduces core losses in the inductor and reduces the potential for EMI. Use [Equation 2](#) to determine the value of the inductor, L . [Equation 2](#) shows the relationship between inductance L , $VBAT$, $PVDD$, the switching frequency, f_{BOOST} , and ΔI_L . Insert the maximum acceptable ripple current into [Equation 2](#) and solve for L .

$$L = \frac{VBAT \times (PVDD - VBAT)}{\Delta I_L \times f_{BOOST} \times PVDD} \quad (2)$$

ΔI_L is inversely proportional to L . Minimize ΔI_L as much as is necessary for a specific application. Increase the inductance to reduce the ripple current. Do not use greater than 4.7 μH, as this prevents the boost converter from responding to fast output current changes properly. If using above 3.3 μH, then use at least 10 μF capacitance on $PVDD$ to ensure boost converter stability.

The typical inductor value range for the TPA2025D1 is 2.2 μH to 3.3 μH. Select an inductor with less than 0.5 Ω dc resistance, DCR. Higher DCR reduces total efficiency due to an increase in voltage drop across the inductor.

Table 2. Sample Inductors

L (μH)	SUPPLIER	COMPONENT CODE	SIZE (LxWxH mm)	DCR TYP (mΩ)	I _{SAT} MAX (A)	C RANGE
2.2	Toko	1239AS-H-2R2N=P2	2.5 x 2.0 x 1.2	96	2.3	4.7 - 22 μF / 16 V 6.8 - 22 μV / 10 V
2.2	Coilcraft	XFL4020-222MEC	4.0 x 4.0 x 2.15	22	3.5	
3.3	Toko	1239AS-H-3R3N=P2	2.5 x 2.0 x 1.2	160	2.0	10 - 22 μF / 10 V
3.3	Coilcraft	XFL4020-332MEC	4.0 x 4.0 x 2.15	35	2.8	

11.2.2.1.2 Boost Converter Capacitor Selection

The value of the boost capacitor is determined by the minimum value of working capacitance required for stability and the maximum voltage ripple allowed on PVDD in the application. Working capacitance refers to the available capacitance after derating the capacitor value for DC bias, temperature, and aging. Do not use any component with a working capacitance less than 4.7 μF. This corresponds to a 4.7 μF/16 V capacitor, or a 6.8 μF/10 V capacitor.

Do not use above 22 μF capacitance as it will reduce the boost converter response time to large output current transients.

[Equation 3](#) shows the relationship between the boost capacitance, C, to load current, load voltage, ripple voltage, input voltage, and switching frequency (I_{PVDD}, PVDD, ΔV, VBAT, and f_{BOOST} respectively).

Insert the maximum allowed ripple voltage into [Equation 3](#) and solve for C. The 1.5 multiplier accounts for capacitance loss due to applied dc voltage and temperature for X5R and X7R ceramic capacitors.

$$C = 1.5 \times \frac{I_{PVDD} \times (PVDD - VBAT)}{\Delta V \times f_{BOOST} \times PVDD} \quad (3)$$

11.2.2.1.3 Boost Terms

The following is a list of terms and definitions used in the boost equations.

C	Minimum boost capacitance required for a given ripple voltage on PVDD.
L	Boost inductor
f _{BOOST}	Switching frequency of the boost converter.
I _{PVDD}	Current pulled by the Class-D amplifier from the boost converter.
I _L	Average current through the boost inductor.
PVDD	Supply voltage for the Class-D amplifier. (Voltage generated by the boost converter output)
VBAT	Supply voltage to the IC.
ΔI _L	Ripple current through the inductor.
ΔV	Ripple voltage on PVDD.

11.2.2.2 Input Capacitors

Input audio DC decoupling capacitors are recommended. The input audio DC decoupling capacitors prevents the AGC from changing the gain due to audio DAC output offset. The input capacitors and TPA2025D1 input impedance form a high-pass filter with the corner frequency, f_c, determined in [Equation 4](#).

Any mismatch in capacitance between the two inputs will cause a mismatch in the corner frequencies. Severe mismatch may also cause turn-on pop noise. Choose capacitors with a tolerance of ±10% or better.

$$f_c = \frac{1}{(2 \times \pi \times R_i C_i)} \quad (4)$$

11.2.2.3 Speaker Load Limitation

Speakers are non-linear loads with varying impedance (magnitude and phase) over the audio frequency. A portion of speaker load current can flow back into the boost converter output via the Class-D output H-bridge high-side device. This is dependent on the speaker's phase change over frequency, and the audio signal amplitude and frequency content. Most portable speakers have limited phase change at the resonant frequency, typically no more than 40 or 50 degrees. To avoid excess flow-back current, use speakers with limited phase change. Otherwise, flow-back current could drive the PVDD voltage above the absolute maximum recommended operational voltage.

Confirm proper operation by connecting the speaker to the TPA2025D1 and driving it at maximum output swing. Observe the PVDD voltage with an oscilloscope. In the unlikely event the PVDD voltage exceeds 6.5 V, add a 6.8 V Zener diode between PVDD and ground to ensure the TPA2025D1 operates properly. The amplifier has thermal overload protection and deactivates if the die temperature exceeds 150°C. It automatically reactivates once die temperature returns below 150°C. Built-in output over-current protection deactivates the amplifier if the speaker load becomes short-circuited. The amplifier automatically restarts 1.6 seconds after the over-current event. Although the TPA2025D1 Class-D output can withstand a short between OUT+ and OUT-, do not connect either output directly to GND, VDD, or VBAT as this could damage the device.

11.2.3 Application Curve

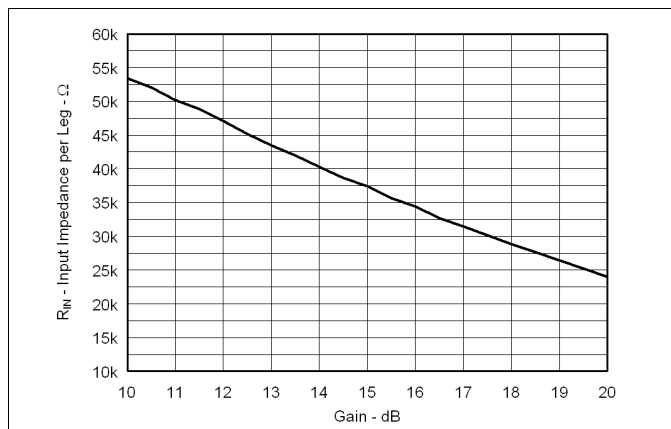

Figure 26. Input Impedance vs Gain

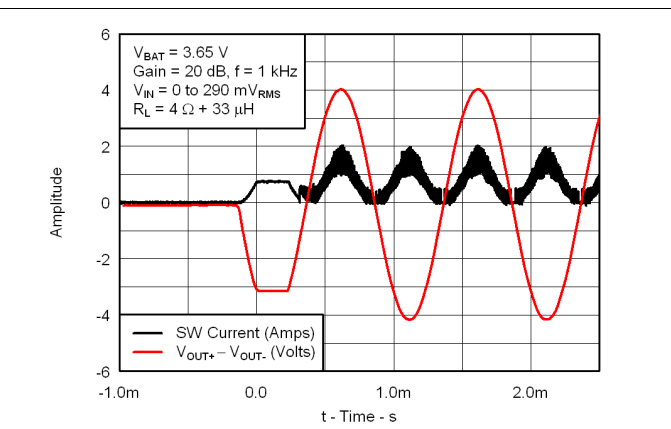

Figure 27. Boost Startup Current vs Time

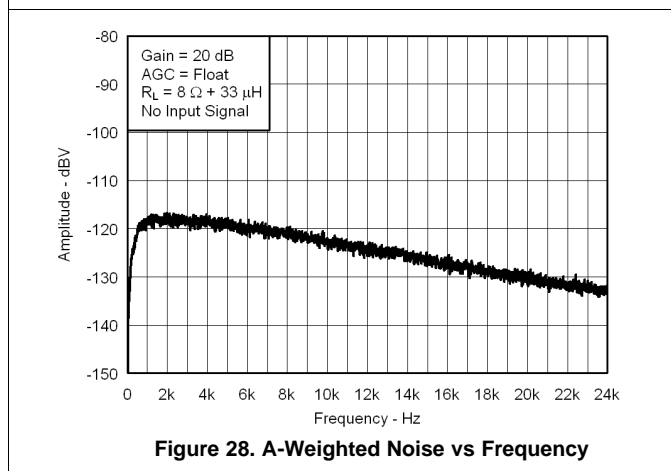

Figure 28. A-Weighted Noise vs Frequency

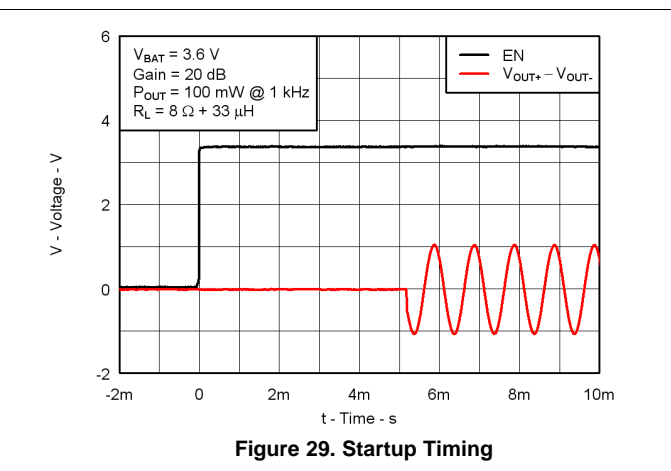

Figure 29. Startup Timing

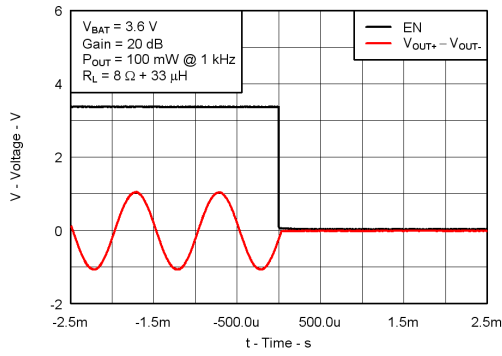

Figure 30. Shutdown Timing

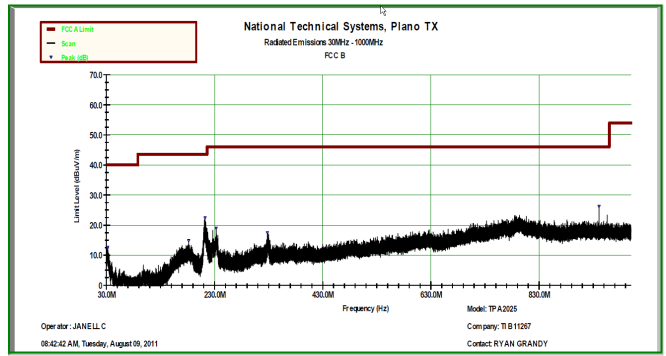

Figure 31. EMC Performance $P_o = 750\text{ mW}$ with 2 Inch Speaker Cable

12 Power Supply Recommendations

The TPA2025D1 is designed to operate from an input voltage supply range between 2.5-V and 5.2-V. Therefore, the output voltage range of power supply should be within this range and well regulated. The current capability of upper power should not exceed the maximum current limit of the power switch.

12.1 Power Supply Decoupling Capacitors

The TPA2025D1 is a high-performance Class-D audio amplifier that requires adequate power supply decoupling. Adequate power supply decoupling to ensures that the efficiency is high and total harmonic distortion (THD) is low.

Place a low equivalent-series-resistance (ESR) ceramic capacitor, typically 0.1 μF , within 2 mm of the VBAT ball. This choice of capacitor and placement helps with higher frequency transients, spikes, or digital hash on the line. Additionally, placing this decoupling capacitor close to the TPA2025D1 is important, as any parasitic resistance or inductance between the device and the capacitor causes efficiency loss. In addition to the 0.1 μF ceramic capacitor, place a 2.2 μF to 10 μF capacitor on the VBAT supply trace. This larger capacitor acts as a charge reservoir, providing energy faster than the board supply, thus helping to prevent any droop in the supply voltage.

13 Layout

13.1 Layout Guidelines

Decoupling capacitors should be placed as close to the supply voltage pin as possible. For this device a 10- μF high-quality ceramic capacitor is recommended.

Table 3. Land Pattern Dimensions^{(1) (2) (3) (4)}

SOLDER PAD DEFINITIONS	COPPER PAD	SOLDER MASK ⁽⁵⁾ OPENING	COPPER THICKNESS	STENCIL ^{(6) (7)} OPENING	STENCIL THICKNESS
Nonsolder mask defined (NSMD)	275 μm (+0.0, -25 μm)	375 μm (+0.0, -25 μm)	1 oz max (32 μm)	275 μm x 275 μm Sq. (rounded corners)	125 μm thick

- (1) Circuit traces from NSMD defined PWB lands should be 75 μm to 100 μm wide in the exposed area inside the solder mask opening. Wider trace widths reduce device stand off and impact reliability.
- (2) Best reliability results are achieved when the PWB laminate glass transition temperature is above the operating the range of the intended application.
- (3) Recommend solder paste is Type 3 or Type 4.
- (4) For a PWB using a Ni/Au surface finish, the gold thickness should be less 0.5 μm to avoid a reduction in thermal fatigue performance.
- (5) Solder mask thickness should be less than 20 μm on top of the copper circuit pattern
- (6) Best solder stencil performance is achieved using laser cut stencils with electro polishing. Use of chemically etched stencils results in inferior solder paste volume control.
- (7) Trace routing away from WCSP device should be balanced in X and Y directions to avoid unintentional component movement due to solder wetting forces.

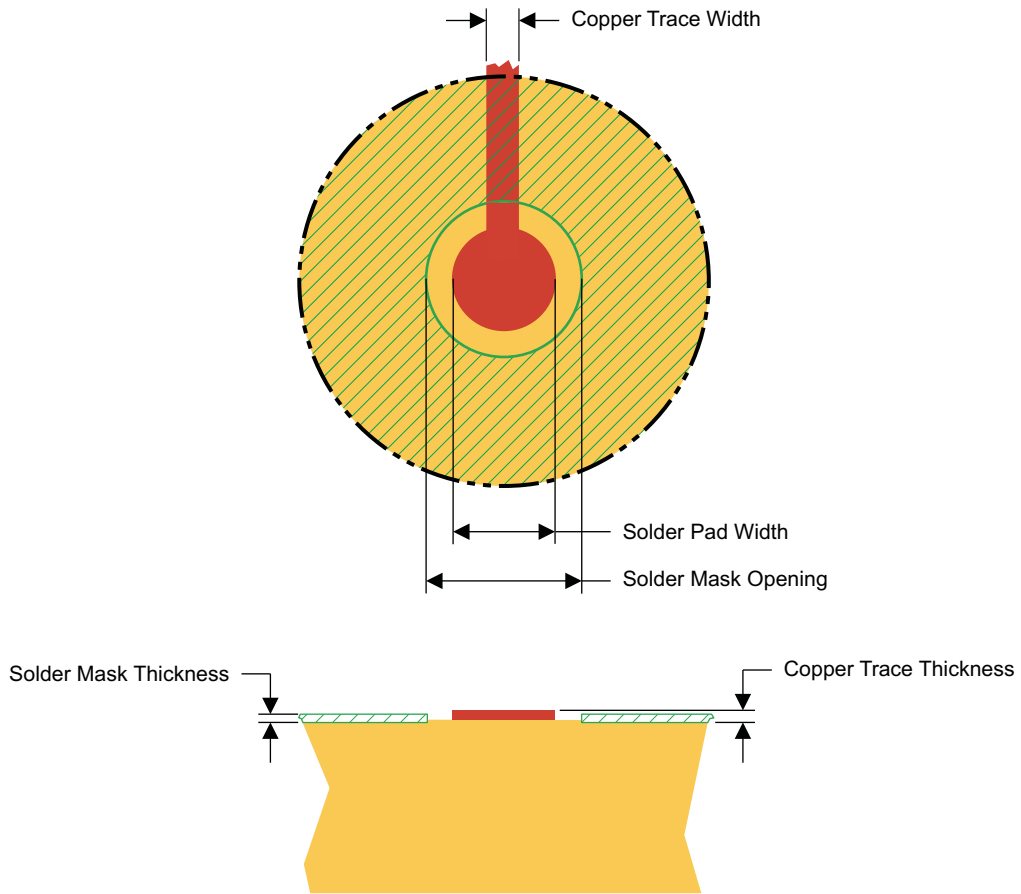

M0200-01

Figure 32. Land Pattern Dimensions

13.2 Layout Example

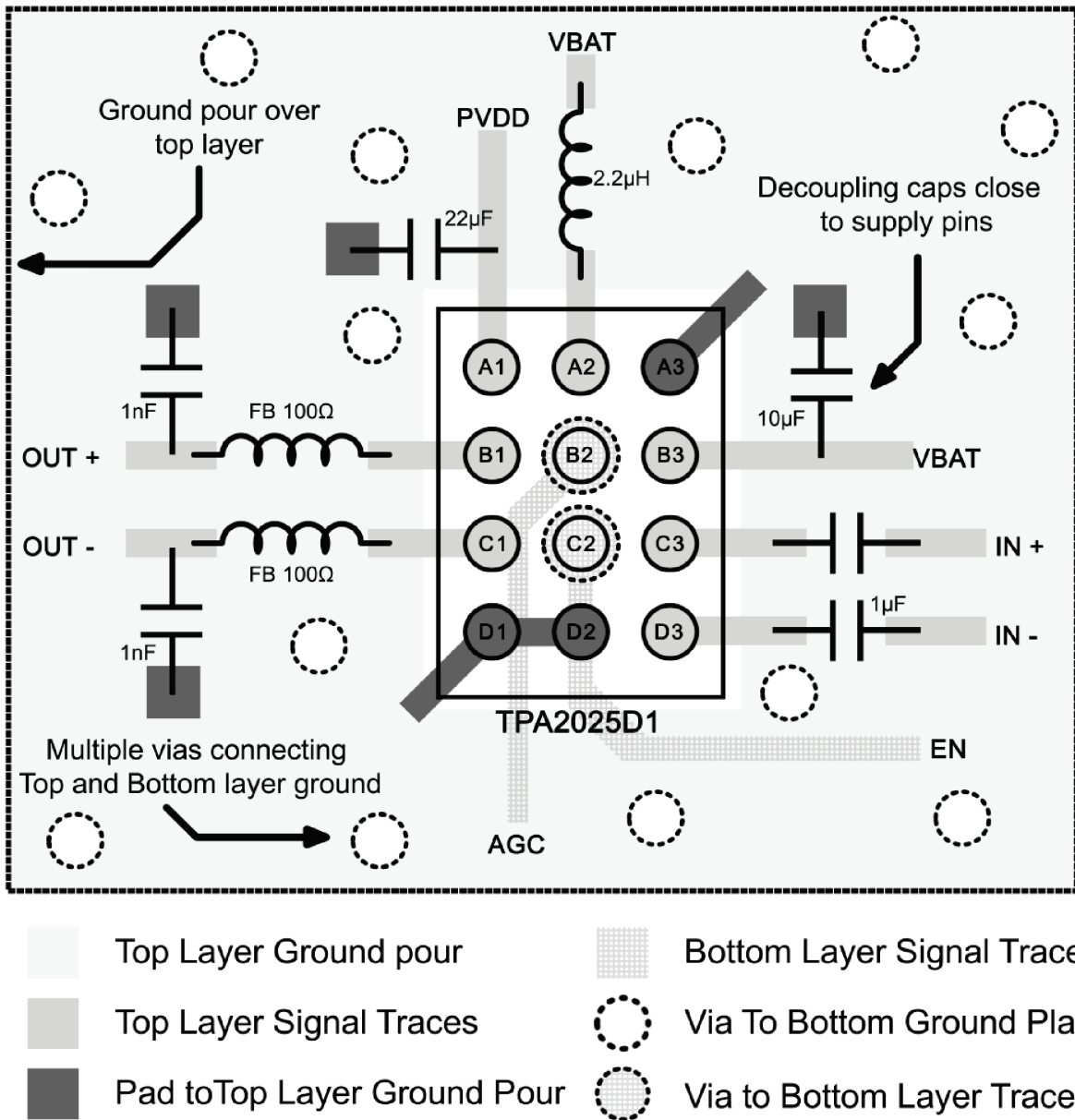

Figure 33. TPA2025D1 Layout Example

14 Device and Documentation Support

14.1 Trademarks

All trademarks are the property of their respective owners.

14.2 Electrostatic Discharge Caution



These devices have limited built-in ESD protection. The leads should be shorted together or the device placed in conductive foam during storage or handling to prevent electrostatic damage to the MOS gates.

14.3 Glossary

[SLYZ022](#) — *TI Glossary*.

This glossary lists and explains terms, acronyms, and definitions.

15 Mechanical, Packaging, and Orderable Information

The following pages include mechanical, packaging, and orderable information. This information is the most current data available for the designated devices. This data is subject to change without notice and revision of this document. For browser-based versions of this data sheet, refer to the left-hand navigation.

PACKAGING INFORMATION

Orderable Device	Status (1)	Package Type	Package Drawing	Pins	Package Qty	Eco Plan (2)	Lead/Ball Finish (6)	MSL Peak Temp (3)	Op Temp (°C)	Device Marking (4/5)	Samples
TPA2025D1YZGR	ACTIVE	DSBGA	YZG	12	3000	Green (RoHS & no Sb/Br)	SNAGCU	Level-1-260C-UNLIM	-40 to 85	TPA2025D1	Samples
TPA2025D1YZGT	ACTIVE	DSBGA	YZG	12	250	Green (RoHS & no Sb/Br)	SNAGCU	Level-1-260C-UNLIM	-40 to 85	TPA2025D1	Samples

(1) The marketing status values are defined as follows:

ACTIVE: Product device recommended for new designs.

LIFEBUY: TI has announced that the device will be discontinued, and a lifetime-buy period is in effect.

NRND: Not recommended for new designs. Device is in production to support existing customers, but TI does not recommend using this part in a new design.

PREVIEW: Device has been announced but is not in production. Samples may or may not be available.

OBSELETE: TI has discontinued the production of the device.

(2) Eco Plan - The planned eco-friendly classification: Pb-Free (RoHS), Pb-Free (RoHS Exempt), or Green (RoHS & no Sb/Br) - please check <http://www.ti.com/productcontent> for the latest availability information and additional product content details.

TBD: The Pb-Free/Green conversion plan has not been defined.

Pb-Free (RoHS): TI's terms "Lead-Free" or "Pb-Free" mean semiconductor products that are compatible with the current RoHS requirements for all 6 substances, including the requirement that lead not exceed 0.1% by weight in homogeneous materials. Where designed to be soldered at high temperatures, TI Pb-Free products are suitable for use in specified lead-free processes.

Pb-Free (RoHS Exempt): This component has a RoHS exemption for either 1) lead-based flip-chip solder bumps used between the die and package, or 2) lead-based die adhesive used between the die and leadframe. The component is otherwise considered Pb-Free (RoHS compatible) as defined above.

Green (RoHS & no Sb/Br): TI defines "Green" to mean Pb-Free (RoHS compatible), and free of Bromine (Br) and Antimony (Sb) based flame retardants (Br or Sb do not exceed 0.1% by weight in homogeneous material)

(3) MSL, Peak Temp. - The Moisture Sensitivity Level rating according to the JEDEC industry standard classifications, and peak solder temperature.

(4) There may be additional marking, which relates to the logo, the lot trace code information, or the environmental category on the device.

(5) Multiple Device Markings will be inside parentheses. Only one Device Marking contained in parentheses and separated by a "~" will appear on a device. If a line is indented then it is a continuation of the previous line and the two combined represent the entire Device Marking for that device.

(6) Lead/Ball Finish - Orderable Devices may have multiple material finish options. Finish options are separated by a vertical ruled line. Lead/Ball Finish values may wrap to two lines if the finish value exceeds the maximum column width.

Important Information and Disclaimer: The information provided on this page represents TI's knowledge and belief as of the date that it is provided. TI bases its knowledge and belief on information provided by third parties, and makes no representation or warranty as to the accuracy of such information. Efforts are underway to better integrate information from third parties. TI has taken and continues to take reasonable steps to provide representative and accurate information but may not have conducted destructive testing or chemical analysis on incoming materials and chemicals. TI and TI suppliers consider certain information to be proprietary, and thus CAS numbers and other limited information may not be available for release.

In no event shall TI's liability arising out of such information exceed the total purchase price of the TI part(s) at issue in this document sold by TI to Customer on an annual basis.

TAPE AND REEL INFORMATION



QUADRANT ASSIGNMENTS FOR PIN 1 ORIENTATION IN TAPE



*All dimensions are nominal

Device	Package Type	Package Drawing	Pins	SPQ	Reel Diameter (mm)	Reel Width W1 (mm)	A0 (mm)	B0 (mm)	K0 (mm)	P1 (mm)	W (mm)	Pin1 Quadrant
TPA2025D1YZGR	DSBGA	YZG	12	3000	180.0	8.4	1.63	2.08	0.69	4.0	8.0	Q1
TPA2025D1YZGT	DSBGA	YZG	12	250	180.0	8.4	1.63	2.08	0.69	4.0	8.0	Q1

TAPE AND REEL BOX DIMENSIONS

*All dimensions are nominal

Device	Package Type	Package Drawing	Pins	SPQ	Length (mm)	Width (mm)	Height (mm)
TPA2025D1YZGR	DSBGA	YZG	12	3000	182.0	182.0	20.0
TPA2025D1YZGT	DSBGA	YZG	12	250	182.0	182.0	20.0

YZG (R-XBGA-N12)

DIE-SIZE BALL GRID ARRAY

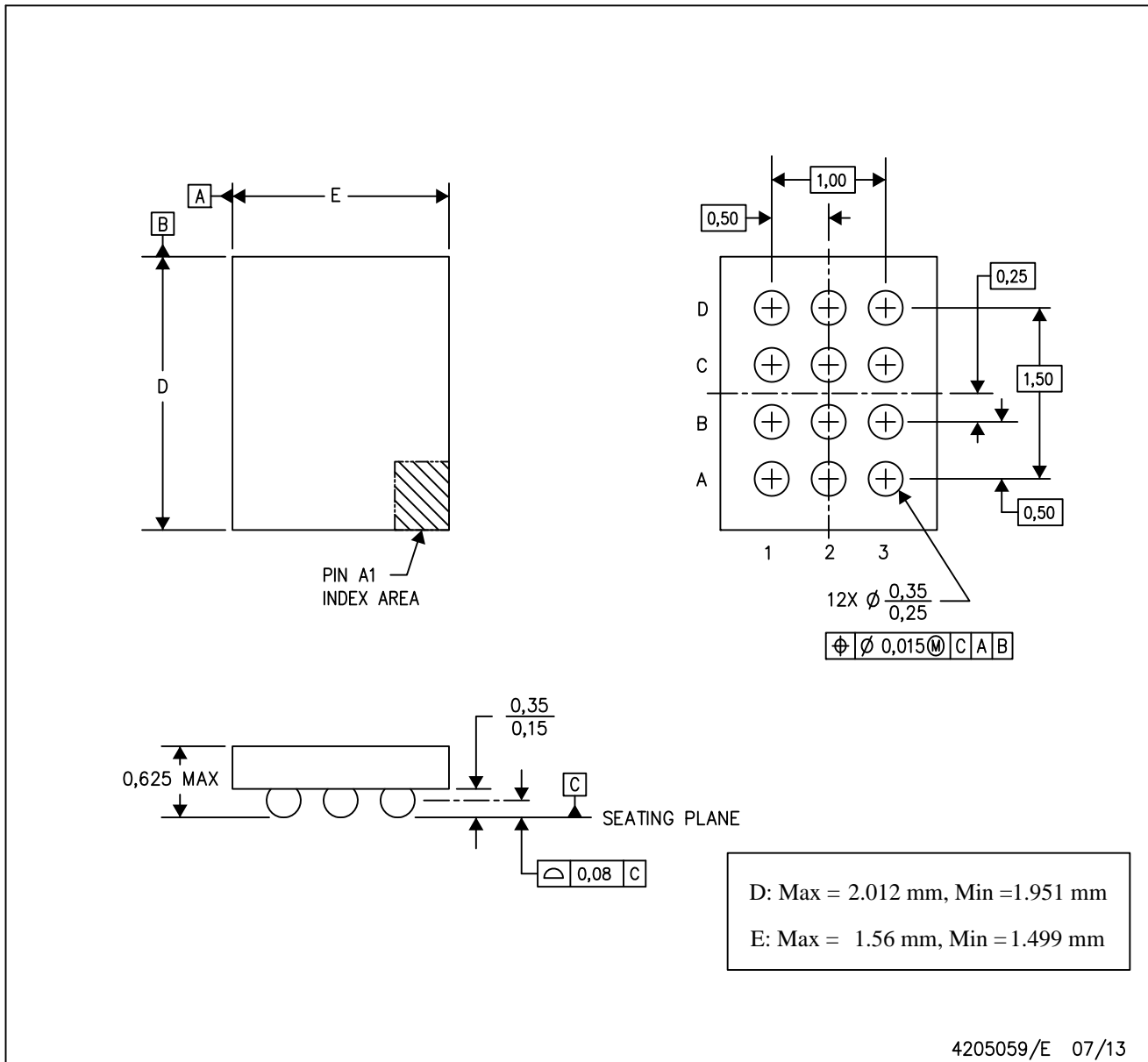

- NOTES: A. All linear dimensions are in millimeters. Dimensioning and tolerancing per ASME Y14.5M-1994.
B. This drawing is subject to change without notice.
C. NanoFree™ package configuration.

IMPORTANT NOTICE

Texas Instruments Incorporated (TI) reserves the right to make corrections, enhancements, improvements and other changes to its semiconductor products and services per JESD46, latest issue, and to discontinue any product or service per JESD48, latest issue. Buyers should obtain the latest relevant information before placing orders and should verify that such information is current and complete.

TI's published terms of sale for semiconductor products (<http://www.ti.com/sc/docs/stdterms.htm>) apply to the sale of packaged integrated circuit products that TI has qualified and released to market. Additional terms may apply to the use or sale of other types of TI products and services.

Reproduction of significant portions of TI information in TI data sheets is permissible only if reproduction is without alteration and is accompanied by all associated warranties, conditions, limitations, and notices. TI is not responsible or liable for such reproduced documentation. Information of third parties may be subject to additional restrictions. Resale of TI products or services with statements different from or beyond the parameters stated by TI for that product or service voids all express and any implied warranties for the associated TI product or service and is an unfair and deceptive business practice. TI is not responsible or liable for any such statements.

Buyers and others who are developing systems that incorporate TI products (collectively, "Designers") understand and agree that Designers remain responsible for using their independent analysis, evaluation and judgment in designing their applications and that Designers have full and exclusive responsibility to assure the safety of Designers' applications and compliance of their applications (and of all TI products used in or for Designers' applications) with all applicable regulations, laws and other applicable requirements. Designer represents that, with respect to their applications, Designer has all the necessary expertise to create and implement safeguards that (1) anticipate dangerous consequences of failures, (2) monitor failures and their consequences, and (3) lessen the likelihood of failures that might cause harm and take appropriate actions. Designer agrees that prior to using or distributing any applications that include TI products, Designer will thoroughly test such applications and the functionality of such TI products as used in such applications.

TI's provision of technical, application or other design advice, quality characterization, reliability data or other services or information, including, but not limited to, reference designs and materials relating to evaluation modules, (collectively, "TI Resources") are intended to assist designers who are developing applications that incorporate TI products; by downloading, accessing or using TI Resources in any way, Designer (individually or, if Designer is acting on behalf of a company, Designer's company) agrees to use any particular TI Resource solely for this purpose and subject to the terms of this Notice.

TI's provision of TI Resources does not expand or otherwise alter TI's applicable published warranties or warranty disclaimers for TI products, and no additional obligations or liabilities arise from TI providing such TI Resources. TI reserves the right to make corrections, enhancements, improvements and other changes to its TI Resources. TI has not conducted any testing other than that specifically described in the published documentation for a particular TI Resource.

Designer is authorized to use, copy and modify any individual TI Resource only in connection with the development of applications that include the TI product(s) identified in such TI Resource. NO OTHER LICENSE, EXPRESS OR IMPLIED, BY ESTOPPEL OR OTHERWISE TO ANY OTHER TI INTELLECTUAL PROPERTY RIGHT, AND NO LICENSE TO ANY TECHNOLOGY OR INTELLECTUAL PROPERTY RIGHT OF TI OR ANY THIRD PARTY IS GRANTED HEREIN, including but not limited to any patent right, copyright, mask work right, or other intellectual property right relating to any combination, machine, or process in which TI products or services are used. Information regarding or referencing third-party products or services does not constitute a license to use such products or services, or a warranty or endorsement thereof. Use of TI Resources may require a license from a third party under the patents or other intellectual property of the third party, or a license from TI under the patents or other intellectual property of TI.

TI RESOURCES ARE PROVIDED "AS IS" AND WITH ALL FAULTS. TI DISCLAIMS ALL OTHER WARRANTIES OR REPRESENTATIONS, EXPRESS OR IMPLIED, REGARDING RESOURCES OR USE THEREOF, INCLUDING BUT NOT LIMITED TO ACCURACY OR COMPLETENESS, TITLE, ANY EPIDEMIC FAILURE WARRANTY AND ANY IMPLIED WARRANTIES OF MERCHANTABILITY, FITNESS FOR A PARTICULAR PURPOSE, AND NON-INFRINGEMENT OF ANY THIRD PARTY INTELLECTUAL PROPERTY RIGHTS. TI SHALL NOT BE LIABLE FOR AND SHALL NOT DEFEND OR INDEMNIFY DESIGNER AGAINST ANY CLAIM, INCLUDING BUT NOT LIMITED TO ANY INFRINGEMENT CLAIM THAT RELATES TO OR IS BASED ON ANY COMBINATION OF PRODUCTS EVEN IF DESCRIBED IN TI RESOURCES OR OTHERWISE. IN NO EVENT SHALL TI BE LIABLE FOR ANY ACTUAL, DIRECT, SPECIAL, COLLATERAL, INDIRECT, PUNITIVE, INCIDENTAL, CONSEQUENTIAL OR EXEMPLARY DAMAGES IN CONNECTION WITH OR ARISING OUT OF TI RESOURCES OR USE THEREOF, AND REGARDLESS OF WHETHER TI HAS BEEN ADVISED OF THE POSSIBILITY OF SUCH DAMAGES.

Unless TI has explicitly designated an individual product as meeting the requirements of a particular industry standard (e.g., ISO/TS 16949 and ISO 26262), TI is not responsible for any failure to meet such industry standard requirements.

Where TI specifically promotes products as facilitating functional safety or as compliant with industry functional safety standards, such products are intended to help enable customers to design and create their own applications that meet applicable functional safety standards and requirements. Using products in an application does not by itself establish any safety features in the application. Designers must ensure compliance with safety-related requirements and standards applicable to their applications. Designer may not use any TI products in life-critical medical equipment unless authorized officers of the parties have executed a special contract specifically governing such use. Life-critical medical equipment is medical equipment where failure of such equipment would cause serious bodily injury or death (e.g., life support, pacemakers, defibrillators, heart pumps, neurostimulators, and implantables). Such equipment includes, without limitation, all medical devices identified by the U.S. Food and Drug Administration as Class III devices and equivalent classifications outside the U.S.

TI may expressly designate certain products as completing a particular qualification (e.g., Q100, Military Grade, or Enhanced Product). Designers agree that it has the necessary expertise to select the product with the appropriate qualification designation for their applications and that proper product selection is at Designers' own risk. Designers are solely responsible for compliance with all legal and regulatory requirements in connection with such selection.

Designer will fully indemnify TI and its representatives against any damages, costs, losses, and/or liabilities arising out of Designer's non-compliance with the terms and provisions of this Notice.