

# TPD12S015A HDMI Companion Chip With Step-Up DC-DC, I<sup>2</sup>C Level Shifter, and High-Speed ESD Clamps

## 1 Features

- Conforms to HDMI Compliance Tests Without Any External Components
- Supports HDMI 1.3 and HDMI 1.4 Data Rate
- Match Class D and Class C Pin Mapping
- Excellent Matching Capacitance (0.05 pF) in Each Differential Signal Pair
- Internal Boost Converter to Generate 5 V From a 2.3-V to 5.5-V Battery Voltage
- Auto-Direction Sensing Level Shifting in the CEC, SDA, and SCL Paths
- IEC 61000-4-2 (Level 4) System Level ESD Compliance
- Improved Drop-In Replacement for the Industry Popular TPD12S015A
- Industrial Temperature Range: –40°C to 85°C

## 2 Applications

- Smart Phones
- eBooks
- Tablet PCs
- Digital Camcorders
- Portable Game Consoles
- Digital Still Cameras

### SCL\_B or SDA\_B Buffers of TPD12S015A Driving Long HDMI Cable (750-pF Load)

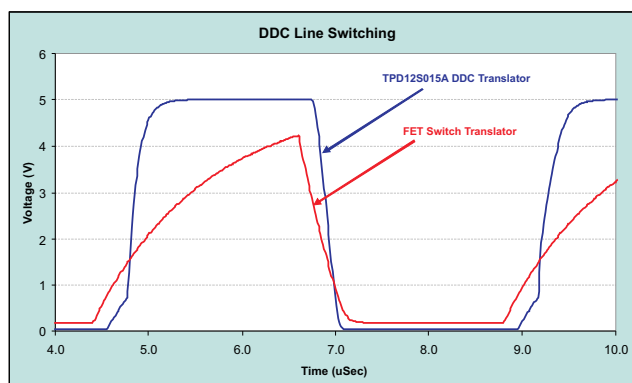

## 3 Description

The TPD12S015A device is an integrated HDMI companion chip solution. This device offers 8 low capacitance ESD clamps allowing HDMI 1.3/1.4 data rates. The 0.4-mm pitch DSBGA package pin mapping matches the HDMI Type D or Type C connectors. The integrated ESD clamps in monolithic silicon technology provide good matching between each differential signal pair. This provides an advantage over discrete ESD clamp solutions where variations between ESD clamps degrade the differential signal quality.

The TPD12S015A provides a regulated 5-V output (5VOUT) for sourcing the HDMI power line. The 5VOUT pin supplies minimum 55 mA to the HDMI receiver while meeting the HDMI 5VOUT specifications. The 5VOUT and the hot plug detect (HPD) circuitry are independent of the LS\_OE control signal; they are controlled by the CT\_CP\_HPDP pin. This independent control enables the detection scheme (5VOUT + HPD) to be active before enabling the HDMI link. The HPD\_B port has a glitch filter to avoid false detection due to the bouncing while inserting the HDMI plug.

There are three noninverting bidirectional translation circuits for the SDA, SCL, and CEC lines; they are controlled by the LS\_OE control signal. Each have a common power rail (VCCA) on the A side from 1.1 V to 3.6 V. On the B side, the SCL\_B and SDA\_B each have an internal 1.75-kΩ pullup connected to the regulated 5-V rail (5VOUT). The SCL and SDA pins meet the I<sup>2</sup>C specifications, and drive at least 750-pF loads which exceeds the HDMI cable specification. An LDO generates a 3.3-V internal rail for the CEC line operation when LS\_OE = H & CT\_CP\_HPDP = H. The CEC\_B pin has a 26-kΩ pullup to this internal 3.3-V rail.

The TPD12S015A provides IEC61000-4-2 (Level 4) ESD protection. This device is offered in a space-saving 1.56-mm × 2.76-mm DSBGA package.

### Device Information<sup>(1)</sup>

PART NUMBER	PACKAGE	BODY SIZE (NOM)
TPD12S015A	DSBGA (28)	1.56 mm × 2.76 mm

(1) For all available packages, see the orderable addendum at the end of the data sheet.



## Table of Contents

<b>1 Features</b> .....	<b>1</b>	CEC Line (x_A & x_B ports); V <sub>CCA</sub> = 1.8 V .....	<b>11</b>
<b>2 Applications</b> .....	<b>1</b>	6.23 Switching Characteristics: Voltage Level Shifter: HPD Line (x_A & x_B ports); V <sub>CCA</sub> = 1.8 V .....	<b>11</b>
<b>3 Description</b> .....	<b>1</b>	6.24 Switching Characteristics: Voltage Level Shifter: SCL, SDA Lines (x_A & x_B ports); V <sub>CCA</sub> = 2.5 V... ..	<b>12</b>
<b>4 Revision History</b> .....	<b>2</b>	6.25 Switching Characteristics: Voltage Level Shifter: CEC Line (x_A & x_B ports); V <sub>CCA</sub> = 2.5 V .....	<b>12</b>
<b>5 Pin Configuration and Functions</b> .....	<b>3</b>	6.26 Switching Characteristics: Voltage Level Shifter: HPD Line (x_A & x_B ports); V <sub>CCA</sub> = 2.5 V .....	<b>12</b>
<b>6 Specifications</b> .....	<b>5</b>	6.27 Switching Characteristics: Voltage Level Shifter: SCL, SDA Lines (x_A & x_B ports); V <sub>CCA</sub> = 3.3 V... ..	<b>12</b>
6.1 Absolute Maximum Ratings .....	<b>5</b>	6.28 Switching Characteristics: Voltage Level Shifter: CEC Line (x_A & x_B ports); V <sub>CCA</sub> = 3.3 V .....	<b>13</b>
6.2 ESD Ratings .....	<b>5</b>	6.29 Switching Characteristics: Voltage Level Shifter: HPD Line (x_A & x_B ports); V <sub>CCA</sub> = 3.3 V .....	<b>13</b>
6.3 Recommended Operating Conditions .....	<b>5</b>	6.30 Typical Characteristics .....	<b>14</b>
6.4 Thermal Information .....	<b>6</b>	<b>7 Parameter Measurement Information</b> .....	<b>17</b>
6.5 Electrical Characteristics: I <sub>CC</sub> .....	<b>6</b>	<b>8 Detailed Description</b> .....	<b>18</b>
6.6 Electrical Characteristics: High-Speed ESD Lines: Dx, CLK .....	<b>6</b>	8.1 Overview .....	<b>18</b>
6.7 Electrical Characteristics: DC-DC Converter .....	<b>7</b>	8.2 Functional Block Diagram .....	<b>18</b>
6.8 Electrical Characteristics: Passive Components .....	<b>7</b>	8.3 Feature Description .....	<b>19</b>
6.9 Electrical Characteristics: Voltage Level Shifter: SCL, SDA Lines (x_A/x_B Ports) .....	<b>8</b>	8.4 Device Functional Modes .....	<b>21</b>
6.10 Electrical Characteristics: Voltage Level Shifter: CEC Lines (x_A/x_B Ports) .....	<b>8</b>	<b>9 Application and Implementation</b> .....	<b>22</b>
6.11 Electrical Characteristics: Voltage Level Shifter: HPD Line (x_A/x_B Ports) .....	<b>9</b>	9.1 Application Information .....	<b>22</b>
6.12 Electrical Characteristics: LS_OE, CT_CP_HPDP... ..	<b>9</b>	9.2 Typical Applications .....	<b>22</b>
6.13 Electrical Characteristics: I/O Capacitance .....	<b>9</b>	<b>10 Power Supply Recommendations</b> .....	<b>27</b>
6.14 Switching Characteristics .....	<b>9</b>	<b>11 Layout</b> .....	<b>27</b>
6.15 Switching Characteristics: Voltage Level Shifter: SCL, SDA Lines (x_A & x_B ports); V <sub>CCA</sub> = 1.2 V... ..	<b>9</b>	11.1 Layout Guidelines .....	<b>27</b>
6.16 Switching Characteristics: Voltage Level Shifter: CEC Line (x_A & x_B ports); V <sub>CCA</sub> = 1.2 V .....	<b>10</b>	11.2 Layout Example .....	<b>27</b>
6.17 Switching Characteristics: Voltage Level Shifter: HPD Line (x_A & x_B ports); V <sub>CCA</sub> = 1.2 V .....	<b>10</b>	<b>12 Device and Documentation Support</b> .....	<b>28</b>
6.18 Switching Characteristics: Voltage Level Shifter: SCL, SDA Lines (x_A & x_B ports); V <sub>CCA</sub> = 1.5 V... ..	<b>10</b>	12.1 Documentation Support .....	<b>28</b>
6.19 Switching Characteristics: Voltage Level Shifter: CEC Line (x_A & x_B ports); V <sub>CCA</sub> = 1.5 V .....	<b>10</b>	12.2 Receiving Notification of Documentation Updates .....	<b>28</b>
6.20 Switching Characteristics: Voltage Level Shifter: HPD Line (x_A & x_B ports); V <sub>CCA</sub> = 1.5 V .....	<b>11</b>	12.3 Community Resource .....	<b>28</b>
6.21 Switching Characteristics: Voltage Level Shifter: SCL, SDA Lines (x_A & x_B ports); V <sub>CCA</sub> = 1.8 V... ..	<b>11</b>	12.4 Trademarks .....	<b>28</b>
6.22 Switching Characteristics: Voltage Level Shifter:		12.5 Electrostatic Discharge Caution .....	<b>28</b>
		12.6 Glossary .....	<b>28</b>
		<b>13 Mechanical, Packaging, and Orderable Information</b> .....	<b>28</b>

## 4 Revision History

NOTE: Page numbers for previous revisions may differ from page numbers in the current version.

### Changes from Revision C (March 2013) to Revision D Page

- Added ESD Ratings table, Thermal Information table, Feature Description section, Device Functional Modes, Application and Implementation section, Power Supply Recommendations section, Layout section, Device and Documentation Support section, and Mechanical, Packaging, and Orderable Information section..... **1**

### Changes from Revision B (April 2012) to Revision C Page

- Added Power Derating Curve..... **14**
- Changed Board Layout section .....

## 5 Pin Configuration and Functions

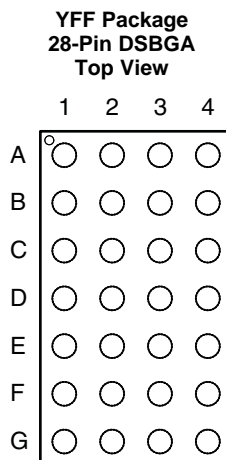

For package dimensions, see [Mechanical, Packaging, and Orderable Information](#)

### Pin Functions

PIN		TYPE	DESCRIPTION
NAME	NO.		
5VOUT	F1	Power Out	DC-DC output. The 5-V power pin can supply 55 mA of regulated current to the HDMI receiver. Separate DC-DC converter control pin CT_CP_HPDP disables the DC-DC converter when operating at low-power mode.
CEC_A	B2	I/O	System-side CEC bus I/O. This pin is bidirectional and referenced to $V_{CCA}$ .
CEC_B	D3	I/O	HDMI-side CEC bus I/O. This pin is bidirectional and referenced to the 3.3-V internal supply.
CLK-, CLK+	G4, F4	ESD	High-speed ESD clamp: provides ESD protection to the high-speed HDMI differential data lines
CT_CP_HPDP	D1	Control	DC-DC Enable. Enables the DC-DC converter and HPD circuitry when CT_CP_HPDP = H. The CT_CP_HPDP is referenced to $V_{CCA}$ .
D0-, D0+, D1-, D1+, D2-, D2+	E4, D4, C4, B4, A4, A3	ESD	High-speed ESD clamp: provides ESD protection to the high-speed HDMI differential data lines
FB	E1	I	Feedback input. This pin is a feedback control pin for the DC-DC converter. It must be connected to 5VOUT.
GND	B3, C3, D2, E2	Ground	Device ground
HPD_A	C2	O	System-side output for the hot plug detect. This pin is unidirectional and is referenced to $V_{CCA}$ .
HPD_B	G3	I	HDMI-side input for the hot plug detect. This pin is unidirectional and is referenced to 5VOUT.
LS_OE	A1	Control	Level shifter enable. This pin is referenced to $V_{CCA}$ . Enables SCL, SDA, CEC level shifters, and LDO when LS_OE = H.
P <sub>GND</sub>	G1	Analog Ground	DC-DC converter ground. This pin must be tied externally to the system GND plane. See <a href="#">Layout Guidelines</a> .
SCL_A	B1	I/O	System-side input and output for I <sup>2</sup> C bus. This pin is bidirectional and referenced to $V_{CCA}$ .
SCL_B	E3	I/O	HDMI-side input and output for I <sup>2</sup> C bus. This pin is bidirectional and referenced to 5VOUT.
SDA_A	C1	I/O	System-side input and output for I <sup>2</sup> C bus. This pin is bidirectional and referenced to $V_{CCA}$ .
SDA_B	F3	I/O	HDMI-side input and output for I <sup>2</sup> C bus. This pin is bidirectional and referenced to 5VOUT.
SW	F2	I	Switch input. This pin is the inductor input for the DC-DC converter.
V <sub>BAT</sub>	G2	Supply	Battery supply. This voltage is typically 2.3 V to 5.5 V
V <sub>CCA</sub>	A2	Supply	System-side supply. this voltage is typically 1.2 V to 3.3 V from the core microcontroller.

**Table 1. YFF Package Pin Mapping**

	1	2	3	4
<b>A</b>	LS_OE	V <sub>CCA</sub>	D2+	D2–
<b>B</b>	SCL_A	CEC_A	GND	D1+
<b>C</b>	SDA_A	HPD_A	GND	D1–
<b>D</b>	CT_CP_HPDP	GND	CEC_B	D0+
<b>E</b>	FB	GND	SCL_B	D0–
<b>F</b>	5VOUT	SW	SDA_B	CLK+
<b>G</b>	P <sub>GND</sub>	V <sub>BAT</sub>	HPD_B	CLK–

## 6 Specifications

### 6.1 Absolute Maximum Ratings

over operating free-air temperature range (unless otherwise noted)<sup>(1)</sup>

		MIN	MAX	UNIT	
V <sub>CCA</sub>	Supply voltage		4	V	
V <sub>BAT</sub>	Supply voltage	-0.3	6		
V <sub>I</sub>	Input voltage	HPD_B, Dx, CLKx	-0.3	6	V
		CT_CP_HPDP, LS_OE	-0.3	4	
V <sub>O</sub>	Voltage range applied to any output in the high-impedance or power-off state <sup>(2)</sup>	SCL_A, SDA_A, CEC_A, HPD_A	-0.3	4	V
		SCL_B, SDA_B, CEC_B	-0.3	6	
	Voltage range applied to any output in the high or low state <sup>(3)</sup>	SCL_A, SDA_A, CEC_A, HPD_A	-0.3	V <sub>CCA</sub> + 0.3	
		SCL_B, SDA_B, CEC_B	-0.3	6	
I <sub>IK</sub>	Input clamp current	V <sub>I</sub> < 0	-50	mA	
I <sub>OK</sub>	Output clamp current	V <sub>O</sub> < 0	-50	mA	
I <sub>OUTMAX</sub>	Continuous current through 5VOUT or GND		±100	mA	
T <sub>stg</sub>	Storage temperature		-65	150	°C

- (1) Stresses beyond those listed under *Absolute Maximum Ratings* may cause permanent damage to the device. These are stress ratings only, which do not imply functional operation of the device at these or any other conditions beyond those indicated under *Recommended Operating Conditions*. Exposure to absolute-maximum-rated conditions for extended periods may affect device reliability.
- (2) The input and output voltage ratings may be exceeded if the input and output clamp-current ratings are observed.
- (3) The package thermal impedance is calculated in accordance with JESD 51-7.

### 6.2 ESD Ratings

			VALUE	UNIT
V <sub>(ESD)</sub>	Electrostatic discharge	Human-body model (HBM), per ANSI/ESDA/JEDEC JS-001 <sup>(1)</sup>	±2500	V
			±15000	
		Charged-device model (CDM), per JEDEC specification JESD22-C101 <sup>(2)</sup>	±1000	
		IEC 61000-4-2 contact discharge	±8000	

- (1) JEDEC document JEP155 states that 500-V HBM allows safe manufacturing with a standard ESD control process.
- (2) JEDEC document JEP157 states that 250-V CDM allows safe manufacturing with a standard ESD control process.

### 6.3 Recommended Operating Conditions

over recommended operating free-air temperature range (unless otherwise noted)

		SUPPLY	MIN	NOM	MAX	UNIT
V <sub>CCA</sub>	Supply voltage		1.1		3.6	V
V <sub>BAT</sub>	Supply voltage		2.3		5.5	V
V <sub>IH</sub>	High-level input voltage	SCL_A, SDA_A, CEC_A	V <sub>CCA</sub> = 1.1 V to 3.6 V	0.7 × V <sub>CCA</sub>	V <sub>CCA</sub>	V
		CT_CP_HPDP, LS_OE		1	3.6	
		SCL_B, SDA_B	5VOUT = 5 V	0.7 × 5VOUT	5VOUT	
		CEC_B		0.7 × 3.3 (internal) <sup>(1)</sup>	3.3 (internal) <sup>(1)</sup>	
		HPD_B		2	5VOUT	

- (1) '3.3V (internal)' is an internally generated voltage node for the CEC\_B output buffer supply reference. An LDO generates this 3.3 V from 5VOUT when LS\_OE = H & CT\_CP\_HPDP = H.

## Recommended Operating Conditions (continued)

over recommended operating free-air temperature range (unless otherwise noted)

		SUPPLY	MIN	NOM	MAX	UNIT
V <sub>IL</sub>	Low-level input voltage	SCL_A, SDA_A, CEC_A	V <sub>CCA</sub> = 1.1 V to 3.6 V	0	0.082 × V <sub>CCA</sub>	V
		CT_CP_HPDP, LS_OE		0	0.4	
		SCL_B, SDA_B	5VOUT = 5 V	0	0.3 × 5VOUT	
		CEC_B		0	0.3 × 3.3V (internal) <sup>(1)</sup>	
		HPD_B		0	0.8	
V <sub>ILC</sub>	Low-level input voltage (contention)	SCL_A, SDA_A, CEC_A	V <sub>CCA</sub> = 1.1 V to 3.6 V	0	0.065 × V <sub>CCA</sub>	V
V <sub>OL</sub> – V <sub>ILC</sub>	Delta between V <sub>OL</sub> and V <sub>ILC</sub>	SCL_A, SDA_A, CEC_A	V <sub>CCA</sub> = 1.1 V to 3.6 V		0.1 × V <sub>CCA</sub>	V
T <sub>A</sub>	Operating free-air temperature			–40	85	°C

## 6.4 Thermal Information

THERMAL METRIC <sup>(1)</sup>		TPD12S015A	UNIT
		YFF (DSBGA)	
		28 PINS	
R <sub>θJA</sub>	Junction-to-ambient thermal resistance	63	°C/W
R <sub>θJC(top)</sub>	Junction-to-case (top) thermal resistance	0.4	°C/W
R <sub>θJB</sub>	Junction-to-board thermal resistance	9.2	°C/W
ψ <sub>JT</sub>	Junction-to-top characterization parameter	1.6	°C/W
ψ <sub>JB</sub>	Junction-to-board characterization parameter	9.1	°C/W
R <sub>θJC(bot)</sub>	Junction-to-case (bottom) thermal resistance	N/A	°C/W

(1) For more information about traditional and new thermal metrics, see the [Semiconductor and IC Package Thermal Metrics](#) application report.

## 6.5 Electrical Characteristics: I<sub>CC</sub>

PARAMETER		PIN	TEST CONDITIONS	MIN	TYP	MAX	UNIT
I <sub>CCA</sub>	Standby	V <sub>CCA</sub>	I/O = High			2	μA
	Active					15	
I <sub>CCB</sub>	Standby	V <sub>BAT</sub>	CT_CP_HPDP=L, LS_OE=L, HPD_B=L		2		μA
	DC-DC and HPD active		CT_CP_HPDP=H, LS_OE=L, HPD_B=L		30	50	
	DC-DC, HPD, DDC, CEC active		CT_CP_HPDP=H LS_OE=H, HPD_B=L, I/O =H		225	300	

## 6.6 Electrical Characteristics: High-Speed ESD Lines: Dx, CLK

PARAMETER		TEST CONDITIONS		MIN	TYP	MAX	UNIT
I <sub>OFF</sub>	Current from IO port to supply pins	V <sub>CC</sub> = 0 V, V <sub>IO</sub> = 3.3 V			0.01	0.5	μA
V <sub>DL</sub>	Diode forward voltage	I <sub>D</sub> = 8 mA,	Lower clamp diode		0.85	1	V
R <sub>DYN</sub>	Dynamic resistance	I = 1 A	D, CLK		1		Ω
C <sub>IO</sub>	IO capacitance	V <sub>CC</sub> = 5 V V <sub>IO</sub> = 2.5 V	D, CLK		1.3		pF
V <sub>BR</sub>	Break-down voltage	I <sub>IO</sub> = 1 mA		9		12	V

## 6.7 Electrical Characteristics: DC-DC Converter

PARAMETER		TEST CONDITIONS	MIN	TYP	MAX	UNIT
V <sub>BAT</sub>	Input voltage range		2.3		5.5	V
5V <sub>OUT</sub>	Total DC output voltage	Includes voltage references, DC load / line regulations, process and temperature	4.9	5	5.13	V
TOVA	Total output voltage accuracy	Includes voltage references, DC load / line regulations, transient load / line regulations, ripple, process, and temperature	4.8	5	5.3	V
V <sub>O_Ripple</sub>	Output voltage ripple, loaded	I <sub>O</sub> = 65 mA			20	mVp-p
F <sub>clk</sub>	Internal operating frequency	V <sub>BAT</sub> = 2.3 V to 5.5 V		3.5		MHz
t <sub>start</sub>	Start-up time	From CT_CP_HPDP input to 5-V power output 90% point			300	μs
I <sub>O</sub>	Output current	V <sub>BAT</sub> = 2.3 V to 5.5 V	55			mA
	Reverse leakage current V <sub>O</sub>	CT_CP_HPDP = L, V <sub>O</sub> = 5.5 V			2.5	μA
	Leakage current from battery to V <sub>O</sub>	CT_CP_HPDP = L			5	μA
V <sub>BATUVT</sub>	Undervoltage lockout threshold	Falling		2		V
		Rising		2.1		V
V <sub>BATOVT</sub>	Overvoltage lockout threshold	Falling		5.9		V
		Rising		6		V
	Line transient response	V <sub>BAT</sub> = 3.6 V, a pulse of 217-Hz 600 mVp-p square wave, I <sub>O</sub> = 20/65 mA		±25	±50	mVpk
	Load transient response	V <sub>BAT</sub> = 3.6 V, I <sub>O</sub> = 5 to 65 mA, pulse of 10 μs, t <sub>r</sub> = t <sub>f</sub> = 0.1 μs		50		mVpk
I <sub>DD (idle)</sub>	Power supply current from V <sub>BAT</sub> to DC-DC, enabled, unloaded	I <sub>O</sub> = 0 mA		30	50	μA
I <sub>DD (disabled)</sub>	Power supply current from V <sub>BAT</sub> , DC-DC Disabled, Unloaded	V <sub>BAT</sub> = 2.3 V to 5.5 V, I <sub>O</sub> = 0 mA, CT_CP_HPDP Low			2	μA
I <sub>DD(system off)</sub>	Power supply current from V <sub>BAT</sub> , V <sub>CCA</sub> = 0 V	V <sub>CCA</sub> = 0 V			5	μA
I <sub>inrush (startup)</sub>	Inrush current, average over T <sub>startup</sub> time	V <sub>BAT</sub> = 2.3 V to 5.5 V, I <sub>O</sub> = 65 mA		100		mA
T <sub>SD</sub>	Thermal shutdown	Increasing junction temperature		140		°C
ΔT <sub>SD</sub>	Thermal shutdown hysteresis	Decreasing junction temperature		20		°C
I <sub>SC</sub>	Short-circuit current limit from output	5-Ω short to GND			500	mA

## 6.8 Electrical Characteristics: Passive Components

PARAMETER		TYP	UNIT
L <sub>IN</sub>	External inductor, 0805 footprint	1	μH
C <sub>IN</sub>	Input capacitor, 0603 footprint	4.7	μF
C <sub>OUT</sub>	Output capacitor, 0603 footprint	4.7	μF
C <sub>VCCA</sub>	Input capacitor, 0402 footprint	0.1	μF

### 6.9 Electrical Characteristics: Voltage Level Shifter: SCL, SDA Lines (x\_A/x\_B Ports)

 $T_A = -40^{\circ}\text{C}$  to  $85^{\circ}\text{C}$  unless otherwise specified

PARAMETER		TEST CONDITIONS	$V_{CCA}$	MIN	TYP	MAX	UNIT
$V_{OHA}$		$I_{OH} = -10\ \mu\text{A}$ , $V_I = V_{IH}$	1.1 V to 3.6 V	$V_{CCA} \times 0.8$			V
$V_{OLA}$		$I_{OL} = 10\ \mu\text{A}$ , $V_I = V_{IL}$	1.1 V to 3.6 V		$V_{CCA} \times 0.17$		V
$V_{OHB}$		$I_{OH} = -10\ \mu\text{A}$ , $V_I = V_{IH}$		5VOUT $\times$ 0.9			V
$V_{OLB}$		$I_{OL} = 3\ \text{mA}$ , $V_I = V_{IL}$				0.4	V
$\Delta V_T$ hysteresis	SDX_A ( $V_{T+} - V_{T-}$ )		1.1 V to 3.6 V		40		mV
	SDX_B ( $V_{T+} - V_{T-}$ )		1.1 V to 3.6 V		400		
$R_{PU}$	(Internal pullup)	SCL_A, SDA_A, Internal pullup connected to $V_{CCA}$ rail			10		k $\Omega$
		SCL_B, SDA_B, Internal pullup connected to 5-V rail			1.75		
$I_{PULLUPAC}$	Transient boosted pullup current (rise time accelerator)	SCL_B, SDA_B, Internal pullup connected to 5-V rail			15		mA
$I_{OFF}$	A port	$V_{CCA} = 0\ \text{V}$ , $V_I$ or $V_O = 0$ to 3.6 V	0 V			$\pm 5$	$\mu\text{A}$
	B port	5VOUT = 0 V, $V_I$ or $V_O = 0$ to 5.5 V	0 V to 3.6 V			$\pm 5$	
$I_{OZ}$	B port	$V_O = V_{CCO}$ or GND	1.1 V to 3.6 V			$\pm 5$	$\mu\text{A}$
	A port	$V_I = V_{CCI}$ or GND	1.1 V to 3.6 V			$\pm 5$	

### 6.10 Electrical Characteristics: Voltage Level Shifter: CEC Lines (x\_A/x\_B Ports)

 $T_A = -40^{\circ}\text{C}$  to  $85^{\circ}\text{C}$  unless otherwise specified

PARAMETER		TEST CONDITIONS	$V_{CCA}$	MIN	TYP	MAX	UNIT
$V_{OHA}$		$I_{OH} = -10\ \mu\text{A}$ , $V_I = V_{IH}$	1.1 V to 3.6 V	$V_{CCA} \times 0.8$			V
$V_{OLA}$		$I_{OL} = 10\ \mu\text{A}$ , $V_I = V_{IL}$	1.1 V to 3.6 V		$V_{CCA} \times 0.17$		V
$V_{OHB}$		$I_{OH} = -10\ \mu\text{A}$ , $V_I = V_{IH}$		3.3V (internal) $\times$ 0.9 <sup>(1)</sup>			V
$V_{OLB}$		$I_{OL} = 3\ \text{mA}$ , $V_I = V_{IL}$				0.4	V
$\Delta V_T$ hysteresis	CEC_A ( $V_{T+} - V_{T-}$ )		1.1 V to 3.6 V		40		mV
	CEC_B ( $V_{T+} - V_{T-}$ )		1.1 V to 3.6 V		300		
$R_{PU}$	(Internal pullup)	CEC_A Internal pullup connected to $V_{CCA}$ rail			10		k $\Omega$
		CEC_B Internal pullup connected to internal 3.3-V rail			26		
$I_{OFF}$	A port	$V_{CCA} = 0\ \text{V}$ , $V_I$ or $V_O = 0$ to 3.6 V	0 V			$\pm 5$	$\mu\text{A}$
	B port	5VOUT = 0 V, $V_I$ or $V_O = 0$ to 5.5 V	0 V to 3.6 V			$\pm 1.8$	
$I_{OZ}$	B port	$V_O = V_{CCO}$ or GND	1.1 V to 3.6 V			$\pm 5$	$\mu\text{A}$
	A port	$V_I = V_{CCI}$ or GND	1.1 V to 3.6 V			$\pm 5$	

(1) 3.3 V (internal) is an internally generated voltage node for the CEC\_B output buffer supply reference. An LDO generates this 3.3 V from 5VOUT when LS\_OE = H & CT\_CP\_HPD = H



### 6.11 Electrical Characteristics: Voltage Level Shifter: HPD Line (x\_A/x\_B Ports)

 $T_A = -40^{\circ}\text{C}$  to  $85^{\circ}\text{C}$  unless otherwise specified

PARAMETER		TEST CONDITIONS	$V_{CCA}$	MIN	TYP	MAX	UNIT
$V_{OHA}$		$I_{OH} = -3\text{ mA}$ , $V_I = V_{IH}$	1.1 V to 3.6 V	$V_{CCA} \times 0.7$			V
$V_{OLA}$		$I_{OL} = 3\text{ mA}$ , $V_I = V_{IL}$	1.1 V to 3.6 V			0.4	V
$\Delta V_T$ hysteresis	HPD_B ( $V_{T+} - V_{T-}$ )		1.1 V to 3.6 V		200		mV
$R_{PD}$	(Internal pulldown)	HPD_B, Internal pulldown connected to GND			11		$k\Omega$
$I_{OZ}$	A port	$V_I = V_{CCI}$ or GND	3.6 V			$\pm 5$	$\mu\text{A}$

### 6.12 Electrical Characteristics: LS\_OE, CT\_CP\_HPDP

 $T_A = -40^{\circ}\text{C}$  to  $85^{\circ}\text{C}$  unless otherwise specified

PARAMETER	TEST CONDITIONS	$V_{CCA}$	MIN	TYP	MAX	UNIT
$I_I$	$V_I = V_{CCA}$ or GND	1.1 V to 3.6 V			$\pm 12$	$\mu\text{A}$

### 6.13 Electrical Characteristics: I/O Capacitance

 $T_A = -40^{\circ}\text{C}$  to  $85^{\circ}\text{C}$  unless otherwise specified

PARAMETER		TEST CONDITIONS	$V_{CCA}$	MIN	TYP	MAX	UNIT
$C_I$	Control inputs	$V_I = 1.89\text{ V}$ or GND, AC input = 30 mV(p-p); $f = 10\text{ MHz}$	1.1 V to 3.6 V		7.1		pF
$C_{IO}$	A port	$V_O = 1.89\text{ V}$ or GND, AC input = 30 mV(p-p); $f = 10\text{ MHz}$ , CT_CP_HPDP = H, LS_OE = L	1.1 V to 3.6 V		8.3		pF
	B port	$V_O = 5\text{ V}$ or GND, AC input = 30 mV(p-p); $f = 10\text{ MHz}$ , CT_CP_HPDP = H, LS_OE = L	3.3 V		15		pF
$C_{IO}$	SCL_B, SDA_B	$V_{BAT} = 0\text{ V}$ , $V_{bias} = 2.5\text{ V}$ ; AC input = 3.5 V(p-p); $f = 100\text{ kHz}$	0 V		20		pF
	CEC_B	$V_{BAT} = 0\text{ V}$ , $V_{bias} = 1.65\text{ V}$ ; AC input = 2.5 V(p-p); $f = 100\text{ kHz}$	0 V		20		pF
		$V_{BAT} = 3.3\text{ V}$ , $V_{bias} = 1.65\text{ V}$ ; AC input = 2.5 V(p-p); $f = 100\text{ kHz}$ , CT_CP_HPDP = H, LS_OE = L	3.3 V		20		pF

### 6.14 Switching Characteristics

PARAMETER		TEST CONDITIONS	MIN	TYP	MAX	UNIT
$C_L$	Bus load capacitance (B side)				750	pF
	Bus load capacitance (A side)				15	

### 6.15 Switching Characteristics: Voltage Level Shifter: SCL, SDA Lines (x\_A & x\_B ports); $V_{CCA} = 1.2\text{ V}$

 $V_{CCA} = 1.2\text{ V}$ 

PARAMETER		PINS	TEST CONDITIONS	MIN	TYP	MAX	UNIT
$t_{PHL}$	Propagation delay	A to B	DDC Channels Enabled		344		ns
		B to A			355		
$t_{PLH}$	Propagation delay	A to B	DDC Channels Enabled		452		ns
		B to A			178		
$t_f$	A port fall time	A Port	DDC Channels Enabled		138		ns
	B port fall time	B Port			83		
$t_r$	A port rise time	A Port	DDC Channels Enabled		194		ns
	B port rise time	B Port			92		
$f_{MAX}$	Maximum switching frequency		DDC Channels Enabled	400			kHz

**TPD12S015A**

SLLSE74D – JUNE 2011 – REVISED JULY 2016

[www.ti.com](http://www.ti.com)
**6.16 Switching Characteristics: Voltage Level Shifter: CEC Line (x\_A & x\_B ports); V<sub>CCA</sub> = 1.2 V**

 V<sub>CCA</sub> = 1.2 V

PARAMETER		PINS	TEST CONDITIONS	MIN	TYP	MAX	UNIT
t <sub>PLH</sub>	Propagation delay	A to B	CEC Channels Enabled		445		ns
		B to A			337		
t <sub>PLH</sub>		A to B			13		μs
		B to A			0.266		
t <sub>f</sub>	A port fall time	A Port	CEC Channels Enabled		140		ns
	B port fall time	B Port			96		
t <sub>r</sub>	A port rise time	A Port	CEC Channels Enabled		202		ns
	B port rise time	B Port			15		

**6.17 Switching Characteristics: Voltage Level Shifter: HPD Line (x\_A & x\_B ports); V<sub>CCA</sub> = 1.2 V**

 V<sub>CCA</sub> = 1.2 V

PARAMETER		PINS	TEST CONDITIONS	MIN	TYP	MAX	UNIT
t <sub>PLH</sub>	Propagation delay	B to A	CEC Channels Enabled		10		μs
t <sub>PLH</sub>		B to A			9		
t <sub>f</sub>	A port fall time	A Port	CEC Channels Enabled		0.67		ns
t <sub>r</sub>	A port rise time	A Port	CEC Channels Enabled		0.74		ns

**6.18 Switching Characteristics: Voltage Level Shifter: SCL, SDA Lines (x\_A & x\_B ports); V<sub>CCA</sub> = 1.5 V**

 V<sub>CCA</sub> = 1.5 V

PARAMETER		PINS	TEST CONDITIONS	MIN	TYP	MAX	UNIT
t <sub>PLH</sub>	Propagation delay	A to B	DDC Channels Enabled		335		ns
		B to A			265		
t <sub>PLH</sub>		A to B			438		
		B to A			169		
t <sub>f</sub>	A port fall time	A Port	DDC Channels Enabled		110		ns
	B port fall time	B Port			83		
t <sub>r</sub>	A port rise time	A Port	DDC Channels Enabled		190		ns
	B port rise time	B Port			92		
f <sub>MAX</sub>	Maximum switching frequency		DDC Channels Enabled	400			kHz

**6.19 Switching Characteristics: Voltage Level Shifter: CEC Line (x\_A & x\_B ports); V<sub>CCA</sub> = 1.5 V**

 V<sub>CCA</sub> = 1.5 V

PARAMETER		PINS	TEST CONDITIONS	MIN	TYP	MAX	UNIT
t <sub>PLH</sub>	Propagation delay	A to B	CEC Channels Enabled		437		ns
		B to A			267		
t <sub>PLH</sub>		A to B			13		μs
		B to A			0.264		
t <sub>f</sub>	A port fall time	A Port	CEC Channels Enabled		110		ns
	B port fall time	B Port			96		
t <sub>r</sub>	A port rise time	A Port	CEC Channels Enabled		202		ns
	B port rise time	B Port			15		

**6.20 Switching Characteristics: Voltage Level Shifter: HPD Line (x\_A & x\_B ports); V<sub>CCA</sub> = 1.5 V**

 V<sub>CCA</sub> = 1.5 V

PARAMETER		PINS	TEST CONDITIONS	MIN	TYP	MAX	UNIT
t <sub>PLH</sub>	Propagation delay	B to A	CEC Channels Enabled		10		μs
t <sub>PLH</sub>		B to A			9		
t <sub>f</sub>	A port fall time	A Port	CEC Channels Enabled		0.47		ns
t <sub>r</sub>	A port rise time	A Port	CEC Channels Enabled		0.51		ns

**6.21 Switching Characteristics: Voltage Level Shifter: SCL, SDA Lines (x\_A & x\_B ports); V<sub>CCA</sub> = 1.8 V**

 V<sub>CCA</sub> = 1.8 V

PARAMETER		PINS	TEST CONDITIONS	MIN	TYP	MAX	UNIT
t <sub>PLH</sub>	Propagation delay	A to B	DDC Channels Enabled		334		ns
		B to A			229		
t <sub>PLH</sub>		A to B			431		
		B to A			169		
t <sub>f</sub>	A port fall time	A Port	DDC Channels Enabled		94		ns
	B port fall time	B Port			83		
t <sub>r</sub>	A port rise time	A Port	DDC Channels Enabled		191		ns
	B port rise time	B Port			92		
f <sub>MAX</sub>	Maximum switching frequency		DDC Channels Enabled	400			kHz

**6.22 Switching Characteristics: Voltage Level Shifter: CEC Line (x\_A & x\_B ports); V<sub>CCA</sub> = 1.8 V**

 V<sub>CCA</sub> = 1.8 V

PARAMETER		PINS	TEST CONDITIONS	MIN	TYP	MAX	UNIT
t <sub>PLH</sub>	Propagation delay	A to B	CEC Channels Enabled		441		ns
		B to A			231		
t <sub>PLH</sub>		A to B			13		μs
		B to A			0.26		
t <sub>f</sub>	A port fall time	A Port	CEC Channels Enabled		94		ns
	B port fall time	B Port			96		
t <sub>r</sub>	A port rise time	A Port	CEC Channels Enabled		201		ns
	B port rise time	B Port			15		

**6.23 Switching Characteristics: Voltage Level Shifter: HPD Line (x\_A & x\_B ports); V<sub>CCA</sub> = 1.8 V**

 V<sub>CCA</sub> = 1.8 V

PARAMETER		PINS	TEST CONDITIONS	MIN	TYP	MAX	UNIT
t <sub>PLH</sub>	Propagation delay	B to A	CEC Channels Enabled		10		μs
t <sub>PLH</sub>		B to A			9		
t <sub>f</sub>	A port fall time	A Port	CEC Channels Enabled		0.41		ns
t <sub>r</sub>	A port rise time	A Port	CEC Channels Enabled		0.45		ns

**TPD12S015A**

SLLSE74D – JUNE 2011 – REVISED JULY 2016

[www.ti.com](http://www.ti.com)
**6.24 Switching Characteristics: Voltage Level Shifter: SCL, SDA Lines (x\_A & x\_B ports); V<sub>CCA</sub> = 2.5 V**

 V<sub>CCA</sub> = 2.5 V

PARAMETER		PINS	TEST CONDITIONS	MIN	TYP	MAX	UNIT
t <sub>PLH</sub>	Propagation delay	A to B	DDC Channels Enabled		330		ns
		B to A			182		
t <sub>PLH</sub>		A to B			423		
		B to A			166		
t <sub>f</sub>	A port fall time	A Port	DDC Channels Enabled		79		ns
	B port fall time	B Port			83		
t <sub>r</sub>	A port rise time	A Port	DDC Channels Enabled		188		ns
	B port rise time	B Port			92		
f <sub>MAX</sub>	Maximum switching frequency		DDC Channels Enabled	400			kHz

**6.25 Switching Characteristics: Voltage Level Shifter: CEC Line (x\_A & x\_B ports); V<sub>CCA</sub> = 2.5 V**

 V<sub>CCA</sub> = 2.5 V

PARAMETER		PINS	TEST CONDITIONS	MIN	TYP	MAX	UNIT
t <sub>PLH</sub>	Propagation delay	A to B	CEC Channels Enabled		454		ns
		B to A			184		
t <sub>PLH</sub>		A to B			13		μs
		B to A			0.255		
t <sub>f</sub>	A port fall time	A Port	CEC Channels Enabled		79		ns
	B port fall time	B Port			96		
t <sub>r</sub>	A port rise time	A Port	CEC Channels Enabled		194		ns
	B port rise time	B Port			15		

**6.26 Switching Characteristics: Voltage Level Shifter: HPD Line (x\_A & x\_B ports); V<sub>CCA</sub> = 2.5 V**

 V<sub>CCA</sub> = 2.5 V

PARAMETER		PINS	TEST CONDITIONS	MIN	TYP	MAX	UNIT
t <sub>PLH</sub>	Propagation delay	B to A	CEC Channels Enabled		10		μs
t <sub>PLH</sub>		B to A			9		
t <sub>f</sub>	A port fall time	A Port	CEC Channels Enabled		0.37		ns
t <sub>r</sub>	A port rise time	A Port	CEC Channels Enabled		0.39		ns

**6.27 Switching Characteristics: Voltage Level Shifter: SCL, SDA Lines (x\_A & x\_B ports); V<sub>CCA</sub> = 3.3 V**

 V<sub>CCA</sub> = 3.3 V

PARAMETER		PINS	TEST CONDITIONS	MIN	TYP	MAX	UNIT
t <sub>PLH</sub>	Propagation delay	A to B	DDC channels enabled		323		ns
		B to A			158		
t <sub>PLH</sub>		A to B			421		
		B to A			162		
t <sub>f</sub>	A port fall time	A Port	DDC channels enabled		71		ns
	B port fall time	B Port			84		
t <sub>r</sub>	A port rise time	A Port	DDC channels enabled		188		ns
	B port rise time	B Port			92		
f <sub>MAX</sub>	Maximum switching frequency		DDC channels enabled	400			kHz

**6.28 Switching Characteristics: Voltage Level Shifter: CEC Line (x\_A & x\_B ports);  $V_{CCA} = 3.3\text{ V}$** 
 $V_{CCA} = 3.3\text{ V}$ 

PARAMETER		PINS	TEST CONDITIONS	MIN	TYP	MAX	UNIT
$t_{PLH}$	Propagation delay	A to B	CEC channels enabled		450		ns
		B to A			160		
$t_{PLH}$		A to B			13		$\mu\text{s}$
		B to A			0.251		
$t_f$	A port fall time	A Port	CEC channels enabled		71		ns
	B port fall time	B Port			96		
$t_r$	A port rise time	A Port	CEC channels enabled		194		ns
	B port rise time	B Port			15		$\mu\text{s}$

**6.29 Switching Characteristics: Voltage Level Shifter: HPD Line (x\_A & x\_B ports);  $V_{CCA} = 3.3\text{ V}$** 
 $V_{CCA} = 3.3\text{ V}$ 

PARAMETER		PINS	TEST CONDITIONS	MIN	TYP	MAX	UNIT
$t_{PLH}$	Propagation delay	B to A	CEC channels enabled		10		$\mu\text{s}$
		B to A			9		
$t_f$	A port fall time	A Port	CEC channels enabled		0.35		ns
$t_r$	A port rise time	A Port	CEC channels enabled		0.37		ns

### 6.30 Typical Characteristics

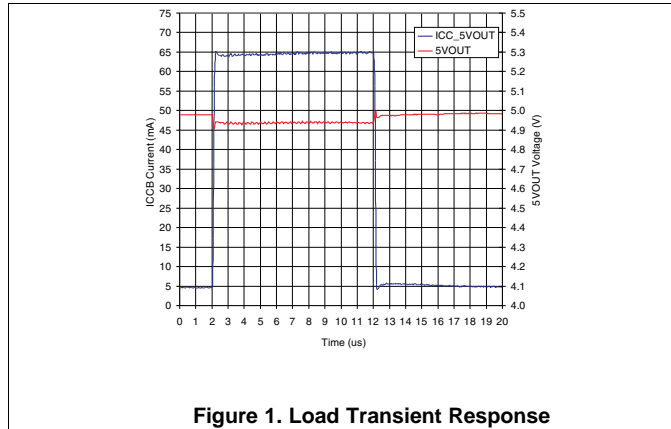

Figure 1. Load Transient Response

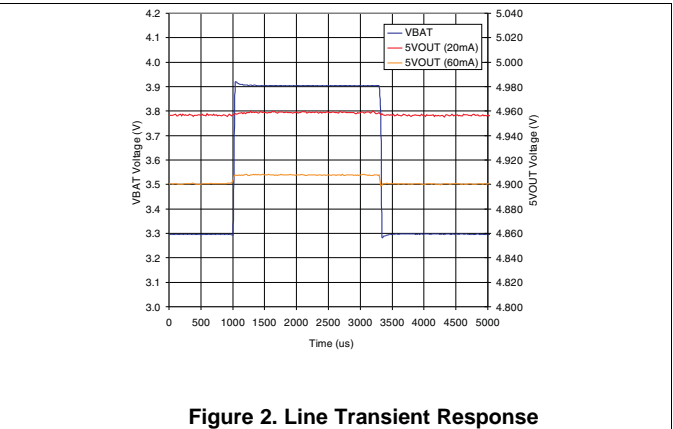

Figure 2. Line Transient Response

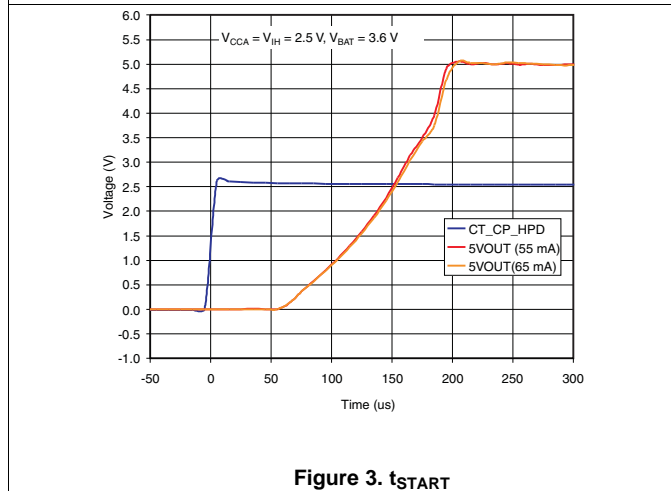

Figure 3.  $t_{START}$

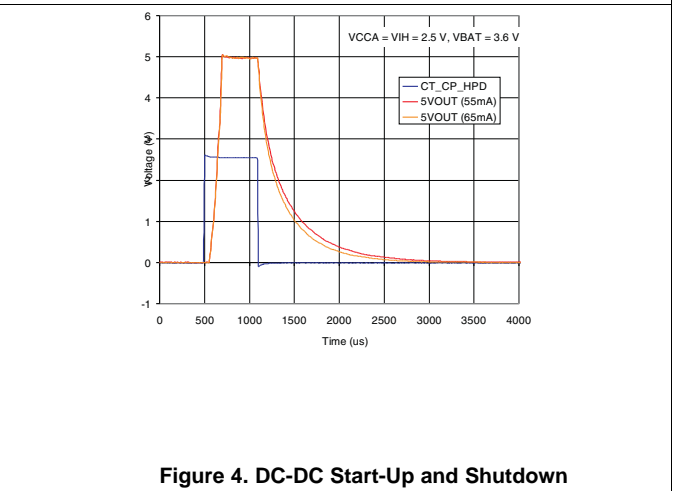

Figure 4. DC-DC Start-Up and Shutdown

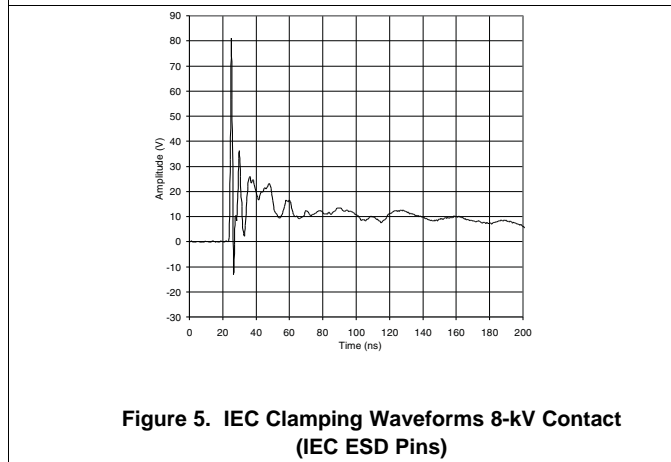

Figure 5. IEC Clamping Waveforms 8-kV Contact (IEC ESD Pins)

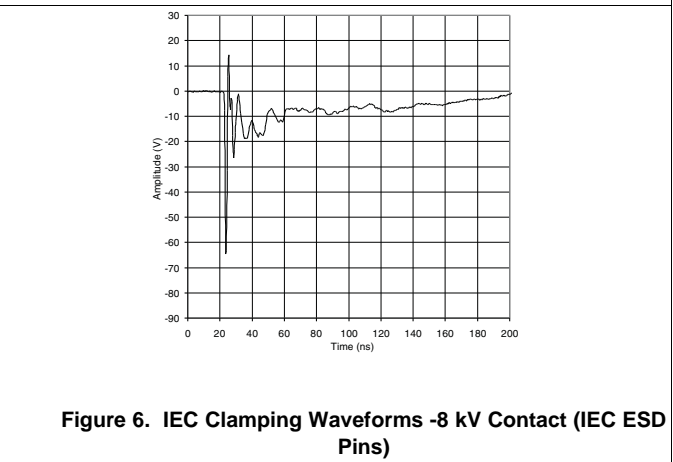

Figure 6. IEC Clamping Waveforms -8 kV Contact (IEC ESD Pins)

Typical Characteristics (continued)

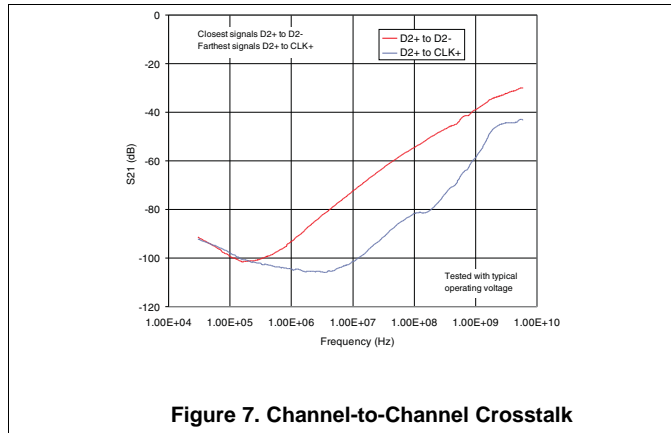

Figure 7. Channel-to-Channel Crosstalk

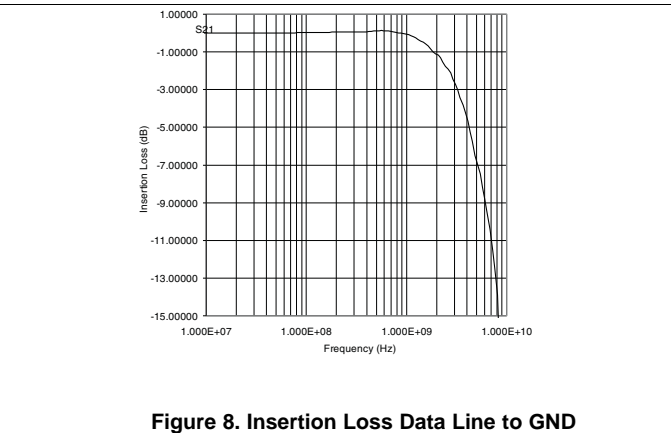

Figure 8. Insertion Loss Data Line to GND

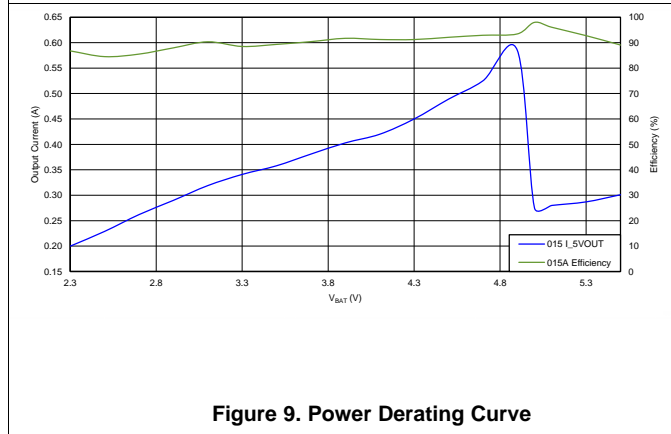

Figure 9. Power Derating Curve

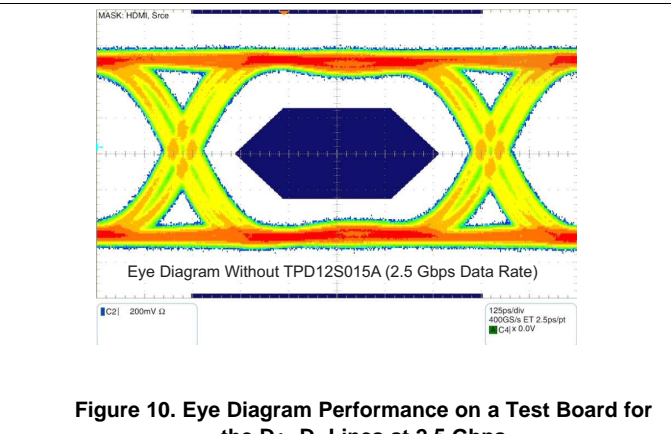

Figure 10. Eye Diagram Performance on a Test Board for the D+, D- Lines at 2.5 Gbps

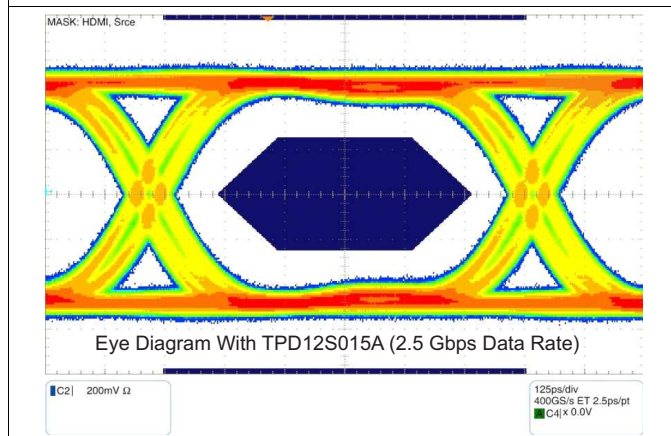

Figure 11. Eye Diagram Performance on a Test Board for the D+, D- Lines at 2.5 Gbps

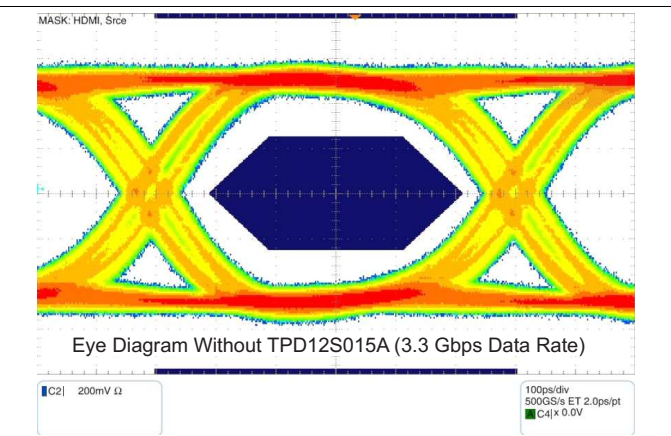
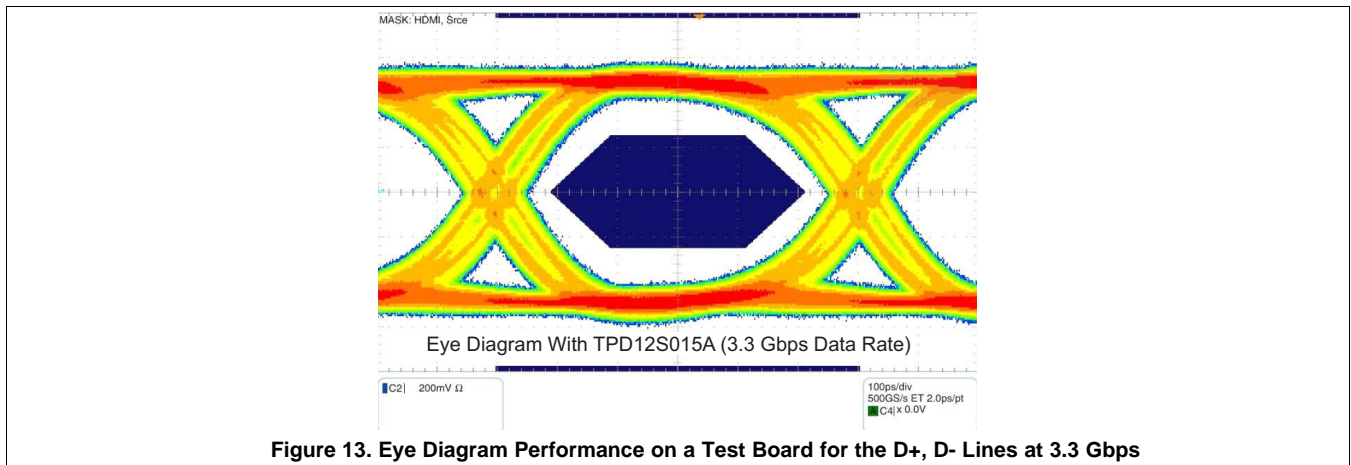

Figure 12. Eye Diagram Performance on a Test Board for the D+, D- Lines at 3.3 Gbps

**Typical Characteristics (continued)**



**Figure 13. Eye Diagram Performance on a Test Board for the D+, D- Lines at 3.3 Gbps**



## 7 Parameter Measurement Information

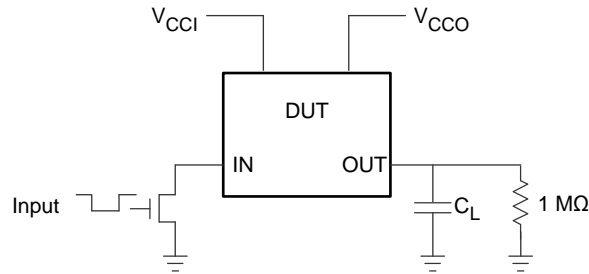

Copyright © 2016, Texas Instruments Incorporated

PIN	$C_L$
DDC, CEC (A side)	750 pF
DDC, CEC, HPD (B side)	15 pF

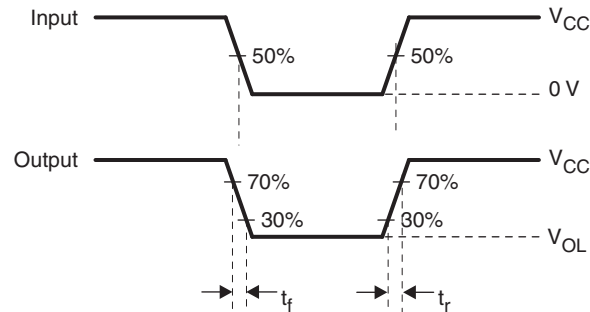

- A.  $R_T$  termination resistance must be equal to  $Z_{OUT}$  of pulse generators.
- B.  $C_L$  includes probe and jig capacitance.
- C. All input pulses are supplied by generators having the following characteristics:  $PRR \leq 10$  MHz,  $Z_O = 50 \Omega$ , slew rate  $\geq 1$  V/ns.
- D. The outputs are measured one at a time, with one transition per measurement.
- E.  $t_{PLH}$  and  $t_{PHL}$  are the same as  $t_{pd}$ .

**Figure 14. Test Circuit and Voltage Waveforms**

## 8 Detailed Description

### 8.1 Overview

The TPD12S015A is an integrated interface solution for HDMI 1.3/1.4 interfaces, for both portable and non-portable electronics applications. It has a boost DC-DC converter that uses the 2.3-V to 5.5-V internal power supply and outputs regulated 5-V standard compliant power supply to the cable. This power supply output has current limit and short-circuit protection function. There are bidirectional level shifting and signal conditioning circuits on CEC, SCL, SDA with pullup resistors integrated to minimize the external passive discrete component use. There is also a unidirectional level shifter for HPD signal that translates the 5-V HPD down to  $V_{CCA}$  level. The HPD\_B port has a glitch filter to avoid false detection due to the bouncing while inserting the HDMI plug. For the eight TMDs lines, there are high-speed ESD diodes on each line to make sure that the system pass 8-kV contact ESD.

### 8.2 Functional Block Diagram

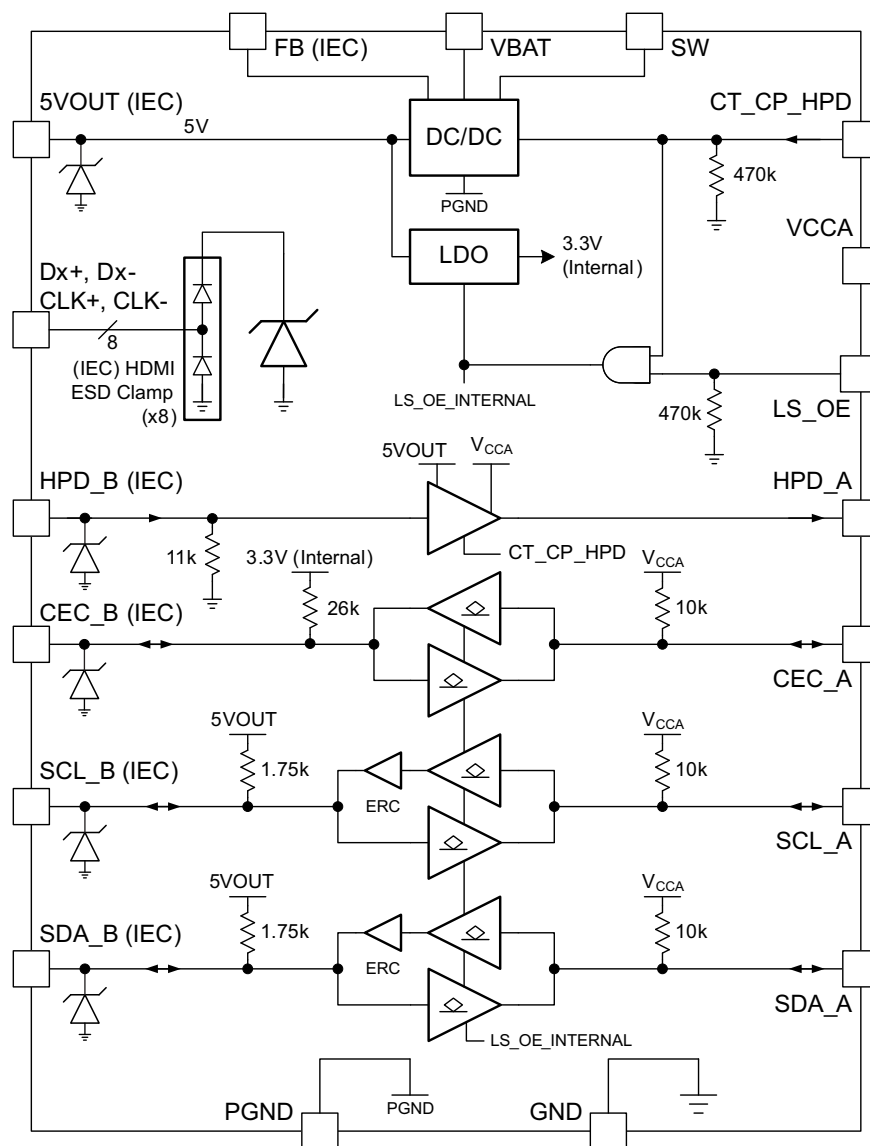

Copyright © 2016, Texas Instruments Incorporated

3.3 V (Internal) is an internally generated voltage node for the CEC\_B output buffer supply reference. An LDO generates this 3.3 V from 5VOUT when LS\_OE = H & CT\_CP\_HPDP = H.

## 8.3 Feature Description

### 8.3.1 Rise-Time Accelerators

The HDMI cable side of the DDC lines incorporates rise-time accelerators to support the high capacitive load on the HDMI cable side. The rise time accelerator boosts the cable side DDC signal independent of which side of the bus is releasing the signal.

### 8.3.2 Internal Pullup Resistor

The TPD12S015A has incorporated all the required pullup and pulldown resistors at the interface pins. The system is designed to work properly with no external pullup resistors on the DDC, CEC, and HPD lines. For proper system operation, no external resistors must be placed at the A and B ports. If there is internal pullups at the host processor, they must be disabled.

### 8.3.3 Undervoltage Lockout

The undervoltage lockout circuit prevents the DC-DC converter from malfunctioning at low input voltages and from excessive discharge of the battery. It disables the output stage of the converter once the falling  $V_{IN}$  trips the undervoltage lockout threshold  $V_{BATUV}$ . The undervoltage lockout threshold  $V_{BATUV}$  for falling  $V_{IN}$  is typically 2 V. The device starts operation once the rising  $V_{IN}$  trips undervoltage lockout threshold  $V_{BATUV}$  again at typical 2.1 V.

### 8.3.4 Soft Start

The DC-DC converter has an internal soft-start circuit that controls the ramp-up of the output voltage. The output voltage reaches its nominal value within  $t_{start}$  of typically 250  $\mu$ s after CT\_CP\_HPDP pin has been pulled to high level. The output voltage ramps up from 5% to its nominal value within  $t_{ramp}$  of 300  $\mu$ s. This limits the inrush current in the converter during start-up, and prevents possible input voltage drops when a battery or high impedance power source is used. During soft start, the switch current limit is reduced to 300 mA until the output voltage reaches  $V_{IN}$ . Once the output voltage trips this threshold, the device operates with its nominal current limit ILIMF.

### 8.3.5 DDC/CEC Level Shifting Function

The TPD12S015A enables DDC translation from  $V_{CCA}$  (system side) voltage levels to 5-V (HDMI cable side) voltage levels without degradation of system performance. The TPD12S015A contains two bidirectional open-drain buffers specifically designed to support up-translation and down-translation between the low voltage,  $V_{CCA}$  side DDC-bus and the 5-V DDC-bus. The port B I/Os are overvoltage tolerant to 5.5 V even when the device is unpowered. After power up and with the LS\_OE and CT\_CP\_HPDP pins high, a low level on port A (below approximately  $V_{ILC} = 0.08 \times V_{CCA}$  V) turns the corresponding port B driver (either SDA or SCL) on and drives port B down to  $V_{OLB}$  V. When port A rises above approximately  $0.10 \times V_{CCA}$  V, the port B pulldown driver is turned off, and the internal pullup resistor pulls the pin high. When port B falls first and goes below  $0.3 \times 5V_{OUT}$ , a CMOS hysteresis input buffer detects the falling edge, turns on the port A driver, and pulls port A down to approximately  $V_{OLA} = 0.16 \times V_{CCA}$  V. The port B pulldown is not enabled unless the port A voltage goes below  $V_{ILC}$ . If the port A low voltage goes below  $V_{ILC}$ , the port B pulldown driver is enabled until port A rises above  $(V_{ILC} + \Delta V_{T-HYSTA})$ ; then port B, if not externally driven LOW, continues to rise being pulled up by the internal pullup resistor.

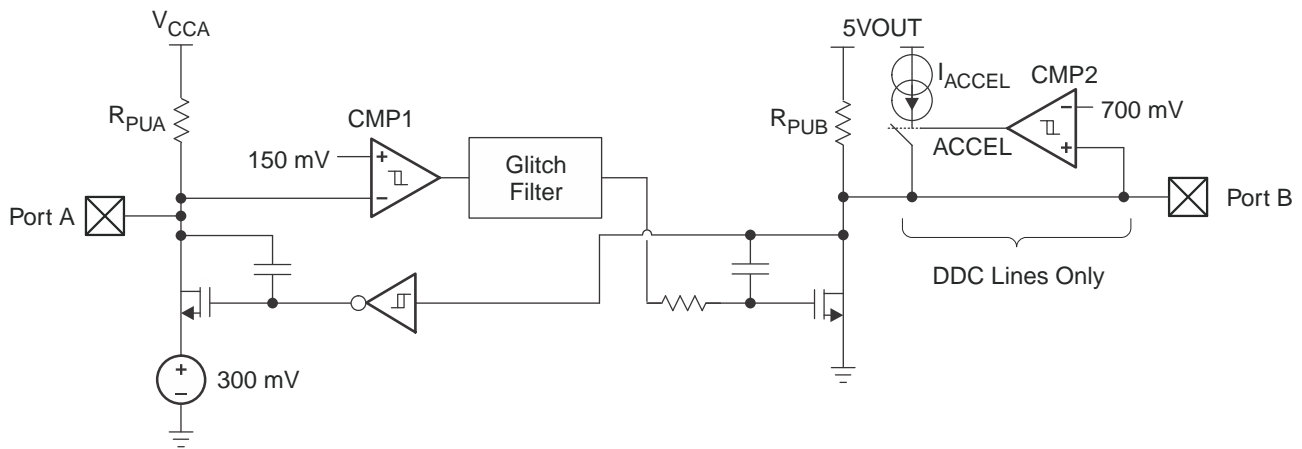
**Feature Description (continued)**

Copyright © 2016, Texas Instruments Incorporated

**Figure 15. DDC/CEC Level Shifter Block Diagram**
**8.3.6 DDC/CEC Level Shifting Function When  $V_{CCA} = 1.8\text{ V}$** 

- The threshold of CMP1 is approximately  $150\text{ mV} \pm$  the  $40\text{ mV}$  of total hysteresis.
- The comparator trips for a falling waveform at approximately  $130\text{ mV}$
- The comparator trips for a rising waveform at approximately  $170\text{ mV}$
- To be recognized as a zero, the level at Port A must first go below  $130\text{ mV}$  (VILC in spec) and then stay below  $170\text{ mV}$  (VILA in spec)
- To be recognized as a one, the level at A must first go above  $170\text{ mV}$  and then stay above  $130\text{ mV}$
- VILC is set to  $110\text{ mV}$  to give some margin to the  $130\text{ mV}$
- VILA is set to  $140\text{ mV}$  to give some margin to the  $170\text{ mV}$
- VIHA is set to  $70\%$  of  $V_{CCA}$  to be consistent with standard CMOS levels

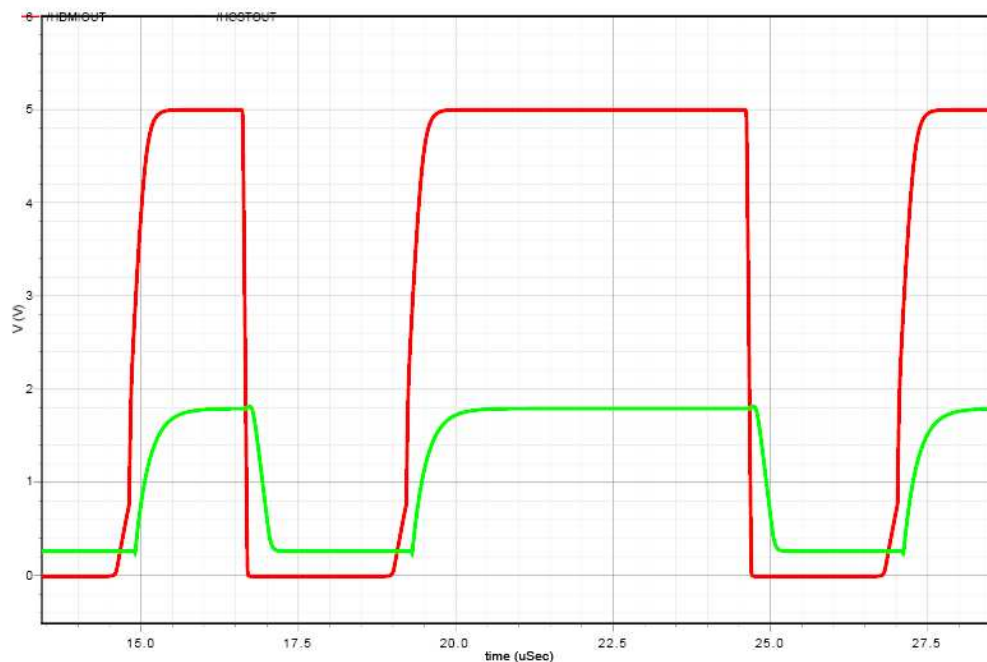
**Figure 16. DDC/CEC Level Shifter Operation (B to A Direction)**

## Feature Description (continued)

### 8.3.7 CEC Level Shifting Function

The CEC level shift function operates in the same manner as the DDC lines except that the CEC line does not need the rise time accelerator function.

## 8.4 Device Functional Modes

### 8.4.1 Enable

The DC-DC converter is enabled when the CT\_CP\_HPDP is set to high. At first, the internal reference is activated and the internal analog circuits are settled. Afterwards, the soft start is activated and the output voltage is ramped up. The output voltage reaches its nominal value in typically 250  $\mu$ s after the device has been enabled. The CT\_CP\_HPDP input can be used to control power sequencing in a system with various DC-DC converters. The CT\_CP\_HPDP pin can be connected to the output of another converter, to drive the EN pin high and getting a sequencing of supply rails. With CT\_CP\_HPDP = GND, the DC-DC enters shutdown mode.

### 8.4.2 Power Save Mode

The TPD12S015A integrates a power save mode to improve efficiency at light load. In power save mode the converter only operates when the output voltage trips below a set threshold voltage. It ramps up the output voltage with several pulses and goes into power save mode once the output voltage exceeds the set threshold voltage. The PFM mode is left and PWM mode entered in case the output current can not longer be supported in PFM mode.

**Table 2. System Block Diagram Function Table**

LS_OE	CT_CP_HPDP	V <sub>CCA</sub>	VBAT	5VOUT	A-SIDE	DDC, B-SIDE	CEC, B-SIDE	CEC LDO	DC-DC & HPDP	DDC/CEC	ICC V <sub>CCA</sub>	ICC VBAT	COMMENT
					PULLUPS	PULLUPS	PULLUPS			VLTs	TYP	TYP	
L	L	1.8 V	3.3 V	Off	Off	Off	Off	Off	Off	Off	1 $\mu$ A	1 $\mu$ A	Fully Disabled
L	H	1.8 V	3.3 V	On	On	On	Off	Off	On	Off	1 $\mu$ A	30 $\mu$ A	DC-DC on
H	L	1.8 V	3.3 V	Off	Off	Off	Off	Off	Off	Off	1 $\mu$ A	1 $\mu$ A	Not Valid State
H	H	1.8 V	3.3 V	On	On	On	On	On	On	On	13 $\mu$ A	255 $\mu$ A	Fully On
X	X	0 V	0 V	Off	High-Z	High-Z	High-Z	Off	Off	Off	0	0	Power Down
X	X	1.8 V	0 V	Off	Low	High-Z	High-Z	Off	Off	Off	0	0	Power Down
X	X	0 V	3.3 V	Off	High-Z	High-Z	High-Z	Off	Off	Off	0	0	Power Down

## 9 Application and Implementation

### NOTE

Information in the following applications sections is not part of the TI component specification, and TI does not warrant its accuracy or completeness. TI's customers are responsible for determining suitability of components for their purposes. Customers must validate and test their design implementation to confirm system functionality.

### 9.1 Application Information

The TPD12S015A is an integrated solution for HDMI 1.3/1.4 interface. The device has a boost converter on the power supply, signal conditioning circuits on CEC, SCL, SDA, HPD lines, and ESD protection on the TMDS lines. To get the best performance, see [Design Requirements](#), [Detailed Design Procedure](#), and [Application Curves](#).

### 9.2 Typical Applications

Some HDMI controller chips may have two GPIOs to control the HDMI interface chip. [Figure 17](#) shows how TPD12S015A is used in this situation. Whereas some HDMI driver chips may have only one GPIO (CT\_CP\_HPDP) available. In this situation, LE\_OE pin is tied to HPD\_A instead. [Figure 18](#) shows how TPD12S015A is used in this situation.

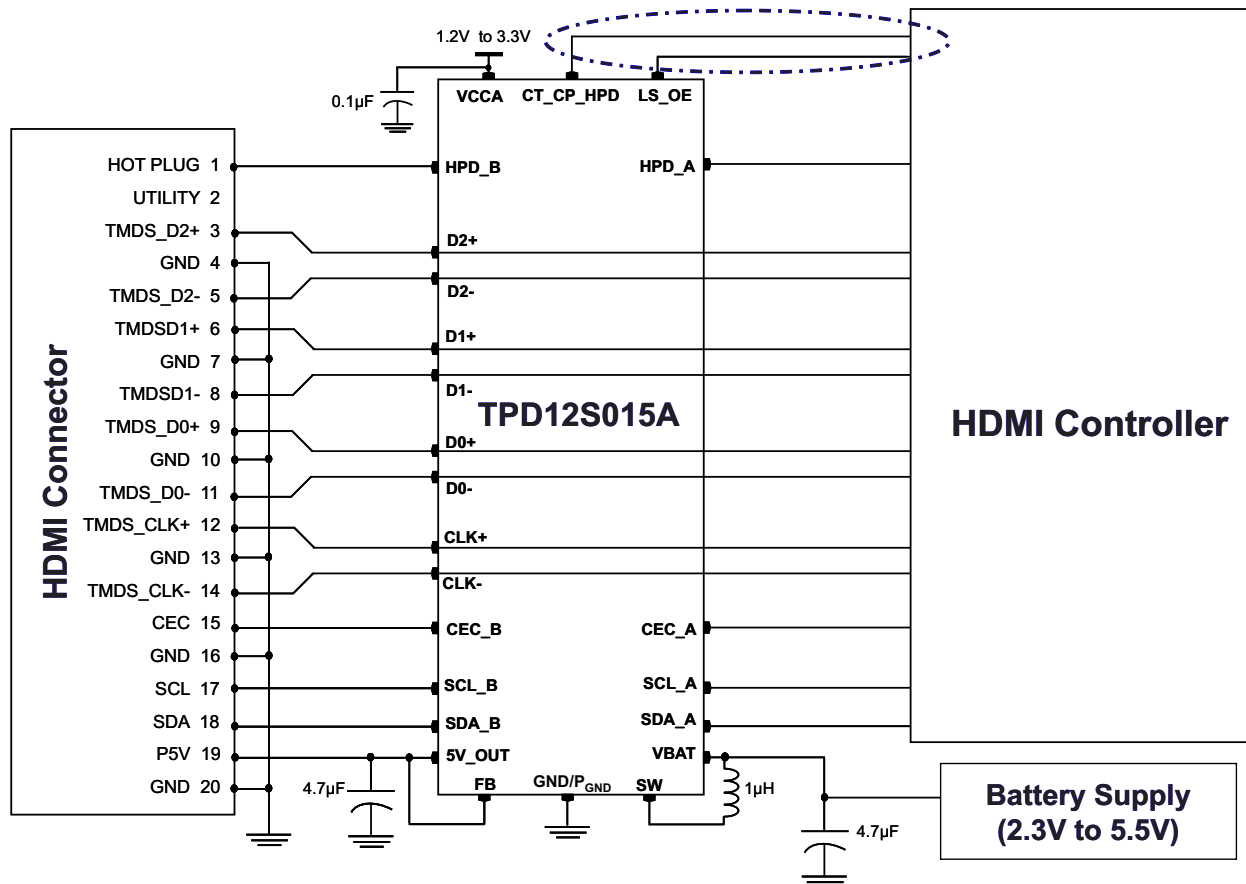

Copyright © 2016, Texas Instruments Incorporated

**Figure 17. Application Schematics for HDMI Controllers With Two GPIOs for HDMI Interface Control**

Typical Applications (continued)

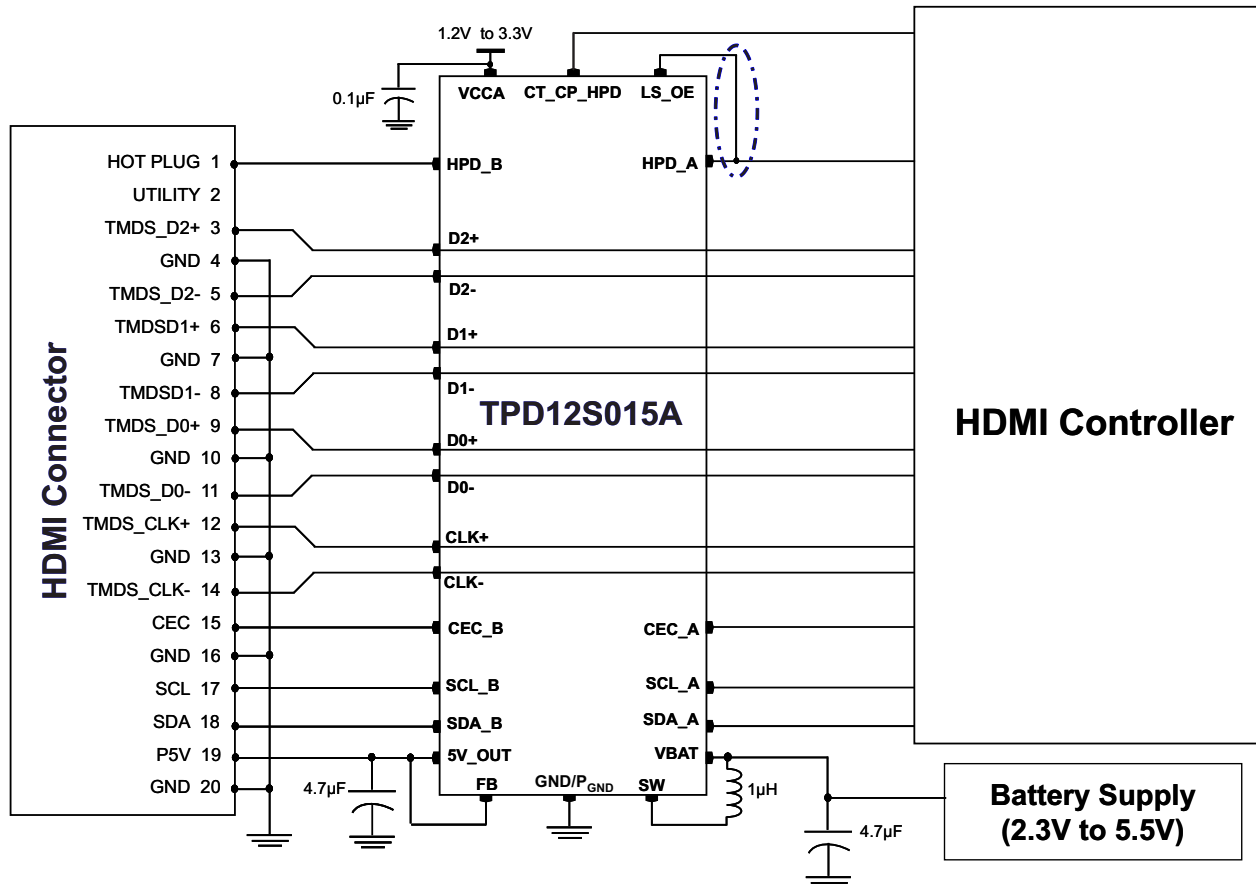

Copyright © 2016, Texas Instruments Incorporated

Figure 18. Application Schematics for HDMI Controllers With One GPIO for HDMI Interface Control

9.2.1 Design Requirements

Table 3 lists the known system parameters for an HDMI 1.3/1.4 application.

Table 3. Design Parameters

DESIGN PARAMETER	VALUE
5V_OUT DC current	55 mA
CEC_A, HPD_A, SCL_A, SDA_A voltage level	V <sub>CCA</sub>
HDMI data rate per TMDS signal pair	3.4 Gbps
Required IEC 61000-4-2 ESD Protection	±8-kV Contact

9.2.2 Detailed Design Procedure

9.2.2.1 Inductor Selection

To make sure that the TPD12S015A devices can operate, an inductor must be connected between pin V<sub>BAT</sub> and pin SW. A boost converter normally requires two main passive components for storing energy during the conversion. A boost inductor and a storage capacitor at the output are required. To select the boost inductor, TI recommends keeping the possible peak inductor current below the current limit threshold of the power switch in the chosen configuration. The highest peak current through the inductor and the switch depends on the output load, the input (V<sub>BAT</sub>), and the output voltage (5V<sub>OUT</sub>). Use Equation 1 to estimate the maximum average inductor current.

$$I_{L\_MAX} \approx I_{OUT} \times \frac{V_{OUT}}{\eta \times V_{IN}} \quad (1)$$

For example, for an output current of 55 mA at 5V<sub>OUT</sub>, approximately 150 mA of average current flows through the inductor at a minimum input voltage of 2.3 V.

The second parameter for choosing the inductor is the desired current ripple in the inductor. Normally, it is advisable to work with a ripple of less than 20% of the average inductor current. A smaller ripple reduces the magnetic hysteresis losses in the inductor, as well as output voltage ripple and EMI. However, in the same way, regulation time at load changes rises. In addition, a larger inductor increases the total system size and cost. With these parameters, it is possible to calculate the value of the minimum inductance by using [Equation 2](#).

$$L_{MIN} \approx \frac{V_{IN} \times (V_{OUT} - V_{IN})}{\Delta I_L \times f \times V_{OUT}}$$

where

- $f$  is the switching frequency
- $\Delta I_L$  is the ripple current in the inductor, that is,  $20\% \times I_L$

With this calculated value and the calculated currents, it is possible to choose a suitable inductor. In typical applications, TI recommends 1- $\mu$ H inductance. The device has been optimized to operate with inductance values between 1  $\mu$ H and 1.3  $\mu$ H. TI recommends using at least 1- $\mu$ H inductance, even if [Equation 2](#) yields something lower. Take care so that load transients and losses in the circuit can lead to higher currents as estimated in [Equation 3](#). Also, the losses in the inductor caused by magnetic hysteresis losses and copper losses are a major parameter for total circuit efficiency.

With the chosen inductance value, the peak current for the inductor in steady state operation can be calculated. [Equation 3](#) shows how to calculate the peak current  $I$ .

$$I_{L(peak)} = \frac{V_{IN} \times D}{2 \times f \times L} + \frac{I_{OUT}}{(1-D) \times \eta}$$

$$\text{where } D = \frac{V_{OUT} - V_{IN}}{V_{OUT}} \quad (3)$$

This would be the critical value for the current rating for selecting the inductor. It also must be considered that load transients and error conditions may cause higher inductor currents.

### 9.2.2.2 Input Capacitor

Because of the nature of the boost converter having a pulsating input current, a low ESR input capacitor is required to prevent large voltage transients that can cause misbehavior of the device or interferences with other circuits in the system. TI recommends at least a 1.2- $\mu$ F input capacitor to improve transient behavior of the regulator and EMI behavior of the total power supply circuit. TI recommends placing a ceramic capacitor as close as possible to the  $V_{IN}$  and GND pins; to improve the input noise filter, it is better to use a 4.7- $\mu$ F capacitor.

### 9.2.2.3 Output Capacitor

For the output capacitor, TI recommends using small ceramic capacitors placed as close as possible to the  $V_{OUT}$  and GND pins of the IC. If, for any reason, the application requires the use of large capacitors, which cannot be placed close to the IC, TI recommends using a smaller ceramic capacitor in parallel to the large one. This small capacitor must be placed as close as possible to the  $V_{OUT}$  and GND pins of the IC. To get an estimate of the recommended minimum output capacitance, use [Equation 4](#).

$$C_{min} = \frac{I_{OUT} \times (V_{OUT} - V_{IN})}{f \times \Delta V \times V_{OUT}}$$

where

- $f$  is the switching frequency
- $\Delta V$  is the maximum allowed ripple



With a chosen ripple voltage of 10 mV, a minimum effective capacitance of 2.7  $\mu\text{F}$  is needed. The total ripple is larger due to the ESR of the output capacitor. This additional component of the ripple can be calculated using [Equation 5](#).

$$\Delta V_{\text{ESR}} = I_{\text{OUT}} \times R_{\text{ESR}} \quad (5)$$

A capacitor with a value in the range of the calculated minimum must be used. This is required to maintain control loop stability. There are no additional requirements regarding minimum ESR. There is no upper limit for the output capacitance value. Larger capacitors cause lower output voltage ripple as well as lower output voltage drop during load transients.

Note that ceramic capacitors have a DC Bias effect, which will have a strong influence on the final effective capacitance needed. Therefore, the right capacitor value must be chosen very carefully. Package size and voltage rating in combination with material are responsible for differences between the rated capacitor value and the effective capacitance. The minimum effective capacitance value must be 1.2  $\mu\text{F}$ , but the preferred value is about 4.7  $\mu\text{F}$ .

**Table 4. Passive Components: Recommended Minimum Effective Values**

COMPONENT	MIN	TARGET	MAX	UNIT
C <sub>IN</sub>	1.2	4.7	6.5	$\mu\text{F}$
C <sub>OUT</sub>	1.2	4.7	10	$\mu\text{F}$
L <sub>IN</sub>	0.7	1	1.3	$\mu\text{H}$

#### 9.2.2.4 CEC, HPD, SCL, SDA Level Shifting Function

To accommodate for the lower logic levels of some processors' control lines, level shifters are needed to translate the interface voltage down to  $V_{\text{CCA}}$ , the voltage level used by the processor. The TPD12S015A has bidirectional level shifters on CEC, SCL, SDA lines to support the two-way communication. The pullup resistors are integrated to minimize the number of external components. For HPD line, only one way of hot-plug indication is needed, the level shifter is unidirectional. There is a built-in HPD\_B pulldown resistor to keep the voltage level low on the connector side when nothing is attached. Apart from the signal level translation, the rise-time accelerators on the connector side increases the load driving capability.

#### 9.2.2.5 ESD

To get the best ESD performance on the interface side pins, high performance ESD diodes are needed. The TPD12S015A's ESD diodes on D0+, D0-, D1+, D1-, D2+, D2-, CLK+, CLK-, SCL\_B, SDA\_B, CEC\_B, HPD\_B, 5VOUT, FB ensure passing 8-kV contact IEC, the highest level ESD. Signal integrity on TMDS lines is also a design concern that needs to be evaluated to meet the HDMI 1.3/1.4 data rate. With the typical I/O capacitance of 1.3 pF and a bandwidth above 3 GHz, [Figure 12](#) shows that TPD12S015A's ESD structure has enough margin to meet the data rate requirement of HDMI 1.3/1.4.

#### 9.2.2.6 Ground Offset Consideration

Ground offset between the TPD12S015A ground and the ground of devices on port A of the TPD12S015A must be avoided. The reason for this cautionary remark is that a CMOS/NMOS open-drain capable of sinking 3 mA of current at 0.4 V has an output resistance of 133  $\Omega$  or less. Such a driver shares enough current with the port A output pulldown of the TPD12S015A to be seen as a LOW as long as the ground offset is zero. If the ground offset is greater than 0 V, then the driver resistance must be less. Because VILC can be as low as 90 mV at cold temperatures and the low end of the current distribution, the maximum ground offset must not exceed 50 mV. Bus repeaters that use an output offset are not interoperable with the port A of the TPD12S015A as their output LOW levels are not recognized by the TPD12S015A as a LOW. If the TPD12S015A is placed in an application where the VIL of port A of the TPD12S015A does not go below its VILC, it pulls port B LOW initially when port A input transitions LOW but the port B returns HIGH, so it does not reproduce the port A input on port B. Such applications must be avoided. Port B is interoperable with all I<sup>2</sup>C bus slaves, masters, and repeaters.

TPD12S015A

SLLSE74D – JUNE 2011 – REVISED JULY 2016

www.ti.com

9.2.3 Application Curves

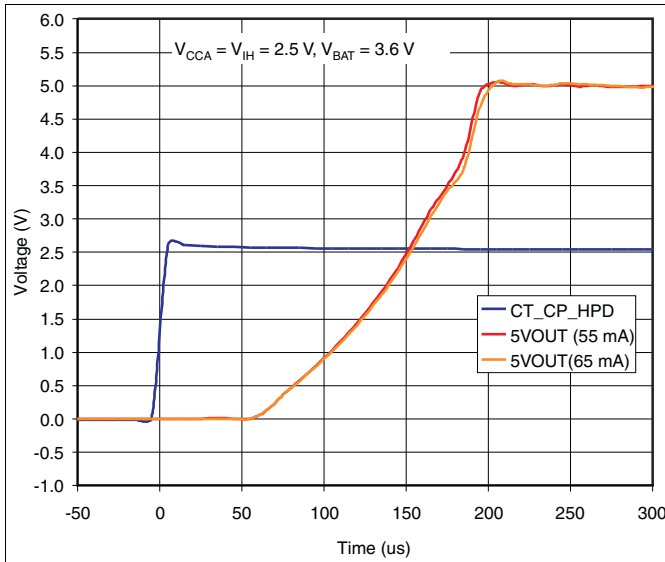

Figure 19.  $t_{START}$

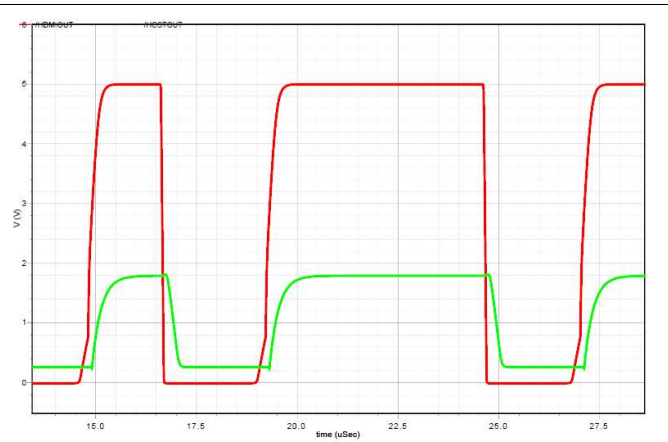

Figure 20. DDC/CEC Level Shifting Operation (B to A Direction)

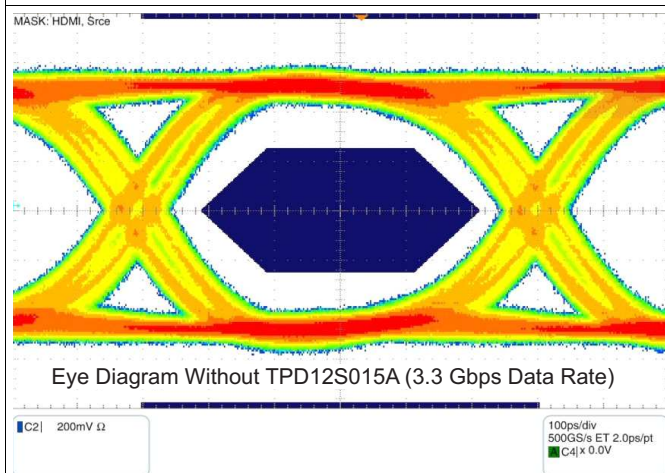

Figure 21. Eye Diagram Performance on a Test Board for the D+, D- Lines at 3.3 Gbps

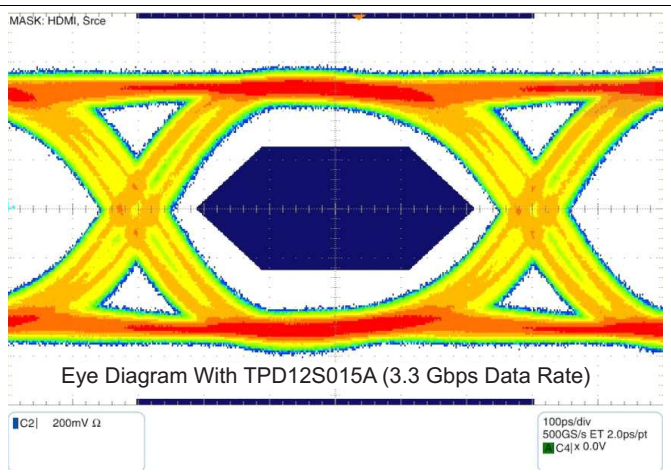

Figure 22. Eye Diagram Performance on a Test Board for the D+, D- Lines at 3.3 Gbps

## 10 Power Supply Recommendations

See [Detailed Design Procedure](#) for detailed power supply recommendations.

## 11 Layout

### 11.1 Layout Guidelines

For proper operation, follow these layout and design guidelines.

- Place the TPD12S015A as close to the connector as possible. This allows it to remove the energy associated with ESD strike before it reaches the internal circuitry of the system board.
- Place power line capacitors and inductors close to the pins with wide traces to allow enough current to flow through with less trace parasitics.
- Ensure that there is enough metallization for the GND pad. A sufficient current path enables safe discharge of all the energy associated with the ESD strike.
- The critical routing paths for HDMI interface are the high-speed TMDS lines. Make sure to match the lengths of the differential pair. Maintain constant trace width after to avoid impedance mismatches in the transmission lines. Maximize differential pair-to-pair spacing when possible.

### 11.2 Layout Example

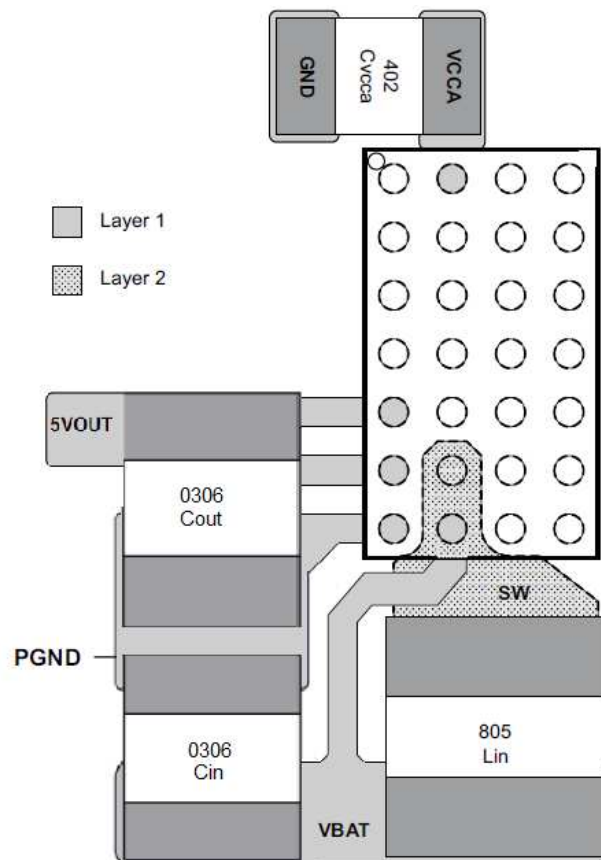

Figure 23. Board Layout (DC-DC Components) (Top View)

List of components:

- $L_{IN}$  = MURATA LQM21PN1R0MC0 (1  $\mu$ H, 800 mA, 0805, Shielded)
- $C_{IN}$  =  $C_{OUT}$  = MURATA LLL31MR70J475MA01 (4.7  $\mu$ F, Low ESL type, 6.3 V, 0306, X7R)
- $C_{VCCA}$  = MURATA GRM155R60J475ME87D (0.1  $\mu$ F, 6.3 V, 0402, X5R)

## 12 Device and Documentation Support

### 12.1 Documentation Support

#### 12.1.1 Related Documentation

For related documentation see the following:

[TPD12S015A EVM User's Guide](#) (SLVU485)

### 12.2 Receiving Notification of Documentation Updates

To receive notification of documentation updates, navigate to the device product folder on ti.com. In the upper right corner, click on *Alert me* to register and receive a weekly digest of any product information that has changed. For change details, review the revision history included in any revised document.

### 12.3 Community Resource

The following links connect to TI community resources. Linked contents are provided "AS IS" by the respective contributors. They do not constitute TI specifications and do not necessarily reflect TI's views; see TI's [Terms of Use](#).

**TI E2E™ Online Community** *TI's Engineer-to-Engineer (E2E) Community*. Created to foster collaboration among engineers. At [e2e.ti.com](http://e2e.ti.com), you can ask questions, share knowledge, explore ideas and help solve problems with fellow engineers.

**Design Support** *TI's Design Support* Quickly find helpful E2E forums along with design support tools and contact information for technical support.

### 12.4 Trademarks

E2E is a trademark of Texas Instruments.  
All other trademarks are the property of their respective owners.

### 12.5 Electrostatic Discharge Caution



This integrated circuit can be damaged by ESD. Texas Instruments recommends that all integrated circuits be handled with appropriate precautions. Failure to observe proper handling and installation procedures can cause damage.

ESD damage can range from subtle performance degradation to complete device failure. Precision integrated circuits may be more susceptible to damage because very small parametric changes could cause the device not to meet its published specifications.

### 12.6 Glossary

[SLYZ022](#) — *TI Glossary*.

This glossary lists and explains terms, acronyms, and definitions.

## 13 Mechanical, Packaging, and Orderable Information

The following pages include mechanical, packaging, and orderable information. This information is the most current data available for the designated devices. This data is subject to change without notice and revision of this document. For browser-based versions of this data sheet, refer to the left-hand navigation.

**PACKAGING INFORMATION**

Orderable Device	Status (1)	Package Type	Package Drawing	Pins	Package Qty	Eco Plan (2)	Lead/Ball Finish (6)	MSL Peak Temp (3)	Op Temp (°C)	Device Marking (4/5)	Samples
TPD12S015AYFFR	ACTIVE	DSBGA	YFF	28	3000	Green (RoHS & no Sb/Br)	SNAGCU	Level-1-260C-UNLIM	-40 to 85	PN015A	<b>Samples</b>

(1) The marketing status values are defined as follows:

**ACTIVE:** Product device recommended for new designs.

**LIFEBUY:** TI has announced that the device will be discontinued, and a lifetime-buy period is in effect.

**NRND:** Not recommended for new designs. Device is in production to support existing customers, but TI does not recommend using this part in a new design.

**PREVIEW:** Device has been announced but is not in production. Samples may or may not be available.

**OBSOLETE:** TI has discontinued the production of the device.

(2) Eco Plan - The planned eco-friendly classification: Pb-Free (RoHS), Pb-Free (RoHS Exempt), or Green (RoHS & no Sb/Br) - please check <http://www.ti.com/productcontent> for the latest availability information and additional product content details.

**TBD:** The Pb-Free/Green conversion plan has not been defined.

**Pb-Free (RoHS):** TI's terms "Lead-Free" or "Pb-Free" mean semiconductor products that are compatible with the current RoHS requirements for all 6 substances, including the requirement that lead not exceed 0.1% by weight in homogeneous materials. Where designed to be soldered at high temperatures, TI Pb-Free products are suitable for use in specified lead-free processes.

**Pb-Free (RoHS Exempt):** This component has a RoHS exemption for either 1) lead-based flip-chip solder bumps used between the die and package, or 2) lead-based die adhesive used between the die and leadframe. The component is otherwise considered Pb-Free (RoHS compatible) as defined above.

**Green (RoHS & no Sb/Br):** TI defines "Green" to mean Pb-Free (RoHS compatible), and free of Bromine (Br) and Antimony (Sb) based flame retardants (Br or Sb do not exceed 0.1% by weight in homogeneous material)

(3) MSL, Peak Temp. - The Moisture Sensitivity Level rating according to the JEDEC industry standard classifications, and peak solder temperature.

(4) There may be additional marking, which relates to the logo, the lot trace code information, or the environmental category on the device.

(5) Multiple Device Markings will be inside parentheses. Only one Device Marking contained in parentheses and separated by a "~" will appear on a device. If a line is indented then it is a continuation of the previous line and the two combined represent the entire Device Marking for that device.

(6) Lead/Ball Finish - Orderable Devices may have multiple material finish options. Finish options are separated by a vertical ruled line. Lead/Ball Finish values may wrap to two lines if the finish value exceeds the maximum column width.

**Important Information and Disclaimer:** The information provided on this page represents TI's knowledge and belief as of the date that it is provided. TI bases its knowledge and belief on information provided by third parties, and makes no representation or warranty as to the accuracy of such information. Efforts are underway to better integrate information from third parties. TI has taken and continues to take reasonable steps to provide representative and accurate information but may not have conducted destructive testing or chemical analysis on incoming materials and chemicals. TI and TI suppliers consider certain information to be proprietary, and thus CAS numbers and other limited information may not be available for release.

In no event shall TI's liability arising out of such information exceed the total purchase price of the TI part(s) at issue in this document sold by TI to Customer on an annual basis.



YFF (R-XBGA-N28)

DIE-SIZE BALL GRID ARRAY

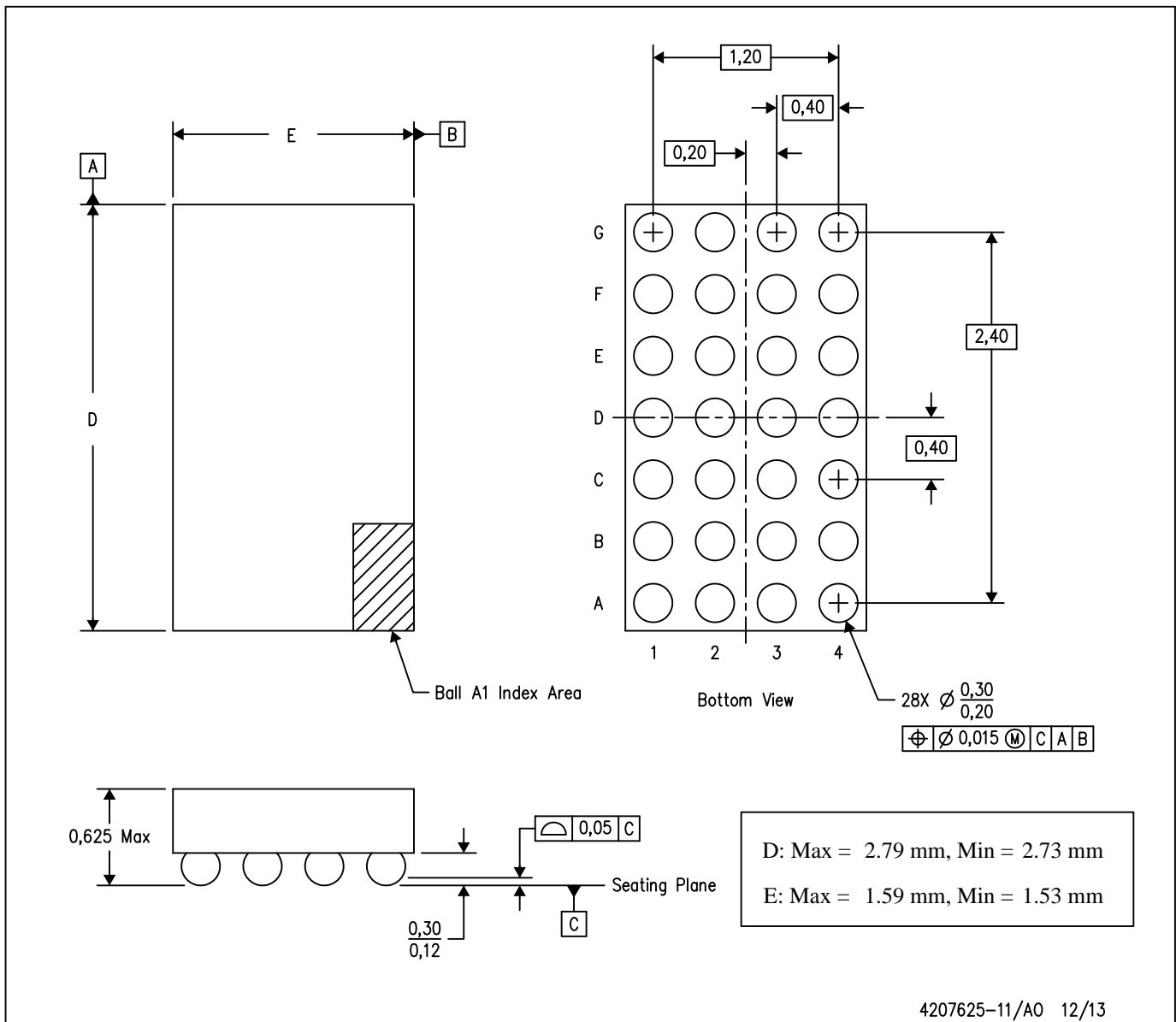

- NOTES:
- A. All linear dimensions are in millimeters. Dimensioning and tolerancing per ASME Y14.5M-1994.
  - B. This drawing is subject to change without notice.
  - C. NanoFree™ package configuration.

NanoFree is a trademark of Texas Instruments.

## IMPORTANT NOTICE

Texas Instruments Incorporated (TI) reserves the right to make corrections, enhancements, improvements and other changes to its semiconductor products and services per JESD46, latest issue, and to discontinue any product or service per JESD48, latest issue. Buyers should obtain the latest relevant information before placing orders and should verify that such information is current and complete.

TI's published terms of sale for semiconductor products (<http://www.ti.com/sc/docs/stdterms.htm>) apply to the sale of packaged integrated circuit products that TI has qualified and released to market. Additional terms may apply to the use or sale of other types of TI products and services.

Reproduction of significant portions of TI information in TI data sheets is permissible only if reproduction is without alteration and is accompanied by all associated warranties, conditions, limitations, and notices. TI is not responsible or liable for such reproduced documentation. Information of third parties may be subject to additional restrictions. Resale of TI products or services with statements different from or beyond the parameters stated by TI for that product or service voids all express and any implied warranties for the associated TI product or service and is an unfair and deceptive business practice. TI is not responsible or liable for any such statements.

Buyers and others who are developing systems that incorporate TI products (collectively, "Designers") understand and agree that Designers remain responsible for using their independent analysis, evaluation and judgment in designing their applications and that Designers have full and exclusive responsibility to assure the safety of Designers' applications and compliance of their applications (and of all TI products used in or for Designers' applications) with all applicable regulations, laws and other applicable requirements. Designer represents that, with respect to their applications, Designer has all the necessary expertise to create and implement safeguards that (1) anticipate dangerous consequences of failures, (2) monitor failures and their consequences, and (3) lessen the likelihood of failures that might cause harm and take appropriate actions. Designer agrees that prior to using or distributing any applications that include TI products, Designer will thoroughly test such applications and the functionality of such TI products as used in such applications.

TI's provision of technical, application or other design advice, quality characterization, reliability data or other services or information, including, but not limited to, reference designs and materials relating to evaluation modules, (collectively, "TI Resources") are intended to assist designers who are developing applications that incorporate TI products; by downloading, accessing or using TI Resources in any way, Designer (individually or, if Designer is acting on behalf of a company, Designer's company) agrees to use any particular TI Resource solely for this purpose and subject to the terms of this Notice.

TI's provision of TI Resources does not expand or otherwise alter TI's applicable published warranties or warranty disclaimers for TI products, and no additional obligations or liabilities arise from TI providing such TI Resources. TI reserves the right to make corrections, enhancements, improvements and other changes to its TI Resources. TI has not conducted any testing other than that specifically described in the published documentation for a particular TI Resource.

Designer is authorized to use, copy and modify any individual TI Resource only in connection with the development of applications that include the TI product(s) identified in such TI Resource. NO OTHER LICENSE, EXPRESS OR IMPLIED, BY ESTOPPEL OR OTHERWISE TO ANY OTHER TI INTELLECTUAL PROPERTY RIGHT, AND NO LICENSE TO ANY TECHNOLOGY OR INTELLECTUAL PROPERTY RIGHT OF TI OR ANY THIRD PARTY IS GRANTED HEREIN, including but not limited to any patent right, copyright, mask work right, or other intellectual property right relating to any combination, machine, or process in which TI products or services are used. Information regarding or referencing third-party products or services does not constitute a license to use such products or services, or a warranty or endorsement thereof. Use of TI Resources may require a license from a third party under the patents or other intellectual property of the third party, or a license from TI under the patents or other intellectual property of TI.

TI RESOURCES ARE PROVIDED "AS IS" AND WITH ALL FAULTS. TI DISCLAIMS ALL OTHER WARRANTIES OR REPRESENTATIONS, EXPRESS OR IMPLIED, REGARDING RESOURCES OR USE THEREOF, INCLUDING BUT NOT LIMITED TO ACCURACY OR COMPLETENESS, TITLE, ANY EPIDEMIC FAILURE WARRANTY AND ANY IMPLIED WARRANTIES OF MERCHANTABILITY, FITNESS FOR A PARTICULAR PURPOSE, AND NON-INFRINGEMENT OF ANY THIRD PARTY INTELLECTUAL PROPERTY RIGHTS. TI SHALL NOT BE LIABLE FOR AND SHALL NOT DEFEND OR INDEMNIFY DESIGNER AGAINST ANY CLAIM, INCLUDING BUT NOT LIMITED TO ANY INFRINGEMENT CLAIM THAT RELATES TO OR IS BASED ON ANY COMBINATION OF PRODUCTS EVEN IF DESCRIBED IN TI RESOURCES OR OTHERWISE. IN NO EVENT SHALL TI BE LIABLE FOR ANY ACTUAL, DIRECT, SPECIAL, COLLATERAL, INDIRECT, PUNITIVE, INCIDENTAL, CONSEQUENTIAL OR EXEMPLARY DAMAGES IN CONNECTION WITH OR ARISING OUT OF TI RESOURCES OR USE THEREOF, AND REGARDLESS OF WHETHER TI HAS BEEN ADVISED OF THE POSSIBILITY OF SUCH DAMAGES.

Unless TI has explicitly designated an individual product as meeting the requirements of a particular industry standard (e.g., ISO/TS 16949 and ISO 26262), TI is not responsible for any failure to meet such industry standard requirements.

Where TI specifically promotes products as facilitating functional safety or as compliant with industry functional safety standards, such products are intended to help enable customers to design and create their own applications that meet applicable functional safety standards and requirements. Using products in an application does not by itself establish any safety features in the application. Designers must ensure compliance with safety-related requirements and standards applicable to their applications. Designer may not use any TI products in life-critical medical equipment unless authorized officers of the parties have executed a special contract specifically governing such use. Life-critical medical equipment is medical equipment where failure of such equipment would cause serious bodily injury or death (e.g., life support, pacemakers, defibrillators, heart pumps, neurostimulators, and implantables). Such equipment includes, without limitation, all medical devices identified by the U.S. Food and Drug Administration as Class III devices and equivalent classifications outside the U.S.

TI may expressly designate certain products as completing a particular qualification (e.g., Q100, Military Grade, or Enhanced Product). Designers agree that it has the necessary expertise to select the product with the appropriate qualification designation for their applications and that proper product selection is at Designers' own risk. Designers are solely responsible for compliance with all legal and regulatory requirements in connection with such selection.

Designer will fully indemnify TI and its representatives against any damages, costs, losses, and/or liabilities arising out of Designer's non-compliance with the terms and provisions of this Notice.