

## TPDxF202 Four or Six-Channel EMI Filter With ESD Protection For LCD Display

### 1 Features

- Four or Six-Channel EMI Filtering and ESD Protection for Data Lines
- Excellent Filter Performance
  - > 40-dB Attenuation at 1 GHz to 3G Hz
  - –3-dB Bandwidth at 108 MHz
  - 70-dB Crosstalk Attenuation at 100 MHz
- Exceeds IEC 61000-4-2 (Level 4) ESD Protection Requirements
  - ±25-kV IEC 61000-4-2 Contact Discharge
  - ±25-kV IEC 61000-4-2 Air-Gap Discharge
  - ±15-kV Human Body Model (HBM)
- Pi-Style C-R-C Filter Configuration Offers Symmetric Filter Performance ( $R = 100 \Omega$ ,  $C_{TOTAL} = 30 \text{ pF}$ )
- Low 10-nA Leakage Current
- Space-Saving DSBGA Package and Flow-Through Pin Mapping Provide Optimum Performance in Portable Applications

### 2 Applications

- End Equipment:
  - LCD Displays
  - Memory Interface
  - Keypads
  - Portables
- Interfaces:
  - DVI
  - VGA, SVGA
  - SIM Cards
  - Data Lines

### 3 Description

The TPDxF202 devices are four or six-channel EMI filters, designed particularly to suppress EMI noise in the cell phone and other portable applications. These filters also provide a Transient Voltage Suppressor (TVS) diode circuit for Electrostatic Discharge (ESD) protection which prevents damage to the application when subjected to ESD stress far exceeding IEC 61000-4-2 (Level 4). The pi-style C-R-C filter provides symmetric filter performance in the data lines to and from either side of the filter.

Due to the tiny parasitics of the DSBGA package, the TPDxF202 filters provide excellent signal attenuation (–40 dB at 1 GHz) at the typical cell-phone carrier frequency ranges.

The ultra thin (0.3-mm package height, when mounted on board) space-saving YFU package enables the TPDxF202 devices to mount on the printed-circuit-boards where height is a key constraint.

The TPDxF202 devices are specified for –40°C to 85°C operation.

A typical application for TPDxF202 devices are in portable equipment with DVI, VGA, SVGA, SIM Card, and other data interfaces.

#### Device Information<sup>(1)</sup>

PART NUMBER	PACKAGE	BODY SIZE (NOM)
TPD4F202	DSBGA (10)	1.06 mm × 1.57 mm
TPD6F202	DSBGA (15)	1.06 mm × 2.63 mm

(1) For all available packages, see the orderable addendum at the end of the data sheet.

#### Functional Block Diagram

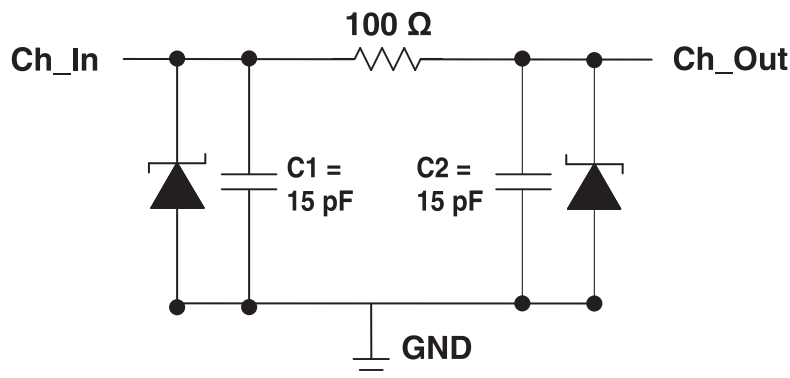

## Table of Contents

<b>1 Features</b> ..... 1 <b>2 Applications</b> ..... 1 <b>3 Description</b> ..... 1 <b>4 Revision History</b> ..... 2 <b>5 Pin Configuration and Functions</b> ..... 3 <b>6 Specifications</b> ..... 4 6.1 Absolute Maximum Ratings ..... 4 6.2 ESD Ratings — JEDEC ..... 5 6.3 ESD Ratings — IEC..... 5 6.4 Recommended Operating Conditions ..... 5 6.5 Thermal Information ..... 5 6.6 Electrical Characteristics..... 5 6.7 Typical Characteristics ..... 6 <b>7 Detailed Description</b> ..... 7 7.1 Overview ..... 7 7.2 Functional Block Diagram ..... 7 7.3 Feature Description..... 7	7.4 Device Functional Modes..... 7 <b>8 Application and Implementation</b> ..... 8 8.1 Application Information..... 8 8.2 Typical Application ..... 8 <b>9 Power Supply Recommendations</b> ..... 9 <b>10 Layout</b> ..... 10 10.1 Layout Guidelines ..... 10 10.2 Layout Example ..... 10 <b>11 Device and Documentation Support</b> ..... 11 11.1 Documentation Support ..... 11 11.2 Related Links ..... 11 11.3 Community Resources..... 11 11.4 Trademarks ..... 11 11.5 Electrostatic Discharge Caution..... 11 11.6 Glossary ..... 11 <b>12 Mechanical, Packaging, and Orderable Information</b> ..... 11
---	---

## 4 Revision History

NOTE: Page numbers for previous revisions may differ from page numbers in the current version.

Changes from Original (June 2010) to Revision A	Page
<ul style="list-style-type: none"> <li>• Added <i>Pin Configuration and Functions</i> section, <i>ESD Ratings</i> table, <i>Feature Description</i> section, <i>Device Functional Modes</i>, <i>Application and Implementation</i> section, <i>Power Supply Recommendations</i> section, <i>Layout</i> section, <i>Device and Documentation Support</i> section, and <i>Mechanical, Packaging, and Orderable Information</i> section ..... 1</li> <li>• Deleted <i>Ordering Information</i> section ..... 1</li> </ul>	1

## 5 Pin Configuration and Functions

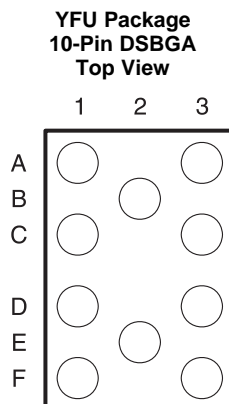

**Pin Functions — TPD4F202**

PIN		TYPE	DESCRIPTION
NO.	NAME		
A1	Ch1_In	I/O	ESD-protected channel, route to connector. Corresponds with CH1_Out.
A3	Ch1_Out	I/O	ESD-protected channel, route to system. Corresponds with CH1_In.
B2	GND	G	Ground
C1	Ch2_In	I/O	ESD-protected channel, route to connector. Corresponds with CH2_Out.
C3	Ch2_Out	I/O	ESD-protected channel, route to system. Corresponds with CH2_In.
D1	Ch3_In	I/O	ESD-protected channel, route to connector. Corresponds with CH3_Out.
D3	Ch3_Out	I/O	ESD-protected channel, route to system. Corresponds with CH3_In.
E2	GND	G	Ground
F1	Ch4_In	I/O	ESD-protected channel, route to connector. Corresponds with CH4_Out.
F3	Ch4_Out	I/O	ESD-protected channel, route to system. Corresponds with CH4_In.

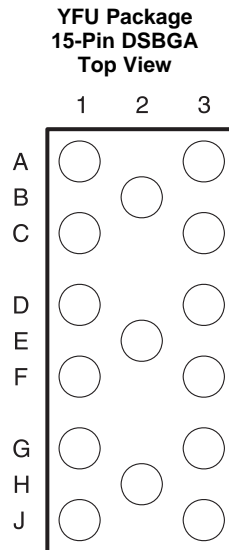

**Pin Functions — TPD6F202**

PIN		TYPE	DESCRIPTION
NO.	NAME		
A1	Ch1_In	I/O	ESD-protected channel, route to connector. Corresponds with CH1_Out.
A3	Ch1_Out	I/O	ESD-protected channel, route to system. Corresponds with CH1_In.
B2	GND	G	Ground
C1	Ch2_In	I/O	ESD-protected channel, route to connector. Corresponds with CH2_Out.
C3	Ch2_Out	I/O	ESD-protected channel, route to system. Corresponds with CH2_In.
D1	Ch3_In	I/O	ESD-protected channel, route to connector. Corresponds with CH3_Out.
D3	Ch3_Out	I/O	ESD-protected channel, route to system. Corresponds with CH3_In.
E2	GND	G	Ground
F1	Ch4_In	I/O	ESD-protected channel, route to connector. Corresponds with CH4_Out.
F3	Ch4_Out	I/O	ESD-protected channel, route to system. Corresponds with CH4_In.
G1	Ch5_In	I/O	ESD-protected channel, route to connector. Corresponds with CH5_Out.
G3	Ch5_Out	I/O	ESD-protected channel, route to system. Corresponds with CH5_In.
H2	GND	G	Ground
J1	Ch6_In	I/O	ESD-protected channel, route to connector. Corresponds with CH6_Out.
J3	Ch6_Out	I/O	ESD-protected channel, route to system. Corresponds with CH6_In.

## 6 Specifications

### 6.1 Absolute Maximum Ratings

over operating free-air temperature range (unless otherwise noted)<sup>(1)</sup>

		MIN	MAX	UNIT
V <sub>IO</sub>	IO to GND	-0.3	6	V
	Continuous power dissipation (T <sub>A</sub> = 70°C)		100	mW
T <sub>J</sub>	Junction temperature		150	°C
	Lead temperature (soldering, 10 s)		300	°C
T <sub>stg</sub>	Storage temperature	-65	150	°C

(1) Stresses beyond those listed under *Absolute Maximum Ratings* may cause permanent damage to the device. These are stress ratings only, which do not imply functional operation of the device at these or any other conditions beyond those indicated under *Recommended Operating Conditions*. Exposure to absolute-maximum-rated conditions for extended periods may affect device reliability.

## 6.2 ESD Ratings — JEDEC

			VALUE	UNIT
$V_{(ESD)}$	Electrostatic discharge	Human-body model (HBM), per ANSI/ESDA/JEDEC JS-001 <sup>(1)</sup>	±15000	V
		Charged-device model (CDM), per JEDEC specification JESD22-C101 <sup>(2)</sup>	±1500	

(1) JEDEC document JEP155 states that 500-V HBM allows safe manufacturing with a standard ESD control process.

(2) JEDEC document JEP157 states that 250-V CDM allows safe manufacturing with a standard ESD control process.

## 6.3 ESD Ratings — IEC

			VALUE	UNIT
$V_{(ESD)}$	Electrostatic discharge	IEC 61000-4-2 contact discharge	±25000	V
		IEC 61000-4-2 air-gap discharge	±25000	

## 6.4 Recommended Operating Conditions

over operating free-air temperature range (unless otherwise noted)

		MIN	MAX	UNIT
$V_{IO}$	I/O to GND	0	5.5	V
$T_A$	Ambient temperature	–40	85	°C

## 6.5 Thermal Information

THERMAL METRIC <sup>(1)</sup>		TPD4F202	TPD6F202	UNIT
		YFU (DSBGA)	YFU (DSBGA)	
		10 PINS	15 PINS	
$R_{\theta JA}$	Junction-to-ambient thermal resistance	91.8	72	°C/W
$R_{\theta JC(top)}$	Junction-to-case (top) thermal resistance	1	0.6	°C/W
$R_{\theta JB}$	Junction-to-board thermal resistance	19.7	14.1	°C/W
$\Psi_{JT}$	Junction-to-top characterization parameter	0.5	0.3	°C/W
$\Psi_{JB}$	Junction-to-board characterization parameter	19.7	14.1	°C/W
$R_{\theta JC(bot)}$	Junction-to-case (bottom) thermal resistance	n/a	n/a	°C/W

(1) For more information about traditional and new thermal metrics, see the *Semiconductor and IC Package Thermal Metrics* application report, [SPRA953](#).

## 6.6 Electrical Characteristics

$T_A = -40^\circ\text{C}$  to  $85^\circ\text{C}$  (Unless otherwise noted)

PARAMETER	TEST CONDITIONS	MIN	TYP <sup>(1)</sup>	MAX	UNIT
$V_{BR}$	DC breakdown voltage	$I_{IO} = 10 \mu\text{A}$		6	V
R	Resistance	85	100	115	$\Omega$
C	Capacitance (C1 or C2)	$V_{IO} = 3.3 \text{ V}, f = 1 \text{ MHz}$		15	pF
$I_{IO}$	Channel leakage current	$V_{IO} = 3.3 \text{ V}$		10	nA
$f_c$	Cut-off frequency	$Z_{SOURCE} = 50 \Omega, Z_{LOAD} = 50 \Omega$		108	MHz

(1) Typical values are at  $T_A = 25^\circ\text{C}$ .

## 6.7 Typical Characteristics

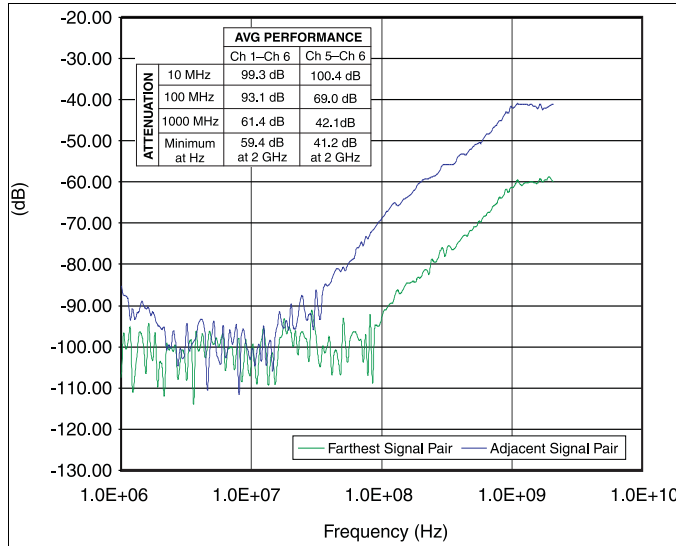

Figure 1. Channel-to-Channel Crosstalk

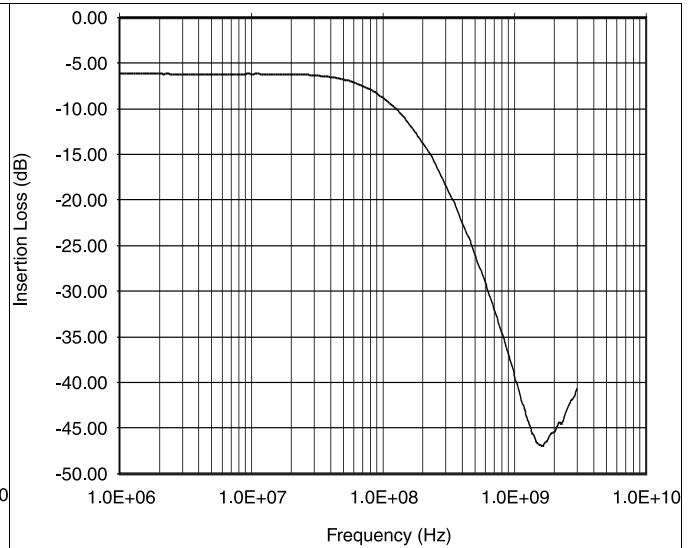

Figure 2. Frequency Response Data (0-V Bias)

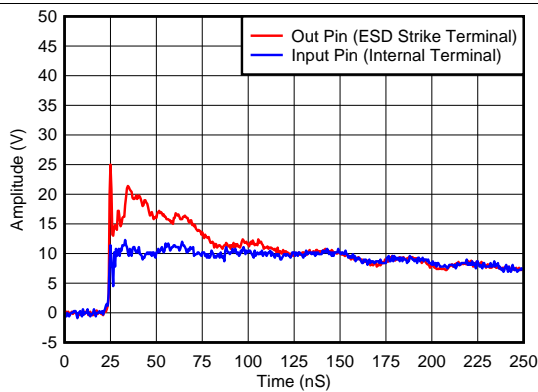

Figure 3. IEC Clamping Waveforms +8-kV Contact

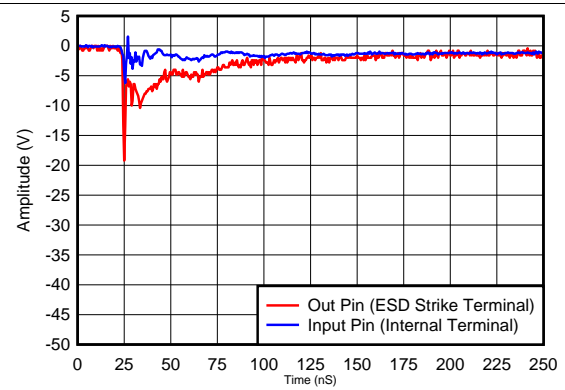

Figure 4. IEC Clamping Waveforms -8-kV Contact

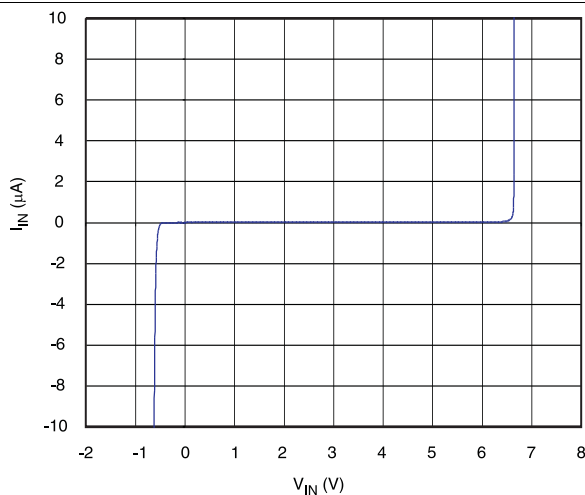

Figure 5. DC Characteristics ( $I_{IN}$  vs  $V_{IN}$ ),  $T_A = 25^\circ\text{C}$

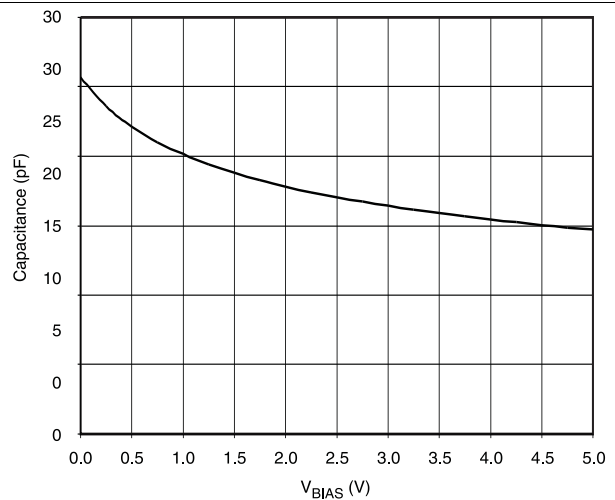

Figure 6. C1 or C2 Capacitance vs  $V_{BIAS}$

## 7 Detailed Description

### 7.1 Overview

The TPDxF202 family is a series of highly integrated devices designed to provide EMI filtering in all systems subjected to electromagnetic interference. These filters also provide a Transient Voltage Suppressor (TVS) diode circuit for ESD protection which prevents damage to the application when subjected to ESD stress far exceeding IEC 61000-4-2 (Level 4).

### 7.2 Functional Block Diagram

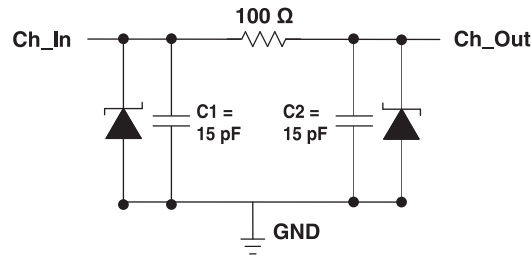

### 7.3 Feature Description

The TPDxF202 family is a line of ESD and EMI filtering devices designed to reduce EMI emissions and provide system level ESD protection. Each device can dissipate ESD strikes above the maximum level specified by IEC 61000-4-2 international standard. Additionally, the EMI filtering structure reduces EMI emissions by providing high frequency roll-off.

#### 7.3.1 Exceeds IEC61000-4-2 (Level 4) ESD Protection Requirements

The ESD protection on all pins exceeds the IEC 61000-4-2 level 4 standard. Contact and Air-Gap ESD are rated at  $\pm 25$  kV.

#### 7.3.2 Pi-Style C-R-C Filter Configuration

This family of devices has a pi-style filtering configuration composed of a series resistor and two capacitors in parallel with the I/O pins. The typical resistor value is  $100\ \Omega$  and the typical capacitor values are  $15\ \text{pF}$  each. Signal attenuation is above 40 dB at 1 GHz to 3 GHz, which provides significant reduction in spurious emissions, with a bandwidth (3-dB loss) of 108 MHz. Crosstalk is attenuated 70 dB at 100 MHz.

#### 7.3.3 Low 10-nA Leakage Current

The I/O pins feature an ultra-low leakage current of 10 nA (typical) with a bias of 3.3 V.

#### 7.3.4 Space-Saving DSBGA Package

The DSBGA package is characterized by a minimal footprint for savings in board space, fitting the design philosophy of portable devices.

##### 7.3.4.1 Flow-Through Pin Mapping

The pinout of this device makes it easy to add protection to existing board layouts. The packages offer flow-through routing which requires minimal changes to existing board layout for addition of these devices.

### 7.4 Device Functional Modes

The TPDxF202 family of devices are passive-integrated circuits that passively filter EMI and trigger when voltages are above  $V_{BR}$  or below the lower diode voltage ( $-0.6\ \text{V}$ ). During IEC 61000-4-2 ESD events, transient voltages as high as  $\pm 25$  kV can be directed to ground through the internal diode network. Once the voltages on the protected line falls below the trigger levels, the device reverts to passive.

## 8 Application and Implementation

### NOTE

Information in the following applications sections is not part of the TI component specification, and TI does not warrant its accuracy or completeness. TI's customers are responsible for determining suitability of components for their purposes. Customers should validate and test their design implementation to confirm system functionality.

### 8.1 Application Information

The TPDxF202 family are diode-type TVSs integrated with series resistors and parallel capacitors for filtering emitted EMI. As a signal passes through the device, higher frequency components are filtered out. This device also provides a path to ground during ESD events and isolates the protected IC. As the current from ESD passes through the TVS, only a small voltage drop is present across the diode. This is the voltage presented to the protected IC. In particular, these filters are ideal for EMI filtering and protecting data lines from ESD at display, keypad, and memory interfaces.

### 8.2 Typical Application

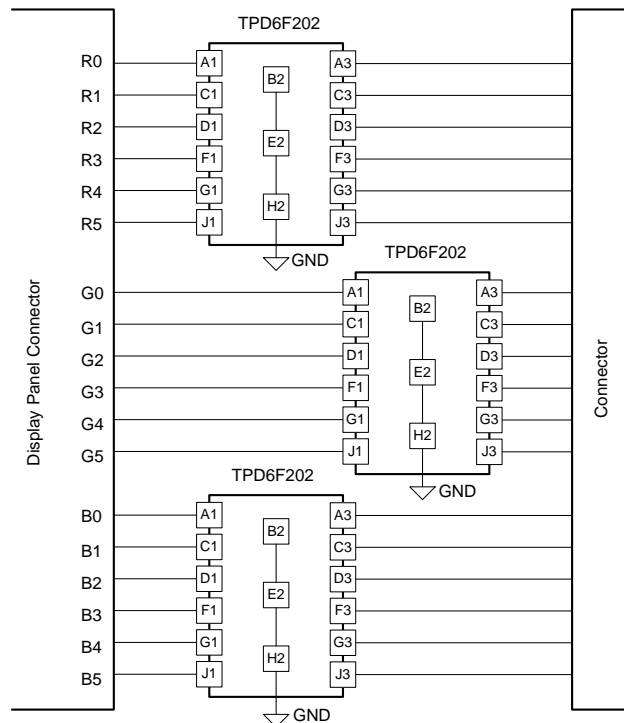

**Figure 7. Display Panel Schematic**

#### 8.2.1 Design Requirements

For this design example, three TPD6F202 devices are used in an 18-bit display panel application. This application provides a complete ESD and EMI protection solution for the display connector. For the display panel application, the following parameters are shown in [Table 1](#).

**Table 1. Design Parameters**

DESIGN PARAMETER	VALUE
Signal range on all pins except GND	0 V to 5 V
Data Rate	200 Mbps
ESD Protection Level	IEC 61000-4-2 Level 4



### 8.2.2 Detailed Design Procedure

To begin the design process, some design parameters must be decided; the designer needs to know the operating frequency and the signal range on all the protected lines.

#### 8.2.2.1 Signal Range on All Protected Lines

The TPD6F202 has 6 identical protection channels for signal lines. All I/O pins will support a signal range from 0 to 5.5 V.

#### 8.2.2.2 Data Rate

The TPD6F202 has a 108-MHz, –3-dB bandwidth, which supports the data rate for this display.

#### 8.2.2.3 ESD Protection Level

The contact and air-gap ratings of  $\pm 25$  kV for TPD6F202 exceeds the IEC 61000-4-2 Level 4 rating of  $\pm 8$ -kV contact and  $\pm 15$ -kV air-gap ratings.

### 8.2.3 Application Curve

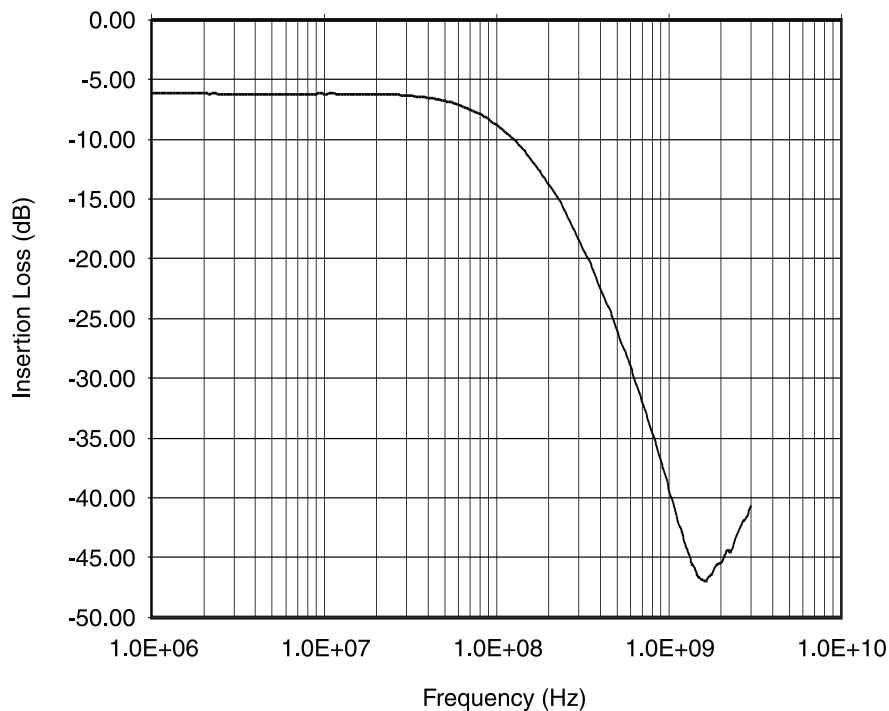

**Figure 8. Frequency Response Data (0-V Bias)**

## 9 Power Supply Recommendations

The TPDxF202 device is a passive ESD-protection device, and therefore, does not require a power supply. Take care to avoid violating the maximum-voltage specification to ensure that the device functions properly. The IO lines can tolerate up to 6-V DC.

## 10 Layout

### 10.1 Layout Guidelines

Typically, there are multiple EMI filters being used in portable applications to suppress the EMI interference. This means the total board area consumed by EMI filters are relatively large. One example of space-saving innovation is to place the EMI filters right under the connectors so that the main PCB space is not used. The YFU packages of the TPDxF202 series offer ultra low-profile package height which enables such innovative component placement in portable applications. Package under-fill is recommended while using the YFU packages in flex boards.

- The optimum placement is as close to the connector as possible.
  - EMI during an ESD event can couple from the trace being struck to other nearby unprotected traces, resulting in early system failures.
  - The PCB designer needs to minimize the possibility of EMI coupling by keeping any unprotected traces away from the protected traces which are between the TVS and the connector.
- Route the protected traces as straight as possible.
- Eliminate any sharp corners on the protected traces between the TVS and the connector by using rounded corners with the largest radii possible.
  - Electric fields tend to build up on corners, increasing EMI coupling.

For maximum efficiency of filtering and ESD protection, while doing the board layout, take care to reduce board parasitic series inductances from package GND pins to board GND plane. The TPDxF202 devices must be connected to a ground plane with a micro via adjacent to the device GND pad. If this is not possible, the connection to the ground plane must be as direct as possible to minimize the inductance. Due to flow-through pin mapping, the signal pins routing is easily achieved in a single layer.

### 10.2 Layout Example

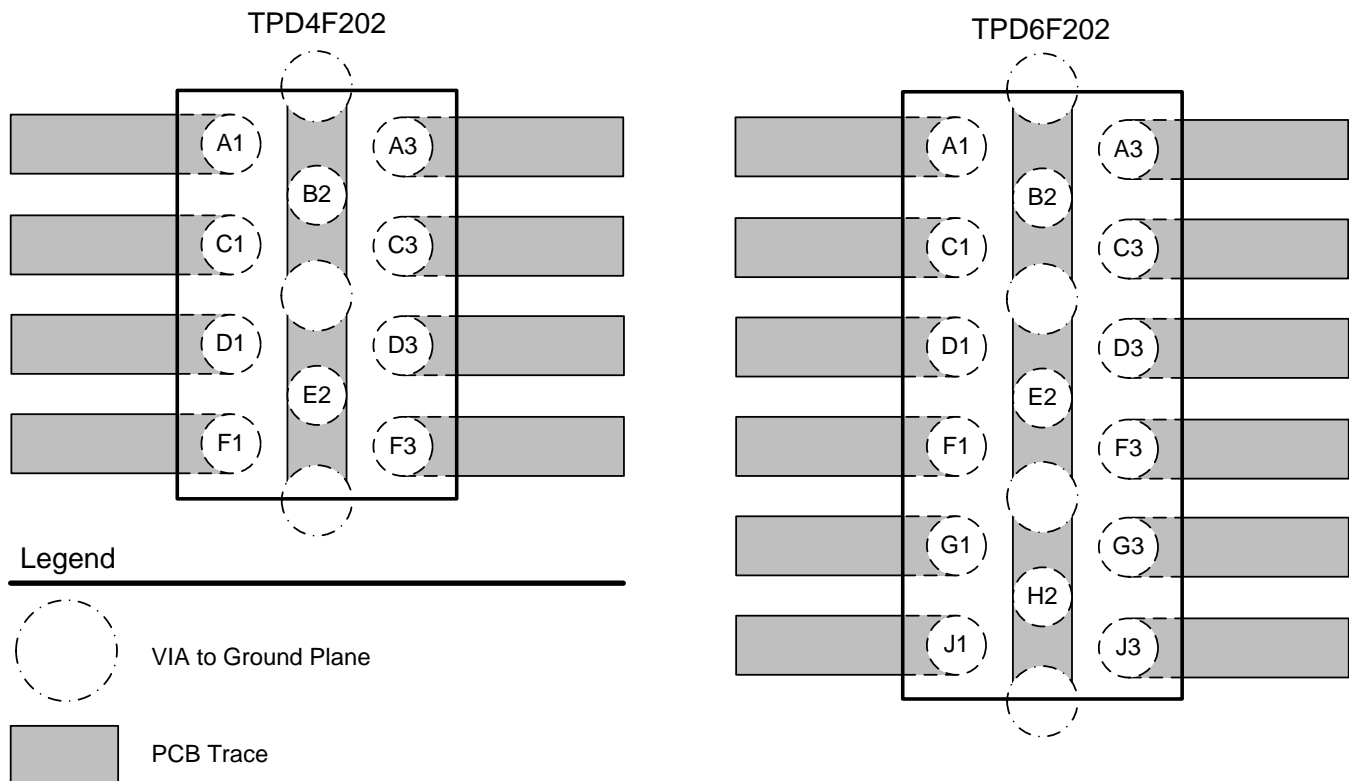

**Figure 9. Board Layout With TPDxF202**

## 11 Device and Documentation Support

### 11.1 Documentation Support

#### 11.1.1 Related Documentation

The following documents contain additional information related to the use of the TPDxF202 device:

- *ESD Protection Layout Guide*, [SLVA680](#)
- *Reading and Understanding an ESD Protection Datasheet*, [SLLA305](#)

### 11.2 Related Links

The table below lists quick access links. Categories include technical documents, support and community resources, tools and software, and quick access to sample or buy.

**Table 2. Related Links**

PARTS	PRODUCT FOLDER	SAMPLE & BUY	TECHNICAL DOCUMENTS	TOOLS & SOFTWARE	SUPPORT & COMMUNITY
TPD4F202	<a href="#">Click here</a>	<a href="#">Click here</a>	<a href="#">Click here</a>	<a href="#">Click here</a>	<a href="#">Click here</a>
TPD6F202	<a href="#">Click here</a>	<a href="#">Click here</a>	<a href="#">Click here</a>	<a href="#">Click here</a>	<a href="#">Click here</a>

### 11.3 Community Resources

The following links connect to TI community resources. Linked contents are provided "AS IS" by the respective contributors. They do not constitute TI specifications and do not necessarily reflect TI's views; see TI's [Terms of Use](#).

**TI E2E™ Online Community** *TI's Engineer-to-Engineer (E2E) Community*. Created to foster collaboration among engineers. At [e2e.ti.com](http://e2e.ti.com), you can ask questions, share knowledge, explore ideas and help solve problems with fellow engineers.

**Design Support** *TI's Design Support* Quickly find helpful E2E forums along with design support tools and contact information for technical support.

### 11.4 Trademarks

E2E is a trademark of Texas Instruments.  
All other trademarks are the property of their respective owners.

### 11.5 Electrostatic Discharge Caution



These devices have limited built-in ESD protection. The leads should be shorted together or the device placed in conductive foam during storage or handling to prevent electrostatic damage to the MOS gates.

### 11.6 Glossary

[SLYZ022](#) — *TI Glossary*.

This glossary lists and explains terms, acronyms, and definitions.

## 12 Mechanical, Packaging, and Orderable Information

The following pages include mechanical, packaging, and orderable information. This information is the most current data available for the designated devices. This data is subject to change without notice and revision of this document. For browser-based versions of this data sheet, refer to the left-hand navigation.

**PACKAGING INFORMATION**

Orderable Device	Status (1)	Package Type	Package Drawing	Pins	Package Qty	Eco Plan (2)	Lead/Ball Finish (6)	MSL Peak Temp (3)	Op Temp (°C)	Device Marking (4/5)	Samples
TPD4F202YFUR	ACTIVE	DSBGA	YFU	10	3000	Green (RoHS & no Sb/Br)	SNAGCU	Level-1-260C-UNLIM	-40 to 85	57S	<a href="#">Samples</a>
TPD6F202YFUR	ACTIVE	DSBGA	YFU	15	3000	Green (RoHS & no Sb/Br)	SNAGCU	Level-1-260C-UNLIM	-40 to 85	5WS	<a href="#">Samples</a>

(1) The marketing status values are defined as follows:

**ACTIVE:** Product device recommended for new designs.

**LIFEBUY:** TI has announced that the device will be discontinued, and a lifetime-buy period is in effect.

**NRND:** Not recommended for new designs. Device is in production to support existing customers, but TI does not recommend using this part in a new design.

**PREVIEW:** Device has been announced but is not in production. Samples may or may not be available.

**OBSOLETE:** TI has discontinued the production of the device.

(2) Eco Plan - The planned eco-friendly classification: Pb-Free (RoHS), Pb-Free (RoHS Exempt), or Green (RoHS & no Sb/Br) - please check <http://www.ti.com/productcontent> for the latest availability information and additional product content details.

**TBD:** The Pb-Free/Green conversion plan has not been defined.

**Pb-Free (RoHS):** TI's terms "Lead-Free" or "Pb-Free" mean semiconductor products that are compatible with the current RoHS requirements for all 6 substances, including the requirement that lead not exceed 0.1% by weight in homogeneous materials. Where designed to be soldered at high temperatures, TI Pb-Free products are suitable for use in specified lead-free processes.

**Pb-Free (RoHS Exempt):** This component has a RoHS exemption for either 1) lead-based flip-chip solder bumps used between the die and package, or 2) lead-based die adhesive used between the die and leadframe. The component is otherwise considered Pb-Free (RoHS compatible) as defined above.

**Green (RoHS & no Sb/Br):** TI defines "Green" to mean Pb-Free (RoHS compatible), and free of Bromine (Br) and Antimony (Sb) based flame retardants (Br or Sb do not exceed 0.1% by weight in homogeneous material)

(3) MSL, Peak Temp. - The Moisture Sensitivity Level rating according to the JEDEC industry standard classifications, and peak solder temperature.

(4) There may be additional marking, which relates to the logo, the lot trace code information, or the environmental category on the device.

(5) Multiple Device Markings will be inside parentheses. Only one Device Marking contained in parentheses and separated by a "~" will appear on a device. If a line is indented then it is a continuation of the previous line and the two combined represent the entire Device Marking for that device.

(6) Lead/Ball Finish - Orderable Devices may have multiple material finish options. Finish options are separated by a vertical ruled line. Lead/Ball Finish values may wrap to two lines if the finish value exceeds the maximum column width.

**Important Information and Disclaimer:** The information provided on this page represents TI's knowledge and belief as of the date that it is provided. TI bases its knowledge and belief on information provided by third parties, and makes no representation or warranty as to the accuracy of such information. Efforts are underway to better integrate information from third parties. TI has taken and continues to take reasonable steps to provide representative and accurate information but may not have conducted destructive testing or chemical analysis on incoming materials and chemicals. TI and TI suppliers consider certain information to be proprietary, and thus CAS numbers and other limited information may not be available for release.

In no event shall TI's liability arising out of such information exceed the total purchase price of the TI part(s) at issue in this document sold by TI to Customer on an annual basis.

## TAPE AND REEL INFORMATION



### QUADRANT ASSIGNMENTS FOR PIN 1 ORIENTATION IN TAPE



\*All dimensions are nominal

Device	Package Type	Package Drawing	Pins	SPQ	Reel Diameter (mm)	Reel Width W1 (mm)	A0 (mm)	B0 (mm)	K0 (mm)	P1 (mm)	W (mm)	Pin1 Quadrant
TPD4F202YFUR	DSBGA	YFU	10	3000	178.0	9.2	1.21	1.72	0.45	4.0	8.0	Q1
TPD6F202YFUR	DSBGA	YFU	15	3000	178.0	9.2	1.19	2.5	0.45	4.0	8.0	Q1

**TAPE AND REEL BOX DIMENSIONS**

\*All dimensions are nominal

Device	Package Type	Package Drawing	Pins	SPQ	Length (mm)	Width (mm)	Height (mm)
TPD4F202YFUR	DSBGA	YFU	10	3000	220.0	220.0	35.0
TPD6F202YFUR	DSBGA	YFU	15	3000	220.0	220.0	35.0

YFU (R-XBGA-N10)

DIE-SIZE BALL GRID ARRAY

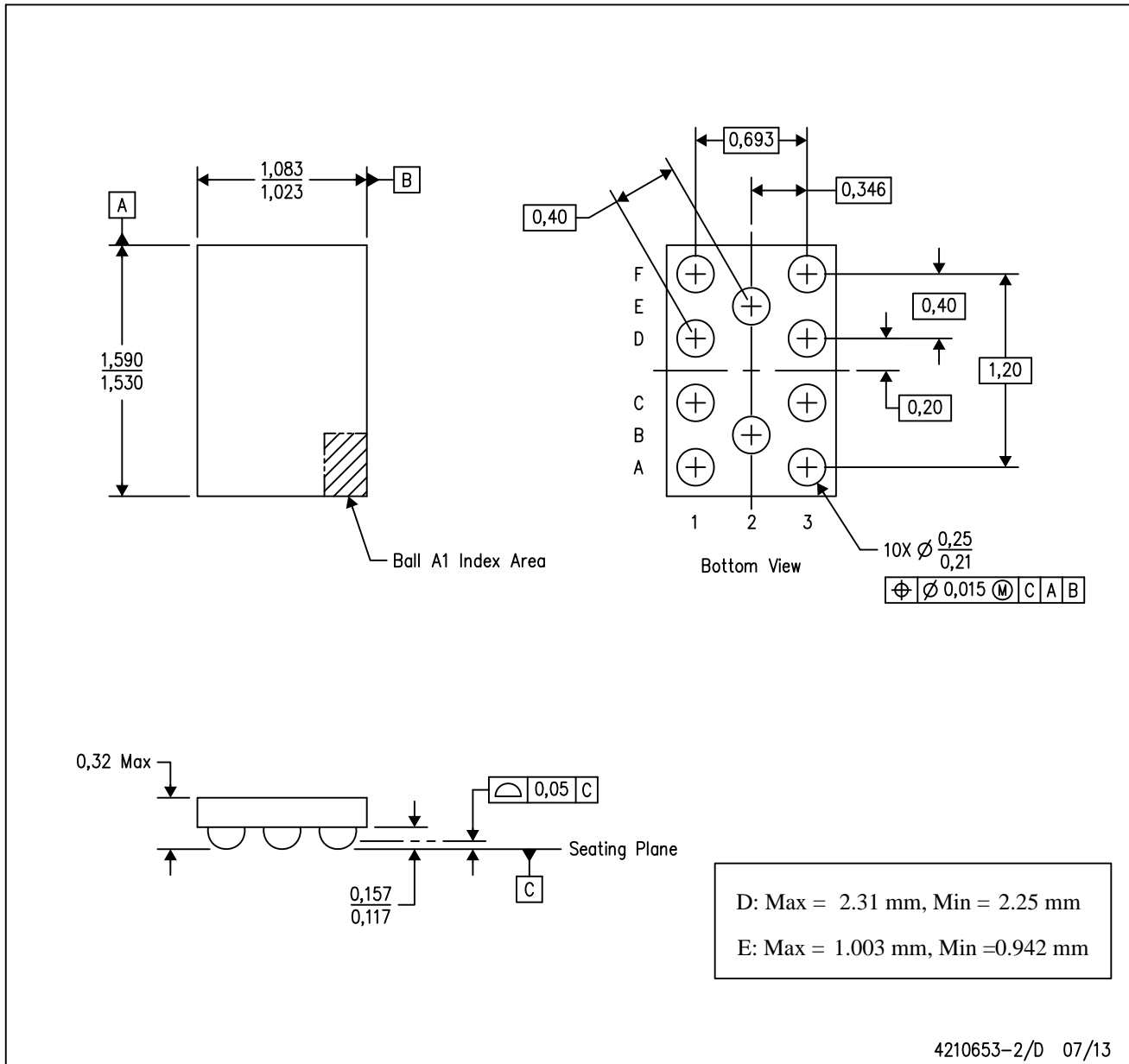

- NOTES:
- A. All linear dimensions are in millimeters. Dimensioning and tolerancing per ASME Y14.5M-1994.
  - B. This drawing is subject to change without notice.
  - C. NanoFree™ package configuration.

NanoFree is a trademark of Texas Instruments.



YFU (R-XBGA-N15)

DIE-SIZE BALL GRID ARRAY

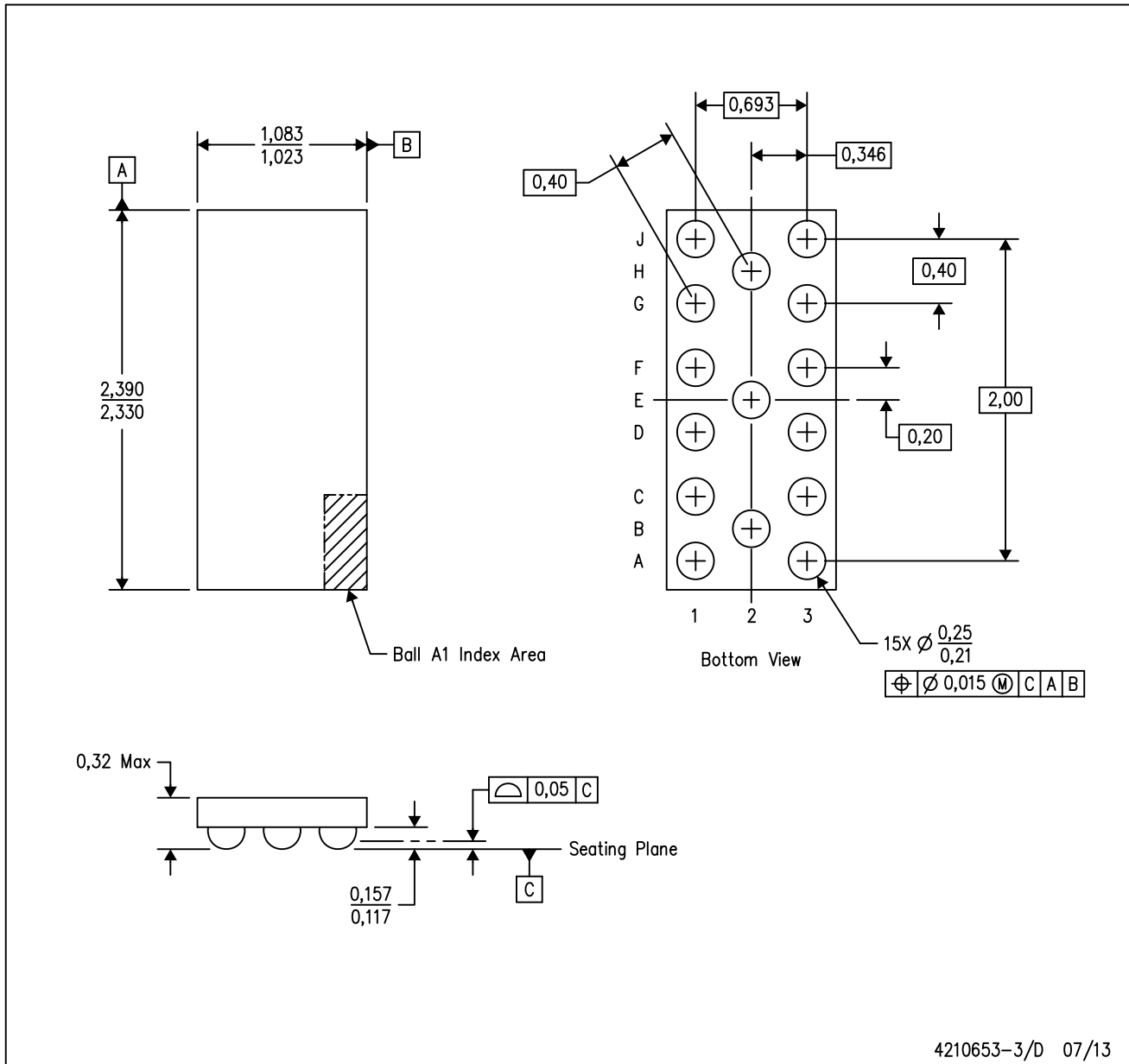

4210653-3/D 07/13

- NOTES:
- A. All linear dimensions are in millimeters. Dimensioning and tolerancing per ASME Y14.5M-1994.
  - B. This drawing is subject to change without notice.
  - C. NanoFree™ package configuration.

NanoFree is a trademark of Texas Instruments.

## IMPORTANT NOTICE

Texas Instruments Incorporated (TI) reserves the right to make corrections, enhancements, improvements and other changes to its semiconductor products and services per JESD46, latest issue, and to discontinue any product or service per JESD48, latest issue. Buyers should obtain the latest relevant information before placing orders and should verify that such information is current and complete.

TI's published terms of sale for semiconductor products (<http://www.ti.com/sc/docs/stdterms.htm>) apply to the sale of packaged integrated circuit products that TI has qualified and released to market. Additional terms may apply to the use or sale of other types of TI products and services.

Reproduction of significant portions of TI information in TI data sheets is permissible only if reproduction is without alteration and is accompanied by all associated warranties, conditions, limitations, and notices. TI is not responsible or liable for such reproduced documentation. Information of third parties may be subject to additional restrictions. Resale of TI products or services with statements different from or beyond the parameters stated by TI for that product or service voids all express and any implied warranties for the associated TI product or service and is an unfair and deceptive business practice. TI is not responsible or liable for any such statements.

Buyers and others who are developing systems that incorporate TI products (collectively, "Designers") understand and agree that Designers remain responsible for using their independent analysis, evaluation and judgment in designing their applications and that Designers have full and exclusive responsibility to assure the safety of Designers' applications and compliance of their applications (and of all TI products used in or for Designers' applications) with all applicable regulations, laws and other applicable requirements. Designer represents that, with respect to their applications, Designer has all the necessary expertise to create and implement safeguards that (1) anticipate dangerous consequences of failures, (2) monitor failures and their consequences, and (3) lessen the likelihood of failures that might cause harm and take appropriate actions. Designer agrees that prior to using or distributing any applications that include TI products, Designer will thoroughly test such applications and the functionality of such TI products as used in such applications.

TI's provision of technical, application or other design advice, quality characterization, reliability data or other services or information, including, but not limited to, reference designs and materials relating to evaluation modules, (collectively, "TI Resources") are intended to assist designers who are developing applications that incorporate TI products; by downloading, accessing or using TI Resources in any way, Designer (individually or, if Designer is acting on behalf of a company, Designer's company) agrees to use any particular TI Resource solely for this purpose and subject to the terms of this Notice.

TI's provision of TI Resources does not expand or otherwise alter TI's applicable published warranties or warranty disclaimers for TI products, and no additional obligations or liabilities arise from TI providing such TI Resources. TI reserves the right to make corrections, enhancements, improvements and other changes to its TI Resources. TI has not conducted any testing other than that specifically described in the published documentation for a particular TI Resource.

Designer is authorized to use, copy and modify any individual TI Resource only in connection with the development of applications that include the TI product(s) identified in such TI Resource. NO OTHER LICENSE, EXPRESS OR IMPLIED, BY ESTOPPEL OR OTHERWISE TO ANY OTHER TI INTELLECTUAL PROPERTY RIGHT, AND NO LICENSE TO ANY TECHNOLOGY OR INTELLECTUAL PROPERTY RIGHT OF TI OR ANY THIRD PARTY IS GRANTED HEREIN, including but not limited to any patent right, copyright, mask work right, or other intellectual property right relating to any combination, machine, or process in which TI products or services are used. Information regarding or referencing third-party products or services does not constitute a license to use such products or services, or a warranty or endorsement thereof. Use of TI Resources may require a license from a third party under the patents or other intellectual property of the third party, or a license from TI under the patents or other intellectual property of TI.

TI RESOURCES ARE PROVIDED "AS IS" AND WITH ALL FAULTS. TI DISCLAIMS ALL OTHER WARRANTIES OR REPRESENTATIONS, EXPRESS OR IMPLIED, REGARDING RESOURCES OR USE THEREOF, INCLUDING BUT NOT LIMITED TO ACCURACY OR COMPLETENESS, TITLE, ANY EPIDEMIC FAILURE WARRANTY AND ANY IMPLIED WARRANTIES OF MERCHANTABILITY, FITNESS FOR A PARTICULAR PURPOSE, AND NON-INFRINGEMENT OF ANY THIRD PARTY INTELLECTUAL PROPERTY RIGHTS. TI SHALL NOT BE LIABLE FOR AND SHALL NOT DEFEND OR INDEMNIFY DESIGNER AGAINST ANY CLAIM, INCLUDING BUT NOT LIMITED TO ANY INFRINGEMENT CLAIM THAT RELATES TO OR IS BASED ON ANY COMBINATION OF PRODUCTS EVEN IF DESCRIBED IN TI RESOURCES OR OTHERWISE. IN NO EVENT SHALL TI BE LIABLE FOR ANY ACTUAL, DIRECT, SPECIAL, COLLATERAL, INDIRECT, PUNITIVE, INCIDENTAL, CONSEQUENTIAL OR EXEMPLARY DAMAGES IN CONNECTION WITH OR ARISING OUT OF TI RESOURCES OR USE THEREOF, AND REGARDLESS OF WHETHER TI HAS BEEN ADVISED OF THE POSSIBILITY OF SUCH DAMAGES.

Unless TI has explicitly designated an individual product as meeting the requirements of a particular industry standard (e.g., ISO/TS 16949 and ISO 26262), TI is not responsible for any failure to meet such industry standard requirements.

Where TI specifically promotes products as facilitating functional safety or as compliant with industry functional safety standards, such products are intended to help enable customers to design and create their own applications that meet applicable functional safety standards and requirements. Using products in an application does not by itself establish any safety features in the application. Designers must ensure compliance with safety-related requirements and standards applicable to their applications. Designer may not use any TI products in life-critical medical equipment unless authorized officers of the parties have executed a special contract specifically governing such use. Life-critical medical equipment is medical equipment where failure of such equipment would cause serious bodily injury or death (e.g., life support, pacemakers, defibrillators, heart pumps, neurostimulators, and implantables). Such equipment includes, without limitation, all medical devices identified by the U.S. Food and Drug Administration as Class III devices and equivalent classifications outside the U.S.

TI may expressly designate certain products as completing a particular qualification (e.g., Q100, Military Grade, or Enhanced Product). Designers agree that it has the necessary expertise to select the product with the appropriate qualification designation for their applications and that proper product selection is at Designers' own risk. Designers are solely responsible for compliance with all legal and regulatory requirements in connection with such selection.

Designer will fully indemnify TI and its representatives against any damages, costs, losses, and/or liabilities arising out of Designer's non-compliance with the terms and provisions of this Notice.