

- Low Voltage Operation . . . 2.5 V to 7 V
- Low Power . . . 3.5 mA  
(f = 500 kHz, Duty = 50%)
- Internal Undervoltage Lockout Protection
- Internal Short Circuit Protection
- Wide Operating Frequency . . . 50 kHz to 1 MHz
- Internal Precision Reference . . . 1.25 V ±1% (25°C)
- On/Off Switch for CH1/3 Pair and Ch2 (see Function Table)
- 0 to 100% Dead Time Control
- Totem Pole Output Stage
- Small Package . . . 16 Pin TSSOP

PW PACKAGE  
(TOP VIEW)

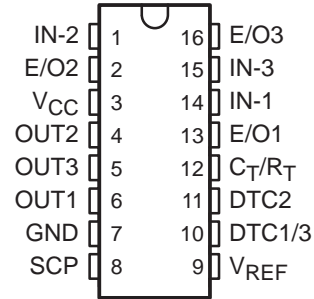

## description

The TPS5100 is a triple PWM control circuit, primarily designed to compose the power supply for LCD display. Each PWM channel has own error amplifier, PWM comparator, dead-time control and output driver. The trimmed voltage reference, oscillator, undervoltage lockout and short circuit protection are common for all channels.

This device includes two boost exclusive circuits (ch1,3) and a buck-boost exclusive circuit (ch2). The operating frequency is set with external resistor and capacitor, and dead time is continuously adjustable from 0% to 100% duty cycle with resistive divider network. Soft start function can be implemented by adding a capacitor to dead time divider network. Two dead time control inputs are assigned for ch1,3 pair and ch2 individually and each dead time control input can be used to control on/off operation. TPS5100 can operate from 2.5 V supply voltage and ch1,3 pair and ch2 operate with reverse phase switching each other to achieve efficient operation in low power and battery powered system.

The TPS5100 is characterized for operation from -20°C to 85°C.

FUNCTION TABLE

CONDITION	OUTPUT		
	CH-1	CH-2	CH-3
DTC1/3 > 0.3 V, DTC2 > 0.3 V	ON H	ON L	ON H
DTC1/3 > 0.3 V, DTC2 < 0.2 V	ON H	OFF H	ON H
DTC1/3 < 0.2 V, DTC2 > 0.3 V	OFF L	ON L	OFF L
DTC1/3 < 0.2 V, DTC2 < 0.2 V	OFF L	OFF H	OFF L

AVAILABLE OPTIONS

T <sub>A</sub>	PACKAGE
	TSSOP (PW)
-20°C to 85°C	TPS5100PW



Please be aware that an important notice concerning availability, standard warranty, and use in critical applications of Texas Instruments semiconductor products and disclaimers thereto appears at the end of this data sheet.

# TPS5100 TRIPLE-CHANNEL PWM CONTROL CIRCUITS

SLVS169 – JANUARY 2000

## functional block diagram

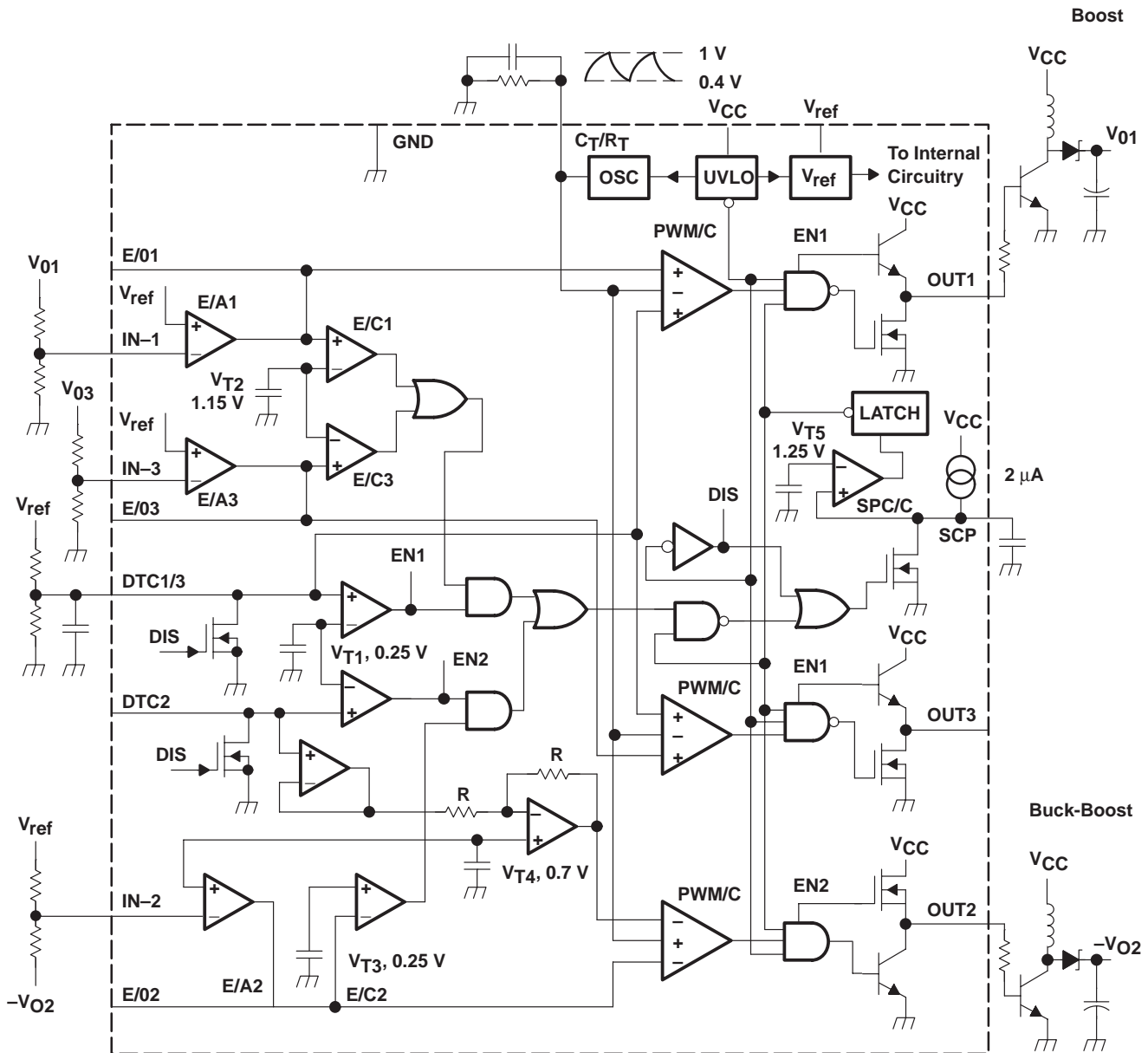

NOTE A: All voltages and currents listed are nominal.

**electrical characteristics over recommended operating free-air temperature range,  $V_{CC} = 3.3\text{ V}$  (unless otherwise noted) (see Note 1)**

PARAMETER		TEST CONDITIONS	MIN	TYP	MAX	UNIT
$V_{REF}$	Reference voltage	$I_{REF} = -1\text{ mA}$ , $T_A = 25^\circ\text{C}$	1.237	1.250	1.263	V
$V_{REF(dev)}$	Reference voltage change with $T_A$	$I_{REF} = -1\text{ mA}$ , See Note 2		15	25	mV
REGIN	Input regulation	$I_{REF} = -1\text{ mA}$ , $V_{CC} = 2.5\text{ V to }7\text{ V}$		2	5	mV
REGL	Output regulation	$I_{REF} = -0.1\text{ mA to }-1\text{ mA}$		1	5	mV
$I_{OS}$	Short-circuit output current	$V_{REF} = 0$	-2	-10	-30	mA

NOTES: 1. Typical values of all parameters except for  $V_{REF(dev)}$  and  $f_{dT}$  are specified at  $T_A = 25^\circ\text{C}$ .  
2. The deviation parameter  $V_{REF(dev)}$  is defined as the difference between the maximum and minimum values obtained over the recommended free-air temperature range ( $-20^\circ\text{C}$  to  $85^\circ\text{C}$ ).

### undervoltage lockout section

PARAMETER		TEST CONDITIONS	MIN	TYP	MAX	UNIT
$V_{TH}$	Upper threshold voltage	$T_A = 25^\circ\text{C}$	2.2	2.3	2.4	V
$V_{TL}$	Lower threshold voltage	$T_A = 25^\circ\text{C}$	2	2.1	2.2	V
$V_{hys}$	Hysteresis ( $V_{TH} - V_{TL}$ )	$T_A = 25^\circ\text{C}$	0.1	0.2	0.3	V

NOTE 1: Typical values of all parameters except for  $V_{REF(dev)}$  and  $f_{dT}$  are specified at  $T_A = 25^\circ\text{C}$ .

### protection control section

PARAMETER		TEST CONDITIONS	MIN	TYP	MAX	UNIT
$I_{SCP}$	Input terminal source current		-1.4	-2	-2.6	$\mu\text{A}$
$V_{T2}$	Input threshold voltage	CH-1, 3	1.10	1.15	1.20	V
$V_{T3}$		CH-2	0.20	0.25	0.30	
$V_R$	Latch reset threshold voltage	$T_A = 25^\circ\text{C}$	0.8	1.5		V
$V_{T5}$	Threshold voltage		1.20	1.25	1.30	V

NOTE 1: Typical values of all parameters except for  $V_{REF(dev)}$  and  $f_{dT}$  are specified at  $T_A = 25^\circ\text{C}$ .

### oscillator section

PARAMETER		TEST CONDITIONS	MIN	TYP	MAX	UNIT
$f_{OSC}$	Frequency	$C_T = 130\text{ pF}$ , $R_T = 7\text{ k}\Omega$	400	500	600	kHz
$f_{dV}$	Frequency change with $V_{CC}$	$V_{CC} = 2.5\text{ V}$ , $T_A = 25^\circ\text{C}$ , $C_T = 130\text{ pF}$ , $R_T = 7\text{ k}\Omega$		1%	2%	
$f_{dT}$	Frequency change with $T_A$	$C_T = 130\text{ pF}$ , $R_T = 7\text{ k}\Omega$		5%	10%	
$I_{CT/RT}$	Output source current		-180	-200	-220	$\mu\text{A}$
$V_{OSCH}$	H level output voltage		0.95	1	1.05	V
$V_{OSCL}$	L level output voltage		0.35	0.40	0.45	V

NOTE 1: Typical values of all parameters except for  $V_{REF(dev)}$  and  $f_{dT}$  are specified at  $T_A = 25^\circ\text{C}$ .

### dead time control section

PARAMETER		TEST CONDITIONS	MIN	TYP	MAX	UNIT
$I_{BDT1/3}$	Input bias current	$V_{DTC1/3} = 0.35\text{ V to }1.05\text{ V}$			200	nA
$I_{BDT2}$		$V_{DTC2} = 0.35\text{ V to }1.05\text{ V}$		$\pm 2$	$\pm 20$	
$V_{T1}$	Comparator threshold voltage		0.2	0.25	0.3	V
$V_{T0(DTC1/3)}$	Input threshold voltage (DTC1/3) (see Note 3)	Duty = 0%	0.3	0.4	0.5	V
$V_{T100(DTC1/3)}$		Duty = 100%				
$V_{T0(DTC2)}$	Input threshold voltage (DTC2) (see Note 3)	Duty = 0%	0.3	0.4	0.5	V
$V_{T100(DTC2)}$		Duty = 100%				

NOTES: 1. Typical values of all parameters except for  $V_{REF(dev)}$  and  $f_{dT}$  are specified at  $T_A = 25^\circ\text{C}$ .  
3. These specifications are not production tested. They are specified as ensured values on circuit design.

# TPS5100

## TRIPLE-CHANNEL PWM CONTROL CIRCUITS

SLVS169 – JANUARY 2000

electrical characteristics over recommended operating free-air temperature range,  $V_{CC} = 3.3\text{ V}$  (unless otherwise noted) (see Note 1) (continued)

### error amplifier section

PARAMETER		TEST CONDITIONS		MIN	TYP	MAX	UNIT
$V_{IO}$	Input offset voltage	CH1, 3,	$A_V = 1$			15	mV
$I_{IB}$	Input bias current	CH1, 3,	$V_I = -.95\text{ V to }1.55\text{ V}$		$\pm 10$	$\pm 20$	nA
		CH2,	$V_I = 0.4\text{ V to }1\text{ V}$		$\pm 10$	$\pm 20$	
$V_{IR}$	Input voltage range	CH1, 3,		0.95		1.55	V
		CH2		0.4		1	
$A_{VD}$	Open-loop voltage amplification	$R_{FB} = 200\text{ k}\Omega$			60		dB
$B_1$	Unity-gain bandwidth				1		MHz
$V_{OM+}$	Output voltage swing	$V_{ID} = 0.1\text{ V}$	$I_O = 60\text{ }\mu\text{A}$	1.2			V
$V_{OM-}$			$I_O = 0.2\text{ mA}$	0.2			
$I_{OM+}$	Output sink current	$V_{ID} = 0.1\text{ V}$ ,	$V_O = 0.2\text{ V}$	0.2	1		mA
$I_{OM-}$	Output source current	$V_{ID} = 0.1\text{ V}$ ,	$V_O = 1.2\text{ V}$	-60	-100		$\mu\text{A}$
$V_{T4}$	Input bias voltage	CH2,	$A_V = 1$ , $T_A = 25^\circ\text{C}$	678	700	722	mV
		CH2,	$A_V = 1$	665	700	735	

NOTE 1: Typical values of all parameters except for  $V_{REF(dev)}$  and  $f_{dT}$  are specified at  $T_A = 25^\circ\text{C}$ .

### output section

PARAMETER		TEST CONDITIONS		MIN	TYP	MAX	UNIT
$V_{OH}$	High-level output voltage	$I_O = 20\text{ mA (CH2)}$		2.9	3.05		V
		$I_O = -40\text{ mA (CH1, 3)}$		1.9	2.2	2.6	
$V_{OL}$	Low-level output voltage	$I_O = 20\text{ mA (CH1, 3)}$			0.2	0.4	V
		$I_O = 40\text{ mA (CH2)}$		0.2	0.3	0.6	
$t_r$	Rise time	$CL = 1000\text{ pF}$			130		ns
$t_f$	Fall time	$I_O = 1000\text{ pF}$			50		ns

NOTE 1: Typical values of all parameters except for  $V_{REF(dev)}$  and  $f_{dT}$  are specified at  $T_A = 25^\circ\text{C}$ .

### total device

PARAMETER		TEST CONDITIONS		MIN	TYP	MAX	UNIT
$I_{CC}$	Supply current	Output OFF state			2.5	4	mA
$I_{CCA}$	Average supply current	$F_{OSC} = 500\text{ kHz}$ , Duty = 50%, No load			3.5	5	mA

NOTE 1: Typical values of all parameters except for  $V_{REF(dev)}$  and  $f_{dT}$  are specified at  $T_A = 25^\circ\text{C}$ .



TYPICAL CHARACTERISTICS

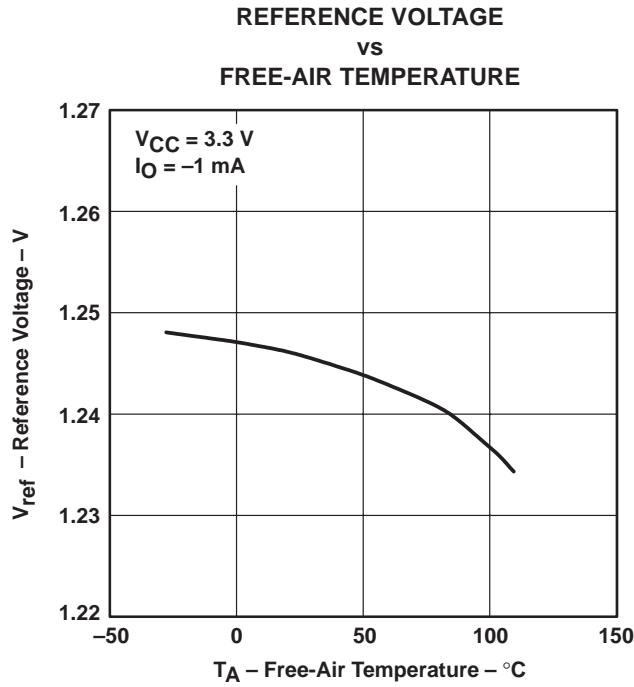

Figure 1

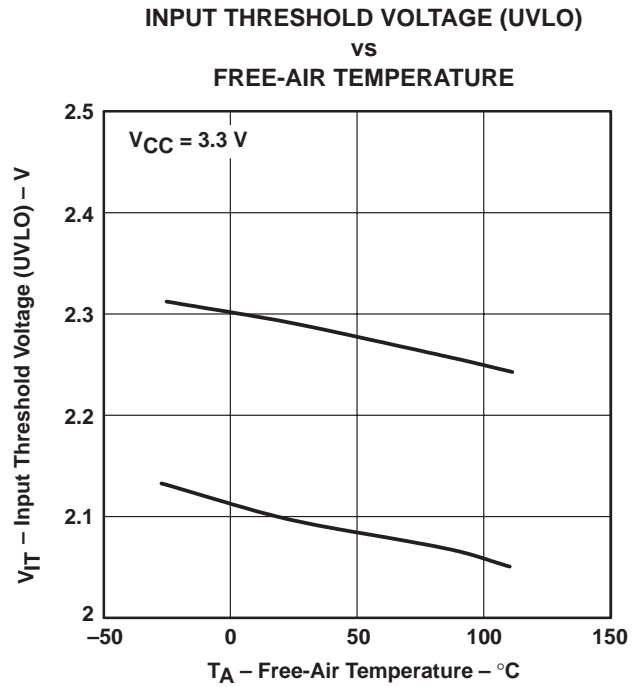

Figure 2

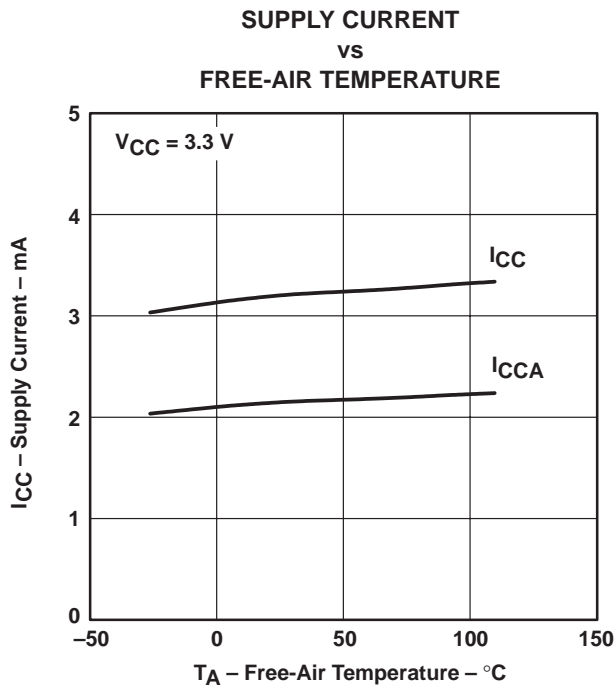

Figure 3

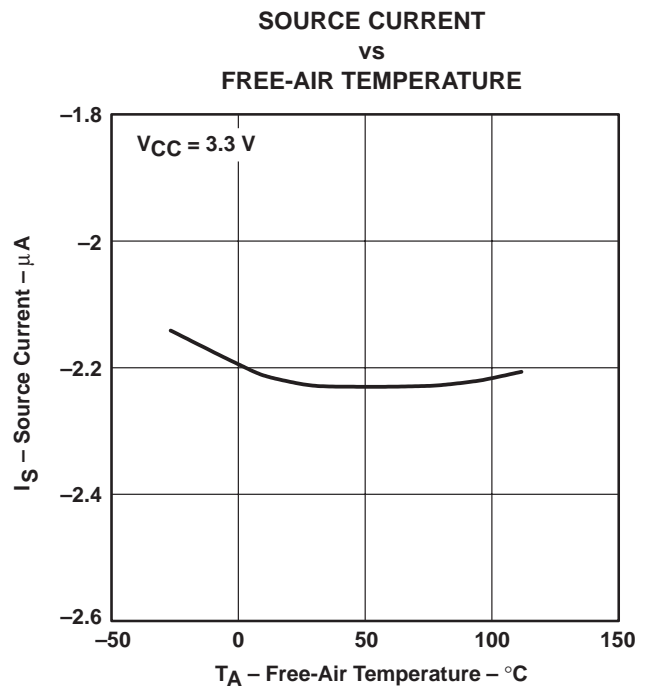

Figure 4

TYPICAL CHARACTERISTICS

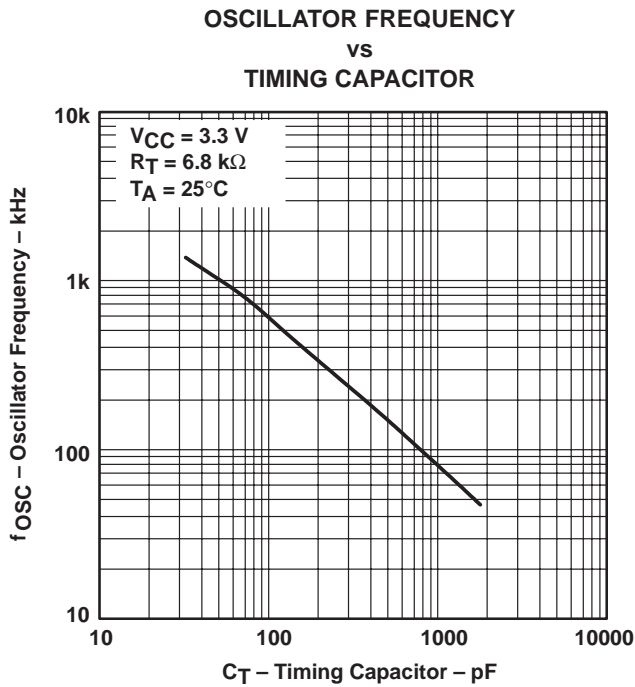

Figure 5

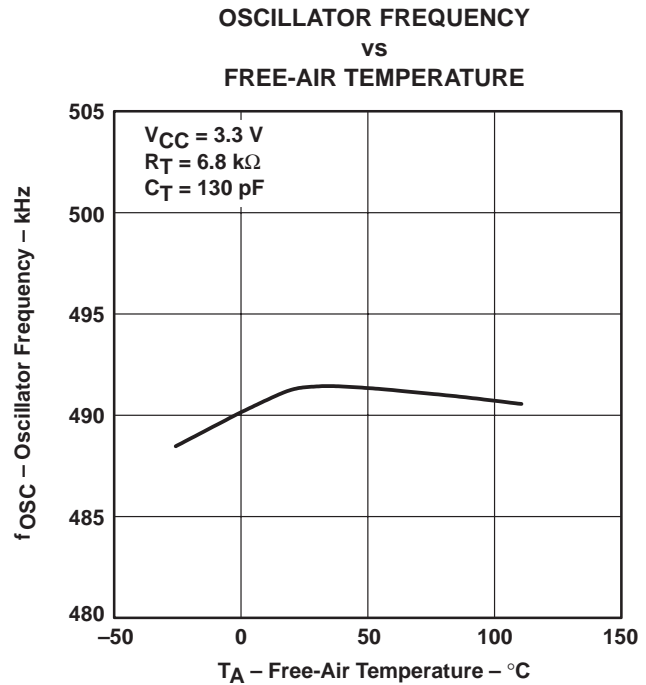

Figure 6

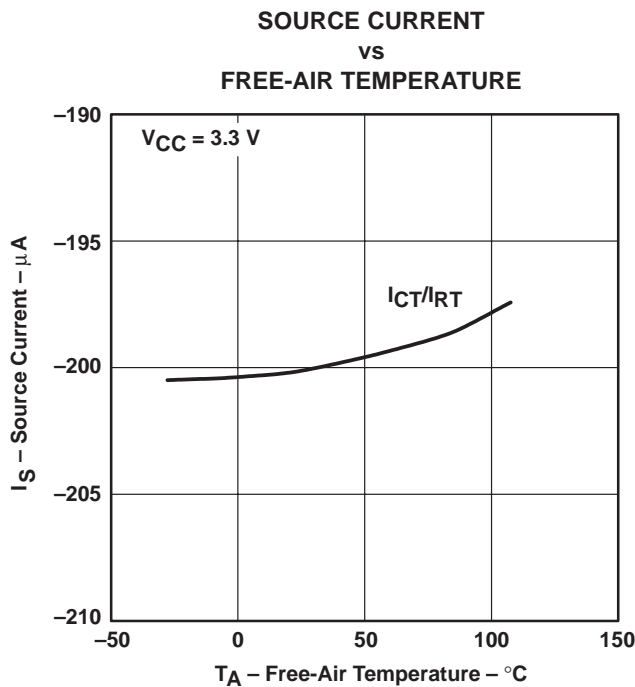

Figure 7

TYPICAL CHARACTERISTICS

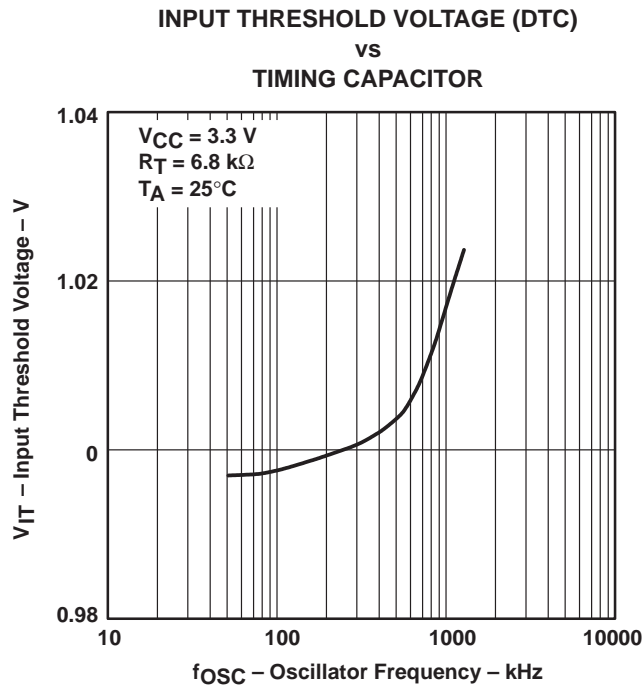

Figure 8

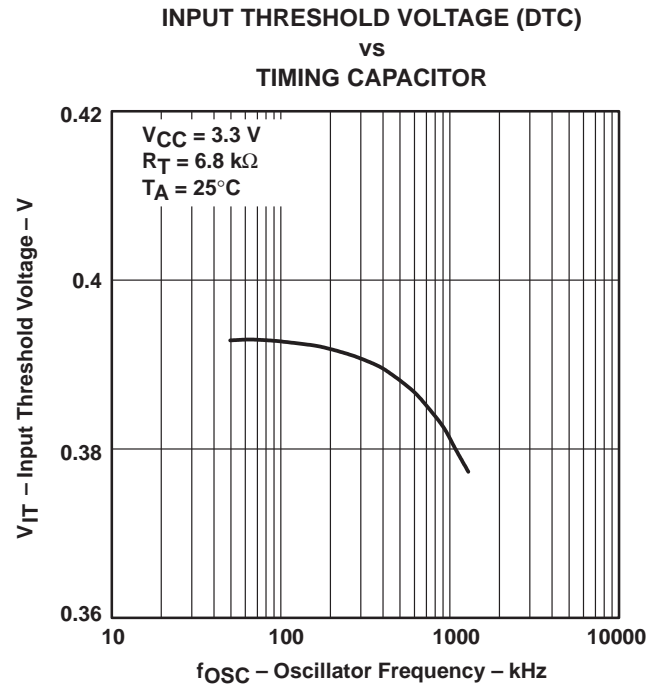

Figure 9

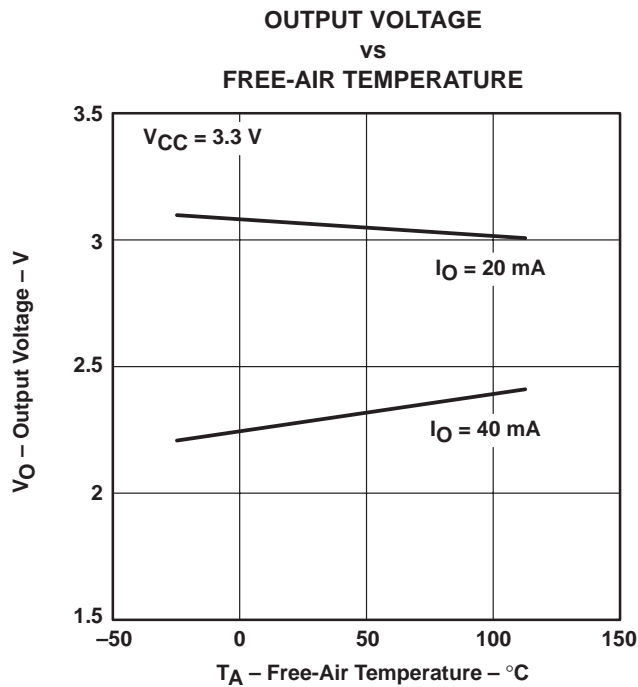

Figure 10

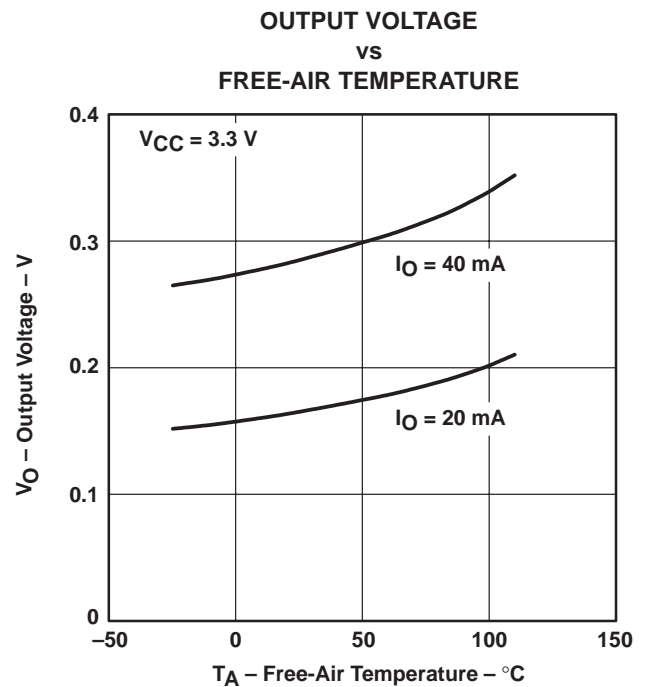
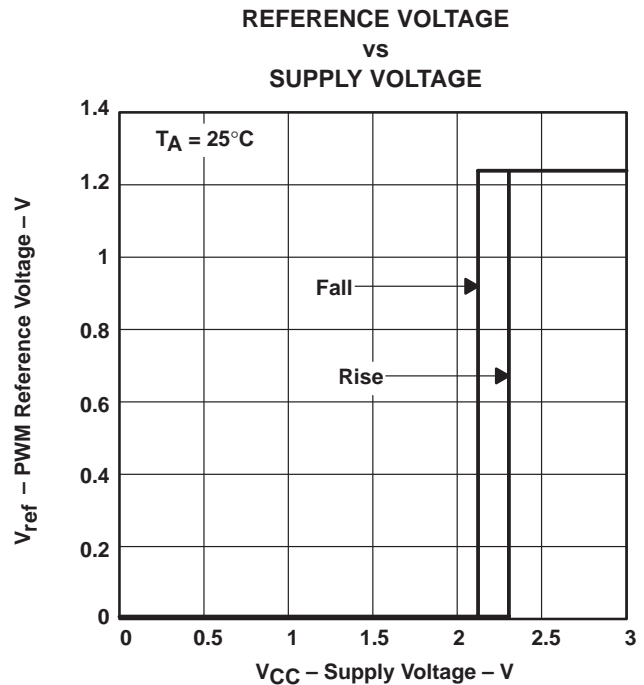
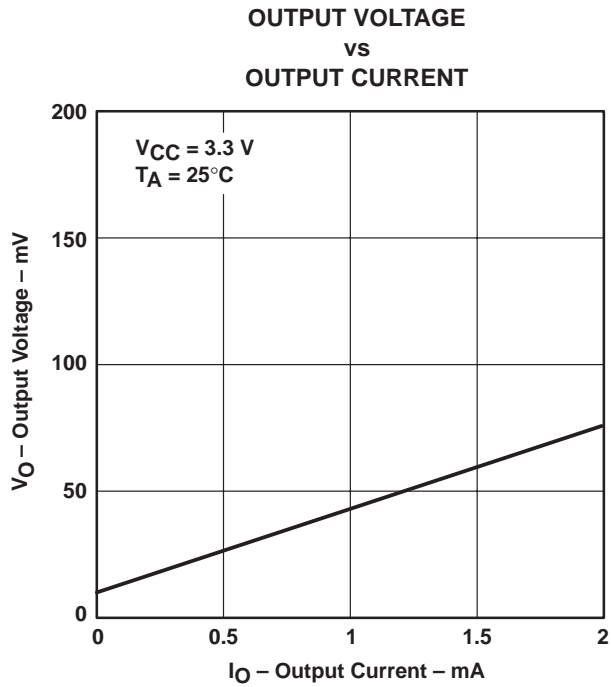
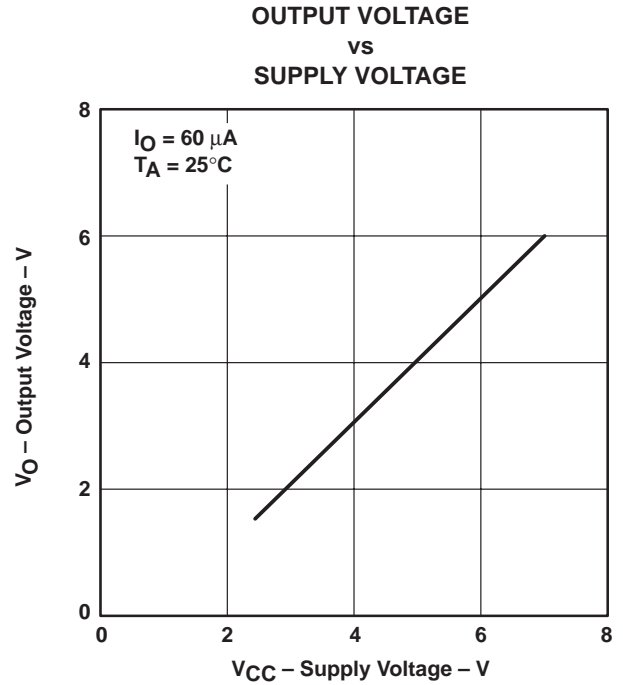
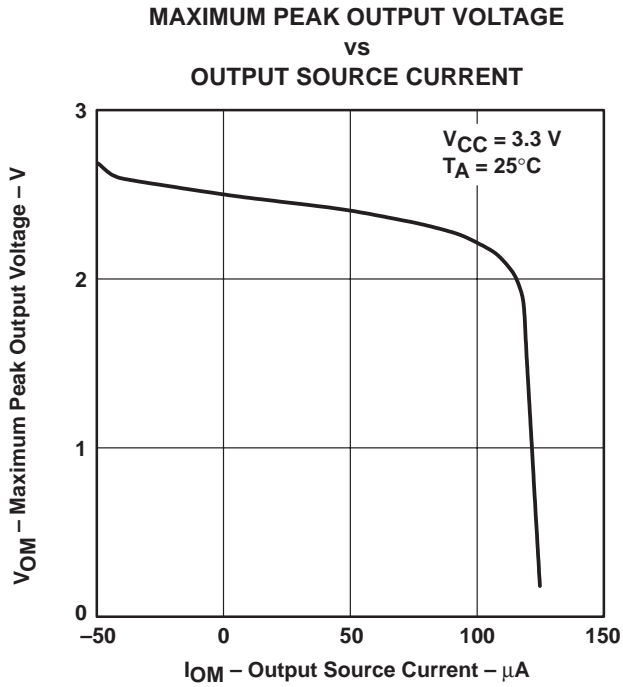

Figure 11

TYPICAL CHARACTERISTICS





TYPICAL CHARACTERISTICS

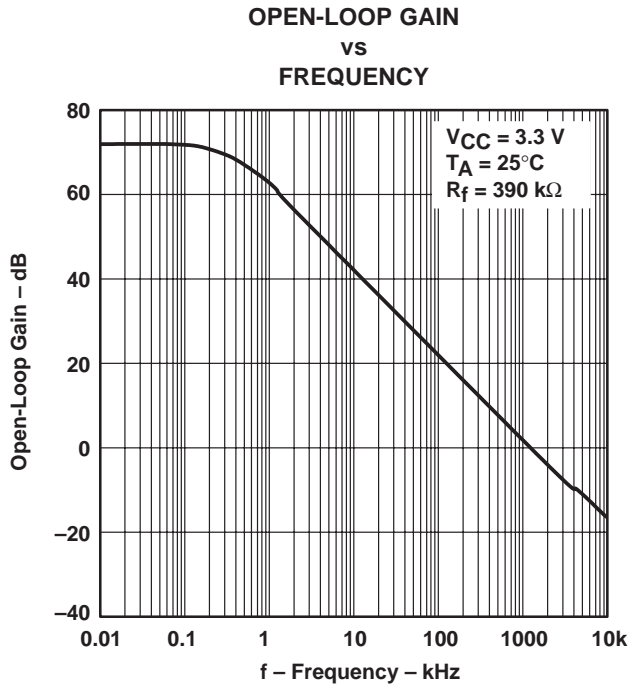

Figure 16

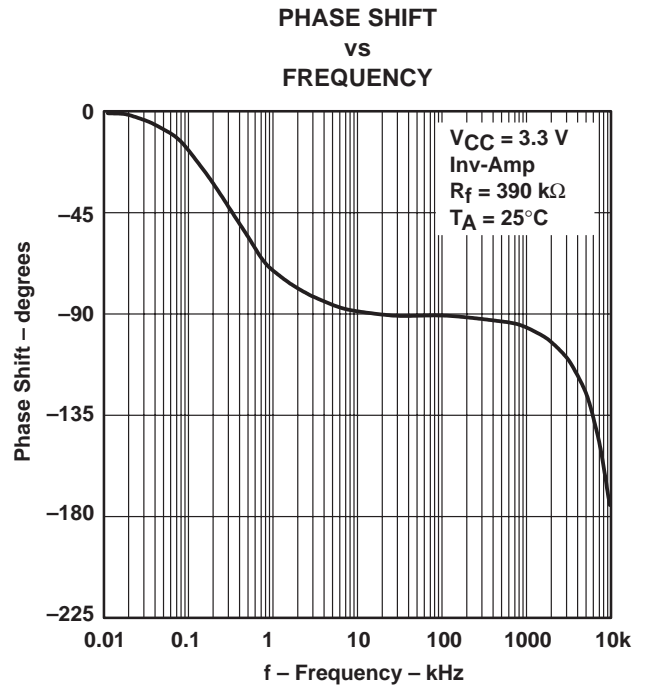

Figure 17

**PACKAGING INFORMATION**

Orderable Device	Status (1)	Package Type	Package Drawing	Pins	Package Qty	Eco Plan (2)	Lead/Ball Finish (6)	MSL Peak Temp (3)	Op Temp (°C)	Device Marking (4/5)	Samples
TPS5100IPW	ACTIVE	TSSOP	PW	16	90	Green (RoHS & no Sb/Br)	CU NIPDAU	Level-1-260C-UNLIM	-40 to 85	PU5100	Samples

(1) The marketing status values are defined as follows:

**ACTIVE:** Product device recommended for new designs.

**LIFEBUY:** TI has announced that the device will be discontinued, and a lifetime-buy period is in effect.

**NRND:** Not recommended for new designs. Device is in production to support existing customers, but TI does not recommend using this part in a new design.

**PREVIEW:** Device has been announced but is not in production. Samples may or may not be available.

**OBSOLETE:** TI has discontinued the production of the device.

(2) Eco Plan - The planned eco-friendly classification: Pb-Free (RoHS), Pb-Free (RoHS Exempt), or Green (RoHS & no Sb/Br) - please check <http://www.ti.com/productcontent> for the latest availability information and additional product content details.

**TBD:** The Pb-Free/Green conversion plan has not been defined.

**Pb-Free (RoHS):** TI's terms "Lead-Free" or "Pb-Free" mean semiconductor products that are compatible with the current RoHS requirements for all 6 substances, including the requirement that lead not exceed 0.1% by weight in homogeneous materials. Where designed to be soldered at high temperatures, TI Pb-Free products are suitable for use in specified lead-free processes.

**Pb-Free (RoHS Exempt):** This component has a RoHS exemption for either 1) lead-based flip-chip solder bumps used between the die and package, or 2) lead-based die adhesive used between the die and leadframe. The component is otherwise considered Pb-Free (RoHS compatible) as defined above.

**Green (RoHS & no Sb/Br):** TI defines "Green" to mean Pb-Free (RoHS compatible), and free of Bromine (Br) and Antimony (Sb) based flame retardants (Br or Sb do not exceed 0.1% by weight in homogeneous material)

(3) MSL, Peak Temp. - The Moisture Sensitivity Level rating according to the JEDEC industry standard classifications, and peak solder temperature.

(4) There may be additional marking, which relates to the logo, the lot trace code information, or the environmental category on the device.

(5) Multiple Device Markings will be inside parentheses. Only one Device Marking contained in parentheses and separated by a "~" will appear on a device. If a line is indented then it is a continuation of the previous line and the two combined represent the entire Device Marking for that device.

(6) Lead/Ball Finish - Orderable Devices may have multiple material finish options. Finish options are separated by a vertical ruled line. Lead/Ball Finish values may wrap to two lines if the finish value exceeds the maximum column width.

**Important Information and Disclaimer:** The information provided on this page represents TI's knowledge and belief as of the date that it is provided. TI bases its knowledge and belief on information provided by third parties, and makes no representation or warranty as to the accuracy of such information. Efforts are underway to better integrate information from third parties. TI has taken and continues to take reasonable steps to provide representative and accurate information but may not have conducted destructive testing or chemical analysis on incoming materials and chemicals. TI and TI suppliers consider certain information to be proprietary, and thus CAS numbers and other limited information may not be available for release.

In no event shall TI's liability arising out of such information exceed the total purchase price of the TI part(s) at issue in this document sold by TI to Customer on an annual basis.



PW (R-PDSO-G16)

PLASTIC SMALL OUTLINE



4040064-4/G 02/11

- NOTES:
- A. All linear dimensions are in millimeters. Dimensioning and tolerancing per ASME Y14.5M-1994.
  - B. This drawing is subject to change without notice.
  - C. Body length does not include mold flash, protrusions, or gate burrs. Mold flash, protrusions, or gate burrs shall not exceed 0,15 each side.
  - D. Body width does not include interlead flash. Interlead flash shall not exceed 0,25 each side.
  - E. Falls within JEDEC MO-153

PW (R-PDSO-G16)

PLASTIC SMALL OUTLINE



- NOTES:
- All linear dimensions are in millimeters.
  - This drawing is subject to change without notice.
  - Publication IPC-7351 is recommended for alternate designs.
  - Laser cutting apertures with trapezoidal walls and also rounding corners will offer better paste release. Customers should contact their board assembly site for stencil design recommendations. Refer to IPC-7525 for other stencil recommendations.
  - Customers should contact their board fabrication site for solder mask tolerances between and around signal pads.

## IMPORTANT NOTICE

Texas Instruments Incorporated and its subsidiaries (TI) reserve the right to make corrections, enhancements, improvements and other changes to its semiconductor products and services per JESD46, latest issue, and to discontinue any product or service per JESD48, latest issue. Buyers should obtain the latest relevant information before placing orders and should verify that such information is current and complete. All semiconductor products (also referred to herein as "components") are sold subject to TI's terms and conditions of sale supplied at the time of order acknowledgment.

TI warrants performance of its components to the specifications applicable at the time of sale, in accordance with the warranty in TI's terms and conditions of sale of semiconductor products. Testing and other quality control techniques are used to the extent TI deems necessary to support this warranty. Except where mandated by applicable law, testing of all parameters of each component is not necessarily performed.

TI assumes no liability for applications assistance or the design of Buyers' products. Buyers are responsible for their products and applications using TI components. To minimize the risks associated with Buyers' products and applications, Buyers should provide adequate design and operating safeguards.

TI does not warrant or represent that any license, either express or implied, is granted under any patent right, copyright, mask work right, or other intellectual property right relating to any combination, machine, or process in which TI components or services are used. Information published by TI regarding third-party products or services does not constitute a license to use such products or services or a warranty or endorsement thereof. Use of such information may require a license from a third party under the patents or other intellectual property of the third party, or a license from TI under the patents or other intellectual property of TI.

Reproduction of significant portions of TI information in TI data books or data sheets is permissible only if reproduction is without alteration and is accompanied by all associated warranties, conditions, limitations, and notices. TI is not responsible or liable for such altered documentation. Information of third parties may be subject to additional restrictions.

Resale of TI components or services with statements different from or beyond the parameters stated by TI for that component or service voids all express and any implied warranties for the associated TI component or service and is an unfair and deceptive business practice. TI is not responsible or liable for any such statements.

Buyer acknowledges and agrees that it is solely responsible for compliance with all legal, regulatory and safety-related requirements concerning its products, and any use of TI components in its applications, notwithstanding any applications-related information or support that may be provided by TI. Buyer represents and agrees that it has all the necessary expertise to create and implement safeguards which anticipate dangerous consequences of failures, monitor failures and their consequences, lessen the likelihood of failures that might cause harm and take appropriate remedial actions. Buyer will fully indemnify TI and its representatives against any damages arising out of the use of any TI components in safety-critical applications.

In some cases, TI components may be promoted specifically to facilitate safety-related applications. With such components, TI's goal is to help enable customers to design and create their own end-product solutions that meet applicable functional safety standards and requirements. Nonetheless, such components are subject to these terms.

No TI components are authorized for use in FDA Class III (or similar life-critical medical equipment) unless authorized officers of the parties have executed a special agreement specifically governing such use.

Only those TI components which TI has specifically designated as military grade or "enhanced plastic" are designed and intended for use in military/aerospace applications or environments. Buyer acknowledges and agrees that any military or aerospace use of TI components which have **not** been so designated is solely at the Buyer's risk, and that Buyer is solely responsible for compliance with all legal and regulatory requirements in connection with such use.

TI has specifically designated certain components as meeting ISO/TS16949 requirements, mainly for automotive use. In any case of use of non-designated products, TI will not be responsible for any failure to meet ISO/TS16949.

### Products

Audio	<a href="http://www.ti.com/audio">www.ti.com/audio</a>
Amplifiers	<a href="http://amplifier.ti.com">amplifier.ti.com</a>
Data Converters	<a href="http://dataconverter.ti.com">dataconverter.ti.com</a>
DLP® Products	<a href="http://www.dlp.com">www.dlp.com</a>
DSP	<a href="http://dsp.ti.com">dsp.ti.com</a>
Clocks and Timers	<a href="http://www.ti.com/clocks">www.ti.com/clocks</a>
Interface	<a href="http://interface.ti.com">interface.ti.com</a>
Logic	<a href="http://logic.ti.com">logic.ti.com</a>
Power Mgmt	<a href="http://power.ti.com">power.ti.com</a>
Microcontrollers	<a href="http://microcontroller.ti.com">microcontroller.ti.com</a>
RFID	<a href="http://www.ti-rfid.com">www.ti-rfid.com</a>
OMAP Applications Processors	<a href="http://www.ti.com/omap">www.ti.com/omap</a>
Wireless Connectivity	<a href="http://www.ti.com/wirelessconnectivity">www.ti.com/wirelessconnectivity</a>

### Applications

Automotive and Transportation	<a href="http://www.ti.com/automotive">www.ti.com/automotive</a>
Communications and Telecom	<a href="http://www.ti.com/communications">www.ti.com/communications</a>
Computers and Peripherals	<a href="http://www.ti.com/computers">www.ti.com/computers</a>
Consumer Electronics	<a href="http://www.ti.com/consumer-apps">www.ti.com/consumer-apps</a>
Energy and Lighting	<a href="http://www.ti.com/energy">www.ti.com/energy</a>
Industrial	<a href="http://www.ti.com/industrial">www.ti.com/industrial</a>
Medical	<a href="http://www.ti.com/medical">www.ti.com/medical</a>
Security	<a href="http://www.ti.com/security">www.ti.com/security</a>
Space, Avionics and Defense	<a href="http://www.ti.com/space-avionics-defense">www.ti.com/space-avionics-defense</a>
Video and Imaging	<a href="http://www.ti.com/video">www.ti.com/video</a>

### TI E2E Community

[e2e.ti.com](http://e2e.ti.com)