

# TPS5120-Q1

## DUAL OUTPUT, TWO-PHASE SYNCHRONOUS BUCK DC/DC CONTROLLER

SGLS225B – JANUARY 2004 – REVISED APRIL 2008

- Qualified for Automotive Applications
- Independent Dual-Outputs Operate 180° Out of Phase
- Wide Input Voltage Range: 4.5-V – 28-V
- Adjustable Output Voltage Down to 0.9 V
- Pin-Selectable PWM/SKIP Mode for High Efficiency Under Light Loads
- Synchronous Buck Operation Allows up to 95% Efficiency
- Separate Standby Control and Overcurrent Protection For Each Channel
- Programmable Short-Circuit Protection
- Low Supply (1 mA) and Shutdown (1 nA) Current
- Power Good Output
- High-Speed Error Amplifiers
- Sequencing Easily Achieved by Selecting Softstart Capacitor Values.
- 5-V Linear Regulator Power Internal IC Circuitry
- 30-Pin TSSOP Packaging
- Gate Leakage Test Passing Level is 50 V

DBT PACKAGE  
(TOP VIEW)

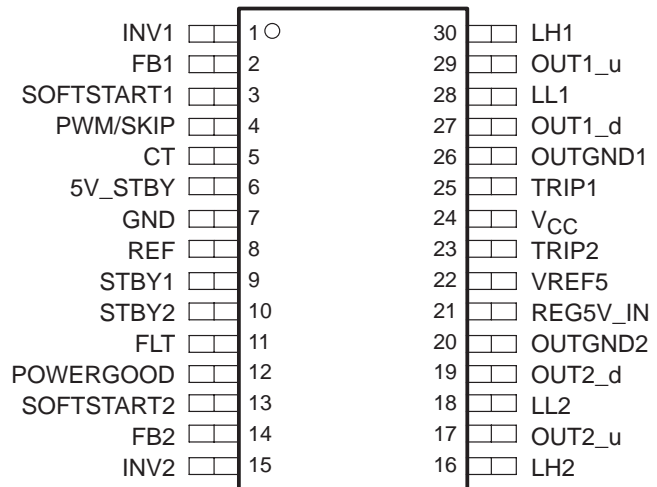

### description

The TPS5120 is a dual channel, high-efficiency synchronous buck controller where the outputs run 180 degrees out of phase, which lowers the input current ripple, thereby reducing the input capacitance cost. The PWM/SKIP pin allows the operating mode to switch from PWM mode to skip mode under light load conditions. The skip mode enables a lower operating frequency and shortens the pulse width to the low-side MOSFET, increasing the efficiency under light load conditions. These two modes, along with synchronous-rectifier drivers, dead time, and very low quiescent current, allow power to be conserved and the battery life to be extended under all load conditions. The 1.5 A (typical) high-side and low-side MOSFET drivers on-chip are designed to drive less expensive N-channel MOSFETs. The resistorless current protection and fixed high-side driver voltage simplify the power supply design and reduce the external parts count. Each channel is independent, offering a separate controller, overcurrent protection, and standby control. Sequencing is flexible and can be tailored by choosing different softstart capacitor values. Other features, such as undervoltage lockout, power good, overvoltage, undervoltage, and programmable short-circuit protection promote system reliability.

### ORDERING INFORMATION†

T <sub>A</sub>	PACKAGE‡
	TSSOP (DBT)
-40°C to 125°C	TPS5120QDBTRQ1

† For the most current package and ordering information, see the Package Option Addendum at the end of this document, or see the TI web site at <http://www.ti.com>.

‡ Package drawings, thermal data, and symbolization are available at <http://www.ti.com/packaging>.



Please be aware that an important notice concerning availability, standard warranty, and use in critical applications of Texas Instruments semiconductor products and disclaimers thereto appears at the end of this data sheet.

PRODUCTION DATA information is current as of publication date. Products conform to specifications per the terms of Texas Instruments standard warranty. Production processing does not necessarily include testing of all parameters.



POST OFFICE BOX 655303 • DALLAS, TEXAS 75265

Copyright © 2008 Texas Instruments Incorporated

# TPS5120-Q1 DUAL OUTPUT, TWO-PHASE SYNCHRONOUS BUCK DC/DC CONTROLLER

SGLS225B – JANUARY 2004 – REVISED APRIL 2008

## typical design

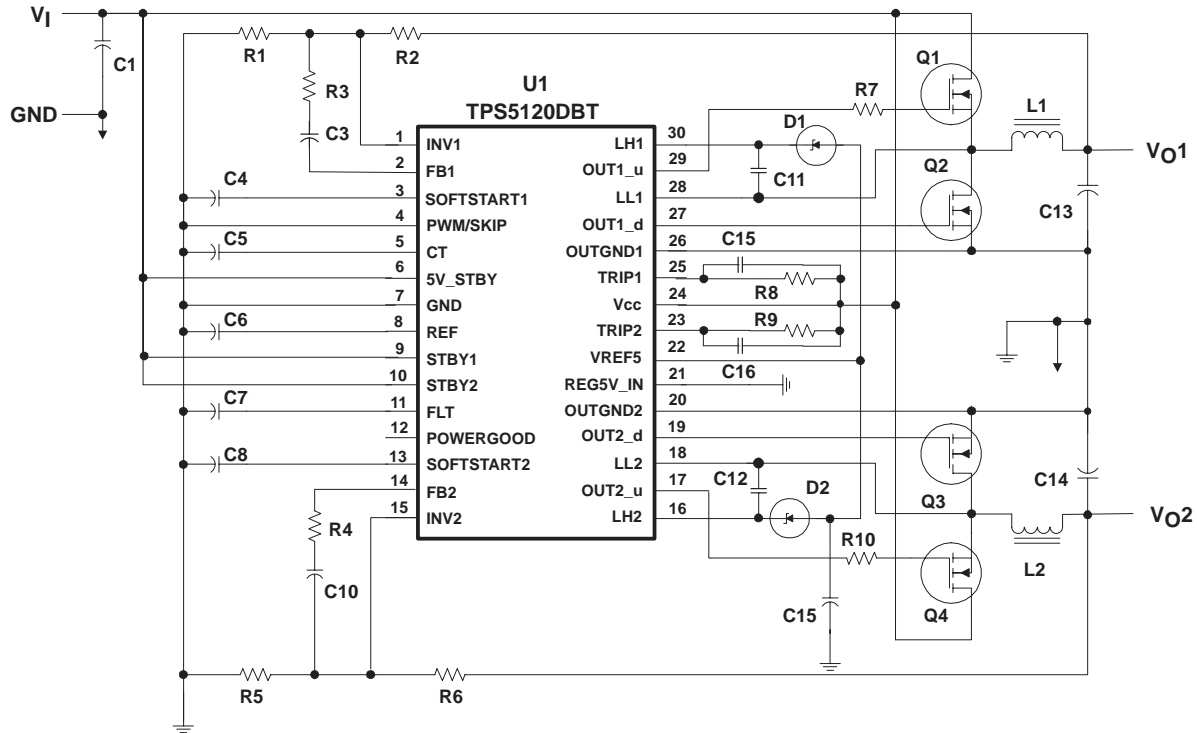

Figure 1. EVM Typical Design

# TPS5120-Q1

## DUAL OUTPUT, TWO-PHASE SYNCHRONOUS BUCK DC/DC CONTROLLER

SGLS225B – JANUARY 2004 – REVISED APRIL 2008

### functional block diagram

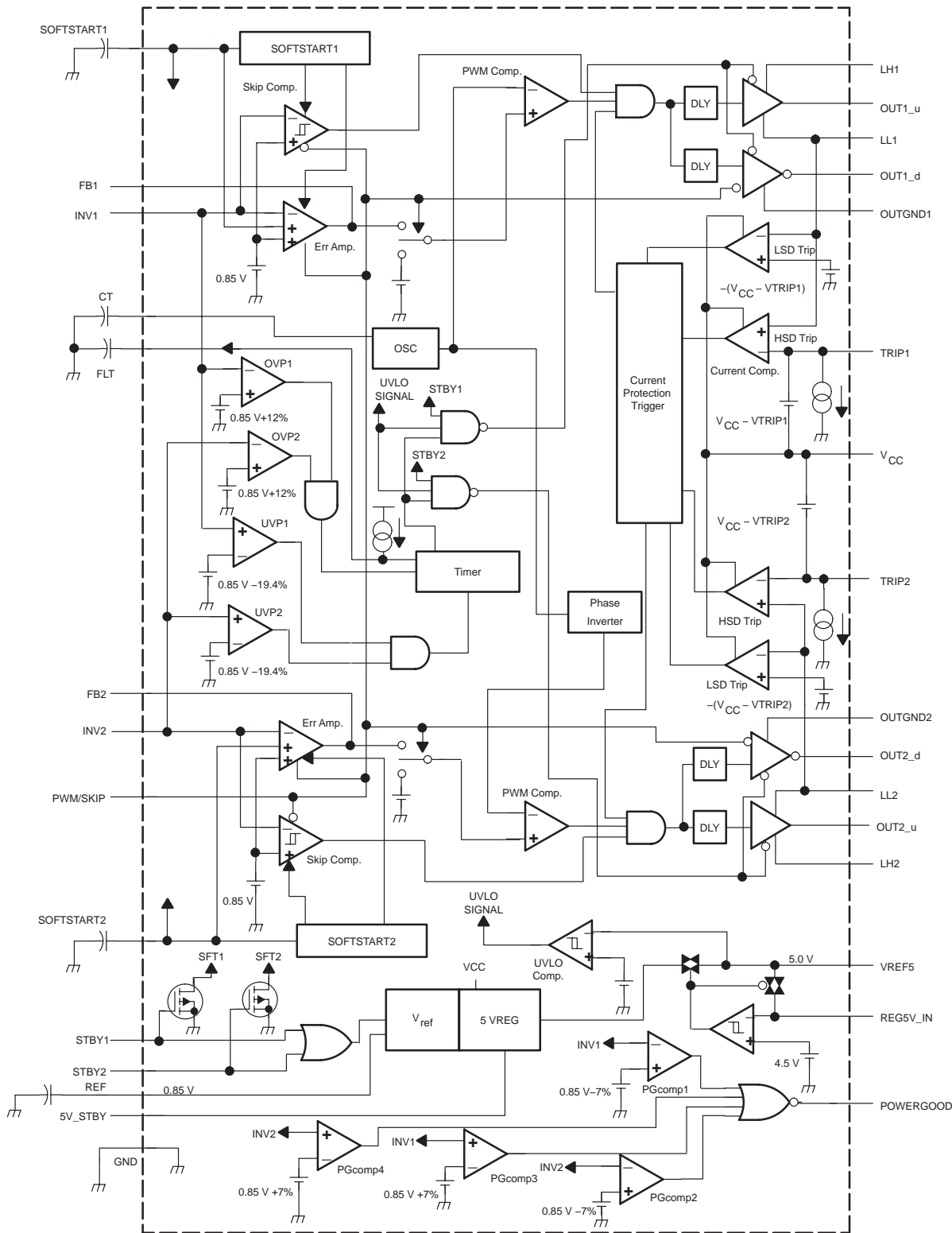

# TPS5120-Q1

## DUAL OUTPUT, TWO-PHASE SYNCHRONOUS BUCK DC/DC CONTROLLER

SGLS225B – JANUARY 2004 – REVISED APRIL 2008

### Terminal Functions

TERMINAL NAME	NO.	I/O	DESCRIPTION
CT	5	I/O	External capacitor from CT to GND for adjusting the triangle oscillator
FB1	2	O	Feedback output of CH1 error amplifier
FB2	14	O	Feedback output of CH2 error amplifier
GND	7		Control GND
INV1	1	I	Inverting input of the CH1 error amplifier, skip comparator, and OVP1/UVP1 comparator
INV2	15	I	Inverting input of the CH2 error amplifier, skip comparator, and OVP2/UVP2 comparator
LH1	30	I/O	Bootstrap capacitor connection for CH1 high-side gate drive
LH2	16	I/O	Bootstrap capacitor connection for CH2 high-side gate drive
LL1	28	I/O	Bootstrap this pin low for CH1 high-side gate driving return and output current protection. Connect this pin to the junction of the high-side and low-side FETs for a floating drive configuration.
LL2	18	I/O	Bootstrap this pin low for CH2 high-side gate driving return and output current protection. Connect this pin to the junction of the high-side and low-side FETs for a floating drive configuration.
OUT1_d	27	O	Gate drive output for CH1 low-side gate drive
OUT2_d	19	O	Gate drive output for CH2 low-side gate drive
OUT1_u	29	O	Gate drive output for CH1 high-side switching FETs
OUT2_u	17	O	Gate drive output for CH2 high-side switching FETs
OUTGND1	26		Ground for CH1 FET drivers
OUTGND2	20		Ground for CH2 FET drivers
POWERGOOD	12	O	Power good open-drain output. When low, POWERGOOD reports an output fail condition. PG comparators monitor both SMPS's over voltage and UVLO of VREF5. The threshold is $\pm 7\%$ . When the SMPS starts up, the POWERGOOD pin's output goes high. POWERGOOD also monitors VREF5's UVLO output.
PWM/SKIP	4	I	PWM/SKIP mode select pin. The PWM/SKIP pin is used to change the output's operating mode. If this terminal is lower than 0.5 V, it works in PWM mode. When a minimum voltage of 2 V is applied, the device operates in skip mode. In light load condition (< 0.2 A), the skip mode gives a short pulse to the low-side FETs instead of a full pulse. With this control, switching frequency is lowered and switching loss is reduced. Also, the output capacitor energy discharging through the output inductor and low-side FETs is stopped. Therefore, TPS5120 achieves a higher efficiency in light load conditions.
REF	8	O	0.85-V reference voltage output. The 0.85-V reference voltage is used for setting the output voltage and the voltage protection. This reference voltage is dropped down from a 5-V regulator.
REG5V_IN	21	I	External 5-V input
FLT	11	I/O	Fault latch timer pin. An external capacitor is connected between FLT and GND to set the FLT enable time up.
SOFTSTART1	3	I/O	External capacitor from SOFTSTART1 to GND for CH1 softstart control. Separate soft-start terminals make it possible to set the start-up time of each output independently.
SOFTSTART2	13	I/O	External capacitor from SOFTSTART2 to GND for CH2 softstart control. Separate soft-start terminals make it possible to set the start-up time of each output independently.
STBY1	9	I	Standby control for CH1. SMPS1 can be switched into standby mode separately by grounding the STBY1 pin.
STBY2	10	I	Standby control for CH2. SMPS2 can be switched into standby mode separately by grounding the STBY2 pin.
TRIP1	25	I	External resistor connection for CH1 output current control
TRIP2	23	I	External resistor connection for CH2 output current control
VCC	24		Supply voltage input
VREF5	22	O	5-V internal regulator output
5V_STBY	6	I	5-V linear regulator control



---

## detailed description

### switching-mode power supply (SMPS) 1, 2

The TPS5120 includes dual SMPS controllers that operate 180° out of phase and at the same frequency. Both channels have standby and softstart.

### 5-V regulator

An internal linear voltage regulator is used for the high-side driver bootstrap voltage and source of VREF (0.85 V). When the 5-V regulator is disconnected from the MOSFET drivers, it is only used for the source of VREF. Since the input voltage range is from 4.5 V to 28 V, this feature offers a fixed voltage for the bootstrap voltage so that the drive design is much easier. It is also used for powering the low-side driver. The tolerance is 4%. The 5-V regulator is disabled when STBY1, STBY2, and 5V\_STBY are all set low.

### 5-V switch

If the internal 5-V switch senses the 5-V input from the REG5V\_IN pin, the internal 5-V linear regulator is disconnected from the MOSFET drivers. The external 5 V is then used for both the low-side driver and the high-side bootstrap, thus, increasing the efficiency.

### error amplifier

Each channel has its own error amplifier to regulate the output voltage of the synchronous buck converter. It is used in the PWM mode for the high output current condition (> 0.2 A). The unity gain bandwidth is 2.5 MHz. This decreases the amplifier delay during fast load transients and contributes to a fast transient response.

### skip comparator

In skip mode, each channel has its own hysteretic comparator to regulate the output voltage of the synchronous buck converter. The hysteresis is set internally and is typically set at 9 mV. The delay from the comparator input to the driver output is typically 1.2 μs.

### low-side driver

The low-side driver is designed to drive low  $r_{ds(on)}$  N-channel MOSFETs. The maximum drive voltage is 5 V from VREF5. The current rating of the driver is typically 1.5 A at source and sink.

### high-side driver

The high-side driver is designed to drive low  $r_{ds(on)}$  N-channel MOSFETs. The current rating of the driver is 1.2 A at source and sink. When configured as a floating driver, the bias voltage to the driver is developed from VREF5, limiting the maximum drive voltage between OUTx\_u and LLx to 5 V. The maximum voltage that can be applied between LHx and OUTGND is 33 V.

### deadtime

Deadtime prevents shoot through current from flowing through the main power FETs during switching transitions by actively controlling the turnon time of the MOSFETs drivers.

### current protection

Overcurrent protection is achieved by comparing the drain-to-source voltage of the high-side and low-side MOSFET devices to a set-point voltage. This voltage is set using an external resistor between  $V_{CC}$  and the TRIP1 or TRIP2 terminals. If the drain-to-source voltage up exceeds the set-point voltage during high-side conduction, the current limit circuit terminates the high-side driver pulse. If the set-point voltage is exceeded during low-side conduction, the low-side pulse is extended through the next cycle. Together this action has the effect of decreasing the output voltage until the undervoltage protection circuit is activated and the fault latch is set and both the high and low-side MOSFET drivers are shut off.

# TPS5120-Q1

## DUAL OUTPUT, TWO-PHASE SYNCHRONOUS BUCK DC/DC CONTROLLER

SGLS225B – JANUARY 2004 – REVISED APRIL 2008

---

### detailed description (continued)

#### overvoltage protection

For overvoltage protection (OVP), the TPS5120 monitors INV pin voltage. When the INV voltage is higher than 0.95 V (+12%), the OVP comparator output goes high and the FLT timer starts to charge an external capacitor connected to FLT. After a set time, the FLT circuit latches the MOSFET drivers off.

#### undervoltage protection

For undervoltage protection (UVP), the TPS5120 monitors INV pin voltage. When the INV voltage is lower than 0.68 V (–19.4%), the OVP comparator output goes high, and the FLT timer starts to charge an external capacitor connected to FLT. Also, when the current comparator triggers the OCP, the UVP comparator detects the under voltage output and starts the FLT capacitor charge. After a set time, the FLT circuit latches off all of the MOSFET drivers.

#### FLT

When an OVP or UVP comparator output goes high, the FLT circuit starts to charge the FLT capacitor. If the FLT pin voltage goes beyond a constant level, the TPS5120 latches the MOSFET drivers. At this time, the state of MOSFET is different depending on the OVP alert and the UVP alert. Also, the enable time used to latch the MOSFET driver is decided by the capacity of the FLT capacitor. The charging constant current value is also different depending on whether it is an OVP alert or a UVP alert. The difference is shown in the following equation:

$$\text{FLT source current (OVP)} = \text{FLT source current (UVP)} \times 5$$

#### shutdown

The TPS5120 can be shut down by grounding STBY1, STBY2, and 5V\_STBY. The shutdown current is as low as 1  $\mu$ A.

#### UVLO

When the input voltage goes up to about 4 V, the TPS5120 is operational. When the input voltage is lower than the turnon value, the device is turned off. The typical hysteresis voltage is 40 mV.

#### phase Inverter

Phase inverter controls the phase of SMPS1 and SMPS 2. SMPS1 operates in phase with the OSC. SMPS2 operates 180° out of phase from SMPS1. This allows smaller input capacitors to be used.

#### oscillator

The TPS5120 has a triangle oscillator generator internal to the IC. The oscillation frequency is set by the size of the capacitor connected to the CT pin. The voltage amplitude is 0.43 V ~ 1.17 V.



# TPS5120-Q1

## DUAL OUTPUT, TWO-PHASE SYNCHRONOUS BUCK DC/DC CONTROLLER

SGLS225B – JANUARY 2004 – REVISED APRIL 2008

**Table 1. Logic Chart**

5V_STBY	STBY1	STBY2	SMPS1	SMPS2	5 V REGULATOR	POWERGOOD
L	L	L	Disable	Disable	Disable	Disable
L	L	H	Disable	Enable	Enable	Active†
L	H	L	Enable	Disable	Enable	Active†
L	H	H	Enable	Enable	Enable	Active
H	L	L	Disable	Disable	Enable	L
H	L	H	Disable	Enable	Enable	Active†
H	H	L	Enable	Disable	Enable	Active†
H	H	H	Enable	Enable	Enable	Active

† PG is set high during a softstart.

### POWERGOOD timing sequence

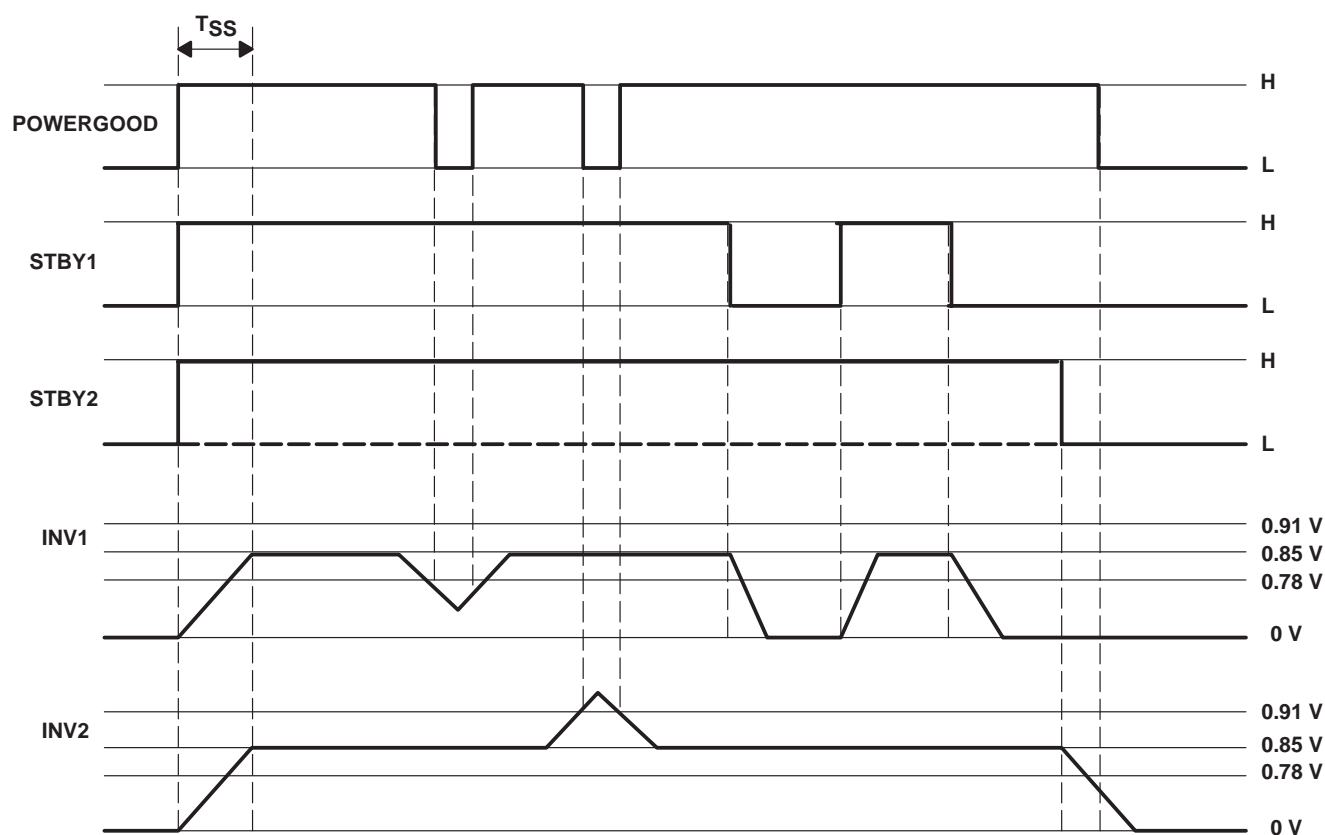

During a softstart, this channel's powergood comparator output is fixed low (POWERGOOD output is high).

# TPS5120-Q1

## DUAL OUTPUT, TWO-PHASE SYNCHRONOUS BUCK DC/DC CONTROLLER

SGLS225B – JANUARY 2004 – REVISED APRIL 2008

### absolute maximum ratings over operating free-air temperature (unless otherwise noted)†

Supply voltage, $V_{CC}$ (see Note 1)	–0.3 V to 30 V
Input voltage: INV1, INV2, CT, PWM/SKIP, REG5V_IN, SOFTSTART1, SOFTSTART2, . . . .	–0.3 V to 7 V
FLT, POWERGOOD	–0.3 V to 7 V
STBY1, STBY2, 5V_STBY, TRIP1, TRIP2	–0.3 V to 30 V
Output voltage: LL1, LL2	–1.0 V to 30 V
OUT1_u, OUT2_u	–1.0 V to 35 V
LH1, LH2	–0.3 V to 35 V
OUT1_d, OUT2_d, 5V_OUT, FB1, FB2	–0.3 V to 7 V
REF	–0.3 V to 3 V
OUT1_u, LH1 to LL1	–0.3 V to 7 V
OUT2_u, LH2 to LL2	–0.3 V to 7 V
Power dissipation ( $T_A \leq 25^\circ\text{C}$ ), $P_D$	874 mW
Gate Leakage Test Results	$\pm 50$ V
Operating junction temperature range, $T_J$	–40°C to 125°C
Storage temperature range, $T_{stg}$	–55°C to 150°C

† Stresses beyond those listed under “absolute maximum ratings” may cause permanent damage to the device. These are stress ratings only, and functional operation of the device at these or any other conditions beyond those indicated under “recommended operating conditions” is not implied. Exposure to absolute-maximum-rated conditions for extended periods may affect device reliability.

- NOTES: 1. All voltage values are with respect to the network ground terminal unless otherwise noted.  
 2. This rating is specified at duty = 10% on output rise and fall each pulse. Each pulse width (rise and fall) for the peak current should not exceed 2  $\mu\text{s}$ .  
 3. See Dissipation Rating Table for free-air temperature range above 25°C.

DISSIPATION RATING TABLE

PACKAGE	$T_A \leq 25^\circ\text{C}$	DERATING FACTOR	POWER DISSIPATION
	POWER RATING	ABOVE $T_A = 25^\circ\text{C}$	$T_A = 85^\circ\text{C}$
DBT	874 mW	6.993 mW/°C	454 mW

### recommended operating conditions

		MIN	NOM	MAX	UNIT
Supply voltage, $V_{CC}$		4.5		28	V
Input voltage, $V_I$	INV1, INV2, CT, PWM/SKIP, SOFTSTART1, SOFTSTART2, FLT			6	V
	REG5V_IN, POWERGOOD	–0.1		5.5	
	STBY1, STBY2, 5V_STBY			28	
	OUT1_u, OUT2_u, LH1, LH2			33	
	TRIP1, TRIP2	–0.1		28	
Oscillator frequency, $f_{osc}$			300	500	kHz
Operating junction temperature range, $T_J$		–40		125	°C





# TPS5120-Q1

## DUAL OUTPUT, TWO-PHASE SYNCHRONOUS BUCK DC/DC CONTROLLER

SGLS225B – JANUARY 2004 – REVISED APRIL 2008

electrical characteristics over recommended free-air temperature range,  $V_{CC} = 7\text{ V}$  (unless otherwise noted)

### reference voltage

PARAMETER		TEST CONDITIONS	MIN	TYP	MAX	UNIT
$V_{ref}$	Reference voltage			0.85		V
$V_{ref(tol)}$	Reference voltage tolerance	$T_A = 25^\circ\text{C}$ , $I = 50\ \mu\text{A}$	-1%		1%	
		$T_J = -20^\circ\text{C}$ to $125^\circ\text{C}$ , $I = 50\ \mu\text{A}$	-1.5%		1.5%	
		$T_J = -40^\circ\text{C}$ to $125^\circ\text{C}$ , $I = 50\ \mu\text{A}$	-2%		2%	
$R_{(egin)}$	Line regulation	$V_{CC} = 4.5\text{ V}$ to $28\text{ V}$ , $I = 50\ \mu\text{A}$		0.05	3	mV
$R_{(egl)}$	Load regulation	$I = 0.1\ \mu\text{A}$ to $1\text{ mA}$		0.15	5	mV

### oscillator

PARAMETER		TEST CONDITIONS	MIN	TYP	MAX	UNIT
$f_{osc}$	Frequency	PWM mode, $C_T = 44\text{ pF}$ , $T_A = 25^\circ\text{C}$		300		kHz
$V_{OH}$	High level output voltage	DC	1	1.1	1.2	V
		$f_{osc} = 300\text{ kHz}$		1.17		
$V_{OL}$	Low level output voltage	DC	0.4	0.5	0.6	V
		$f_{osc} = 300\text{ kHz}$		0.43		

### error amplifier

PARAMETER		TEST CONDITIONS	MIN	TYP	MAX	UNIT
$V_{IO}$	Input offset voltage	$T_A = 25^\circ\text{C}$		2	10	mV
	Open-loop voltage gain		50			dB
	Unity-gain bandwidth			2.5		MHz
$I_{(snk)}$	Output sink current	$V_O = 1\text{ V}$	0.3	0.7		mA
$I_{(src)}$	Output source current	$V_O = 1\text{ V}$	0.2	0.9		mA

### skip comparator

PARAMETER		TEST CONDITIONS	MIN	TYP	MAX	UNIT
$V_{hys}$	Hysteresis window	SKIP mode		9		mV

### duty control

PARAMETER		TEST CONDITIONS	MIN	TYP	MAX	UNIT
DUTY	Maximum duty cycle	300 kHz, $V_I = 0\text{ V}$		83%		

### control

PARAMETER		TEST CONDITIONS	MIN	TYP	MAX	UNIT
$V_{IH}$	High-level input voltage	STBY1, STBY2	2.2			V
		PWM/SKIP, 5V_STBY	2.2			
$V_{IL}$	Low-level input voltage	STBY1, STBY2			0.3	V
		PWM/SKIP, 5V_STBY			0.3	

### 5-V internal switch

PARAMETER		TEST CONDITIONS	MIN	TYP	MAX	UNIT
$V_{(TO\_H)}$	Threshold		4.2		4.8	V
$V_{(TO\_L)}$			4.1		4.7	
$V_{hys}$	Hysteresis		30		200	mV



# TPS5120-Q1

## DUAL OUTPUT, TWO-PHASE SYNCHRONOUS BUCK DC/DC CONTROLLER

SGLS225B – JANUARY 2004 – REVISED APRIL 2008

electrical characteristics over recommended free-air temperature range,  $V_{CC} = 7\text{ V}$  (unless otherwise noted) (continued)

### 5-V regulator

PARAMETER		TEST CONDITIONS	MIN	TYP	MAX	UNIT
$V_O$	Output voltage	$I_O = 0\text{ mA to }50\text{ mA}$ , $T_A = 25^\circ\text{C}$	4.8		5.2	V
$R_{(egin)}$	Line regulation	$V_{CC} = 5.5\text{ V to }28\text{ V}$ , $I = 10\text{ mA}$			20	mV
$R_{(egl)}$	Load regulation	$I = 1\text{ mA to }10\text{ mA}$ , $V_{CC} = 5.5\text{ V}$			40	mV
$I_{OS}$	Short circuit output current	$5V_{REG} = 0\text{ V}$ , $T_A = 25^\circ\text{C}$	65			mA
$V_{(TO\_H)}$	UVLO threshold voltage	5V_OUT voltage	3.6		4.2	V
$V_{(TO\_L)}$			3.5		4.1	
$V_{hys}$	Hysteresis	5V_OUT voltage	20		150	mV

### output drivers

PARAMETER		TEST CONDITIONS	MIN	TYP	MAX	UNIT
	OUT_u sink current	$V_O = 3\text{ V}$		1.2		A
	OUT_u source current	$V_O = 2\text{ V}$		-1.5		A
	OUT_d sink current	$V_O = 3\text{ V}$		1.5		A
	OUT_d source current	$V_O = 2\text{ V}$		-1.5		A
$I_{(TRIP)}$	TRIP pin current	$T_A = 25^\circ\text{C}$	11.5	13	14.5	$\mu\text{A}$

### soft start

PARAMETER		TEST CONDITIONS	MIN	TYP	MAX	UNIT
$I_{(SOFT)}$	Soft start current		1.6	2.3	2.9	$\mu\text{A}$
$V_{(TO\_H)}$	Threshold voltage (SKIP mode)			3.7		V
$V_{(TO\_L)}$				2.5		

### output voltage monitor

PARAMETER		TEST CONDITIONS	MIN	TYP	MAX	UNIT
	OVP comparator threshold		0.91	0.95	0.99	V
	UVP comparator threshold		0.64	0.68	0.72	V
	PG comparator 1, 2 threshold		0.75	0.78	0.81	V
	PG comparator 3, 4 threshold		0.88	0.91	0.94	V
	PG propagation delay from INV to POWERGOOD	Turnon		13		$\mu\text{s}$
		Turnoff		1.2		
	Timer latch current source	UVP protection	1.5	2.3	3.1	$\mu\text{A}$
		OVP protection	8	11.5	15	

### supply current

PARAMETER		TEST CONDITIONS	MIN	TYP	MAX	UNIT
$I_{CC}$	Supply current	$T_A = 25^\circ\text{C}$ , $CT = 0\text{ V}$ , $INV = 0\text{ V}$		1.1	1.5	mA
$I_{CC(S)}$	Shutdown current	STBY 1, STBY2, 5V_STBY = 0 V		0.001	10	$\mu\text{A}$



# TPS5120-Q1

## DUAL OUTPUT, TWO-PHASE SYNCHRONOUS BUCK DC/DC CONTROLLER

SGLS225B – JANUARY 2004 – REVISED APRIL 2008

### TYPICAL CHARACTERISTICS

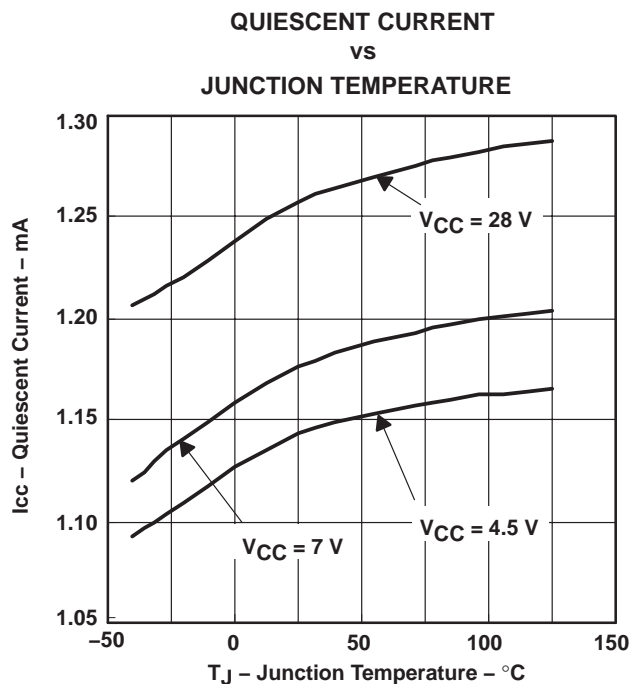

Figure 2

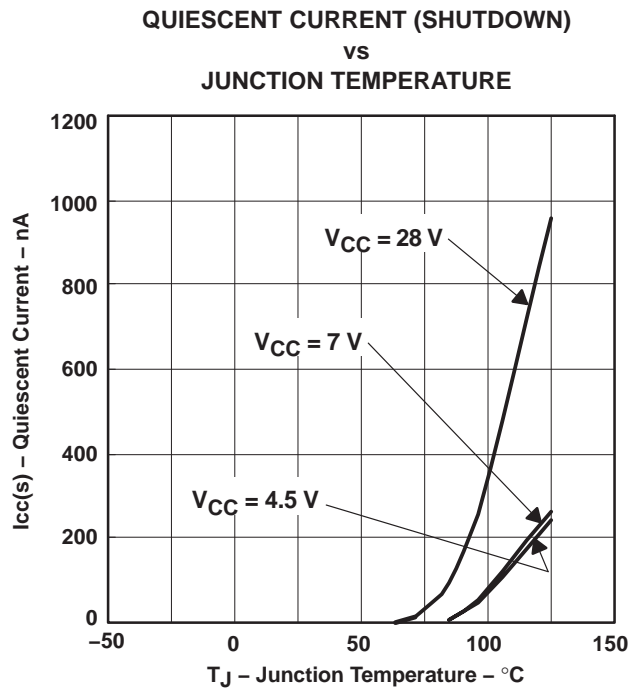

Figure 3

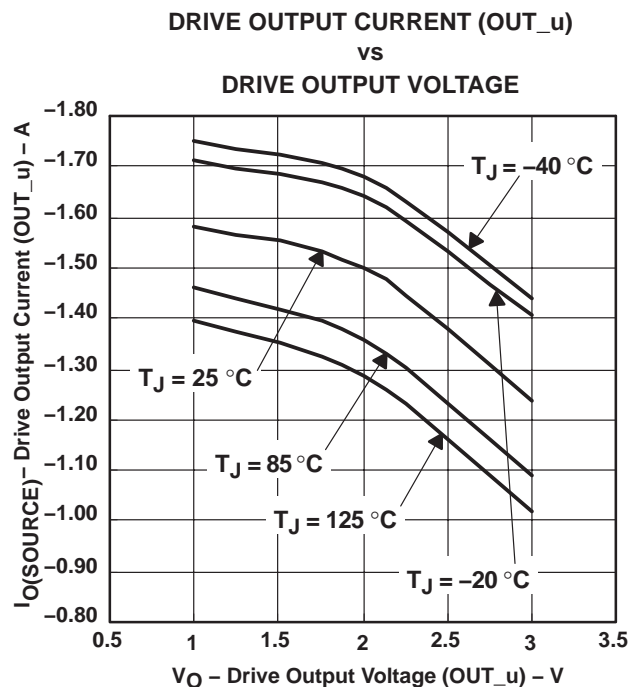

Figure 4

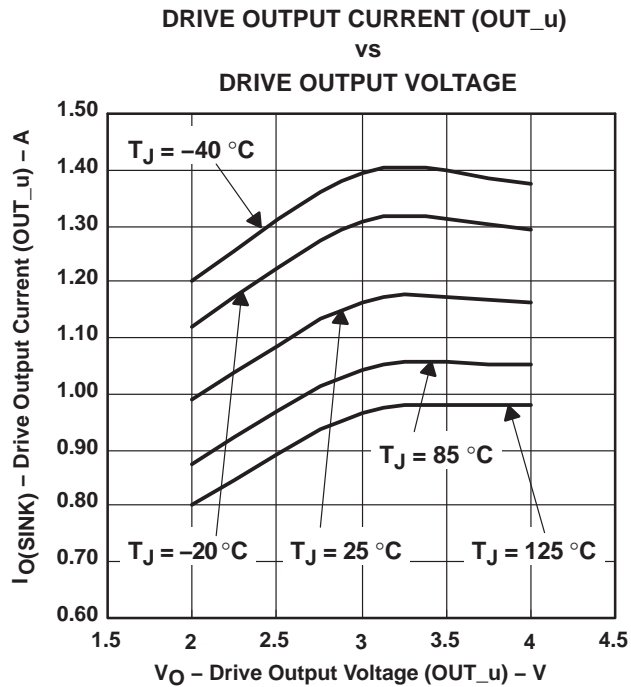

Figure 5

# TPS5120-Q1

## DUAL OUTPUT, TWO-PHASE SYNCHRONOUS BUCK DC/DC CONTROLLER

SGLS225B – JANUARY 2004 – REVISED APRIL 2008

### TYPICAL CHARACTERISTICS

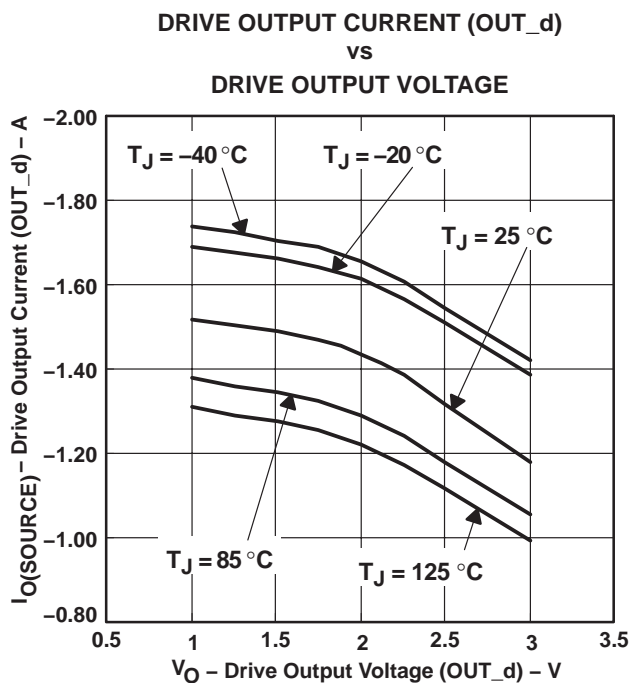

Figure 6



Figure 7

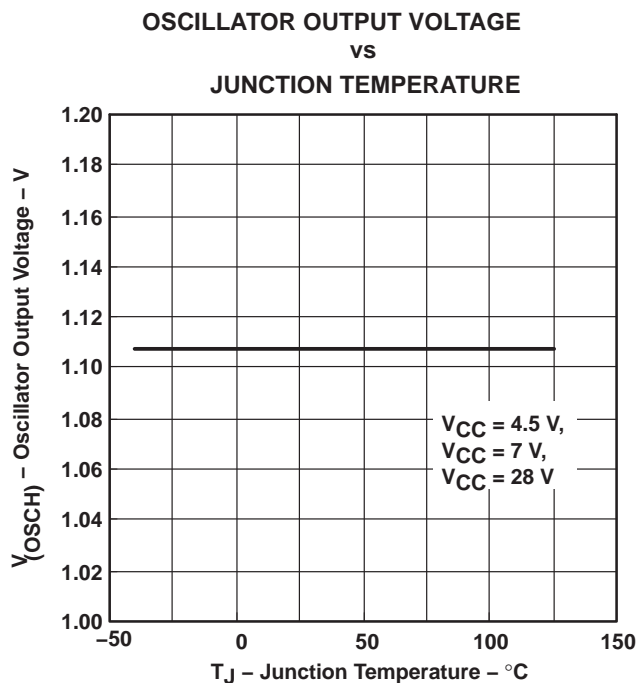

Figure 8

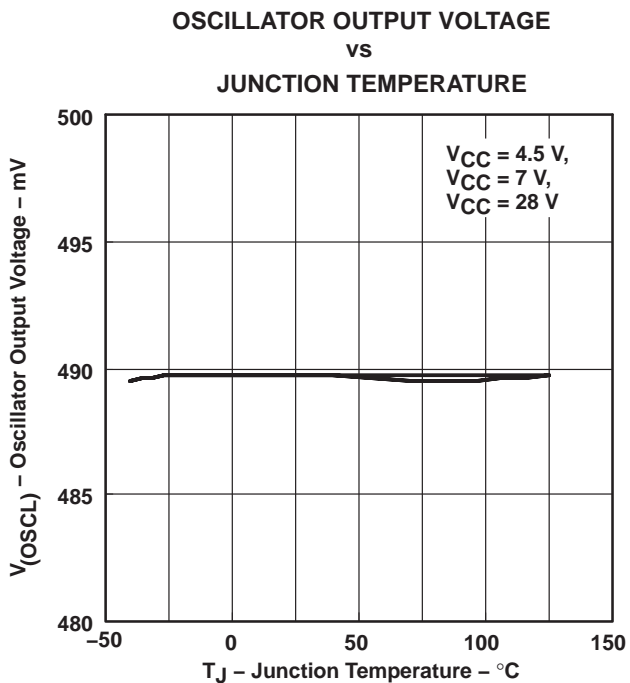
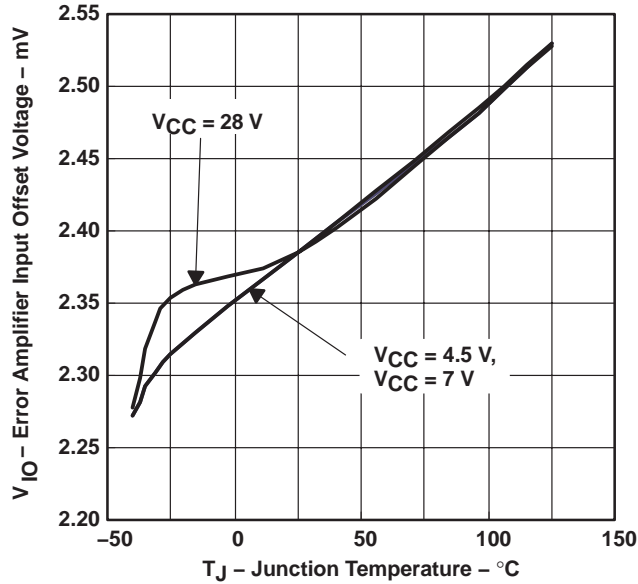

Figure 9

**TYPICAL CHARACTERISTICS**

**ERROR AMPLIFIER INPUT OFFSET VOLTAGE  
vs  
JUNCTION TEMPERATURE**



**Figure 10**

**ERROR AMPLIFIER OUTPUT VOLTAGE  
vs  
JUNCTION TEMPERATURE**

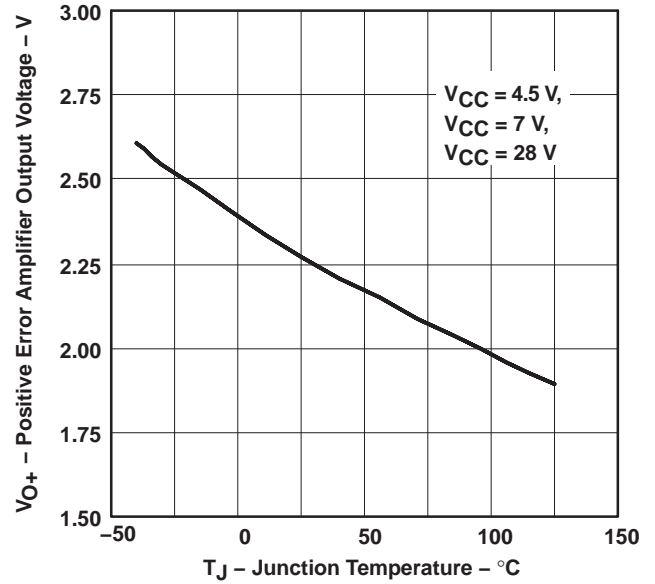

**Figure 11**

**ERROR AMPLIFIER OUTPUT VOLTAGE  
vs  
JUNCTION TEMPERATURE**

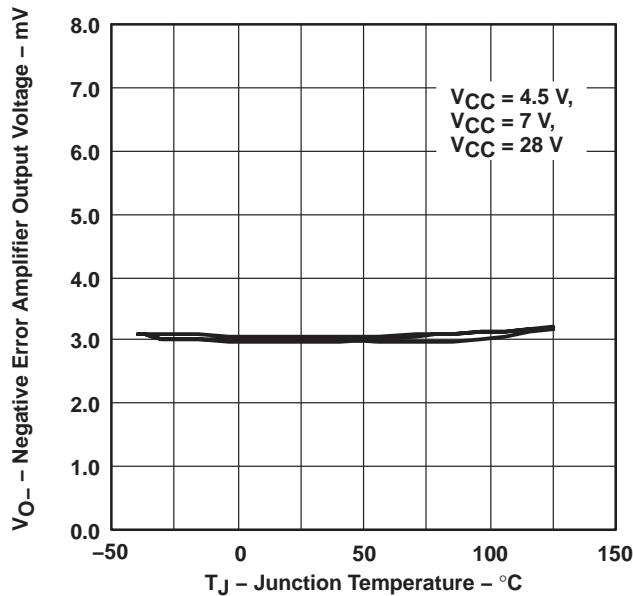

**Figure 12**

**SKIP COMPARATOR HYSTERESIS VOLTAGE  
vs  
JUNCTION TEMPERATURE**

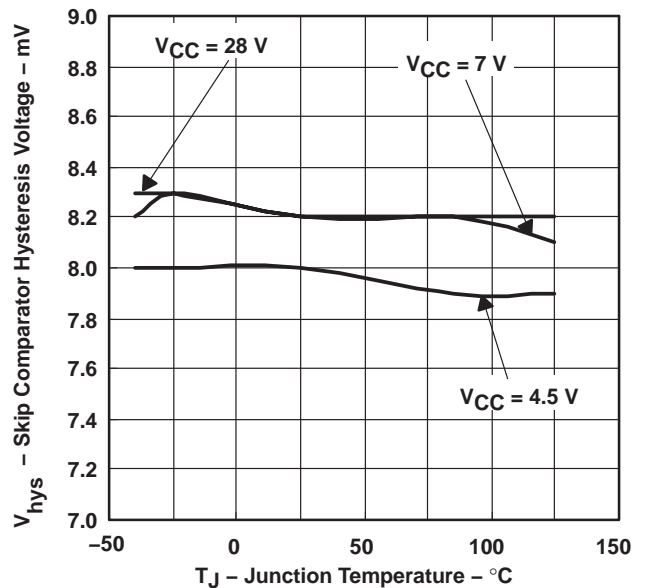

**Figure 13**

# TPS5120-Q1

## DUAL OUTPUT, TWO-PHASE SYNCHRONOUS BUCK DC/DC CONTROLLER

SGLS225B – JANUARY 2004 – REVISED APRIL 2008

### TYPICAL CHARACTERISTICS

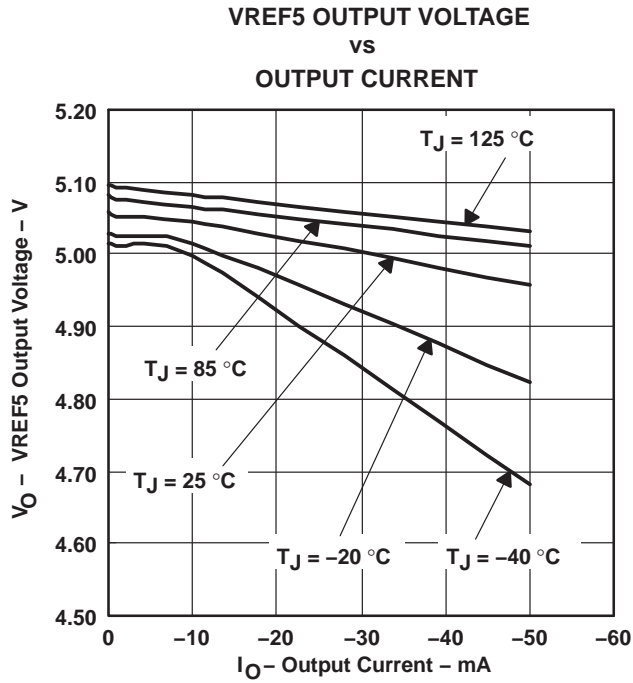

Figure 14

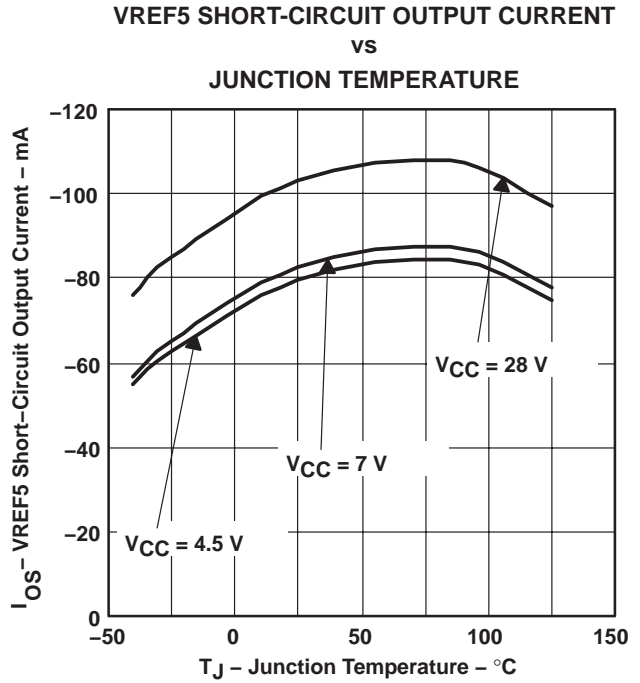

Figure 15

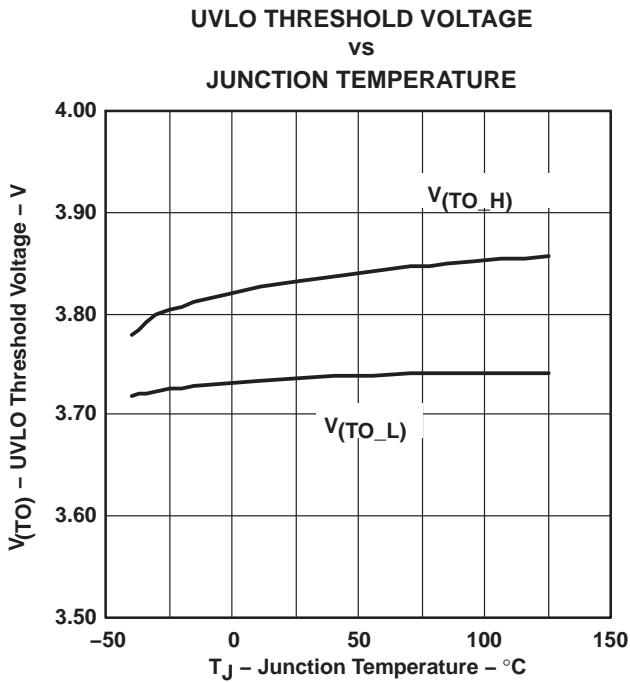

Figure 16

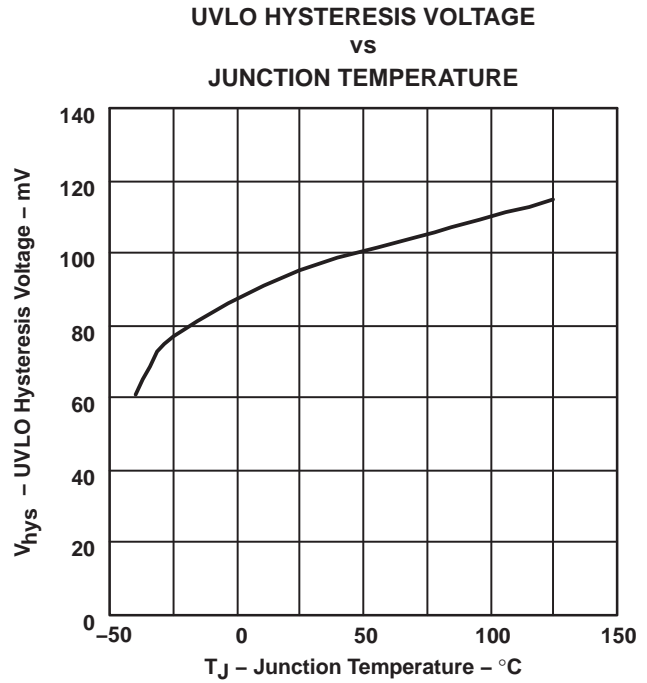

Figure 17



# TPS5120-Q1

## DUAL OUTPUT, TWO-PHASE SYNCHRONOUS BUCK DC/DC CONTROLLER

SGLS225B – JANUARY 2004 – REVISED APRIL 2008

### TYPICAL CHARACTERISTICS

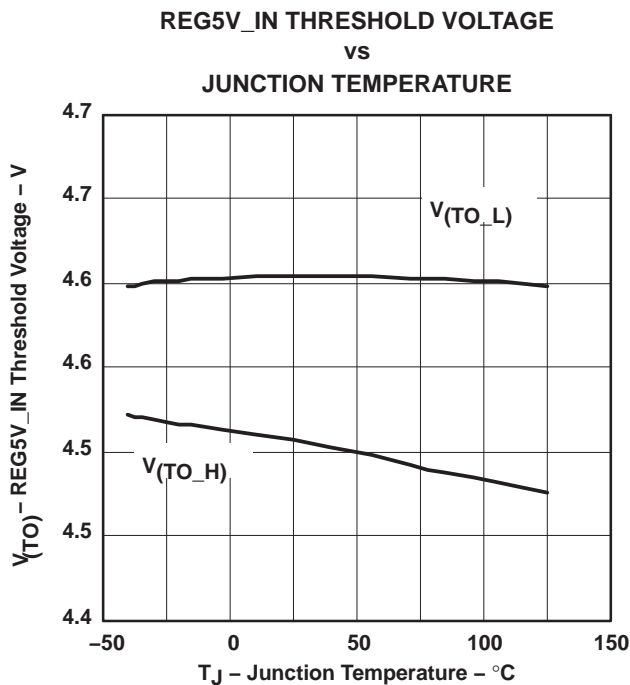

Figure 18

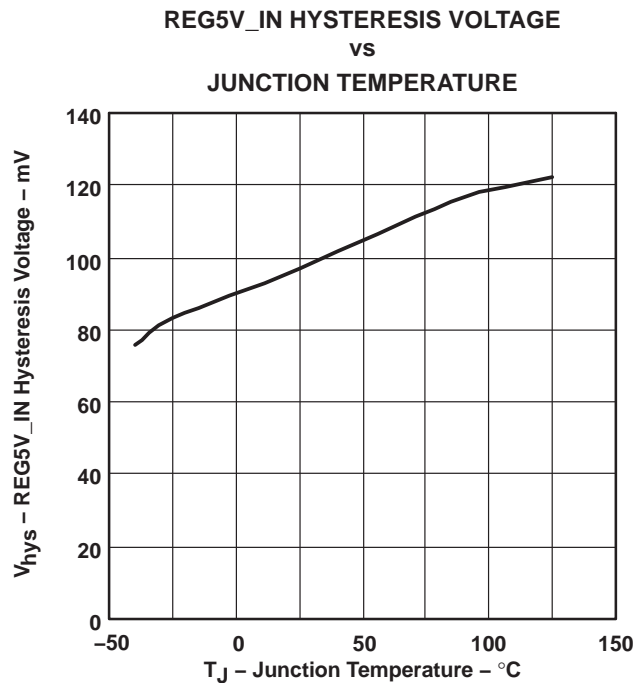

Figure 19

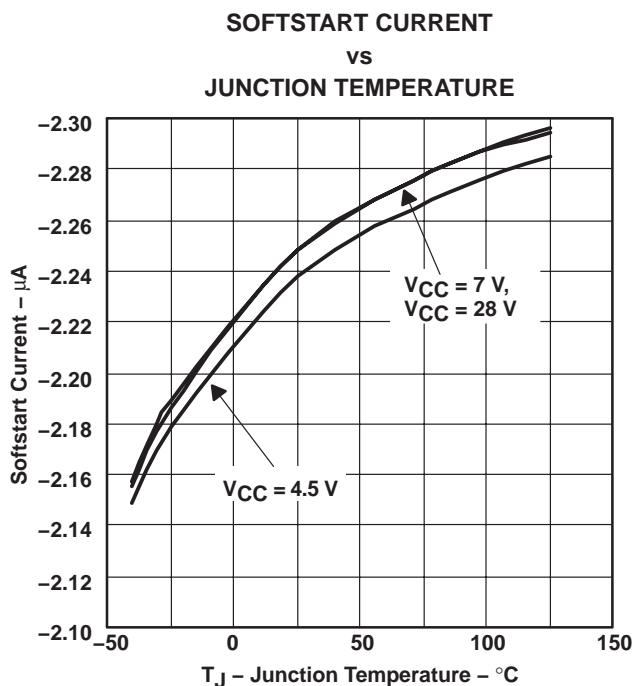

Figure 20

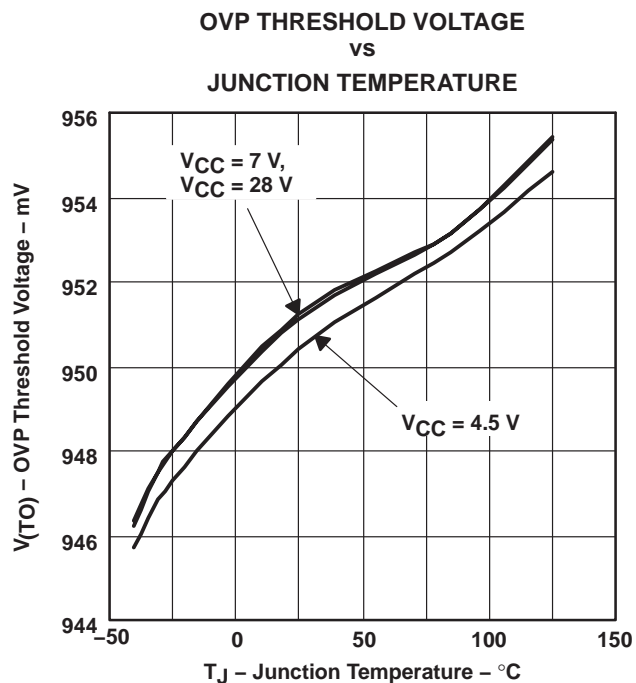

Figure 21

# TPS5120-Q1

## DUAL OUTPUT, TWO-PHASE SYNCHRONOUS BUCK DC/DC CONTROLLER

SGLS225B – JANUARY 2004 – REVISED APRIL 2008

### TYPICAL CHARACTERISTICS

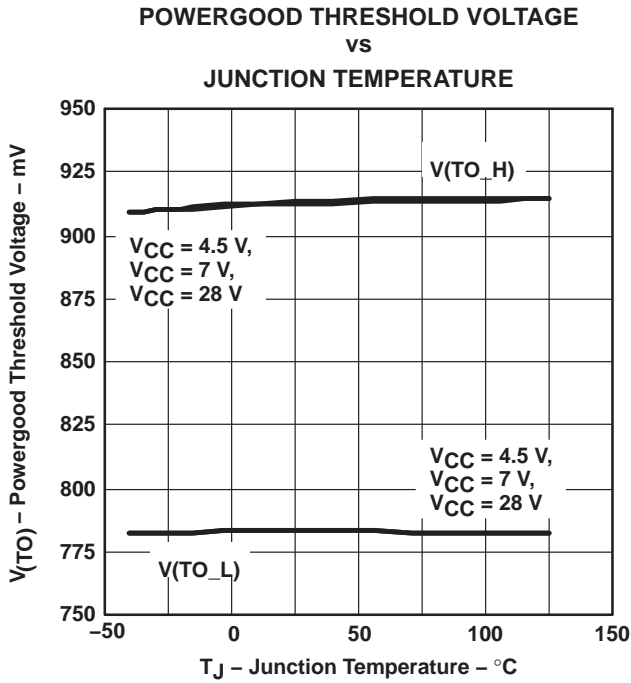

Figure 22

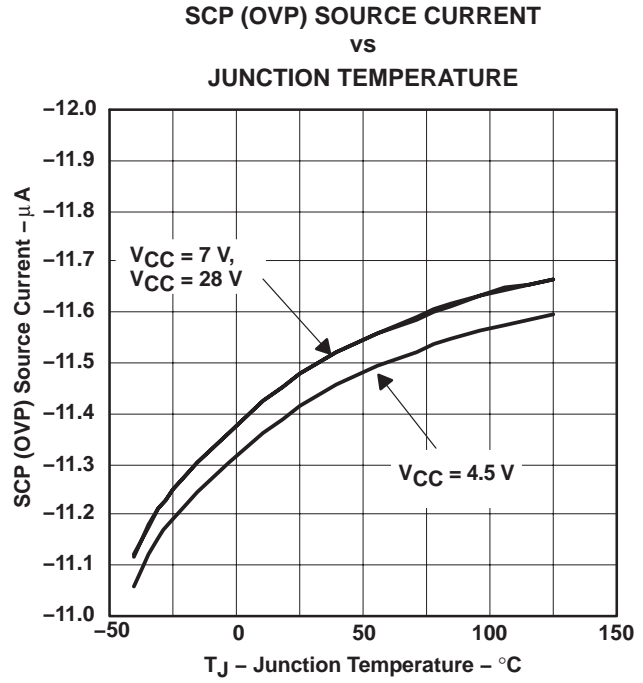

Figure 23

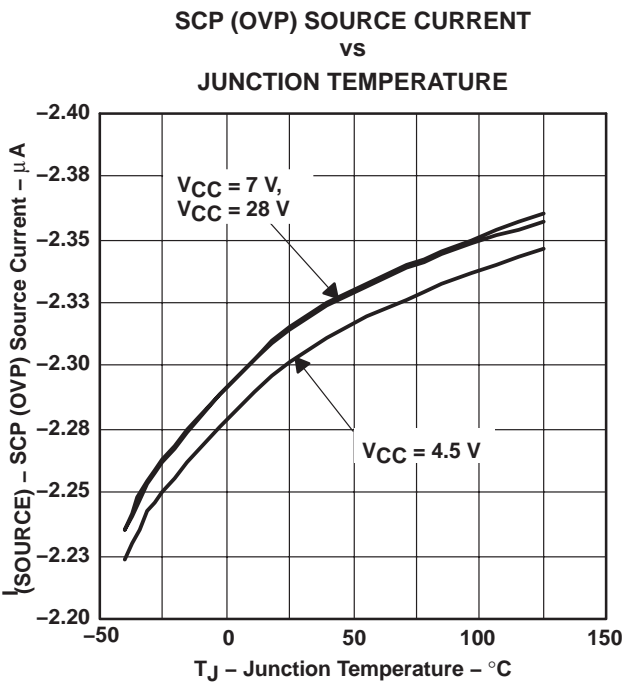

Figure 24

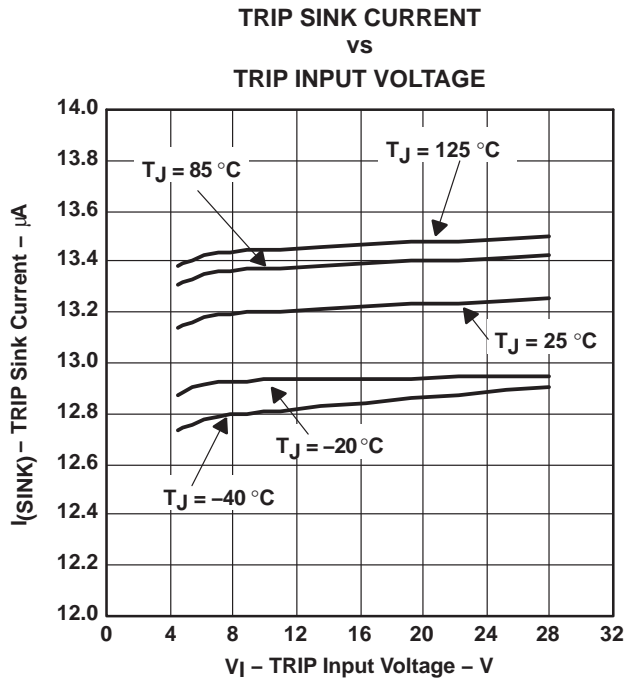

Figure 25





# TPS5120-Q1

## DUAL OUTPUT, TWO-PHASE SYNCHRONOUS BUCK DC/DC CONTROLLER

SGLS225B – JANUARY 2004 – REVISED APRIL 2008

### TYPICAL CHARACTERISTICS

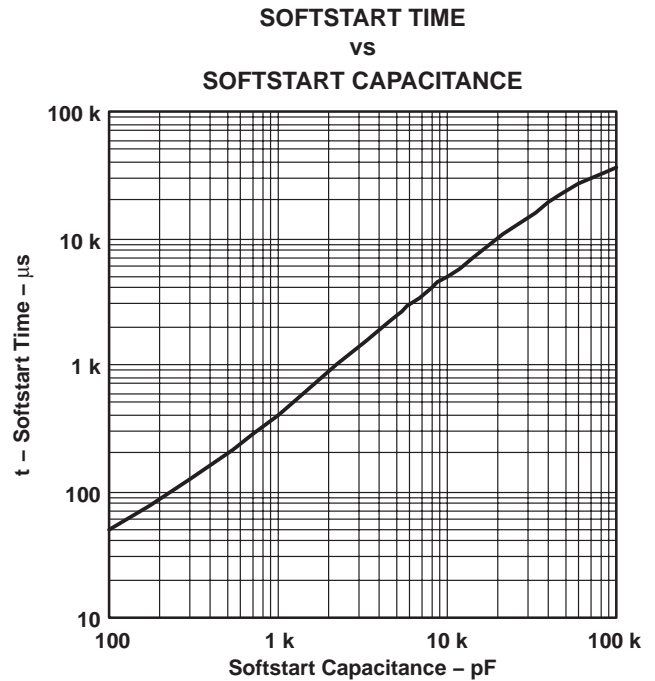
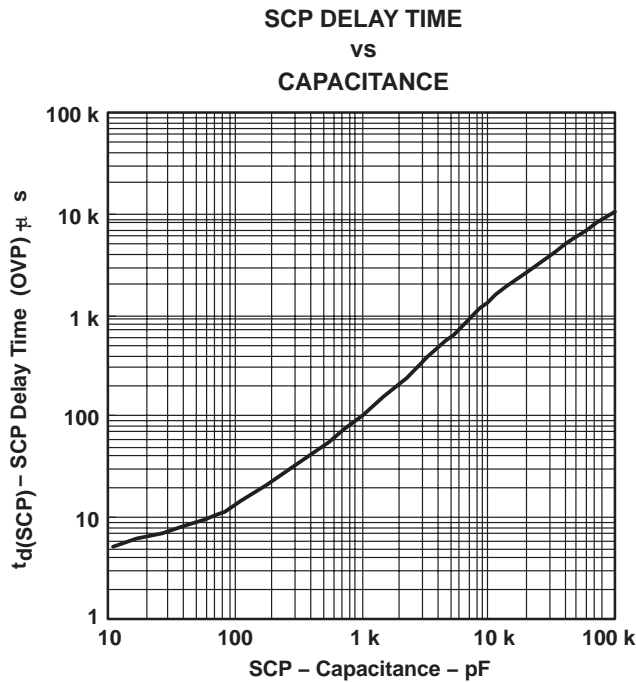
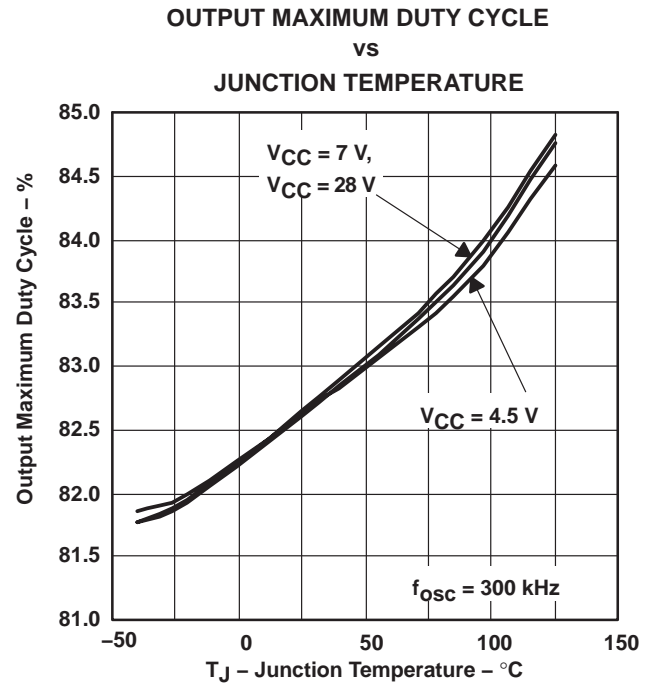
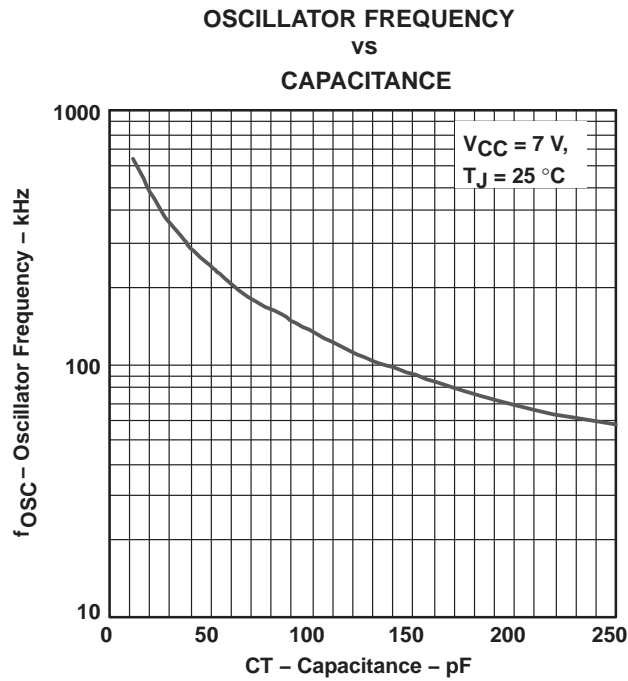

# TPS5120-Q1

## DUAL OUTPUT, TWO-PHASE SYNCHRONOUS BUCK DC/DC CONTROLLER

SGLS225B – JANUARY 2004 – REVISED APRIL 2008

### TYPICAL CHARACTERISTICS

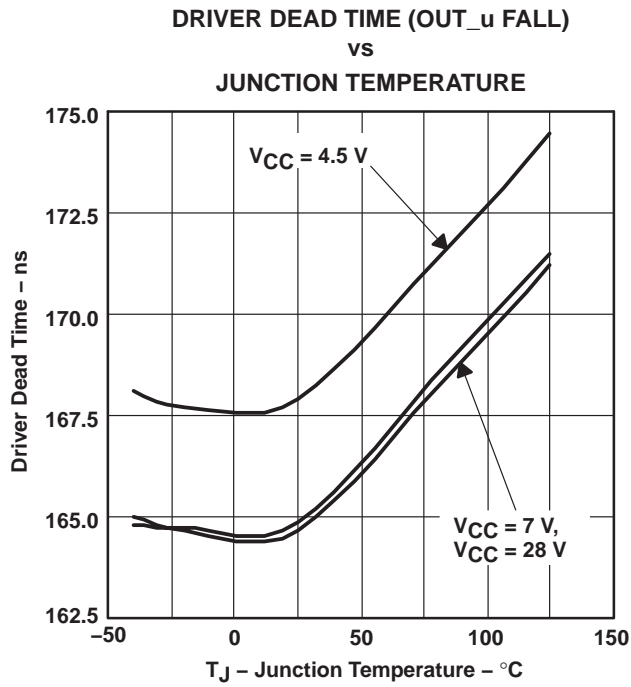

Figure 30

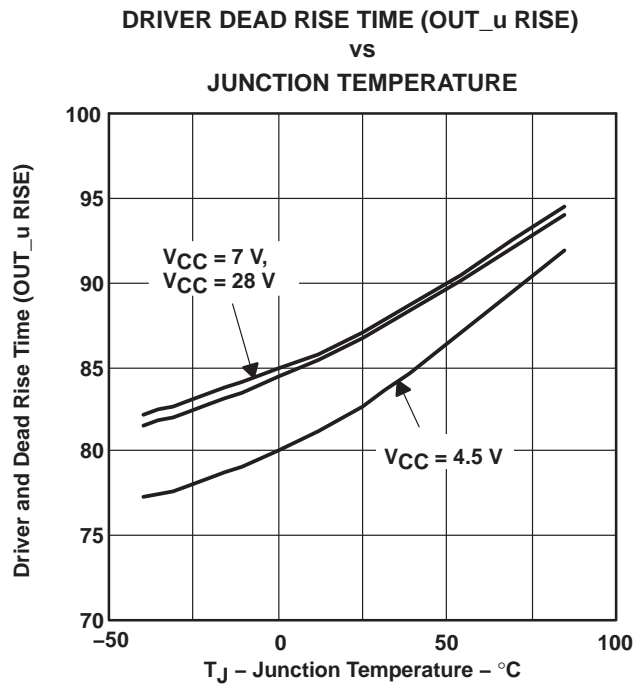

Figure 31

**PACKAGING INFORMATION**

Orderable Device	Status <sup>(1)</sup>	Package Type	Package Drawing	Pins	Package Qty	Eco Plan <sup>(2)</sup>	Lead/Ball Finish	MSL Peak Temp <sup>(3)</sup>
TPS5120QDBTRQ1	ACTIVE	TSSOP	DBT	30	2000	Green (RoHS & no Sb/Br)	CU NIPDAU	Level-2-260C-1 YEAR
TPS5120QDBTRQ1G4	ACTIVE	TSSOP	DBT	30	2000	Green (RoHS & no Sb/Br)	CU NIPDAU	Level-2-260C-1 YEAR

<sup>(1)</sup> The marketing status values are defined as follows:

**ACTIVE:** Product device recommended for new designs.

**LIFEBUY:** TI has announced that the device will be discontinued, and a lifetime-buy period is in effect.

**NRND:** Not recommended for new designs. Device is in production to support existing customers, but TI does not recommend using this part in a new design.

**PREVIEW:** Device has been announced but is not in production. Samples may or may not be available.

**OBsolete:** TI has discontinued the production of the device.

<sup>(2)</sup> Eco Plan - The planned eco-friendly classification: Pb-Free (RoHS), Pb-Free (RoHS Exempt), or Green (RoHS & no Sb/Br) - please check <http://www.ti.com/productcontent> for the latest availability information and additional product content details.

**TBD:** The Pb-Free/Green conversion plan has not been defined.

**Pb-Free (RoHS):** TI's terms "Lead-Free" or "Pb-Free" mean semiconductor products that are compatible with the current RoHS requirements for all 6 substances, including the requirement that lead not exceed 0.1% by weight in homogeneous materials. Where designed to be soldered at high temperatures, TI Pb-Free products are suitable for use in specified lead-free processes.

**Pb-Free (RoHS Exempt):** This component has a RoHS exemption for either 1) lead-based flip-chip solder bumps used between the die and package, or 2) lead-based die adhesive used between the die and leadframe. The component is otherwise considered Pb-Free (RoHS compatible) as defined above.

**Green (RoHS & no Sb/Br):** TI defines "Green" to mean Pb-Free (RoHS compatible), and free of Bromine (Br) and Antimony (Sb) based flame retardants (Br or Sb do not exceed 0.1% by weight in homogeneous material)

<sup>(3)</sup> MSL, Peak Temp. -- The Moisture Sensitivity Level rating according to the JEDEC industry standard classifications, and peak solder temperature.

**Important Information and Disclaimer:** The information provided on this page represents TI's knowledge and belief as of the date that it is provided. TI bases its knowledge and belief on information provided by third parties, and makes no representation or warranty as to the accuracy of such information. Efforts are underway to better integrate information from third parties. TI has taken and continues to take reasonable steps to provide representative and accurate information but may not have conducted destructive testing or chemical analysis on incoming materials and chemicals. TI and TI suppliers consider certain information to be proprietary, and thus CAS numbers and other limited information may not be available for release.

In no event shall TI's liability arising out of such information exceed the total purchase price of the TI part(s) at issue in this document sold by TI to Customer on an annual basis.

**OTHER QUALIFIED VERSIONS OF TPS5120-Q1 :**

- Catalog: [TPS5120](#)
- Enhanced Product: [TPS5120-EP](#)

NOTE: Qualified Version Definitions:

- Catalog - TI's standard catalog product
- Enhanced Product - Supports Defense, Aerospace and Medical Applications

DBT (R-PDSO-G30)

PLASTIC SMALL OUTLINE

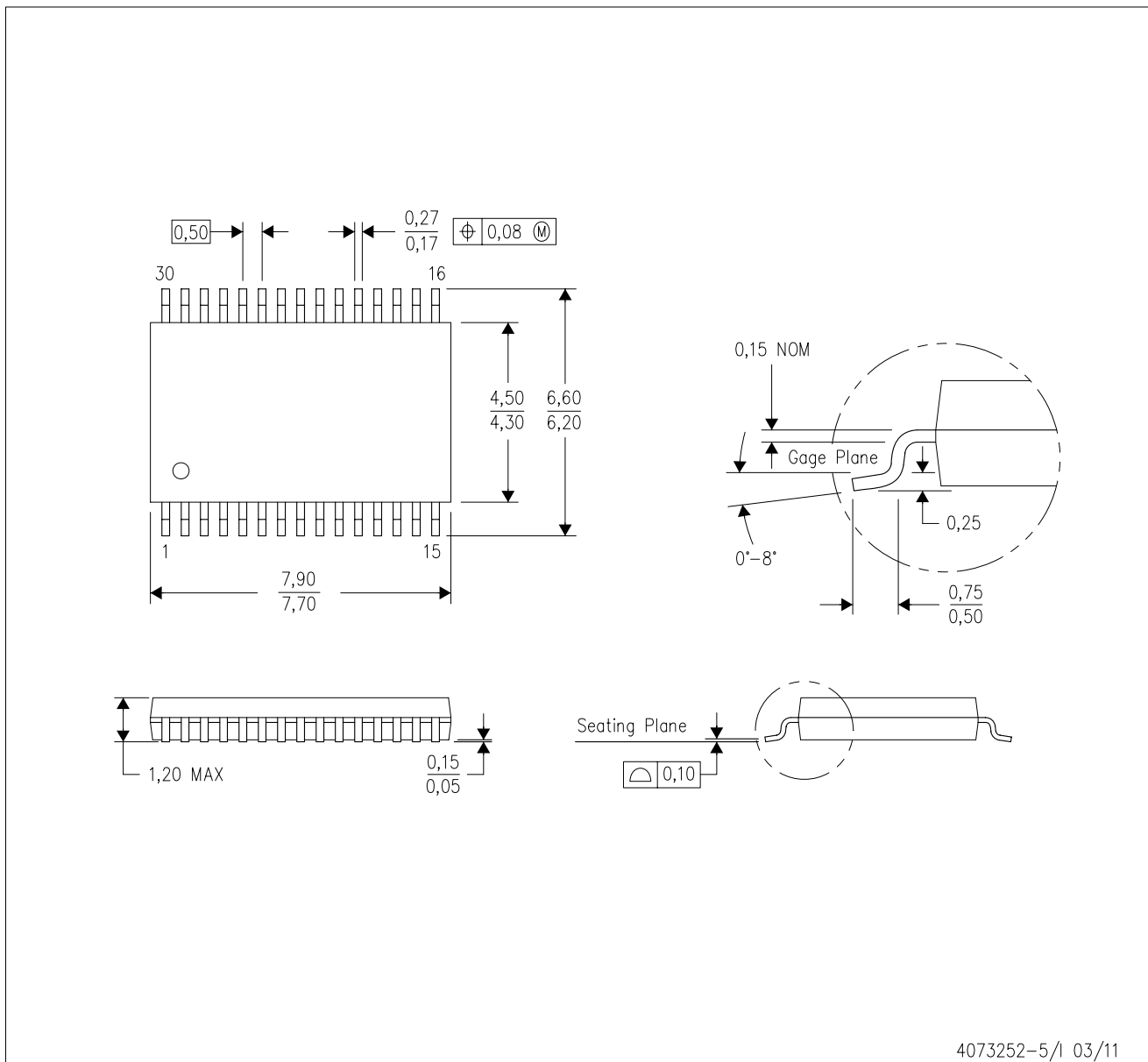

- NOTES:
- A. All linear dimensions are in millimeters. Dimensioning and tolerancing per ASME Y14.5M-1994.
  - B. This drawing is subject to change without notice.
  - C. Body dimensions do not include mold flash or protrusion.
  - D. Falls within JEDEC MO-153.

## IMPORTANT NOTICE

Texas Instruments Incorporated and its subsidiaries (TI) reserve the right to make corrections, modifications, enhancements, improvements, and other changes to its products and services at any time and to discontinue any product or service without notice. Customers should obtain the latest relevant information before placing orders and should verify that such information is current and complete. All products are sold subject to TI's terms and conditions of sale supplied at the time of order acknowledgment.

TI warrants performance of its hardware products to the specifications applicable at the time of sale in accordance with TI's standard warranty. Testing and other quality control techniques are used to the extent TI deems necessary to support this warranty. Except where mandated by government requirements, testing of all parameters of each product is not necessarily performed.

TI assumes no liability for applications assistance or customer product design. Customers are responsible for their products and applications using TI components. To minimize the risks associated with customer products and applications, customers should provide adequate design and operating safeguards.

TI does not warrant or represent that any license, either express or implied, is granted under any TI patent right, copyright, mask work right, or other TI intellectual property right relating to any combination, machine, or process in which TI products or services are used. Information published by TI regarding third-party products or services does not constitute a license from TI to use such products or services or a warranty or endorsement thereof. Use of such information may require a license from a third party under the patents or other intellectual property of the third party, or a license from TI under the patents or other intellectual property of TI.

Reproduction of TI information in TI data books or data sheets is permissible only if reproduction is without alteration and is accompanied by all associated warranties, conditions, limitations, and notices. Reproduction of this information with alteration is an unfair and deceptive business practice. TI is not responsible or liable for such altered documentation. Information of third parties may be subject to additional restrictions.

Resale of TI products or services with statements different from or beyond the parameters stated by TI for that product or service voids all express and any implied warranties for the associated TI product or service and is an unfair and deceptive business practice. TI is not responsible or liable for any such statements.

TI products are not authorized for use in safety-critical applications (such as life support) where a failure of the TI product would reasonably be expected to cause severe personal injury or death, unless officers of the parties have executed an agreement specifically governing such use. Buyers represent that they have all necessary expertise in the safety and regulatory ramifications of their applications, and acknowledge and agree that they are solely responsible for all legal, regulatory and safety-related requirements concerning their products and any use of TI products in such safety-critical applications, notwithstanding any applications-related information or support that may be provided by TI. Further, Buyers must fully indemnify TI and its representatives against any damages arising out of the use of TI products in such safety-critical applications.

TI products are neither designed nor intended for use in military/aerospace applications or environments unless the TI products are specifically designated by TI as military-grade or "enhanced plastic." Only products designated by TI as military-grade meet military specifications. Buyers acknowledge and agree that any such use of TI products which TI has not designated as military-grade is solely at the Buyer's risk, and that they are solely responsible for compliance with all legal and regulatory requirements in connection with such use.

TI products are neither designed nor intended for use in automotive applications or environments unless the specific TI products are designated by TI as compliant with ISO/TS 16949 requirements. Buyers acknowledge and agree that, if they use any non-designated products in automotive applications, TI will not be responsible for any failure to meet such requirements.

Following are URLs where you can obtain information on other Texas Instruments products and application solutions:

### Products

Audio	<a href="http://www.ti.com/audio">www.ti.com/audio</a>
Amplifiers	<a href="http://amplifier.ti.com">amplifier.ti.com</a>
Data Converters	<a href="http://dataconverter.ti.com">dataconverter.ti.com</a>
DLP® Products	<a href="http://www.dlp.com">www.dlp.com</a>
DSP	<a href="http://dsp.ti.com">dsp.ti.com</a>
Clocks and Timers	<a href="http://www.ti.com/clocks">www.ti.com/clocks</a>
Interface	<a href="http://interface.ti.com">interface.ti.com</a>
Logic	<a href="http://logic.ti.com">logic.ti.com</a>
Power Mgmt	<a href="http://power.ti.com">power.ti.com</a>
Microcontrollers	<a href="http://microcontroller.ti.com">microcontroller.ti.com</a>
RFID	<a href="http://www.ti-rfid.com">www.ti-rfid.com</a>
RF/IF and ZigBee® Solutions	<a href="http://www.ti.com/lprf">www.ti.com/lprf</a>

### Applications

Communications and Telecom	<a href="http://www.ti.com/communications">www.ti.com/communications</a>
Computers and Peripherals	<a href="http://www.ti.com/computers">www.ti.com/computers</a>
Consumer Electronics	<a href="http://www.ti.com/consumer-apps">www.ti.com/consumer-apps</a>
Energy and Lighting	<a href="http://www.ti.com/energy">www.ti.com/energy</a>
Industrial	<a href="http://www.ti.com/industrial">www.ti.com/industrial</a>
Medical	<a href="http://www.ti.com/medical">www.ti.com/medical</a>
Security	<a href="http://www.ti.com/security">www.ti.com/security</a>
Space, Avionics and Defense	<a href="http://www.ti.com/space-avionics-defense">www.ti.com/space-avionics-defense</a>
Transportation and Automotive	<a href="http://www.ti.com/automotive">www.ti.com/automotive</a>
Video and Imaging	<a href="http://www.ti.com/video">www.ti.com/video</a>
Wireless	<a href="http://www.ti.com/wireless-apps">www.ti.com/wireless-apps</a>

TI E2E Community Home Page

[e2e.ti.com](http://e2e.ti.com)

Mailing Address: Texas Instruments, Post Office Box 655303, Dallas, Texas 75265  
Copyright © 2011, Texas Instruments Incorporated