

Ultralow V_F Hyperfast Rectifier for Discontinuous Mode PFC, 15 A FRED Pt[®]

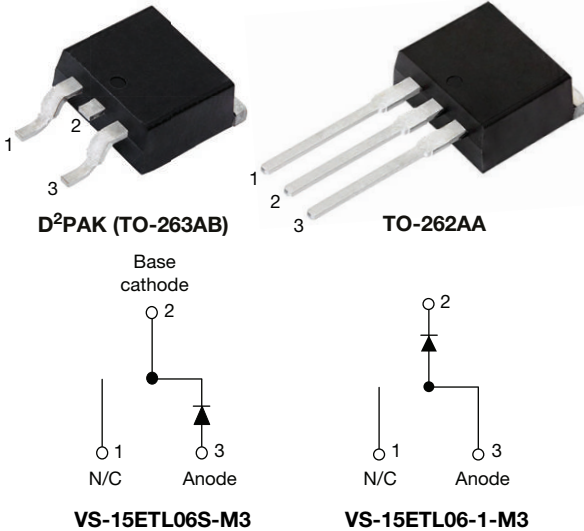

FEATURES

- Benchmark ultralow forward voltage drop
- Hyperfast recovery time
- Low leakage current
- 175 °C operating junction temperature
- Meets MSL level 1, per J-STD-020, LF maximum peak of 245 °C
- Material categorization: for definitions of compliance please see www.vishay.com/doc?99912



RoHS
COMPLIANT
HALOGEN
FREE

DESCRIPTION

State of the art, ultralow V_F , soft-switching hyperfast rectifiers optimized for Discontinuous (Critical) Mode (DCM) Power Factor Correction (PFC).

The minimized conduction loss, optimized stored charge and low recovery current minimize the switching losses and reduce over dissipation in the switching element and snubbers.

The device is also intended for use as a freewheeling diode in power supplies and other power switching applications.

APPLICATIONS

AC/DC SMPS 70 W to 400 W

e.g. laptop and printer AC adaptors, desktop PC, TV and monitor, games units and DVD AC/DC power supplies.

PRIMARY CHARACTERISTICS

$I_{F(AV)}$	15 A
V_R	600 V
V_F at I_F	0.85 V
t_{rr} (typ.)	60 ns
T_J max.	175 °C
Package	D ² PAK (TO-263AB), TO-262AA
Circuit configuration	Single

ABSOLUTE MAXIMUM RATINGS

PARAMETER	SYMBOL	TEST CONDITIONS	MAX.	UNITS
Peak repetitive reverse voltage	V_{RRM}		600	V
Average rectified forward current	$I_{F(AV)}$	$T_C = 154$ °C	15	A
Non-repetitive peak surge current	I_{FSM}	$T_J = 25$ °C	250	
Peak repetitive forward current	I_{FM}		30	
Operating junction and storage temperatures	T_J, T_{Stg}		-65 to +175	°C

ELECTRICAL SPECIFICATIONS ($T_J = 25$ °C unless otherwise specified)

PARAMETER	SYMBOL	TEST CONDITIONS	MIN.	TYP.	MAX.	UNITS
Breakdown voltage, blocking voltage	V_{BR}, V_R	$I_R = 100$ μ A	600	-	-	V
Forward voltage	V_F	$I_F = 15$ A $I_F = 15$ A, $T_J = 150$ °C	-	0.99 0.85	- 0.92	
Reverse leakage current	I_R	$V_R = V_R$ rated $T_J = 150$ °C, $V_R = V_R$ rated	-	0.1 15	10 120	μ A
Junction capacitance	C_T	$V_R = 600$ V	-	20	-	pF
Series inductance	L_S	Measured lead to lead 5 mm from package body	-	8.0	-	nH



DYNAMIC RECOVERY CHARACTERISTICS ($T_C = 25\text{ }^\circ\text{C}$ unless otherwise specified)						
PARAMETER	SYMBOL	TEST CONDITIONS	MIN.	TYP.	MAX.	UNITS
Reverse recovery time	t_{rr}	$I_F = 1\text{ A}$, $di_F/dt = 100\text{ A}/\mu\text{s}$, $V_R = 30\text{ V}$	-	60	120	ns
		$I_F = 15\text{ A}$, $di_F/dt = 100\text{ A}/\mu\text{s}$, $V_R = 30\text{ V}$	-	190	270	
		$T_J = 25\text{ }^\circ\text{C}$	-	220	-	
		$T_J = 125\text{ }^\circ\text{C}$	-	320	-	
Peak recovery current	I_{RRM}	$T_J = 25\text{ }^\circ\text{C}$	-	19	-	A
		$T_J = 125\text{ }^\circ\text{C}$	-	26	-	
Reverse recovery charge	Q_{rr}	$T_J = 25\text{ }^\circ\text{C}$	-	2.2	-	μC
		$T_J = 125\text{ }^\circ\text{C}$	-	4.3	-	

THERMAL - MECHANICAL SPECIFICATIONS						
PARAMETER	SYMBOL	TEST CONDITIONS	MIN.	TYP.	MAX.	UNITS
Maximum junction and storage temperature range	T_J, T_{Stg}		-65	-	175	$^\circ\text{C}$
Thermal resistance, junction to case per leg	R_{thJC}		-	1.0	1.3	$^\circ\text{C}/\text{W}$
Thermal resistance, junction to ambient per leg	R_{thJA}	Typical socket mount	-	-	70	
Thermal resistance, case to heatsink	R_{thCS}	Mounting surface, flat, smooth and greased	-	0.5	-	
Weight			-	2.0	-	g
			-	0.07	-	oz.
Mounting torque			6.0 (5.0)	-	12 (10)	kgf · cm (lbf · in)
Marking device		Case style D ² PAK (TO-263AB)	15ETL06S			
		Case style TO-262AA	15ETL06-1			

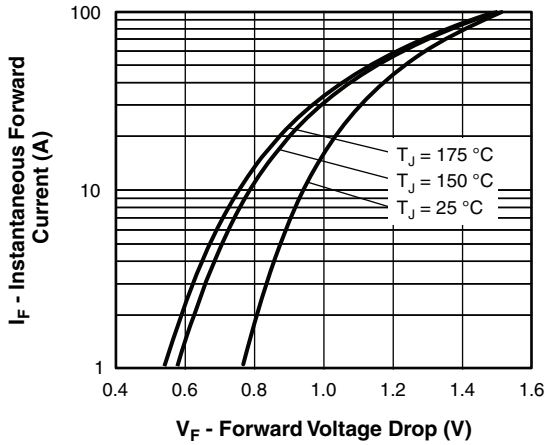

Fig. 1 - Typical Forward Voltage Drop Characteristics

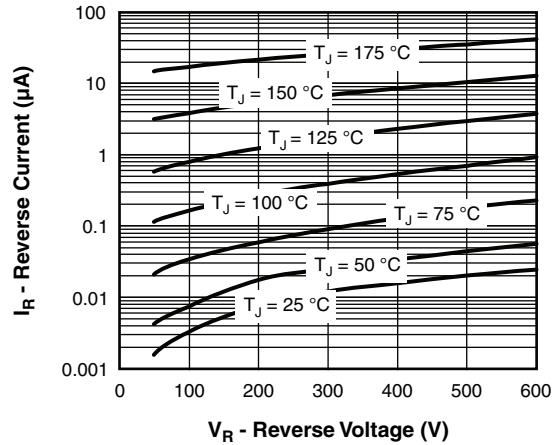

Fig. 2 - Typical Values of Reverse Current vs. Reverse Voltage

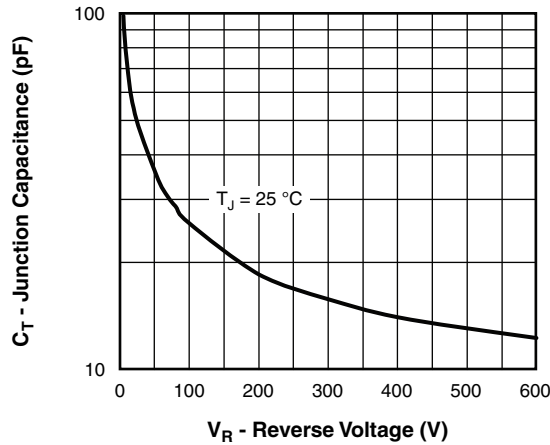

Fig. 3 - Typical Junction Capacitance vs. Reverse Voltage

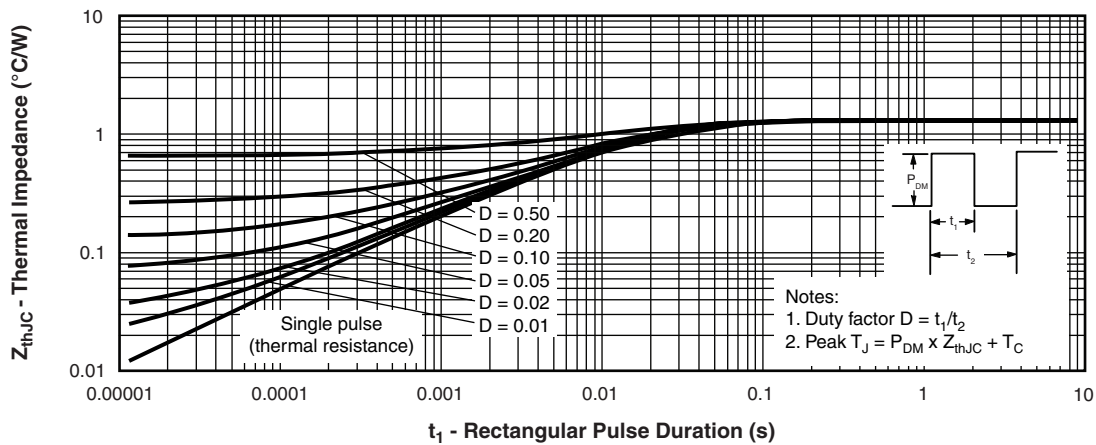

Fig. 4 - Maximum Thermal Impedance Z_{thJC} Characteristics

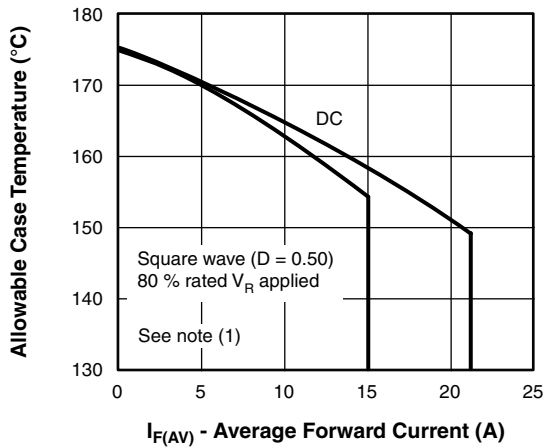

Fig. 5 - Maximum Allowable Case Temperature vs. Average Forward Current

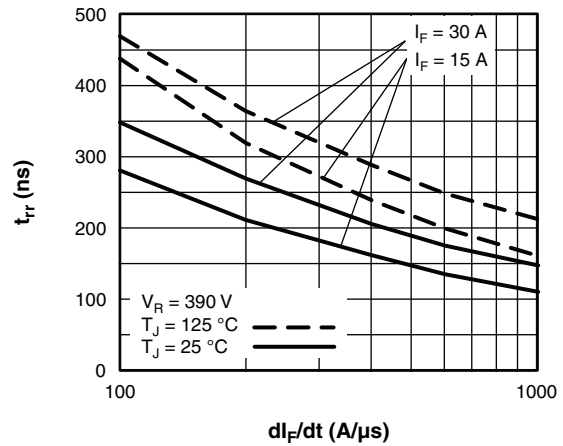

Fig. 7 - Typical Reverse Recovery Time vs. di/dt

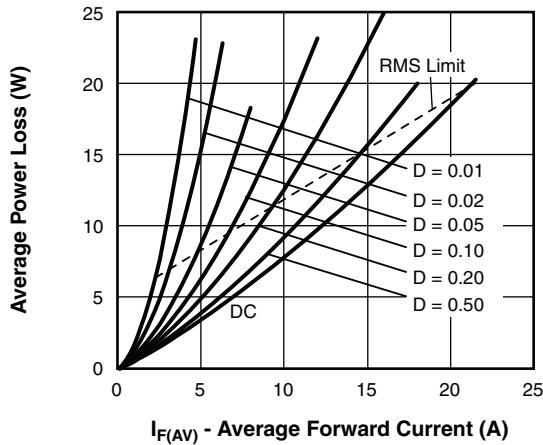

Fig. 6 - Forward Power Loss Characteristics

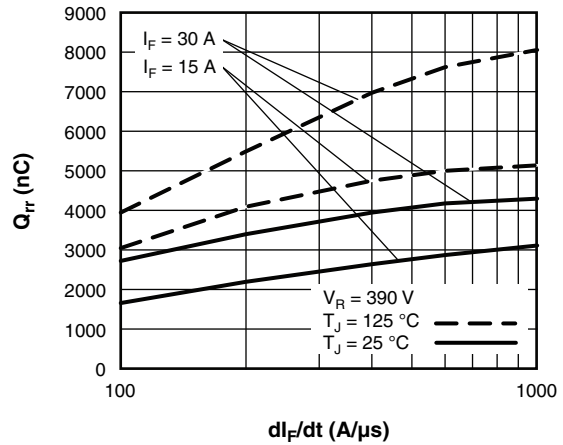
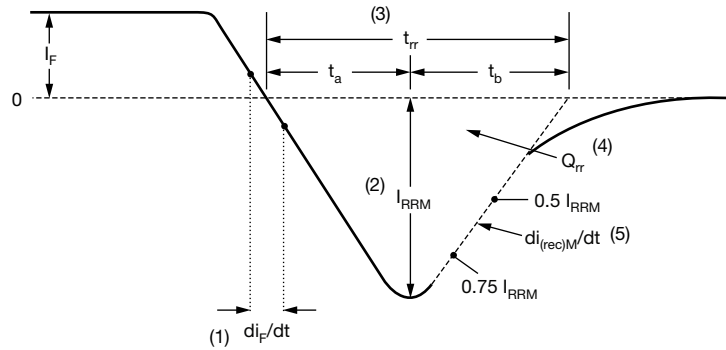

Fig. 8 - Typical Stored Charge vs. di/dt

Note

- (1) Formula used: $T_C = T_J - (P_d + P_{d_{REV}}) \times R_{thJC}$;
- P_d = forward power loss = $I_{F(AV)} \times V_{FM}$ at $(I_{F(AV)}/D)$ (see fig. 6);
- $P_{d_{REV}}$ = inverse power loss = $V_{R1} \times I_R (1 - D)$; I_R at V_{R1} = rated V_R



- (1) di_F/dt - rate of change of current through zero crossing
- (2) I_{RRM} - peak reverse recovery current
- (3) t_{rr} - reverse recovery time measured from zero crossing point of negative going I_F to point where a line passing through $0.75 I_{RRM}$ and $0.50 I_{RRM}$ extrapolated to zero current.
- (4) Q_{rr} - area under curve defined by t_{rr} and I_{RRM}
- $$Q_{rr} = \frac{t_{rr} \times I_{RRM}}{2}$$
- (5) $di_{(rec)M}/dt$ - peak rate of change of current during t_b portion of t_{rr}

Fig. 9 - Reverse Recovery Waveform and Definitions

ORDERING INFORMATION TABLE

Device code	VS-	15	E	T	L	06	S	TRL	-M3
	①	②	③	④	⑤	⑥	⑦	⑧	⑨

- 1** - Vishay Semiconductors product
- 2** - Current rating (15 A)
- 3** - E = single diode
- 4** - T = TO-220, D²PAK (TO-263AB)
- 5** - L = ultralow V_F hyperfast recovery
- 6** - Voltage rating (06 = 600 V)
- 7** -
 - S = D²PAK (TO-263AB)
 - -1 = TO-262AA
- 8** -
 - None = tube (50 pieces)
 - TRL = tape and reel (left oriented, for D²PAK (TO-263AB) package)
 - TRR = tape and reel (right oriented, for D²PAK (TO-263AB) package)
- 9** - Environmental digit:
 - M3 = halogen-free, RoHS-compliant, and terminations lead(Pb)-free

ORDERING INFORMATION (Example)		
PREFERRED P/N	BASE QUANTITY	PACKAGING DESCRIPTION
VS-15ETL06S-M3	50	Antistatic plastic tubes
VS-15ETL06STRL-M3	800	13" diameter plastic tape and reel
VS-15ETL06STRR-M3	800	13" diameter plastic tape and reel
VS-15ETL06-1-M3	50	Antistatic plastic tubes



LINKS TO RELATED DOCUMENTS		
Dimensions	D ² PAK (TO-263AB)	www.vishay.com/doc?96164
	TO-262AA	www.vishay.com/doc?96165
Part marking information	D ² PAK (TO-263AB)	www.vishay.com/doc?95444
	TO-262AA	www.vishay.com/doc?95443
Packaging information		www.vishay.com/doc?96424
SPICE model		www.vishay.com/doc?96051

D²PAK

DIMENSIONS in millimeters and inches

Conforms to JEDEC[®] outline D²PAK (SMD-220)



SYMBOL	MILLIMETERS		INCHES		NOTES	SYMBOL	MILLIMETERS		INCHES		NOTES
	MIN.	MAX.	MIN.	MAX.			MIN.	MAX.	MIN.	MAX.	
A	4.06	4.83	0.160	0.190		D1	6.86	8.00	0.270	0.315	3
A1	0.00	0.254	0.000	0.010		E	9.65	10.67	0.380	0.420	2, 3
b	0.51	0.99	0.020	0.039		E1	7.90	8.80	0.311	0.346	3
b1	0.51	0.89	0.020	0.035	4	e	2.54 BSC		0.100 BSC		
b2	1.14	1.78	0.045	0.070		H	14.61	15.88	0.575	0.625	
b3	1.14	1.73	0.045	0.068	4	L	1.78	2.79	0.070	0.110	
c	0.38	0.74	0.015	0.029		L1	-	1.65	-	0.066	3
c1	0.38	0.58	0.015	0.023	4	L2	1.27	1.78	0.050	0.070	
c2	1.14	1.65	0.045	0.065		L3	0.25 BSC		0.010 BSC		
D	8.51	9.65	0.335	0.380	2	L4	4.78	5.28	0.188	0.208	

Notes

- (1) Dimensioning and tolerancing per ASME Y14.5 M-1994
- (2) Dimension D and E do not include mold flash. Mold flash shall not exceed 0.127 mm (0.005") per side. These dimensions are measured at the outmost extremes of the plastic body
- (3) Thermal pad contour optional within dimension E, L1, D1 and E1
- (4) Dimension b1 and c1 apply to base metal only
- (5) Datum A and B to be determined at datum plane H
- (6) Controlling dimension: inches
- (7) Outline conforms to JEDEC[®] outline TO-263AB

TO-262AA

DIMENSIONS in millimeters and inches

Modified JEDEC® outline TO-262

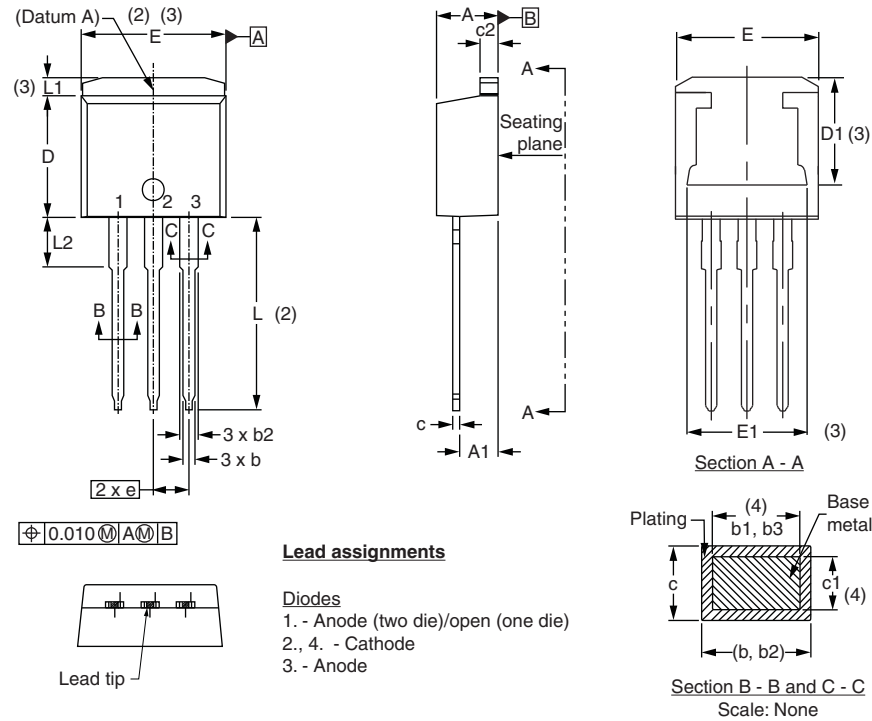

SYMBOL	MILLIMETERS		INCHES		NOTES
	MIN.	MAX.	MIN.	MAX.	
A	4.06	4.83	0.160	0.190	
A1	2.03	3.02	0.080	0.119	
b	0.51	0.99	0.020	0.039	
b1	0.51	0.89	0.020	0.035	4
b2	1.14	1.78	0.045	0.070	
b3	1.14	1.73	0.045	0.068	4
c	0.38	0.74	0.015	0.029	
c1	0.38	0.58	0.015	0.023	4
c2	1.14	1.65	0.045	0.065	
D	8.51	9.65	0.335	0.380	2
D1	6.86	8.00	0.270	0.315	3
E	9.65	10.67	0.380	0.420	2, 3
E1	7.90	8.80	0.311	0.346	3
e	2.54 BSC		0.100 BSC		
L	13.46	14.10	0.530	0.555	
L1	-	1.65	-	0.065	3
L2	3.56	3.71	0.140	0.146	

Notes

- (1) Dimensioning and tolerancing as per ASME Y14.5M-1994
- (2) Dimension D and E do not include mold flash. Mold flash shall not exceed 0.127 mm (0.005") per side. These dimensions are measured at the outmost extremes of the plastic body
- (3) Thermal pad contour optional within dimension E, L1, D1 and E1
- (4) Dimension b1 and c1 apply to base metal only
- (5) Controlling dimension: inches
- (6) Outline conform to JEDEC® TO-262 except A1 (max.), b (min., max.), b1 (min.), b2 (max.), c (min.), c1(min.), c2 (max.), D (min.), E (max.), L1 (max.), L2 (min., max.)



Disclaimer

ALL PRODUCT, PRODUCT SPECIFICATIONS AND DATA ARE SUBJECT TO CHANGE WITHOUT NOTICE TO IMPROVE RELIABILITY, FUNCTION OR DESIGN OR OTHERWISE.

Vishay Intertechnology, Inc., its affiliates, agents, and employees, and all persons acting on its or their behalf (collectively, "Vishay"), disclaim any and all liability for any errors, inaccuracies or incompleteness contained in any datasheet or in any other disclosure relating to any product.

Vishay makes no warranty, representation or guarantee regarding the suitability of the products for any particular purpose or the continuing production of any product. To the maximum extent permitted by applicable law, Vishay disclaims (i) any and all liability arising out of the application or use of any product, (ii) any and all liability, including without limitation special, consequential or incidental damages, and (iii) any and all implied warranties, including warranties of fitness for particular purpose, non-infringement and merchantability.

Statements regarding the suitability of products for certain types of applications are based on Vishay's knowledge of typical requirements that are often placed on Vishay products in generic applications. Such statements are not binding statements about the suitability of products for a particular application. It is the customer's responsibility to validate that a particular product with the properties described in the product specification is suitable for use in a particular application. Parameters provided in datasheets and / or specifications may vary in different applications and performance may vary over time. All operating parameters, including typical parameters, must be validated for each customer application by the customer's technical experts. Product specifications do not expand or otherwise modify Vishay's terms and conditions of purchase, including but not limited to the warranty expressed therein.

Hyperlinks included in this datasheet may direct users to third-party websites. These links are provided as a convenience and for informational purposes only. Inclusion of these hyperlinks does not constitute an endorsement or an approval by Vishay of any of the products, services or opinions of the corporation, organization or individual associated with the third-party website. Vishay disclaims any and all liability and bears no responsibility for the accuracy, legality or content of the third-party website or for that of subsequent links.

Except as expressly indicated in writing, Vishay products are not designed for use in medical, life-saving, or life-sustaining applications or for any other application in which the failure of the Vishay product could result in personal injury or death. Customers using or selling Vishay products not expressly indicated for use in such applications do so at their own risk. Please contact authorized Vishay personnel to obtain written terms and conditions regarding products designed for such applications.

No license, express or implied, by estoppel or otherwise, to any intellectual property rights is granted by this document or by any conduct of Vishay. Product names and markings noted herein may be trademarks of their respective owners.